

FOCUS 35 Total Station

User Guide



Corporate Office

Spectra Geospatial
10368 Westmoor Drive
Westminster, CO 80021, USA

+1-720-587-4700 Phone
888-477-7516 (Toll free in USA)
www.spectrageospatial.com

Copyright and trademarks

© 2015–2019, Trimble Inc. All rights reserved.

Spectra Geospatial is a division of Trimble Inc. Spectra, the Spectra Geospatial logo, and FOCUS are trademarks of Trimble Inc., registered in the United States and in other countries. GeoLock, LockNGo, Ranger, T41, StepDrive, and SurveyPro are trademarks of Trimble Inc.

Microsoft, Windows, Windows Mobile, and Windows Vista, are either registered trademarks or trademarks of Microsoft Corporation in the United States and/or other countries. The Bluetooth word mark and logos are owned by the Bluetooth SIG, Inc. and any use of such marks by Trimble Inc. is under license. All other trademarks are the property of their respective owners.

Release Notice

This is the August 2019 release (Revision A) of the FOCUS 35 Total Station User Guide. It applies to version 2.00 of the software.

Product Limited Warranty Information

For applicable product Limited Warranty information, please refer to the Limited Warranty Card included with this product, or consult your local Spectra Geospatial authorized dealer.

Updates and new products

To obtain information regarding updates and new products, contact your Spectra Geospatial distributor or visit the Spectra Geospatial website at www.spectrageospatial.com.

Notices

Australia and New Zealand

This product complies with the regulatory requirements of the Australian Communications and Media Authority (ACMA) EMC framework, thus satisfying the requirements for RCM-Marking and sale within Australia and New Zealand.



Canada

This device complies with Industry Canada license-exempt RSS standard(s). Operation is subject to the following two conditions:

- (1) this device may not cause interference, and
- (2) this device must accept any interference, including interference that may cause undesired operation of the device.

Le présent appareil est conforme aux CNR d'Industrie Canada applicables aux appareils radio exempts de licence. L'exploitation est autorisée aux deux conditions suivantes:

- (1) l'appareil ne doit pas produire de brouillage, et
- (2) l'utilisateur de l'appareil doit accepter tout brouillage radioélectrique subi, même si le brouillage est susceptible d'en compromettre le fonctionnement.

This device has been designed to operate with an antenna having a maximum gain of 2.0 dBi. Antenna having a higher gain is strictly prohibited per regulations of Industry Canada. The required antenna impedance is 50 ohms. To reduce potential radio interference to other users, the antenna type and its gain should be so chosen that the equivalent isotropically radiated power (EIRP) is not more than that required for successful communication. Operation is subject to the following two conditions: (1) this device may not cause interference, and (2) this device must accept any interference, including interference that may cause undesired operation of the device.

Devices marked with Part Numbers 78731035 (78431035), 78732035 (78432035), 78733035 (78433035), 78735035 (78435035), 78742035 (78542035), 78743035 (78543035), and 78745035 (78545035) contain radio module with IC: 4492A-2410G.

The devices marked with Part Numbers 78733035 (78433035), 78735035 (78435035), 78751035 (78441035), 78752035 (78442035), 78753035 (78443035) and 78755035 (78445035) contains a Bluetooth radio module with IC: 6100 NM230NF.

Europe

This product has been tested and found to comply with relevant requirements pursuant to European Council directives, thereby satisfying the requirements for CE marking and sale within the European Economic Area (EEA).

Applicable directives:

RED Directive 2014/53/EU

RoHS Directive 2011/65/EU

The compliance to the applicable requirements is detailed in the official Declaration of Conformity document, which is filed at Spectra Geospatial.

For product recycling instructions and more information, please go to www.spectrageospatial.com/weee-and-rohs/

Recycling in Europe: To recycle Spectra Geospatial WEEE (Waste Electrical and Electronic Equipment, products that run on electrical power.), Call +31 497 53 24 30, and ask for the "WEEE Associate". Or, mail a request for recycling instructions to:

Spectra Geospatial Europe BV
c/o Menlo Worldwide Logistics
Meerheide 45
5521 DZ Eersel, NL



USA

Note: This equipment has been tested and found to comply with the limits for a Class A digital device, pursuant to part 15 of the FCC Rules. These limits are designed to provide reasonable protection against harmful interference when the equipment is operated in a commercial environment. This equipment generates, uses, and can radiate radio frequency energy and, if not installed and used in accordance with the instruction manual, may cause harmful interference to radio communications.

Operation of this equipment in a residential area is likely to cause harmful interference in which case the user will be required to correct the interference at his own expense.

Changes and modifications not expressly approved by the manufacturer or registrant of this equipment can void your authority to operate this equipment under Federal Communications Commission rules

The antenna used for this transmitter must be installed to provide a separation distance of at least 20 cm from all persons and must not be co-located or operating in conjunction with any other antenna or transmitter:

Devices marked with Part Numbers 78731035 (78431035), 78732035 (78432035), 78733035 (78433035),

78735035 (78435035), 78742035 (78542035), 78743035 (78543035), and 78745035 (78545035) contain radio module with FCC ID: HSW- 2410G.

The devices marked with Part Numbers 78731035 (78431035), 78732035 (78432035), 78733035 (78433035), 78735035 (78435035), 78751035 (78441035), 78752035 (78442035), 78753035 (78443035), and 78755035 (78445035) contains a Bluetooth radio module with FCC ID: TLZ-NM230NF.

This device complies with Part 15 of the FCC rules. Operation is subject to the following two conditions:

- (1) This device may not cause harmful interference, and
- (2) This device must accept any interference received, including interference that may cause undesired operation.

Taiwan

Battery Recycling Requirements. The product contains a removable Lithium-ion battery.

Taiwanese regulations require that waste batteries are recycled.



Important Information

Before using the Spectra® Geospatial FOCUS® 35 total station, make sure that you understand this user guide, as well as all equipment and job site safety requirements.

Safety Information

- Instruments and original accessories from Spectra Geospatial must only be used for the intended purpose.
- Operate the instrument only in compliance with the operating conditions specified. Do not point the telescope directly at the sun.
- Do not use the instrument and accessories in rooms with danger of explosion.
- Protect operator and instrument sufficiently at the site of measurement (e.g., construction site, roads, etc.). Observe any relevant national regulations and the Road Traffic Act.
- Do not carry out surveying work in a thunderstorm to avoid being struck by lightning.
- Do not modify the instrument.
- Do not use the instrument if there are any visible damages.
- Only authorized Spectra Geospatial service centers have permission to repair this product.

Laser Safety

This equipment has been tested and found to comply with IEC 60825-1:2014 and IEC 60825-1:2007 and 21 CFR 1040.10 and 1040.11 except for deviations pursuant to Laser Notice No. 50, dated July 26, 2007.

WARNING – Use of controls or adjustments or performance of procedures other than those specified herein may result in hazardous LED or laser radiation exposure. As with any bright light source, such as the sun, electric welding arcs or arc lamps, common sense applies. DO NOT look into the laser aperture when the laser is on. For further information regarding laser safe use of laser, refer to IEC standard 60825-1:2014.

NOTE – For security reasons the Spectra Geospatial FOCUS 35 User Guide describes the warnings and regulations of the IEC 60825-1:2014 and the warnings and recommendations of the German industrial regulation BGV B2 (updated print version April 2007).

In accordance with this German regulation, a responsible person must be identified for laser safety. All absolute vital power to fulfill this task has to be transferred to this person.

Please ensure that you are aware of any national laws and regulations applicable in the country of operation, concerning laser safety precautions and any other occupational safety and health issues that

may be encountered. All national laws and regulations take precedence over foreign or international standards.

Laser Safety Questions

Address any questions you may have about laser safety to:

Spectra Geospatial
5475 Kellenburger Road
Dayton, OH USA 45424-1099
Attention: Laser Safety Officer, Quality Assurance Group
Phone (937) 233-8921 ext 824 or (800) 538-7800
Fax (937) 233-9661

CLASS 3R Laser Product

The FOCUS 35 Total Station is a CLASS 3R LASER PRODUCT and contains different light sources.

Distance Measurement and Laser Pointer

The Distance Measuring Unit in reflectorless mode and in Laser Pointer mode produces visible Laser light emerging at the centre of the telescope objective. Product conforms to Class 3R in accordance with IEC 60825-1:2014 and IEC 60825-1:2007 "Safety of laser devices". The product complies with FDA 21CFR1040.10 and 1040.11.

Beam divergence	0.4 mrad
Modulation frequency	400 MHz*
Max. Output power	<5 mW
Wavelength	660 nm
Measuring uncertainty	±5%

*Not valid for Laser Pointer

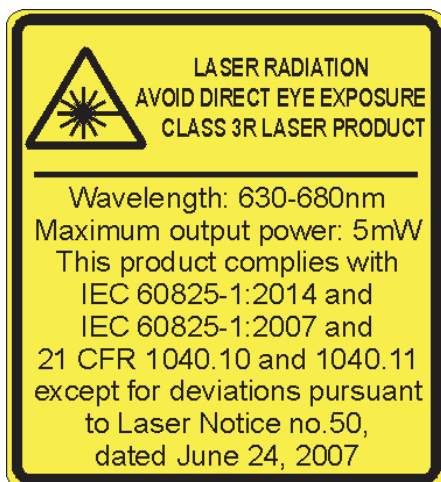

WARNING – The use of Laser Class 3R equipment can be dangerous for the eyes. The risk for eye damage is minimized through the radiation limit of 5 mW (FOCUS 35 at 660 nm).

Do not stare directly into the beam.

Do not direct the beam towards reflective surfaces (prisms, mirrors, metallic surfaces, or windows) or towards other people.

Precautions should be taken to ensure that persons do not look with an optical instrument directly into the beam.

Dazzle flash-blindness and afterimages may be caused by a beam from a Class 3R laser product, particularly under low ambient light conditions. This may result in temporary disturbance of vision.

Do not operate any equipment or vehicles if such disturbance of vision occurs.

In a distance of 80 m (262 ft) from an instrument the radiation conforms to Laser Class 1. In Laser Class 1 a direct intrabeam viewing is not hazardous.

Take the following precautions while using a Class 3R instrument in order to minimize the risks of personal injury:

- Only use the instrument's Laser Class 3R function when absolutely necessary.
- Set up the laser beam above or below human eye level wherever practicable.
- Make sure that the area where the Class 3R instruments are used is marked with appropriate laser warning signs.
- Do not measure towards prisms up to 1,000 m (3,280 ft) in reflectorless mode.
- Make sure that unauthorized personnel do not get access to the instrument.

The Distance Measuring Unit in prism mode produces visible laser light emerging at the center of the telescope objective. Product conforms to Class 1 in accordance with IEC 60825-1:2014 and IEC 60825-1:2007 "Safety of laser devices".

Max. output power < 20 μ W

CLASS 1 LASER PRODUCT

WARNING – Class 1 laser products are safe in normal use under reasonable conditions of operation and are not harmful to the eyes provided that the products are used and maintained in accordance with the instructions.

Tracklight

Tracklight produces visible LED light emerging from an objective above/below the telescope objective. LEDs are not in scope of IEC 60825-1:2014 "Safety of laser devices". Product is in accordance with IEC 62471: 2006.

Beam divergence	70 mrad
Max. output power	0.4 mW (red) and 0.2 mW (green)
Wavelength	645 nm (red) and 520 nm (green)
Measuring uncertainty	± 5%

LockNGo Tracker

The LockNGo™ Tracker produces an invisible laser beam emerging at the center of the telescope objective. Conforms to Class 1 in accordance with IEC 60825-1:2014 and IEC 60825-1:2007 "Safety of laser devices". The product complies with FDA 21CFR1040.10 and 1040.11.

Beam divergence (Hz x V)	40 mrad x 30 mrad
Pulse duration	144 μs
Max. pulse frequency	109 Hz
Max. Peak Power	2.22 mW
Max. Mean Power	0.035 mW
Wavelength	850 nm
Measuring uncertainty	± 5%

For instrument labeling, see [Laser Information, page 41](#).

Battery Safety

WARNING – Do not damage the rechargeable Lithium-ion battery. A damaged battery can cause an explosion or fire, and can result in personal injury and/or property damage. To prevent injury or damage:

- Do not use or charge the battery if it appears to be damaged. Signs of damage include, but are not limited to, discoloration, warping, and leaking battery fluid.
- Do not expose the battery to fire, high temperature, or direct sunlight.
- Do not immerse the battery in water.
- Do not use or store the battery inside a vehicle during hot weather.
- Do not drop or puncture the battery.
- Do not open the battery or short-circuit its contacts.

WARNING – Avoid contact with the rechargeable lithium-ion battery if it appears to be leaking. Battery fluid is corrosive, and contact with it can result in personal injury and/or property damage. To prevent injury or damage:

- If the battery leaks, avoid contact with the battery fluid.
- If the battery fluid gets into your eyes, immediately rinse your eyes with clean water and seek medical attention. Do not rub your eyes!
- If battery fluid gets onto your skin or clothing, immediately use clean water to wash off the battery fluid.

WARNING – Charge and use the rechargeable Lithium-ion battery only in strict accordance with the instructions. Charging or using the battery in unauthorized equipment can cause an explosion or fire, and can result in personal injury and/or equipment damage. To prevent injury or damage:

- Do not charge or use the battery if it appears to be damaged or leaking.
- Charge the lithium-ion battery only in a Spectra Geospatial product that is specified to charge it. Be sure to follow all instructions that are provided with the battery charger.
- Discontinue charging a battery that gives off extreme heat or a burning odor.
- Use the battery only in Spectra Geospatial equipment that is specified to use it.
- Use the battery only for its intended use and according to the instructions in the product documentation.

Environmental Information

NOTICE FOR EUROPEAN UNION CUSTOMERS

Spectra Geospatial is pleased to announce a new recycling program for our European Union customers. We recognize the importance of minimizing the environmental impacts of our products and we endeavor to meet your needs, not only when you purchase and use our products, but also when you are ready to dispose of them. That is why Spectra Geospatial is actively pursuing, and will continue to pursue, the expanded use of environment friendly materials in all its products, and why we have established a convenient and environmentally friendly recycling program.



As Spectra Geospatial makes additional recycling facilities available for your use, we will post their locations and contact information to our Recycling Instructions web page.

For product recycling instructions and more information, please go to www.spectrageospatial.com/weee-and-rohs.

To recycle Spectra Geospatial WEEE in Europe, do one of the following:

Call +31 497 53 2430, and ask for the “WEEE Associate”

Mail a request for recycling instructions to:

Spectra Geospatial
c/o Menlo Worldwide Logistics
Meerheide 45
5521 DZ Eersel, NL

Contents

Important Information	4
Safety Information	4
Laser Safety	4
Laser Safety Questions	5
CLASS 3R Laser Product	5
Distance Measurement and Laser Pointer	5
Tracklight	7
LockNGo Tracker	7
Battery Safety	8
Environmental Information	9
1 Introduction	14
Related Information	14
Technical Assistance	14
Product Registration	14
2 Inspection, Care, and Maintenance	15
Inspecting the Container	15
Instrument Case	16
Instrument Case Contents	16
Instrument Versions	18
Care and Maintenance	18
Cleaning	19
Care of the Screens	19
Applying a Screen Protector for the Face 1 Screen (if fitted)	20
Removing Moisture	20
Transporting the Instrument	20
Servicing	20
3 Getting Started	21
Power Supply	22
Battery Safety and Environment Information	22
Checking the Instrument Battery Power Supply	23
Charging the Instrument Batteries	23
Inserting the Main Battery	24
Inserting the Face 1 Battery (if Available)	25
Suspend Mode	26
Instrument Description	27
Optical Plummet	29
Trigger Key	30

Control Unit Face1 (if fitted)	30
Control Functions Control Unit Face1	31
Operating System	31
Data Storage	31
Entering Information	32
Input Panel menu	32
Touch Screen	33
Control Unit Face2	34
Telescope Lens rain cover / sun shade	35
Connecting the Instrument to an Office Computer	36
Transferring Data Files	36
Setting Up and Running ActiveSync technology	37
Troubleshooting Windows Mobile Device Center Connection Issues	40
Install and enable .NET Framework 3.5	40
Registry Changes	40
Disconnecting ActiveSync	41
Laser Information	41
FOCUS 35 Total Station	42
4 Setup	45
Setup	46
Setup Stability	46
Measurement Stability	47
Starting the Instrument	47
Starting and Settings via Face1 Control Unit (if fitted)	48
First Steps in the Survey Pro software	49
Lookup and register the Survey Pro Software	50
Survey Pro Version Number	52
Starting and Settings via Face2 Control Unit	54
Security	57
PIN code	57
Activating or changing the PIN code	57
Using the PIN code to unlock the instrument	57
PUK code	58
Face2 Display while using the Survey Pro Software in different Instrument Versions	58
Brightness and Contrast	59
Main Menu Face2 - Information and Settings	60
Instrument Adjustment and Calibration	68
Compensator	69
Optical (HA/VA) Collimation and Trunnion Axis Tilt	69
LockNGo Tracker	69
Adjustment Routines in Survey Pro software (if available)	70
The Laser Pointer	72
Optical Plummet	77
Tribrach Circular Level	79

Measuring the Instrument Height	80
Pre Measurement Check List	82
Connecting to an External Data Collector	82
Connecting with Cable - LockNGo Instrument Version	82
Connecting with Bluetooth wireless technology - LockNGo Instrument Version	83
Connecting with Radio - Robotic and RX Instrument Versions	83
5 Instrument Operational Methods	84
Conventional Measurements with StepDrive Motor System	85
LockNGo Measurement	85
GeoLock Technology	85
Robotic Measurement	85
6 Instrument Technology	86
Angle Measuring Technology	87
Correction for Mislevelment	87
Correction for Collimation Errors	87
Correction for Trunnion Axis	89
Averaging Measurements to Reduce Sighting Errors	89
Distance Measuring Technology	90
Beam Divergence	91
Tracklight	93
StepDrive Motor System and Focus System	94
StepDrive	95
LockNGo Tracking Technology	97
Power Management	97
Instrument	98
Robotic Configuration	99
Power Supply	99
Internal Power Supply	99
Second Internal Power Supply	99
External Power Supply	99
External Communication	100
Radio	100
Bluetooth wireless technology	100
7 Accessories and Options	101
Rod and Prisms	102
Spectra Geospatial Standard Rod	102
Spectra Geospatial 360 Degree Prism	103
Robotic Components	103
External Radio	104
Cables for External Power Supply and Data Transfer	105
Cable for External Power Supply	105
Cable for Data Transfer	105

Control Unit Screen Protector	107
Transport Case Accessories	108
Carrying Straps	108

Introduction

- ▶ [Related Information](#)
- ▶ [Technical Assistance](#)
- ▶ [Product Registration](#)

Welcome to the *Spectra Geospatial FOCUS 35 Total Station User Guide*. This manual describes how to set up and use the Spectra® Geospatial FOCUS® 35 total station. Even if you have used an optical Total Station before, Spectra Geospatial recommends that you spend some time reading this manual to learn about the special features of this product.

Related Information

For more information about this product, please visit our web site at www.spectrageospatial.com.

Technical Assistance

If you have a problem and cannot find the information you need in the product documentation, contact your local distributor.

Product Registration

To obtain information regarding updates and new products, contact your local Spectra Geospatial distributor, or go to the Spectra Geospatial website, www.spectrageospatial.com.

Inspection, Care, and Maintenance

- ▶ Inspecting the Container
- ▶ Instrument Case
- ▶ Care and Maintenance
- ▶ Transporting the Instrument
- ▶ Servicing

Inspecting the Container

Inspect the shipping container. If the container arrives in poor condition, examine the equipment for visible damage. If damage is found, immediately notify the carrier and your Spectra Geospatial sales representative. Keep the container and the packing material for the carrier to inspect.

Instrument Case

When unpacking the instrument, check that all ordered items are received. Below is an example of where all items can be placed in the instrument case.

Instrument Case Contents

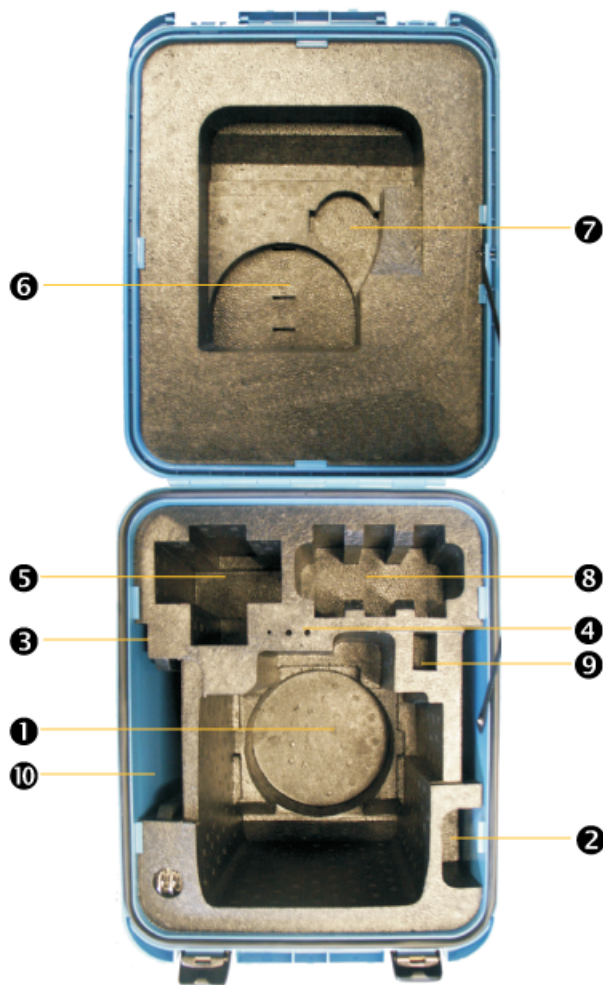

-
- ❶ FOCUS 35 instrument
 - ❷ Instrument rain cover
 - ❸ Warranty Card, WEEE information, Certificate
 - ❹ Allen key for optical plummet (1.3 mm), Allen key for EDM/Coarse sight (1.5 mm) and adjustment key for tribrach bubble
 - ❺ Data Collector¹
-

-
- ⑥ Cable between instrument and computer¹; Cable between instrument and USB flash drive (optional)
 - ⑦ Telescope lens rain cover / sun shade
 - ⑧ Instrument batteries (space for 3 batteries) (optional)
 - ⑨ USB flash drive (optional)
 - ⑩ Getting started guide (optional); Laser adjustment target; Screen protectors
-

CAUTION – If the instrument is equipped with an optional DIN adapter for DIN tribrach, the DIN tribrach must be removed before the instrument is placed in the instrument case.

¹Not all data collectors are designed to fit this space.

Instrument Versions

There are three different instrument types available: LockNGo™, RX, and Robotic. For more information please read the [Instrument Operational Methods](#). The instrument labels are on the bottom of the instrument.

NOTE - Some specifications in this manual depend on the instrument revision. FOCUS 35 total stations with the following part number prefixes match this manual exactly:

- Robotic part numbers beginning with "7853"
- RX part numbers beginning with "7855"
- LockNGo part numbers beginning with "7847"

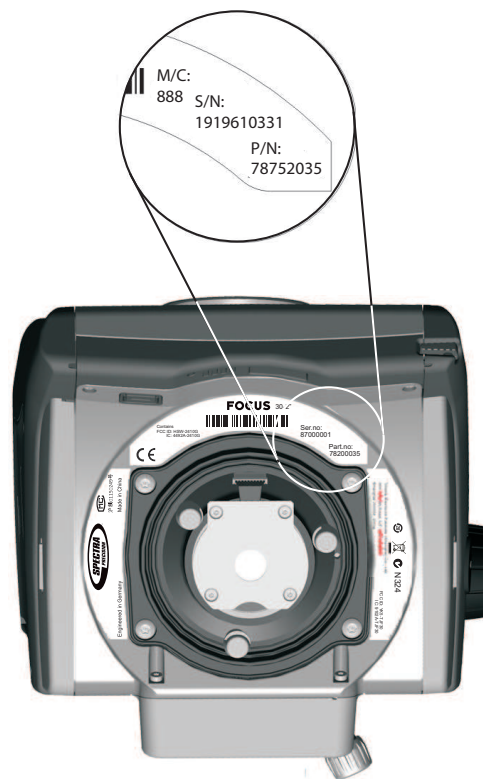

Instrument types

FOCUS 35 Robotic 1"
 FOCUS 35 Robotic 2"
 FOCUS 35 Robotic 3"
 FOCUS 35 Robotic 5"
 FOCUS 35 RX 2"
 FOCUS 35 RX 3"
 FOCUS 35 RX 5"
 FOCUS 35 LockNGo 1"
 FOCUS 35 LockNGo 2"
 FOCUS 35 LockNGo 3"
 FOCUS 35 LockNGo 5"

Care and Maintenance

WARNING - Do not remove the instrument cover from the instrument.

A FOCUS 35 Total Station is designed to withstand normal electromagnetic disturbance from the environment, but it contains circuits that are sensitive to static electricity. If an unauthorized person opens the instrument cover, the function of the instrument is not guaranteed and the warranty is invalidated.

The FOCUS 35 Total Station is designed and tested to withstand field conditions, but like all precision instruments, it requires care and maintenance.

Take the following steps to get the best results from the instrument:

- Do not subject the equipment to rough jolts or careless treatment.
- Keep the lenses and reflectors clean. Use only lens paper or other material that is designed for cleaning optical equipment. A cleaner with a solution of pure water and 20-30% 2-Propanol specified with evaporation residue <5mg/l is recommended.
- Keep the instrument protected and in an upright position, preferably in the instrument case.
- Do not carry the instrument while the instrument is mounted on a tripod. Doing so can damage the tribrach screws.
- Do not carry the instrument by the telescope barrel, please use the handle.
- When you need extremely precise measurements, make sure that the instrument has adapted to the surrounding temperature. Significant variations in instrument temperature can affect precision.

Cleaning

Be very careful when cleaning the instrument, especially when removing sand or dust from lenses and reflectors. Never use a coarse cloth, a dirty cloth, or hard paper to clean the instrument. Spectra Geospatial recommends that you use anti-static lens paper, a cotton wad, or a lens brush.

CAUTION – Never use strong detergents such as benzine or thinners on the instrument or the instrument case.

Care of the Screens

Clean the screens with a dust-free cloth and gently wipe the screen. Use the provided dust-free cloth in the screen protector package.

CAUTION – Do not use abrasive cleaners and do not apply any Cleaning Solution directly on the screen.

Applying a Screen Protector for the Face 1 Screen (if fitted)

Before applying a screen protector please read the screen protector installation guide/information provided inside the screen protector package.

Use the screen protectors (ULTRA-Clear or ANTI-Glare) included in the instrument case to keep the touchscreen clean and protected.

To apply a screen protector:

- Clean the display thoroughly with the provided dust-free cloth.
- Peel the backing from the screen protector.
- Align the edge, and then drop the remainder onto the display.
- Use the provided installation card, if necessary, to squeeze the air from underneath the screen protector.

Ultra-Clear: Screen Protection with 99% visual transparency.

ANTI-Glare: Screen Protection with a perfect blend of anti-glare and optical clarity.

Removing Moisture

If the instrument has been used in damp weather, take the instrument indoors and remove the instrument from the instrument case. Leave the instrument to dry naturally. If condensation forms on the lenses, allow the moisture to evaporate naturally. Leave the carrying case open until all moisture has evaporated.

Transporting the Instrument

Always transport the instrument in a locked instrument case. For longer trips, transport the instrument in the instrument case and inside the original shipping container.

Servicing

NOTE - There are no user-serviceable parts on the FOCUS 35 Total Station.

Spectra Geospatial recommends that you take the instrument to an authorized service center for service and calibration once a year. This is to guarantee that the specified accuracies are maintained.

When you send the instrument to a service center, clearly write the name of the sender and the receiver on the instrument case. If repairs are required, enclose a note in the instrument case. The note should clearly describe any fault or symptoms, and indicate that servicing is required.

Getting Started

- ▶ Power Supply
- ▶ Suspend Mode
- ▶ Instrument Description
- ▶ Optical Plummet
- ▶ Trigger Key
- ▶ Control Unit Face1 (if fitted)
- ▶ Control Unit Face2
- ▶ Telescope Lens rain cover / sun shade
- ▶ Setting Up and Running ActiveSync technology
- ▶ Troubleshooting Windows Mobile Device Center Connection Issues
- ▶ Disconnecting ActiveSync
- ▶ Laser Information

Power Supply

Before charging or using a battery it is important that you read and understand the battery safety and environment information.

Battery Safety and Environment Information

WARNING – Do not damage the rechargeable Lithium-ion battery. A damaged battery can cause an explosion or fire, and can result in personal injury and/or property damage. To prevent injury or damage:

- Do not use or charge the battery if it appears to be damaged. Signs of damage include, but are not limited to, discoloration, warping, and leaking battery fluid.
- Do not expose the battery to fire, high temperature, or direct sunlight.
- Do not immerse the battery in water.
- Do not use or store the battery inside a vehicle during hot weather.
- Do not drop or puncture the battery.
- Do not open the battery or short-circuit its contacts.

WARNING – Avoid contact with the rechargeable lithium-ion battery if it appears to be leaking. Battery fluid is corrosive, and contact with it can result in personal injury and/or property damage. To prevent injury or damage:

- If the battery leaks, avoid contact with the battery fluid.
- If the battery fluid gets into your eyes, immediately rinse your eyes with clean water and seek medical attention. Do not rub your eyes!
- If battery fluid gets onto your skin or clothing, immediately use clean water to wash off the battery fluid.

WARNING – Charge and use the rechargeable Lithium-ion battery only in strict accordance with the instructions. Charging or using the battery in unauthorized equipment can cause an explosion or fire, and can result in personal injury and/or equipment damage. To prevent injury or damage:

- Do not charge or use the battery if it appears to be damaged or leaking.
- Charge the lithium-ion battery only in a Spectra Geospatial product that is specified to charge it. Be sure to follow all instructions that are provided with the battery charger.
- Discontinue charging a battery that gives off extreme heat or a burning odor.
- Use the battery only in Spectra Geospatial equipment that is specified to use it.
- Use the battery only for its intended use and according to the instructions in the product documentation.

Battery Disposal

Before disposal, discharge the battery.

Dispose of the used battery in an environmentally sensitive manner, according to local and national regulations, see also [Environmental Information](#).

Checking the Instrument Battery Power Supply

To check the power supply in the FOCUS 35 Total Station battery using the built-in battery gauge, press the button on the side of the battery:



When you press the button, four LEDs on the battery show the power level. Each LED corresponds to a power level of 25% so that when the power level is at 100%, all four LEDs are lit. If the battery is completely discharged, all LEDs are unlit.

When the button is pushed and all the LEDs flash, the battery needs to be reconditioned in the battery charger.

When the battery capacity is between 0 and 10% one LED is flashing. A battery that has a flashing LED might not be able to start the instrument. If started, with a battery that has a flashing LED, the operating time will be between 5 and 15 minutes.

Charging the Instrument Batteries

The batteries are supplied partially charged. Charge the batteries completely before using it for the first time.

- To charge the batteries, use only the charger that is recommended by Spectra Geospatial for charging the lithium-ion battery. The charger can charge instrument and radio batteries. It can be powered by mains power or from a car battery (socket / cigarette lighter adaptor). The charger can be used either in car or office.
- Before charging the batteries please read the charger instruction information that was provided with the charger package.

- Charge the battery before using the total station if the equipment has been stored for longer than six months.

Via country specific adapter to mains power

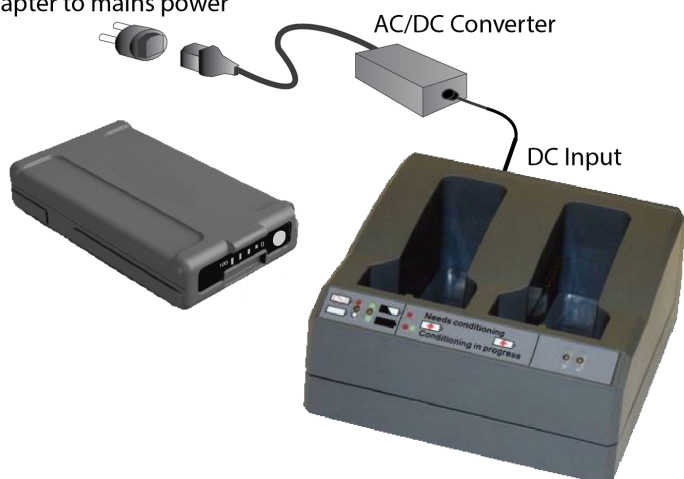

Inserting the Main Battery

The FOCUS 35 Total Station internal battery fits into the battery compartment on the side of the instrument. This battery can easily be removed and replaced.

To insert the battery:

1. Press gently on the battery release button to open the battery compartment door.
2. Slide the battery into the battery compartment with the battery connectors positioned towards the bottom of the instrument.

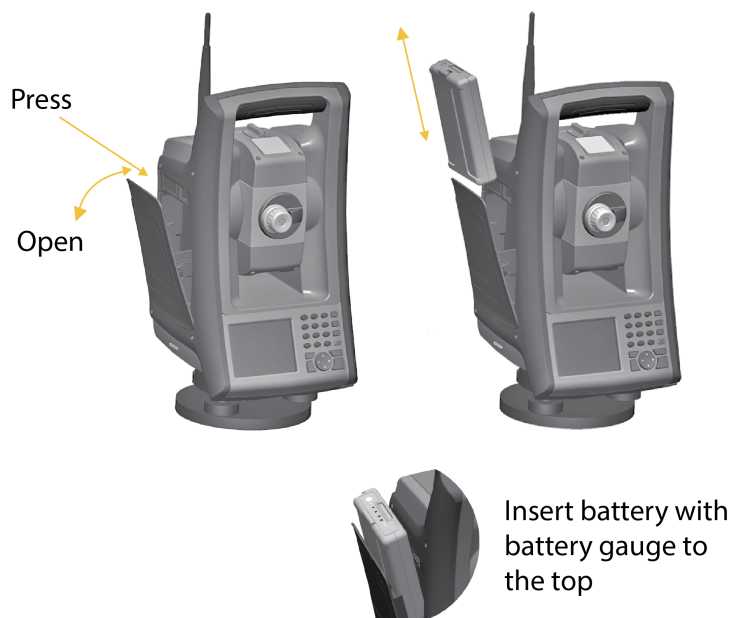

Inserting the Face 1 Battery (if Available)

On some FOCUS 35 Total Station models a second battery fits into the Face 1 battery compartment. This battery can easily be removed and replaced.

To insert the battery:

1. Press gently on the two battery release buttons on either side of the compartment to open the battery compartment door.



2. Slide the battery into the battery compartment door with the battery connectors positioned facing upwards.

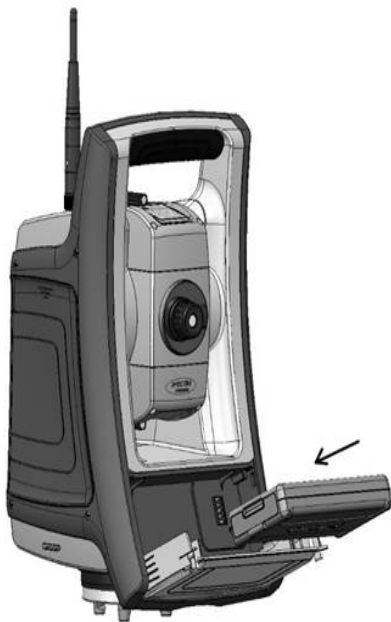

3. Close the battery compartment door, ensuring that both battery release buttons click into place.



Suspend Mode

The FOCUS 35 Total Station is equipped with an internal support module (support capacitor) that enables you to suspend (“hotswap” or replace) the instrument battery within a period of 30 seconds from the time you open the battery door.

To resume, press the power button for about one second, until you hear one single beep.

The internal support module is always charged when the instrument is powered on.

If you leave the FOCUS 35 Total Station idle, it goes into suspend mode after 120 minutes by default.

If the FOCUS 35 Total Station has not been restarted when the suspend period (default 120 minutes) has elapsed, the instrument powers down and has to reboot when started again.

If the internal support module runs low on power the FOCUS 35 Total Station powers down sooner. Fully charged and under normal conditions, the internal support battery should have capacity for about five suspend sequences.

For more information please read [Power Management, page 97](#).

Instrument Description

This section describes the instrument controls. Take some time to familiarize yourself with the names and the locations of the controls.

The following image shows the Operator's view of the FOCUS 35 Total Station.



Item	Description
①	Coarse sight
②	Focusing servo knob
③	Vertical motion servo knob
④	Horizontal motion servo knob
⑤	On/Off and Trigger key
⑥	Stylus for touch screen

Item	Description
7	Face1 Control Unit or optional Face 1 Battery Compartment
8	Eyepiece

The following is the Front view of the FOCUS 35 Total Station.

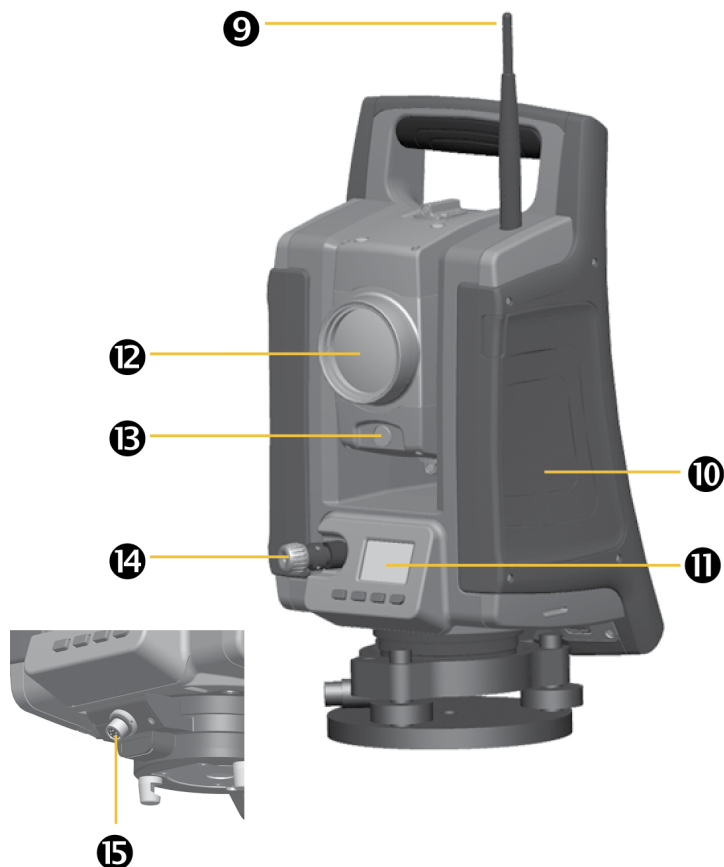

Item	Description
9	Radio antenna Radio antenna is not required in the LockNGo model.
10	Compartment for instrument battery
11	Face2 Control Unit
12	Optical plummet
13	Optics for tracklight
14	Coaxial optics for angle and distance measurements, tracker and laser pointer
15	Connector for both communication (COM) and power (12 V)

The following image shows the Connector Rubber Cap Placement.

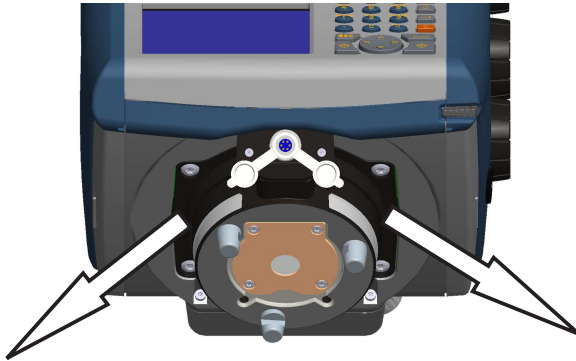

NOTE - Please place the rubber cap in one of the shown directions. Another orientation will limit the function to insert instrument into tribrach or to turn the instrument.

Optical Plummet

The instrument is equipped with an optical plummet, which has 2x magnification and a focusing range of 0.5 m (1.6 ft) to infinity. The instrument can be positioned to an accuracy of 0.5 mm (0.02 in) at 1.5 m (49 ft) over a ground mark.



- To focus the crosshair, rotate the eye-piece.
- To focus the optical plummet to the ground, push in or pull out the optical plummet.

For information on how to adjust the optical plummet, see [Optical Plummet, page 77](#).

Trigger Key

The trigger key functions as an On/Off key (👁️). A LED in the trigger key indicates if the instrument is turned on. A solid light indicates On and a flashing light indicates Suspend Mode and waiting for connection, see also [Power Management](#).

When a field application is running, the trigger key performs the same function as the Measurement1 key (📏) on the Face1 side and the Enter key (↵) at the Face2 side.

Keys	Description
📏 👁️ ↵	Measurement1 - definable
📏	Measurement2 - reflectorless measurement and recording (Except the measurements in QuickShot menu without open job)

Control Unit Face1 (if fitted)

Data entry on the keyboard is similar to that of a mobile phone. The "A" button scrolls between three different states of data entry: 123, ABC, and abc. Multiple presses on one key scrolls through the letters on that key depending on which mode is currently selected.

















The image shows the Control Unit Face1.



Item	Description
1	Quick Shot Menu
2	Measurement 1
3	Measurement 2

Control Functions Control Unit Face1

In addition to data entry and the standard Microsoft® Windows® operating system functions, the Control Unit has a number of control functions that are Spectra Geospatial specific. These functions are described in the table below.

Keys	Function	Description
		Measurement1 (in field software only)
		Measurement2 (in field software only)
		Quick Shot Menu (in field software only)
 +  C		Toggle the backlight on/off
 +  K		Disable/enable the touch screen
 + S		Toggle the touch screen keyboard on/off
 +  I		Switch to level bubble - in field software only
 +  Z		Pop up the Windows taskbar
 +  +		Enter a "-" or a "+" symbol
 +  Y		Delete

Operating System

The FOCUS 35 Total Station runs the Windows CE .Net operating system.

Data Storage

The FOCUS 35 Total Station has two kinds of memory:

- 512 MB RAM
 - RAM is volatile, and you risk losing data if the power fails.
- 4 GB NAND flash storage memory

The NAND flash storage memory is non-volatile, and protects valuable data and software against memory loss.

Entering Information

Tap once on the **Input Panel** icon that is located in the Windows CE Taskbar. The icon is selection related.



Input Panel menu

The Input options are **Keyboard** or **Survey Keyboard**:



Keyboard – allows you to input data as if you were typing on a physical keyboard



Survey Keyboard – has larger keys than the keyboard



Touch Screen

The LCD screen in Face1 can be viewed easily both in direct sunlight and in overcast conditions. It also incorporates a touch interface for navigation. Tap elements on the screen with a stylus or your finger.

Calibrating the Touch Screen





If the touch screen does not respond properly when you tap it, recalibrate it as follows:

Tap the **Start** menu and select **Settings / Control Panel / Stylus**. The **Stylus Properties** appears.



To recalibrate, tap **Recalibrate** in the **Calibration** tab.

Follow the prompts on the screen.

Disabling the Touch Screen

To clean the touch screen during a survey, press  +  [] to disable it. To enable the touch screen again, press  + .

Display Backlight Face1 Control Unit

The display light is active by default and can be toggled on/off by pressing  +  []. To change backlight brightness and save battery life

Tap the **Start** menu and then select **Settings / Control Panel / Display Properties / Backlight**.

Adjust Backlight brightness and select when the instrument has to turn off the backlight automatically.

Tap **OK**.

NOTE – Settings for display light Face2 and reticle illumination see [Settings Face2 Display Backlight, Reticle Illumination and Tracklight](#).

Settings Time and Date

Tap **Start** menu and then select **Settings / Control Panel / Date / Time**.





Change the date and time as required.



To accept the new settings, tap **OK**. To cancel, tap .

NOTE – When you attach the instrument to your computer using Microsoft® ActiveSync® technology, the time and date are automatically updated.



Control Unit Face2

The Face2 control unit is a graphical display with a built-in backlight and four control buttons.

Function	Description
	Change Face
	Scroll Up
	Scroll Down
	Enter

When a secondary function is available for the keys (,  or ) , an icon appears at the bottom of the display. To access the secondary function, press the appropriate key.

A long press with the key  starts the **Control Unit Face2 Backlight**. Without any actions **Backlight** turns off after 30 seconds.

NOTE - When the field software is running, the trigger key performs the same function as the Measurement1 key () on the Face1 side and the Enter key () at the Face2 side.

Telescope Lens rain cover / sun shade

The Telescope Lens rain cover / sun shade protects the objective lens surface while measuring in drizzle or lighter rain. The cover works in one Face only. The rubber material prevents damage to the internal instrument system itself while unintentional moving between the two faces.

Fit the objective rain cover to the Face1 side of the instrument with the shield at the top of the objective.

CAUTION - Dust and rain can have an effect on the distance measurements, please keep objective front lens and the targeting prism clean and use the objective rain cover.



Connecting the Instrument to an Office Computer

Transferring Data Files

Microsoft ActiveSync technology and Windows Mobile® Device Center (WMDC) provide an easy way to synchronize data on a Windows-based computer with your FOCUS 35 Total Station. WMDC works only on computers that have the Windows Vista® or Windows 7 operating system. Windows 10 version 1703 and later have been found to have issues running Windows Mobile Device Center (WMDC). For more information, please see [Troubleshooting Windows Mobile Device Center Connection Issues](#).

ActiveSync and WMDC act as gateways between your device and your computer for transferring data. You can also use the Explore feature in either program to move files or programs from your computer to your device.

ActiveSync is already integrated into the operating system on the FOCUS 35 Total Station. However, you must install ActiveSync or WMDC depending on your computers operating system. To download the current version:

- ActiveSync technology: www.microsoft.com/en-us/download/details.aspx?id=15
- Windows Mobile Device Center: www.microsoft.com/en-us/download/details.aspx?id=14

There are two types of ActiveSync connections. The table below summarizes the advantages and disadvantages of each choice.

	Advantages	Disadvantages
Guest	<p>Fewer questions to answer on initial connection.</p> <p>Safer because synchronization cannot adversely impact data either on the instrument or the computer.</p>	<p>Slower subsequent connections (one more step per connection that requests Partnership).</p> <p>You have to arrange these settings with every new instrument connection.</p>
Partnership	<p>Fast subsequent connections (one fewer step per connection).</p> <p>The clock on the instrument is set to match the computer clock.</p>	<p>More questions to answer on initial connection.</p> <p>If the clock on the computer is wrong, it will incorrectly set the clock on the instrument.</p> <p>Partnership is deleted when the instrument is hard reset.</p>

Setting Up and Running ActiveSync technology

Please use the Hirose-USB cable to connect the FOCUS 35 Total Station with a USB port of your computer. The instrument will switch on automatically.

NOTE – Microsoft ActiveSync technology or the Windows Mobile Device Center will start automatically, depending on the operating system that is installed on your computer.

Do the following:

1. Program ActiveSync starts automatically.



2. If you select **Connect without setting up your device**, you are set up as a guest and the dialog does not appear asking which items to synchronize. Go to [Enter the device name and click Set Up](#). The Home screen appears:.

3. If you select **Set up your device**, Spectra Geospatial recommends that you clear all the check boxes in the next dialog.

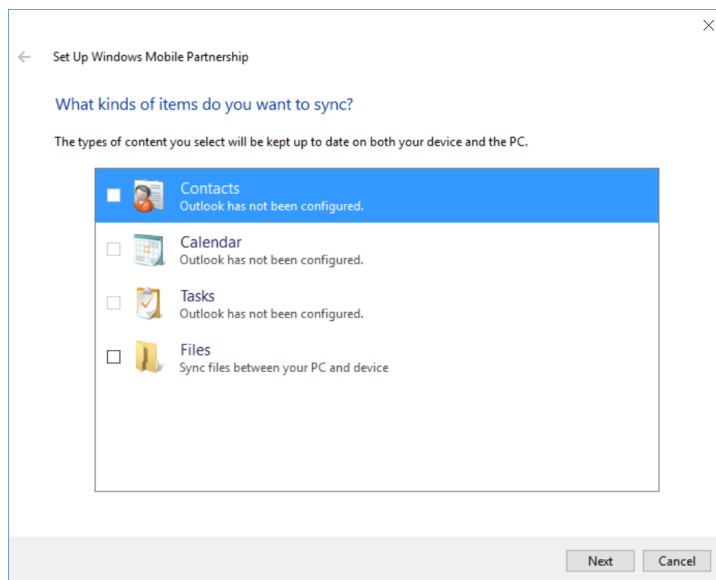

4. Click **Next** to continue.

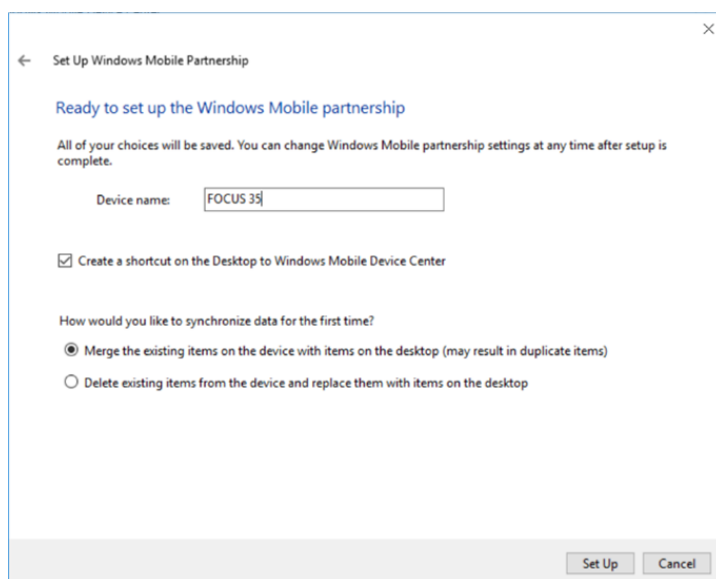

5. Enter the device name and click **Set Up**. The **Home** screen appears:



6. To view the files on the Instrument, click the **File Management** icon, then click **Browse** the contents of your device. The file structure looks and functions the same as Windows Explorer on your computer:

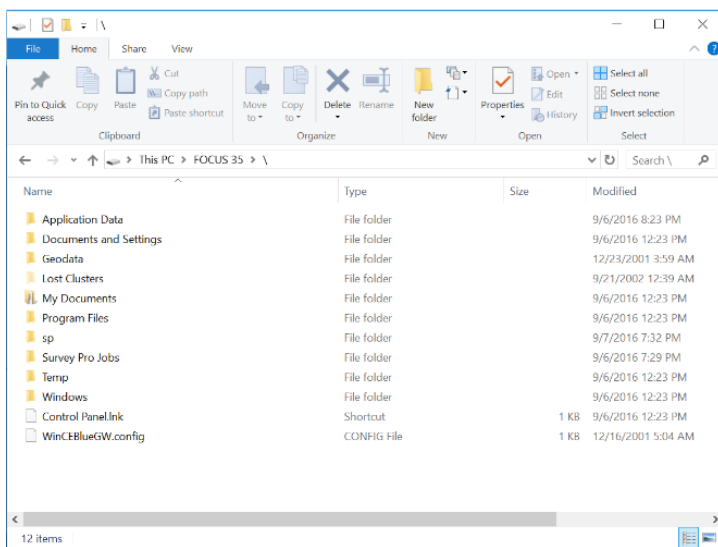

Troubleshooting Windows Mobile Device Center Connection Issues

Microsoft ended support for the Windows Mobile® Device Center (WMDC) in 2012; the latest Microsoft PC operating systems are not designed to be compatible with WMDC. WMDC may not work with Windows® 10 version 1703, or any subsequent Windows 10 versions. The following options may help WMDC start working again:

Install and enable .NET Framework 3.5

Sometimes before successfully installing WMDC, you must enable the required .NET Framework 3.5. This can be done from inside the control panel, or by running a previous framework installer from Microsoft.

Option 1: Enable .NET Framework 3.5 within the control panel:

1. Navigate to **Control Panel / Programs / Programs and Features / Turn Windows features on or off**.
2. Select the **.NET Framework 3.5** check box.

Option 2: Enable .NET Framework 3.5 by running a previous framework installer from Microsoft:

1. Download the Microsoft Windows Mobile Device Center 6.1 Driver for Windows Vista directly from www.microsoft.com, selecting either the 32- or 64-bit version that is appropriate for your computer.
2. If WMDC and the required drivers do not successfully install automatically through the Windows Update service when you connect to USB, run the installer as an administrator and in Compatibility Mode for Windows Vista.

Registry Changes

After installation and once the Windows Mobile Device Center appears in the product list under the **Start** menu on the desktop PC, you may need to add the following registry entries, and then perform a restart of the computer:

- HKLM\SYSTEM\CurrentControlSet\Services\RapiMgr\SvcHostSplitDisable = 1
- HKLM\SYSTEM\CurrentControlSet\Services\WcesComm\SvcHostSplitDisable = 1

These registry entries change the way the operating system handles the background processes (*services*) that control WMDC connectivity. The handling of background services changed in Windows 10 version 1703 and these additions allow WMDC to continue to work.

A PC application tool that will add these registry settings is available to simplify the registry editing process.

1. Download the Registry Editing Tool from Trimble:
<http://trl.trimble.com/dscgi/ds.py/Get/File-848877/WMDCRegistryUpdate.exe>

2. From the File Explorer, right-click the file and choose **Run as Administrator**.

The tool must be run with Administrator privileges because it modifies the computer's registry.

3. A pop-up confirms the tool is from Trimble and asks for confirmation to run; choose **Yes**.
4. A command window opens and displays the changed registry values. Press any key to exit the application once it is complete.

Disconnecting ActiveSync

CAUTION – To avoid disconnection problems, close ActiveSync before removing the cable. Next remove the cable from the computer and then the cable from the instrument.

To disconnect ActiveSync:

1. Double-tap the connection icon in the task bar at the bottom of the screen, see image below for location of icon.

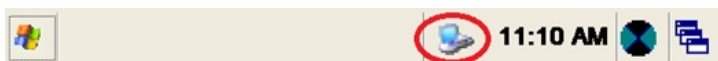

TIP – You have to wait a few seconds until the next screen appears.

2. Tap **Disconnect** and then remove the cable:



For more information about ActiveSync, refer to the help or visit the Microsoft website.

Laser Information

For more information, see Laser Safety, [page 4](#).

FOCUS 35 Total Station

The FOCUS 35 distance measuring unit and Laser Pointer has been tested and complies with the regulations for a CLASS 3R LASER PRODUCT.



Item	Description
1	Distance measurement LockNGo and Laser pointer aperture
2	Tracklight aperture

Location of Laser warning label on a FOCUS 35 Total Station

The laser warning label is located on the top of the distance measuring unit.



Distance Measurement Unit and Laser Pointer warning label:

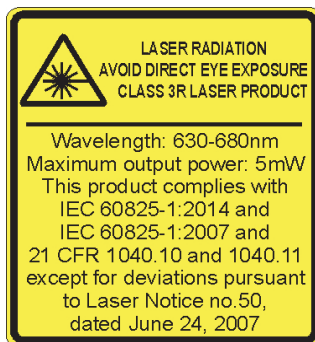

Location of Laser aperture label on a FOCUS 35 Total Station

The laser aperture label is located on one side of the telescope close to the objective.



Laser aperture label:



4

Setup

- ▶ Setup
- ▶ Starting the Instrument
- ▶ Security
- ▶ Face2 Display while using the Survey Pro Software in different Instrument Versions
- ▶ Instrument Adjustment and Calibration
- ▶ LockNGo Tracker
- ▶ Measuring the Instrument Height
- ▶ Pre Measurement Check List
- ▶ Connecting to an External Data Collector

Setup

An instrument setup with good measuring stability will increase the precision in the measurement result and allow you to utilize the measurement precision of the FOCUS 35 Total Station to its full extent.

Setup Stability

When an instrument is setup it is important to consider the following:

1. Set tripod legs wide apart to increase the stability of the setup. A setup where one leg is placed on, for example, asphalt and the other two on soil will still be a stable setup provided that the tripod legs are set wide enough apart. If it is not possible to set the tripod legs wide apart due to obstacles, then the tripod can be lowered to increase stability.

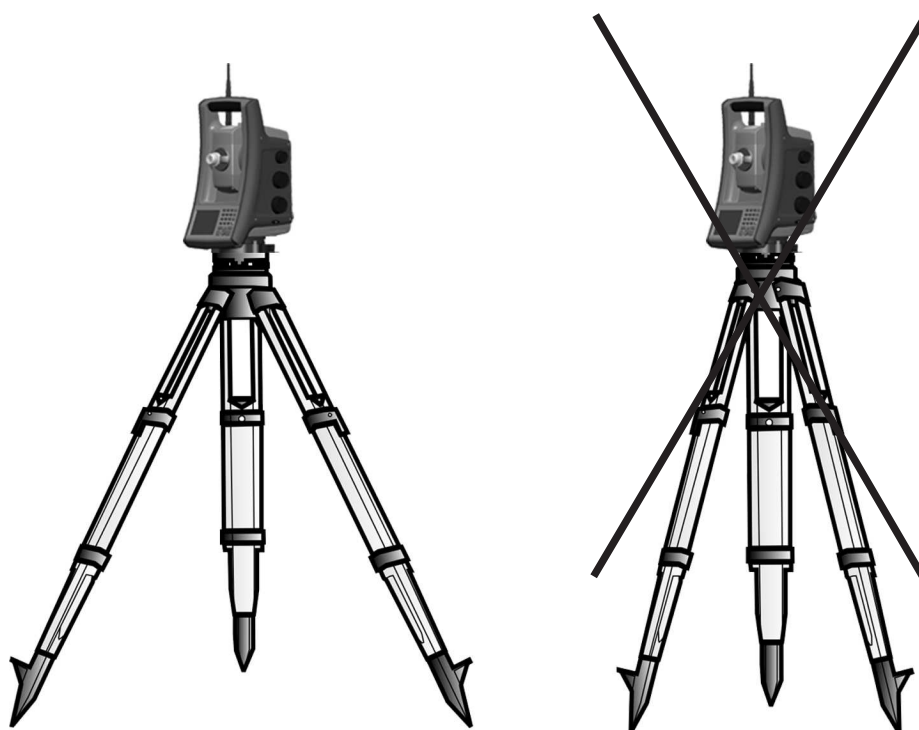

2. Make sure that all the screws on the tripod and/or tribrach are tightened to avoid any play.
3. Any high quality tripod and tribrach can be used. However, Spectra Geospatial strongly recommends the use of tripod heads made of steel, aluminum or similar material. Tripod heads of fiberglass or other composite materials are not recommended.

See also [StepDrive Motor System and Focus System](#), page 94 for more information.

Measurement Stability

Take into account that instruments require sufficient time to adjust to the ambient temperature. The following rule-of-thumb for a high precision measurement applies: Temperature difference in degree Celsius ($^{\circ}\text{C}$) $\times 2$ = duration in minutes required for the instrument to adjust to the new temperature.

Avoid sighting across fields with intense heat shimmer by sun light, e.g., at noon.

Starting the Instrument



To start the instrument please press the on/off button about 1 second (one single beep) on right side of the instrument. This will also start the Windows CE operating system.

This section describes sequentially how different settings can be done in the field software in Face1 Control Unit as well as in the Face2 Control Unit.

- The settings in the Face2 interface are accessible only without starting the field software. It is recommended especially if you want to work in Robotic mode.
- When the Windows CE operating system starts, select your field software from the start menu. Please refer to your Survey field application documentation for supplementary information.

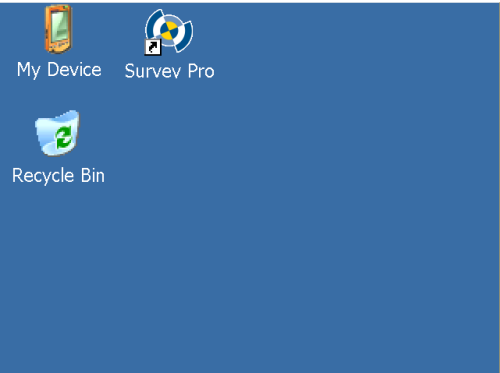

Starting and Settings via Face1 Control Unit (if fitted)

Screen	Actions and Comments
<p>Face1 screen after instrument start</p>  <p>The image shows the Spectra Geospatial logo, a large yellow stylized 'S' on a dark blue background with a light blue glow. Below the logo, it says 'SPECTRA GEOSPATIAL' and '© 2019 SPECTRA GEOSPATIAL. ALL RIGHTS RESERVED.'</p>	<p>While starting Windows CE the Spectra Geospatial logo screen will show for several seconds and then the menu to work in Windows CE will appear.</p>
<p>Face1 screen after starting Windows CE</p>  <p>The image shows a Windows CE desktop with a blue background. There are three icons: 'My Device' (a phone icon), 'Survey Pro' (a surveying instrument icon), and 'Recycle Bin' (a trash can icon).</p>	<p>Start the Survey Pro™ software by tapping the Survey Pro icon.</p> <p>NOTE – StepDrive motor system and Focus System are already usable at this phase.</p> <p>NOTE – If you are using the Layout Pro™ software, refer to the User Guide for information on using the FOCUS 35 total station.</p>
<p>Face1 screen while starting the Survey Pro software</p>  <p>The image shows the Survey Pro loading screen. It features the text 'SURVEY PRO' in yellow at the top left. In the center is a large graphic of a surveying instrument's bubble level, with a yellow and blue circular design. At the bottom left, it says 'SPECTRA GEOSPATIAL'.</p>	<p>Instrument loads the Survey Pro software.</p>
<p>Electronic bubble for leveling process</p>	<p>After starting the Survey Pro software, the screen shows the Level menu. Level the instrument with the help of the electronic bubble.</p>

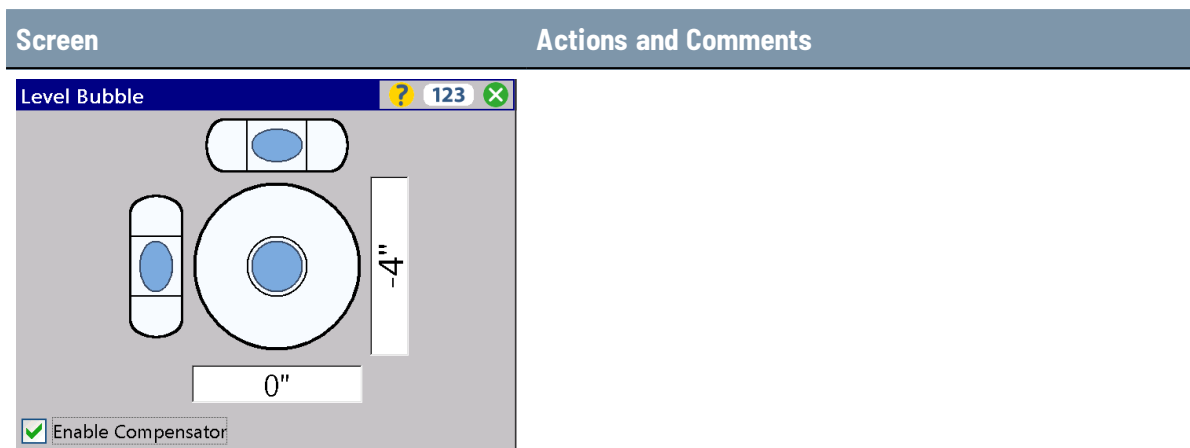

First Steps in the Survey Pro software

Spectra GeoSpatial recommends spending some time reading the *Survey Pro User Guide* to learn details of the application program.



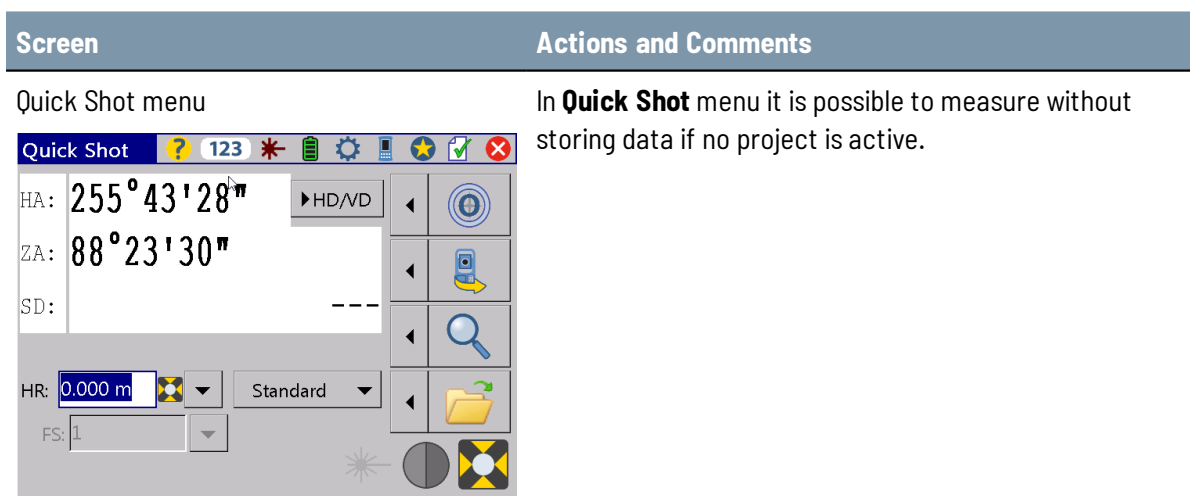

This section describes a brief overview.

Quick Shot Menu

After confirming the **Level Bubble** menu the screen shows the **Quick Shot** menu.



Quick Shot menu with distance values

Start the measurement either with ,  (F1),  (F2) or .

Screen	Actions and Comments

NOTE - Survey Pro cannot start without a job being open, so you have to open or create a new job (file). In case you close the **Quick Shot** menu before you open or create a new job, Survey Pro will be closed.



NOTE - If the laser pointer is in use it can be switched OFF in two different ways: 1. Switch OFF the laser pointer and the instrument will still stay in reflectorless mode. 2. Change from reflectorless mode into prism mode and the instrument will stay in prism mode.

Lookup and register the Survey Pro Software

Screen	Actions and Comments
<p>Registration Modules menu</p>	<p>After the initial start of the Survey Pro software, the following menu will appear. Please select Register Modules and enter your registration code(s).</p>
<p>How to enter codes</p>	<p>Please use the keyboard on the screen to enter registration code.</p>

Screen **Actions and Comments**

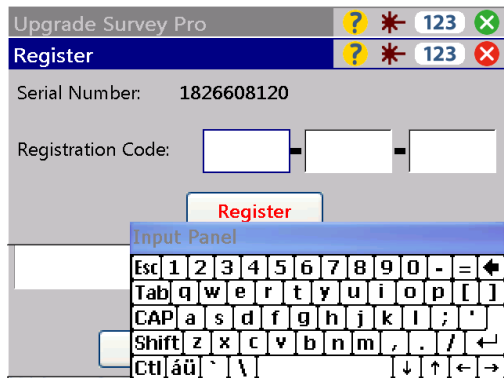

Finalizing registration codes

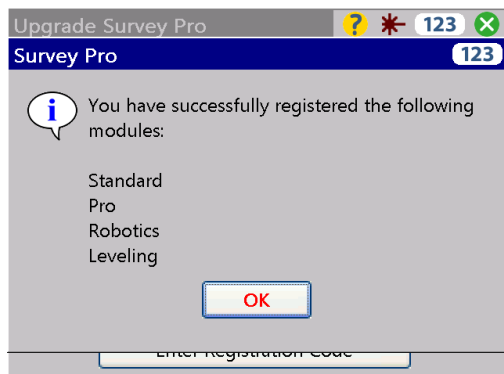

NOTE - If you select **Run In Demo Mode**, all areas of the software are available, with the limitation a job cannot exceed 25 points.

Open or create a Job

Screen **Actions and Comments**

Survey Pro Main Menu

Select the **File** menu.

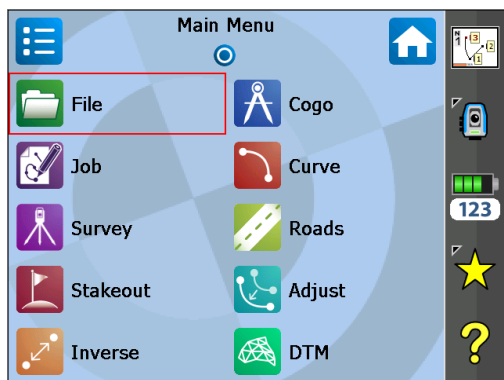

Screen	Actions and Comments
--------	----------------------

Menu to work with jobs

Select a file with **Open** or create a New Job with **New**.

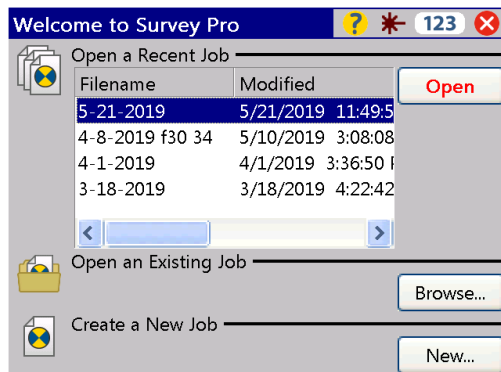

Survey Pro Version Number

Screen	Actions and Comments
--------	----------------------

Main Menu File About

Select menu **File** and menu element **About** and the software version appears on the screen.

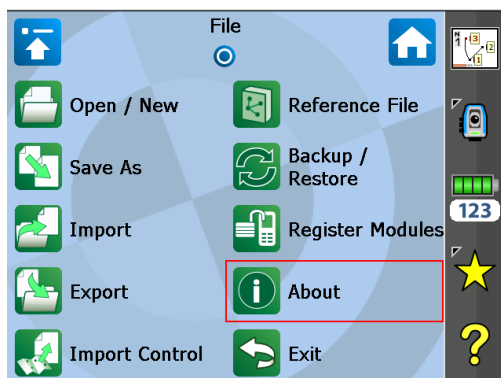

Survey Pro Version

Press the **ESC** button and the program will return automatically to the Main Menu.

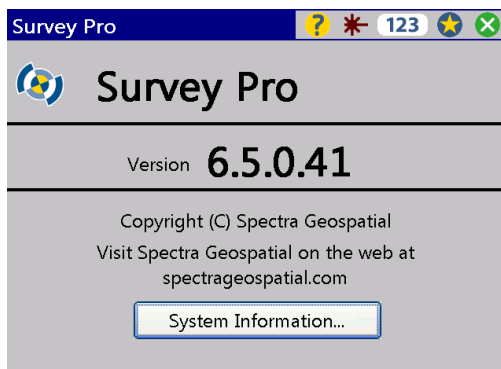

Settings Face2 Display Backlight, Reticle Illumination and Tracklight

Screen	Actions and Comments
--------	----------------------

Main Menu Survey Pro

Select instrument **Settings** by tapping on this icon.

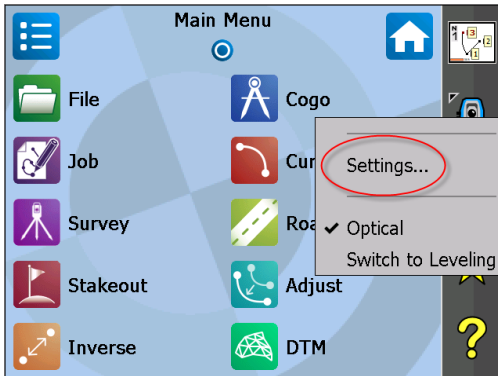

Menu for Settings

Navigate to **Lights** via drop down menu or toggle through the submenus with  key left or right.

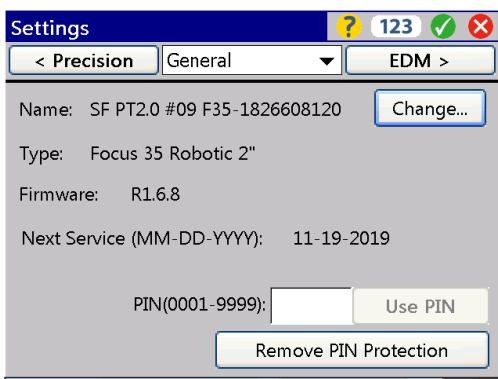

Menu for Lights Settings



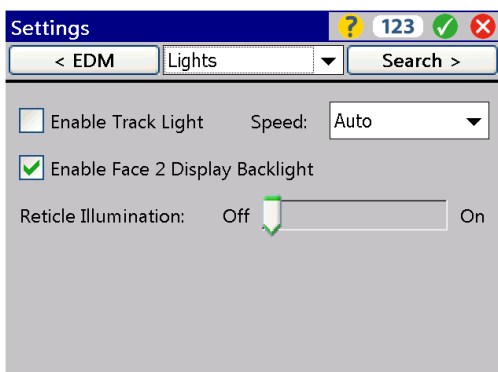





Make selections and confirm the settings.

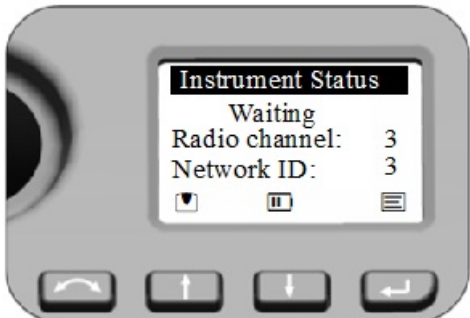

Starting and Settings via Face2 Control Unit





Start Screen

Before following any of the instructions below, put the instrument in the Face2 position. Start the instrument by pressing the trigger key for one single beep.

Screen	Actions and Comments
<p>Start screen Face2 Control Unit</p> 	<p>After starting the screen will display the Spectra Geospatial logo and the firmware version. The instrument checks for an available connection on the set Radio Channel and Network ID for several seconds and then goes to Waiting state.</p>
<p>Instrument Status Menu - Waiting</p> 	<p>First function - Key description</p> <ul style="list-style-type: none">  - Change Face  - Scroll up  - Scroll down  - Enter <p>Second function - on screen symbols - short key press, e.g.</p> <ul style="list-style-type: none">  - Leveling menu  - Status for battery and external power supply status  - Instrument Settings

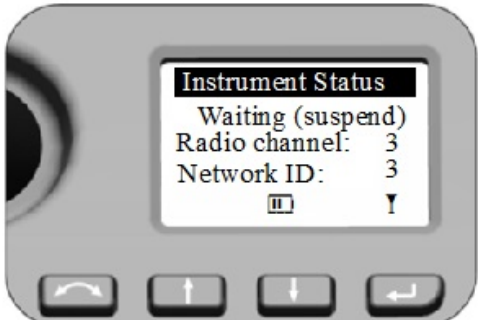







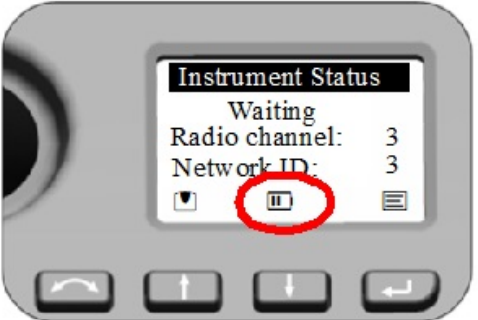

NOTE - StepDrive motor system and FOCUS System are usable while the **Instrument Status** menu shows Waiting.

Screen	Actions and Comments
<p>Instrument Status Menu - Suspend</p>	<p>After Starting: If the instrument is inactive for longer than 5 minutes it will go into Suspend Mode, see also Suspend Mode and Power Management. The display will show Waiting (suspend).</p>

Screen	Actions and Comments
	<p>The instrument will leave the Suspend Mode by starting the field software at the instrument, a short  key press or a  key press (single beep).</p> <p> - Indicates Suspend Mode</p>

NOTE - In Suspend Mode - menu shows Waiting (suspend) - instrument and telescope can be turned by hand, whereas StepDrive motor system and Focus System are not usable.

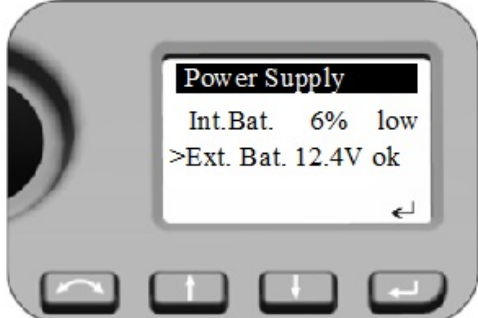
Status Power supply

Screen	Actions and Comments
<p>Instrument Status Menu - Waiting</p> 	<p>Symbol for battery () or external power () supply.</p> <p>Battery symbol with bars or x indicates battery capacity:</p> <ul style="list-style-type: none">  - 75 to 100%  - 50 to 75%  - 25 to 50%  - less than 25% (below 10% ok will be changed to low)  - no function possible <p>For more details and information about external power supply select with a short  key press in the Power Supply Menu.</p>
<p>Power Supply - external source</p> 	<p>Menu shows the voltage of the source.</p> <p>Leave the menu with  press.</p>

Leveling

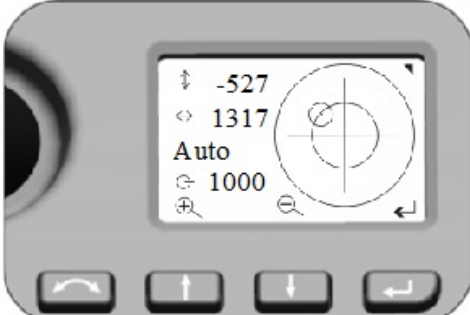
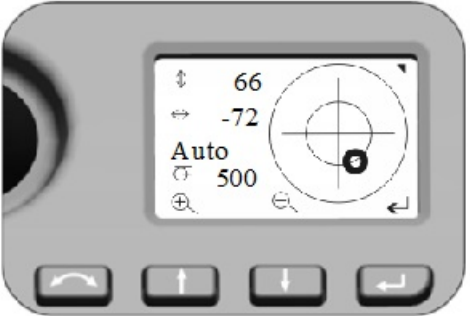
Screen	Actions and Comments
<p>Leveling Menu</p> 	<p>Once you have selected the Level menu, the electronic bubble appears in Face2 display.</p> <p>NOTE - Values always in 0.1 mgon; (0.3 mgon = 1"; 0.1 mgon = 1 cc)</p> <ul style="list-style-type: none"> ↕ Telescope direction ↔ Trunnion Axis direction 🔍 Bubble Scale value (Auto - max. 35 000; min. 500) ⊙ Instrument inclination > 100 mgon ⦿ Instrument inclination < 100 mgon
<p>Leveling Menu bubble adjustment</p> 	<p>Second key functions</p> <ul style="list-style-type: none"> 🔍 Scale expansion (Manual mode - min. 100) 🔍 Scale reduction (Manual) ⬅️ Back to Instrument Status menu

NOTE - If there is field software at Control Unit Face1 started, this field software controls the Face2 display. While using the field software in every menu the Main Menu from the Face2 display can be opened with a long  key press!

Security

To avoid unauthorized use of the instrument, you can activate a PIN / PUK security code.



PIN code



The PIN code is a four-digit code where each digit can be set to a number between 0–9, for example, **1234**. If an incorrect PIN code is entered more than ten times, the instrument is locked and the PUK code must be entered, see [PUK code, page 58](#).

By default, the PIN code is set to **0000**. With this code set, security is not activated and the user is not prompted to enter the PIN code at start up.

The user can activate or change the PIN code (see following topic).

Activating or changing the PIN code

On the Face 2 display, press  or  to scroll up or down until you see **Set PIN** and then press .

Press  or  to enter the PIN of your choice digit by digit—press **P** to accept each digit.



After all digits have been set, press  to record the pin.

The menu returns to **Set PIN**.

Using the PIN code to unlock the instrument

When the PIN code has been activated, you must enter it when you start up the Instrument. To do this:

Switch on the FOCUS 35 instrument. The Face 2 display shows the menu **Enter PIN**.

Press  or  to enter the PIN of your choice digit by digit—press  to accept each digit.

Once all valid digits have been entered, press . This unlocks the instrument—the Face 2 display now shows the menu **Instrument Status**, the Radio Channel, and the Network ID.

If an incorrect PIN code is entered more than ten times, the instrument is locked and the PUK code must be entered, see [PUK code](#). When the correct PUK code is entered, the PIN code is reset to **0000** and the security PIN code is deactivated.

PUK code

The PUK (Personal Unlock Key) code is factory set on each instrument and cannot be changed by the user.

If the PUK code has been lost, contact your authorized Spectra Geospatial distributor to retrieve it.

If an incorrect PIN code is entered more than ten times, the **Error** menu appears on the Face 2 display with the error message **Invalid PIN** and **Instrument Locked** and shows the softkeys **PIN** and **PUK**.

Press **PUK**. The **Enter PUK** menu appears on the F2 display and shows **PUK: 000000000000**.

Press \uparrow or \downarrow to enter the PUK code digit by digit—press \rightarrow to accept each digit.

Once all valid digits have been entered, press **P**. The FOCUS 35 instrument is unlocked, the PIN code is reset to **0000** and the security PIN code is deactivated.

If an incorrect PUK code is entered (any number of times), **Error** menu appears on the Face 2 display with the softkeys **Cancel** and **Retry**. Select **Retry** to enter the PUK code again or select **Cancel** to abort the procedure.

Face2 Display while using the Survey Pro Software in different Instrument Versions

StepDrive and LockNGo versions

If the field software at Control Unit Face1 is started, the field software controls the Face2 display.

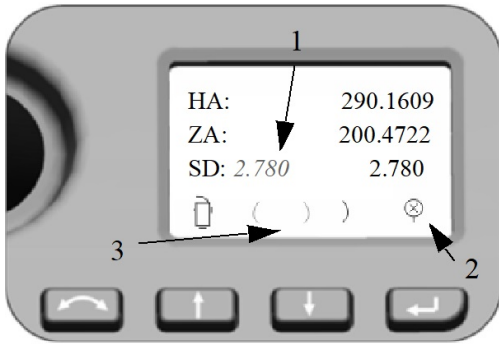





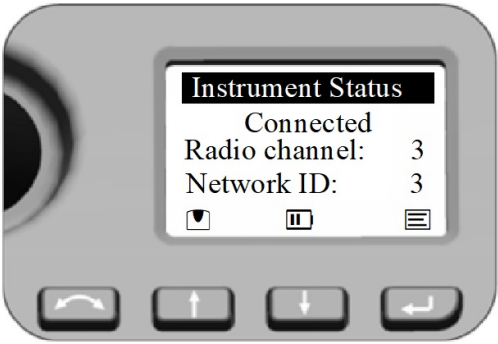

Screen	Actions and Comments
<p>F2 Display while program Survey Pro</p> 	<p>The Face2 display always shows measurement results parallel to the Face1 Control Unit.</p> <ol style="list-style-type: none"> SD value from the last measurement jumps to left. Symbol Prism or Reflectorless target Symbol moves and shows the measurement progress. Different symbols for status LockNGo. <p>NOTE - While using the field software in every menu the Main Menu from the Face2 display can be opened with a long \rightarrow key press!</p>

Robotic and RX versions

If you are using an external controller (independent with radio or cable) with field software that has been started, the controller with field software controls Face2 display.

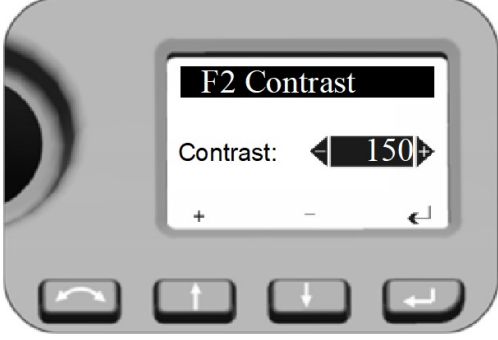
Screen	Actions and Comments
<p>F2 Display while Robotic mode</p> 	<p>The Face2 Display in this configuration shows no measurement results.</p> <p>NOTE - While using the field software at the external Control Unit the Level Menu or Main Menu from the Face2 display can be opened.</p>





Brightness and Contrast

Screen	Actions and Comments
<p>Brightness Menu</p> 	<p>Select with a long press of  key the setting menu for Brightness.</p> <p>Adjust the Brightness by pressing  or .</p> <p>Confirm the selection with .</p> <p>Brightness range: 0 - 20</p>
<p>Contrast Menu</p> 	<p>Select with a long press of  key the setting menu for Contrast.</p> <p>Adjust the contrast by pressing  or .</p> <p>Confirm the selection with .</p> <p>Contrast range: 0 - 256</p>

NOTE - Setting function for brightness and contrast is available on every **F2** menu.

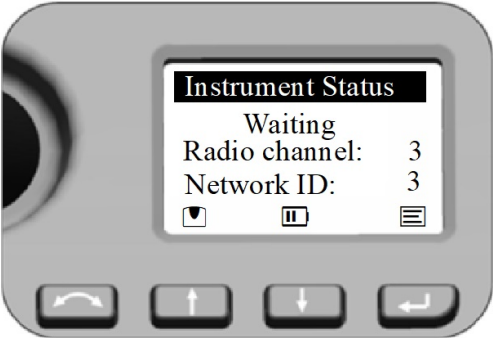
Main Menu Face2 - Information and Settings

With the Face2 display, you can access a number of functions and routines without starting the field software at Control Unit Face1.

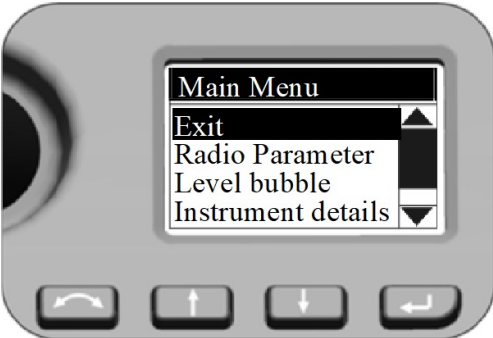
Screen	Actions and Comments
Instrument Status Menu	Select Main Menu by pressing  .
	
Main Menu	Navigate with the  or  key in the Main Menu to highlight the item you want to select. Confirm a selection by pressing the  key.
	

The **Main Menu** is structured as follows:

Content	See ...
Exit	
Radio Parameter	page 61
Level bubble	page 61
Instrument details	page 61
Service menu	page 62

Radio Parameter

In the **Radio Parameter** menu it is possible to set the radio channel and network ID number.

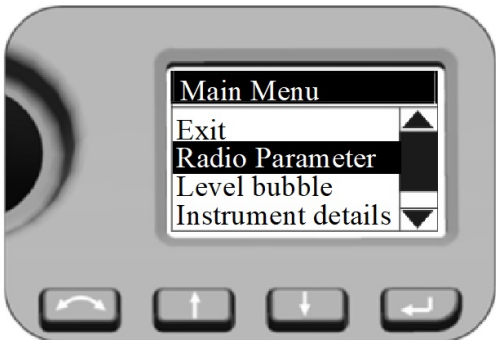
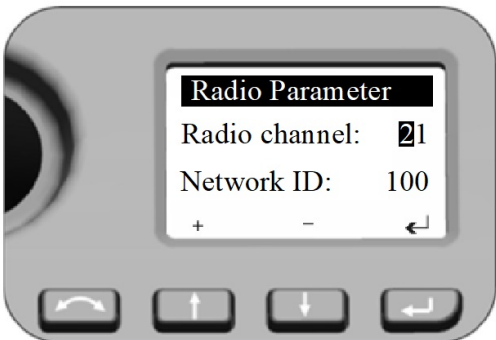
Screen	Actions and Comments
<p>Main Menu</p> 	<p>To set Radio Channel and Network ID, press \uparrow and \downarrow to scroll to Radio Parameter and press \rightarrow.</p>
<p>Radio Parameter</p> 	<p>When entering this menu the cursor jumps to the first digit of the Radio channel, first digit is active (inverse) and with \uparrow or \downarrow the numbers 0-9 can be selected. Press \rightarrow when number is correct - cursor jumps to the next digit.</p> <p>After you have selected the last digit for the Radio channel the cursor jumps to the settings for Network ID with the same procedure.</p> <p>When last digit of Network ID is confirmed, the system jumps back to the Main Menu.</p> <p>Radio channel range: 1 - 30 Network ID range: 0 - 255</p>

Level Bubble

These details are already described in [Leveling, page 56](#).

Instrument Details

The **Instrument Details** menu displays the **Instrument Version**, **Instrument name** (your definition), **Serial number** and **Firmware version**.

Screen	Actions and Comments
<p>Main Menu</p>	<p>To read Instrument Details, press \uparrow or \downarrow to scroll to Instrument Details and press \rightarrow.</p>

Screen

Actions and Comments

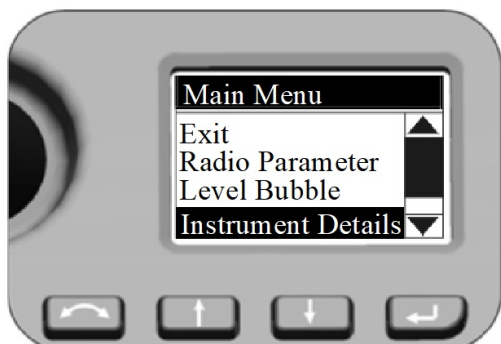

Instrument Details

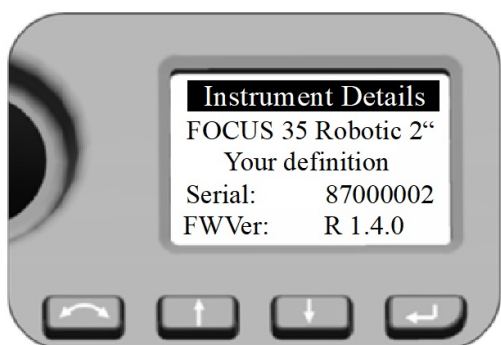
Leave the menu by pressing the  key.

Service menu

The **Service Menu** is structured as follows









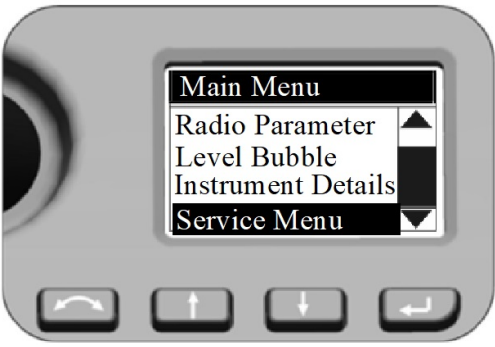
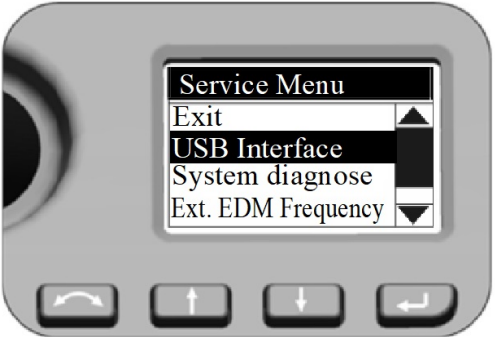
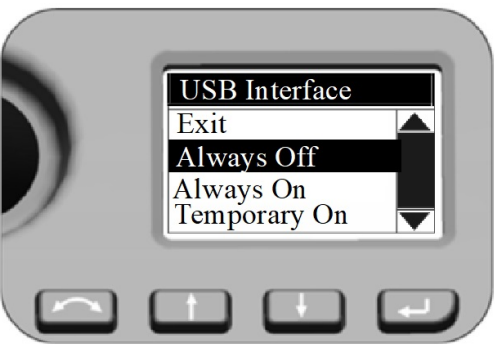

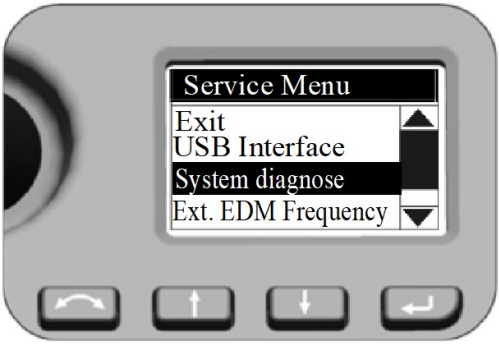
Setting	See ...
Exit	
USB Interface setting	page 63
System diagnose	page 63
External EDM Frequency	page 64
External EDM calibration settings	page 65
Drive Mode	page 66
Radio configuration	page 67
Next Service Date	page 67

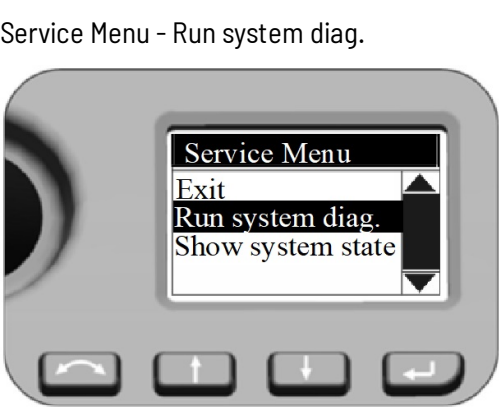
NOTE - The Service Menu is hidden—please contact your Spectra Geospatial Reseller for instructions on how to access this option.

The **Service Menu** enables the following:

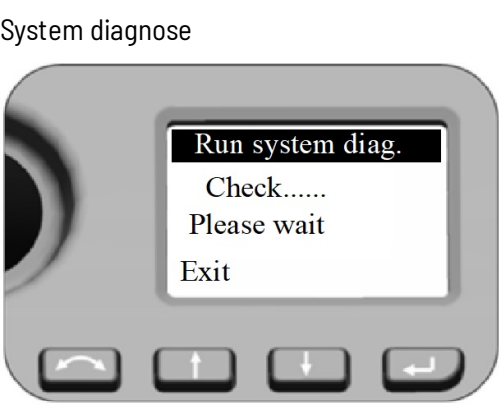
- USB interface settings
- Display and input of External EDM Calibration (scale and offset) for supplementary correction of distance measuring units.
- Radio configuration (France only).

Screen	Actions and Comments
<p>Main Menu - Service Menu</p> 	<p>To select Service Menu, press \uparrow or \downarrow to scroll to Service Menu and press \rightarrow.</p>
<p>Service Menu - USB Interface Settings</p> 	<p>To select USB Interface, press \uparrow and \downarrow to scroll to USB Interface and press \rightarrow.</p>
<p>USB Interface</p> 	<p>Please make sure that the default setting USB Interface for Customer is Always Off.</p> <p>If the FOCUS 35 total station needs a firmware upgrade, the USB interface setting must be set to <i>Always On</i> to complete the firmware upgrade.</p>
<p>Service Menu - System diagnose</p>	<p>Press \uparrow and \downarrow to scroll to System diagnose and then</p>

Screen	Actions and Comments
	<p>press .</p>
	<p>Service Menu - Run system diag. Press  and  to scroll to Run system diag. and then press .</p> <p>Show system state shows straightaway the most recently obtained diagnose results.</p>
	<p>System diagnose The diagnose program checks all instrument functions. During the diagnosis process, you may be prompted to turn the instrument knobs and be requested to aim to a prism. At the end the program shows the results and offers the possibility to store it.</p>
<p>Service Menu - External EDM Frequency</p>	<p>Press  and  to scroll to Ext. EDM Frequency and then press .</p>

Screen

Actions and Comments

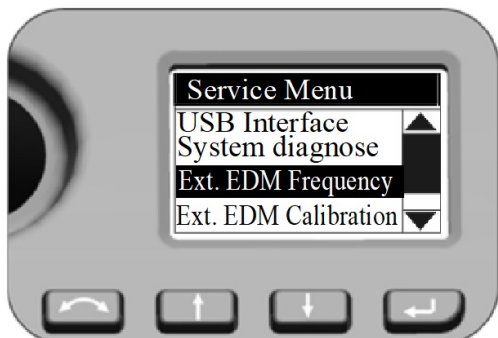

EDM Frequency

Press to switch on the EDM Laser source with modulated scale frequency.

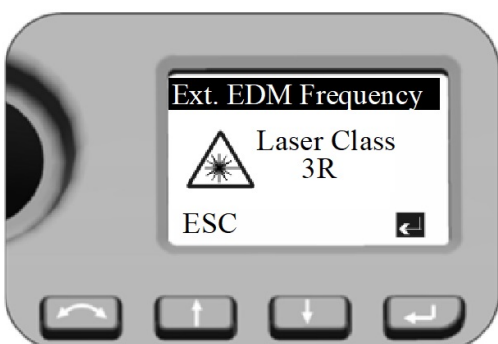

Press (**ESC**) to leave the menu.

EDM Frequency

The unit in frequency calibration mode produces visible Laser light emerging at the center of the telescope objective. The Laser light conforms to Class 3R. Make sure to do the external EDM frequency calibration appropriate to all warnings and precautions at Laser Safety (see [page 4](#)).

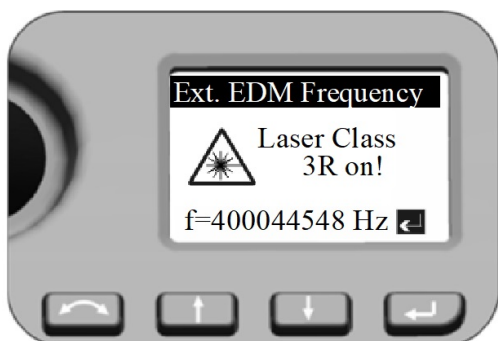

Nominal frequency will be displayed.

Press to leave the menu.

Service Menu - Ext. EDM Calibration

Settings after external EDM calibration:

Press or to scroll to **Ext.EDM Calibration** and press .

Both values for **External EDM Calibration** influence the measured distance directly! Therefore, they must have been determined by means of an accurate external calibration.

Screen

Actions and Comments

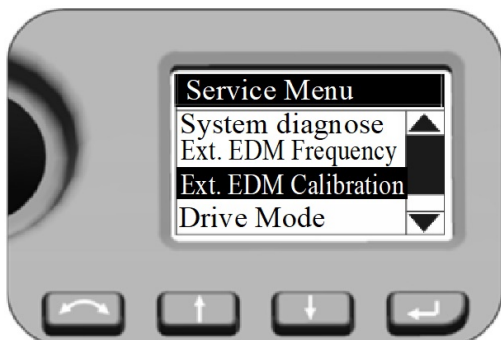

External EDM Calibration

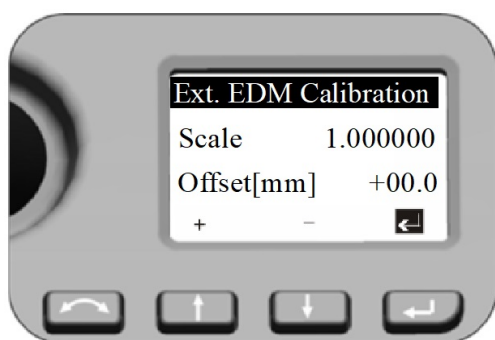

When entering this menu the cursor stays always at the key. Press when number is correct - the system jumps back to the **Service Menu**.

To enter another value press or and the first digit of the **Scale** is active (inverse) and with and the numbers 0-9 can be selected. Press when number is correct - cursor jumps to the next digit.

After you have selected the last digit for the **Scale** press . The cursor jumps to the settings for **Offset** with the same procedure.

When last digit of **Offset** is confirmed, the system jumps back with the cursor to the inverse symbol.

Press key a further time - the system jumps to **Service Menu**.

Service Menu - Drive Mode

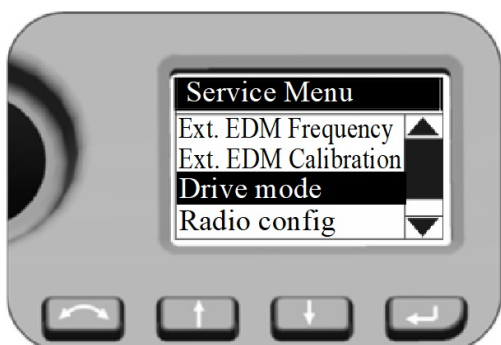









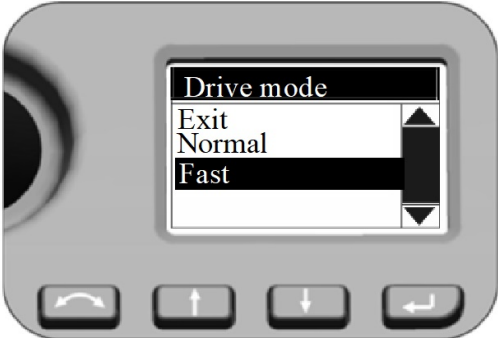

Drive Mode

Settings for Drive Mode

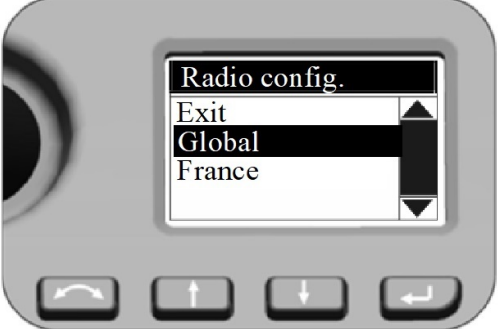
Drive Mode settings have an effect while using LockNGo Tracker technology for robotic surveying or while changing face.

Press and to scroll to **Drive Mode** and then press .

Press and to select *Normal* or *Fast* and then press .

Screen	Actions and Comments
	<p>Normal: This mode is the default mode. Mode is suitable for all instrument mounts.</p> <p>Fast: Mode can be a choice for instrument mount on tripods.</p>
<p>Service Menu - Radio configuration</p> 	<p>Setting Radio configuration</p> <p>Press  and  to scroll to Radio config. and then press .</p>
<p>Radio configuration</p> 	<p>Information to users in France only! To comply with French radio regulations, the radio must be set to French settings.</p> <p>Press  and  to scroll to France and then press .</p>
<p>Service Menu - Next Service Date</p>	<p>Setting Next Service date</p> <p>Press  and  to scroll to Next Service date and then press .</p>

Screen

Actions and Comments

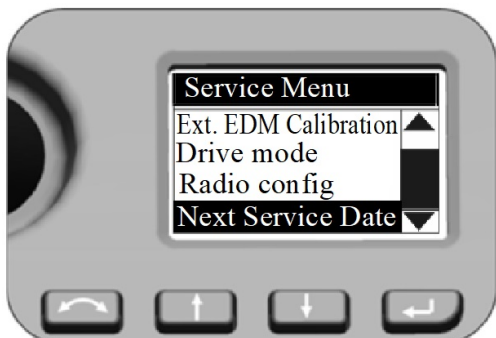

Next Service date

Press  to leave the menu.

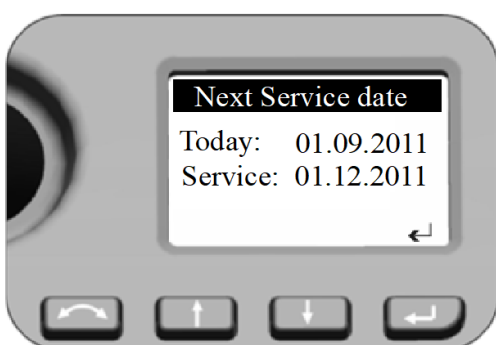

If the **Service** date is already expired the program offers the possibility to postpone the Next Service date (today plus three months). This change will be logged internally.

Instrument Adjustment and Calibration

The section describes the instrument adjustments and calibration routines, adjustments for Laser Pointer (see [The Laser Pointer, page 72](#)), for Optical Plummet (see [Optical Plummet, page 77](#)), and for Tribrach Circular Level (see [Tribrach Circular Level, page 79](#)).

These adjustments and calibrations will change over time, the most common changes being caused by:

- Wear and tear with use
- Bumps and knocks during transit
- Large changes in operating temperature

Spectra Geospatial recommends that a collimation and calibration check be carried out routinely as follows:

- After any long uncontrolled transport of the instrument (e.g., after service or shipment to a new location)
- After any accidental knock or drop
- At any time when the operating temperature changes by more than 10 °C (18 °F)
- At any time when the instrument changes its height above sea level by more than 500 m (1640 ft)

- At any time when the highest accuracy positions are required
- Routinely on a periodic basis (Monthly, weekly etc.)

Spectra Geospatial also recommends that the operator keep a record of the dates and values measured so that any gross changes can easily be detected. Gross changes can indicate the need for a check by an approved service center.

In all calibrations, multiple sightings will be made in both faces to ensure that any minor pointing errors can be eliminated in the accurate determination of current collimation error values. All measured collimation and calibration values are stored and used until a new set of values are determined.

In a new instrument the values should be close to zero, over time these will change.

Compensator

Before starting the routine, level the instrument. An internal instrument battery must be present in the side battery compartment. For instruments with Face 1 battery option, this battery compartment must be empty. The instrument will automatically check if the compensator is within range before the calibration is started.

The calibration process involves the instrument automatically reading the compensator value at a series of predetermined positions through the full rotation of the instrument. The process takes approximately one minute to complete. During the process the instrument should be on a stable platform, free from vibration and untouched by the user.

Optical (HA/VA) Collimation and Trunnion Axis Tilt

The FOCUS 35 Total Station instrument utilizes precise angle and distance measurements to determine the position of the point being measured. The instrument's design facilitates the ability to measure all points with a single pointing to the target in the Face1 position. All electronic total stations are subject to collimation errors in both the horizontal and vertical angle measuring systems, and also errors caused by the axis of the telescope not being truly perpendicular to the vertical of the instrument.

In order to compensate for these errors, the collimation routine allows the operator to accurately determine the current errors in the instrument, and store the errors as corrections to be applied to all measurements made in a single pointing to a target. In this way the FOCUS 35 Total Station will always provide accurate measurements.

The adjustment of the instrument for HA/VA collimation and Trunnion Axis tilt is a two stage process.

LockNGo Tracker



Only on Instruments with LockNGo capability:

The LockNGo Tracker unit is designed to be coaxial with the instrument cross hairs. If for any reason the alignment of the tracker deviates from the line of the telescope cross hairs, then errors in position of the point being measured would result. For this reason an LockNGo collimation check needs to be carried out on a regular basis to ensure that any slight misalignment is corrected for. Perform the test over a similar distance as that you will be working on, but at least 100 m (328 ft).

The prism target must be very still during the test (Spectra Geospatial recommends that you use a tripod or bipod mount for the target) and must be in clear line of sight without any obstructing traffic. The instrument is calibrated to accurately point at the center of the target in both horizontal and vertical axes. The calibration is used to correct the positions of all points measured using the LockNGo Tracker function.

Adjustment Routines in Survey Pro software (if available)

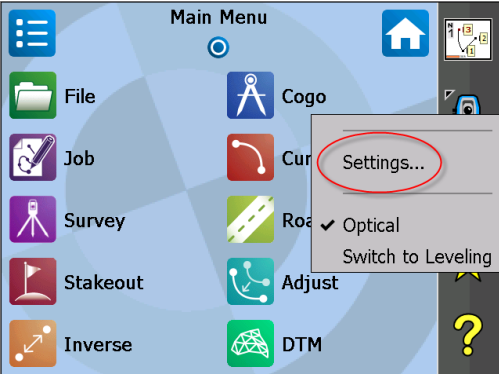
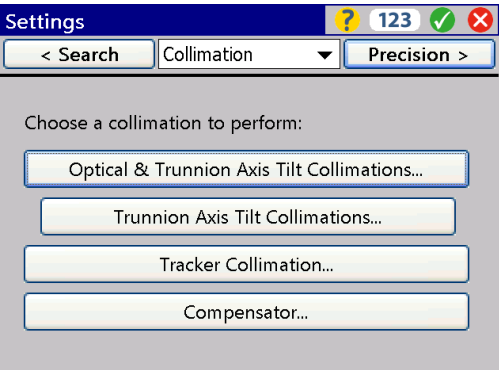
Start the Survey Pro software. During the process the instrument should be on a stable platform.

Screen	Actions and Comments
<p>Main Menu Survey Pro</p> 	<p>Select instrument Settings by tapping on this icon.</p>
<p>Settings Collimation</p> 	<p>Navigate to Collimation via drop down menu or toggle through the submenus with  key left or right. Select the appropriate adjustment.</p>

Optical Collimation

The workflow is structured as follows:

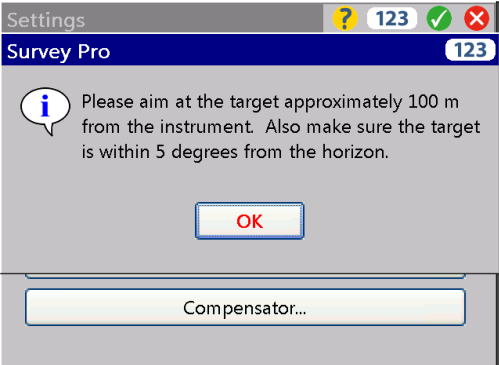
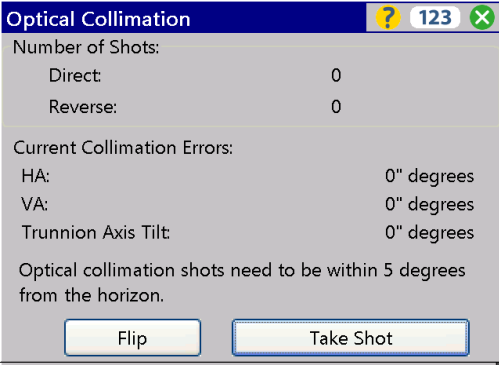
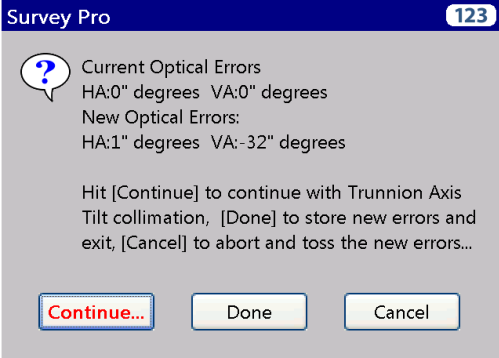
Screen	Actions and Comments
<p>Collimation conditions</p> 	<p>Make sure to measure with the stated conditions.</p>
<p>Optical Collimation measurements</p> 	<p>Make the measurements per the displayed information and confirm and store the values.</p>
<p>Optical Collimation / Trunnion Axis</p> 	<p>Decide per the displayed information for trunnion axis tilt collimation or confirm and store the new values for optical collimation.</p>

Tracker Collimation and Compensator Collimation

Start screens are:

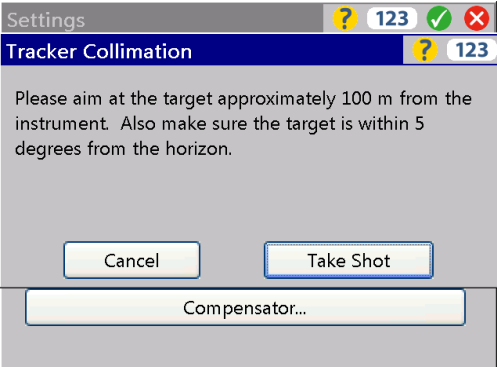
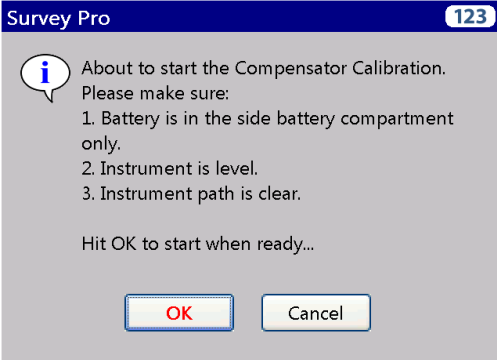
Screen	Actions and Comments
	Make sure to measure with the stated conditions.
	Make the measurements per the displayed information. During the process the instrument should be free from vibration and untouched by the user.

The Laser Pointer

The FOCUS 35 Total Station uses a red laser beam to measure and as a Laser Pointer. The Laser Pointer is coaxial with the line of sight of the telescope. If the instrument is well adjusted, the red Laser Pointer coincides with the line of sight. External influences such as shock or large temperature fluctuations can displace the red Laser Pointer relative to the line of sight.

Aligning the Laser Pointer

CAUTION – Viewing the laser spot on the adjustment target through the telescope is safe.

WARNING – Do not try to make the adjustment using a prism, see Laser Safety, [page 4](#).

WARNING – Do not use the Laser Pointer as an aid when searching for prisms, see Laser Safety, page 4.

To avoid faulty measurements using the Laser Pointer, use the supplied adjustment target to check the laser alignment regularly and before you attempt precise distance measurements:

Setup the adjustment target 10-15 meters (30-50 ft) away, facing the instrument.

Aim the instrument to the center of the target plate and then inspect the position of the red laser spot in relation to the telescope cross-hairs.

If the red laser spot lies outside the cross-hairs, adjust the direction of the beam until it matches the cross-hairs, see the Laser adjustment plate, below:

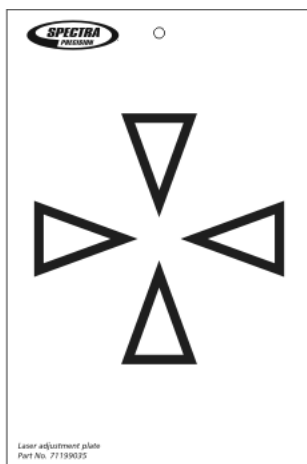

Adjusting the Laser Beam

Pull out the two plugs from the adjustment ports of the telescope housing:

The image shows the Laser beam adjustment ports.

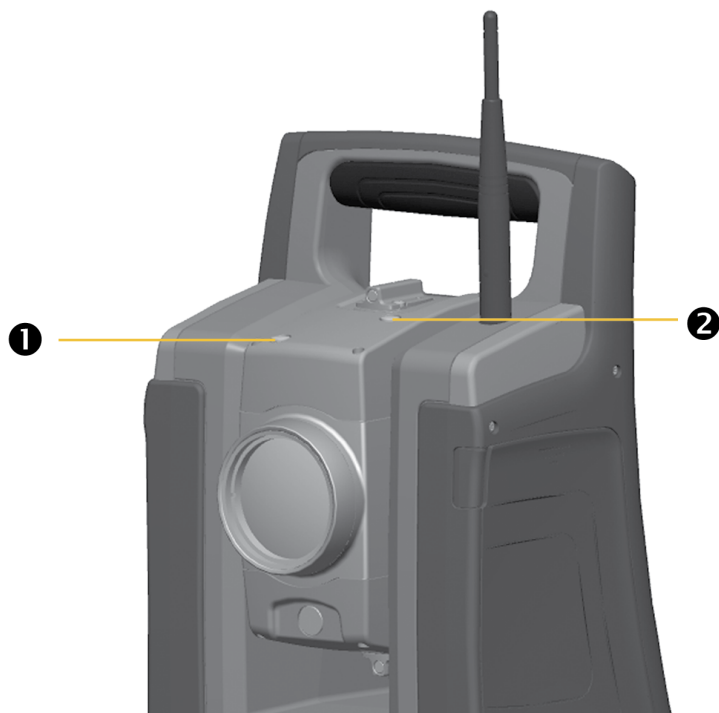

Item	Description
1	Vertical pointer adjustment port
2	Horizontal pointer adjustment port

To correct the vertical position of the laser spot, insert the allen key into the vertical adjustment port and turn it as shown:



To correct the horizontal position of the laser spot, insert the allen key into the horizontal adjustment port and turn it as shown:

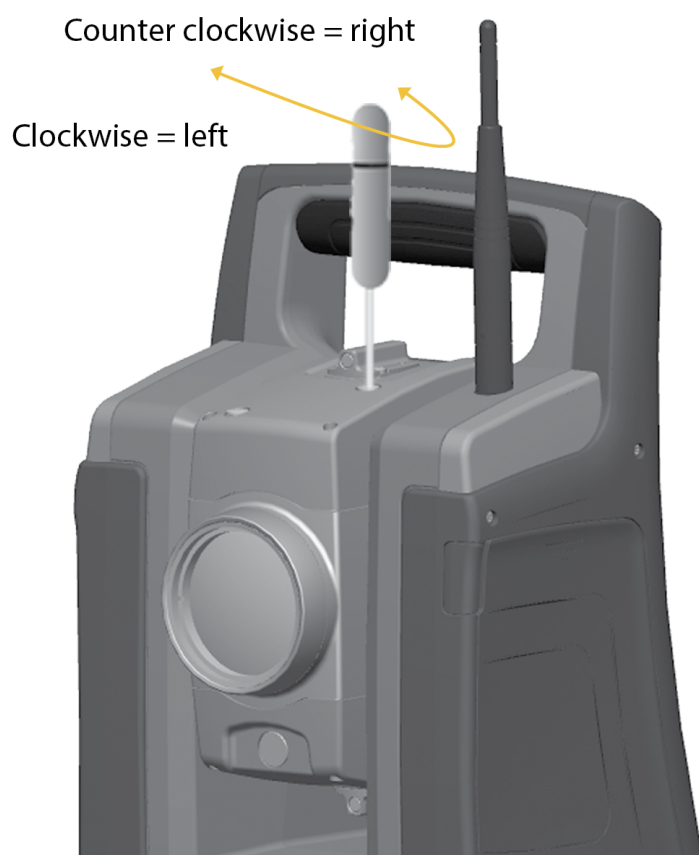

Check the alignment of the laser spot and the cross-hairs. Throughout the adjustment procedure, keep the telescope pointing to the adjustment target. The adjusting screws are of a high tension because they are self locking. The screws tighten automatically after you adjust them.

Refit the plugs in the adjustment holes. Make sure that the plugs are correctly fitted for proper sealing against the cover.

CAUTION - To keep out moisture and dust, make sure that the plugs are correctly fitted in the adjustment ports.

Optical Plummet

1. Set up the instrument and level it over a ground mark so that the tripod height is 1.5 m (± 0.1 m) (4.920 ft (± 0.328 ft)), see image below.
2. Note the position of the inner circle of the optical plummet in relation to the ground mark.
3. Turn the instrument 200 grads (180 degrees).
4. Note the position of the inner circle of the optical plummet in relation to the ground mark. If the inner circle of the optical plummet reticle moves in relation to the ground mark, you must adjust the plummet reticle location.
5. Adjust out half of the error with the four adjustment screws on the optical plummet.
6. Turn the instrument 200 grads (180 degrees).
7. If there is no movement between the inner circle of the optical plummet reticle in relation to the ground mark, no further adjustment is needed.

CAUTION - When adjusting the optical plummet with the four adjustment screws it is important that the screws are correctly adjusted. When one screw is adjusted the opposite screw must be adjusted equally in the reverse direction, in order to keep the correct tension on the optics. Do not overtighten the screws, this might damage the optics.

Optical plummet adjustment:



Item	Description
1	Optical plummet reticle 4x adjustment screws
2	Ground mark

Tribrach Circular Level

1. Level the instrument with the electronic instrument bubble.
2. Remove the instrument from the tribrach.
3. Use the provided adjustment key and adjust the bubble with the three bubble screws. The bubble must be centered.

CAUTION – When adjusting the Circular Level with the three adjustment screws it is important that the screws are correctly adjusted. When one screw is adjusted the two opposite screw must be adjusted equally in the reverse direction, in order to keep the correct tension on the Circular level. Do not overtighten the screws.

Circular Level adjustment:



Measuring the Instrument Height

There are two measurement marks on the side of the instrument. The top mark **1** corresponds to the trunnion axis of the instrument. The bottom mark **2** is 0.158 m (0.518 ft) below the top mark. Measure the bottom mark to the top ridge of the mark.

Instrument height marks:

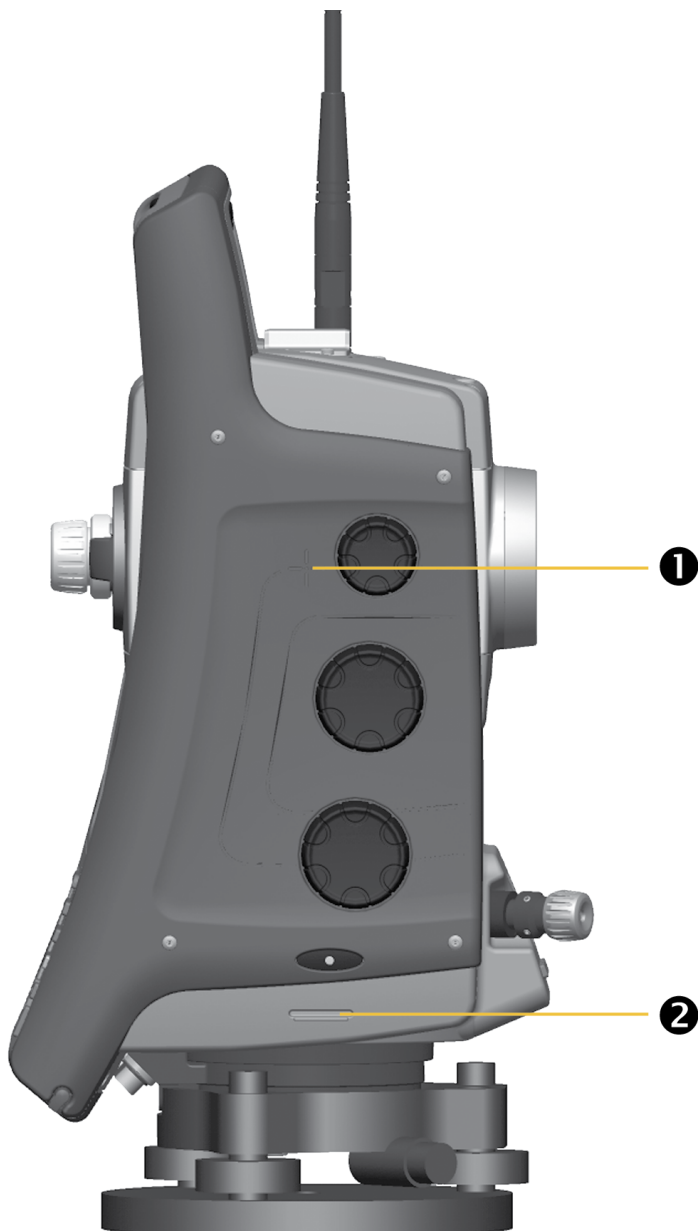

When the Survey Pro software is running, the software has additional functions that reduce the bottom mark measurement to the required vertical instrument height to the trunnion axis, see image below and the following paragraph.

Instrument height measurement:

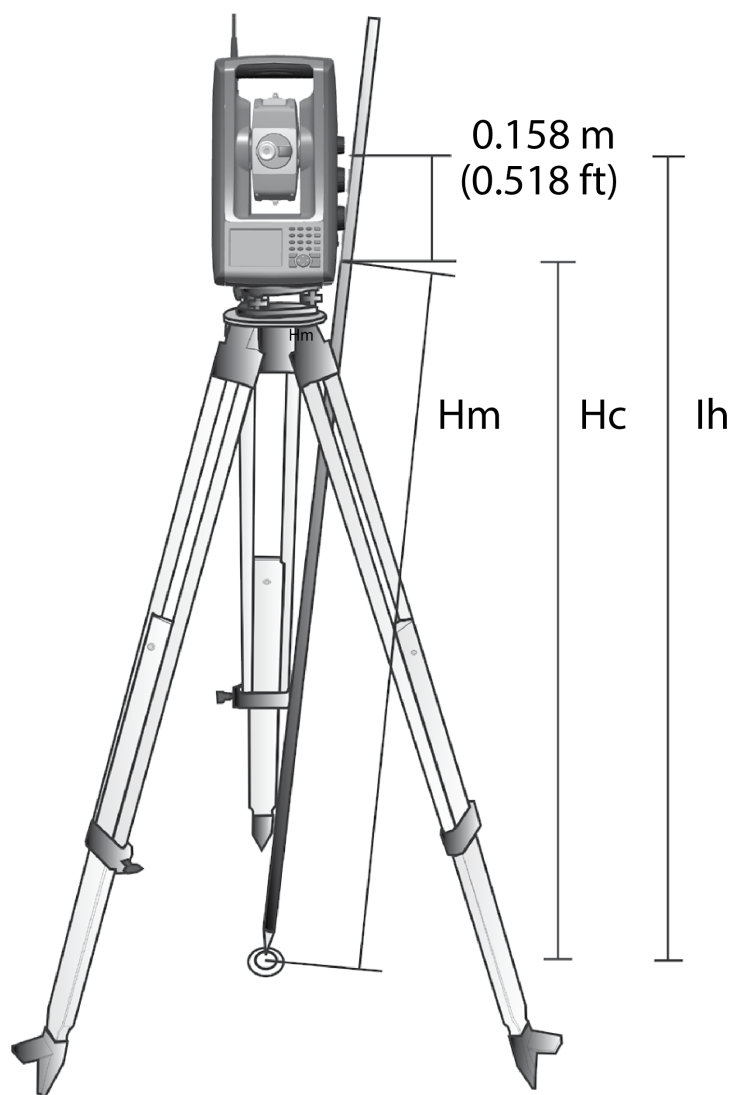

The measured distance (H_m) is corrected for the slope of the measurement to obtain a vertical measurement to the bottom mark (H_c). The constant from the bottom mark to the top mark (0.158 m/0.518 ft) is added to the H_c to obtain the vertical instrument height from the ground mark to the trunnion axis (I_h). For more information, refer to the Survey Pro documentation.

Alternatively, to obtain an accurate measurement to the top mark (I_h), you can manually measure the slope distance from the ground to the bottom mark (H_m). To calculate the total instrument height (I_h), insert the measured slope distance (H_m) into the formula below:

$$I_h = 0.158 + \sqrt{H_m^2 - 0.085^2}$$

Pre Measurement Check List

Before you begin measurement or stake out operations, check the following items:

- Lenses are clean
- Instrument is correctly leveled and Trunnion axis tilt
- HA/VA Collimation error
- LockNGo Tracker collimation error (if the instrument is equipped)
- Laser Pointer beam alignment
- Correct radio channel is selected (robotic measurements only)
- Measure instrument height
- Allow sufficient time for the instrument to adjust to the ambient temperature, see [Setup Stability](#)

Connecting to an External Data Collector

The Ranger™, T41™, and Nomad® handhelds and the ST10 rugged tablet can be used as data collectors for the FOCUS 35 Total Station.

The controller can be connected to the FOCUS 35 Total Station via Bluetooth® wireless technology or radio.

Connecting with Cable - LockNGo Instrument Version

The controller is connected from the FOCUS 35 Total Station COM port to the USB or the RS-232 connector.

Controller	Cable
Ranger	73840019-SPN or 53002021-SPN
Nomad	53002021-SPN
T41	67601-05 53002021-SPN
ST10	73840019-SPN

The image shows an external controller connected to the FOCUS 35 Total Station with cable for measurements.



Connecting with Bluetooth wireless technology - LockNGo Instrument Version

The data collector is connected directly to the instrument via Bluetooth wireless technology.

All models of the FOCUS 35 Total Station can be connected to a Bluetooth-enabled controller, though most configurations only allow for short-range communications. Beginning in July 2019, the LockNGo version of the FOCUS 35 total station contains Class 1 Long Range Bluetooth. When paired with a controller that also has Class 1 Bluetooth this allows for communications over Bluetooth up to 200 m away, without a radio.

Bluetooth range varies based on environmental conditions such as physical obstructions or interference from other nearby devices. Range also varies based on the transmitter strength and receiver sensitivity of both the controller and the FOCUS 35 total station.

LockNGo models whose part number begins with "7847" contain Class 1 Bluetooth. LockNGo models whose part number begins with "7844" contain Class 2 Bluetooth.

Connecting with Radio - Robotic and RX Instrument Versions

The data collector is connected to the instrument via the radio using one of two methods:

- Integrated: Data collector with integrated radio, connected directly to the FOCUS 35 total station.
- Radio bridge: Data collector connected to a radio bridge (an external radio), which can communicate with the FOCUS 35 total station. The external data collector is connected to the external radio via Bluetooth wireless technology.

5

Instrument Operational Methods

- ▶ Conventional Measurements with StepDrive Motor System
- ▶ LockNGo Measurement
- ▶ GeoLock Technology
- ▶ Robotic Measurement

Conventional Measurements with StepDrive Motor System

This chapter describes the following instrument operational methods for the FOCUS 35 Total Station:

- When combined with the application software:
 - When setting/staking out, the instrument calculates and automatically aims towards the calculated position of the selected point.
 - The instrument will automatically point towards a selected reference target to check for instrument movement during measurements.
- Instrument software corrects the collimation / trunnion axis tilt errors in real time.
- The StepDrive motor system are continuous and endless allowing for rapid repeat manual pointing of the instrument with no end stops.

NOTE - To obtain the correct point location with the instrument, you must aim correctly to the target.

LockNGo Measurement

Combining the StepDrive motor capability with the image-based tracking system provides the ability to carry out LockNGo measurements. LockNGo enables the instrument to automatically lock on to a prism, and then follow it precisely as it moves. This means that the instrument is taking care of the pointing, and that position can be continuously updated as the target moves around the jobsite. LockNGo is especially useful for carrying out rapid site topo measurements and during stakeout using a conventional two-person crew. It is also exceptionally useful for working in poor visibility and darkness conditions, and for automatically checking to reference targets during measurements.

GeoLock Technology

GeoLock™ technology is a feature of the Survey Pro software that allows a robotic total station to perform an aided search for an optical target using an initial GNSS position. The technology greatly reduces the time to locate and lock onto a target.

The GeoLock technique combines a GNSS position with the FOCUS 35 robotic total station and the robotic roving operator. The remote instrument can then be directed towards the robotic roving operator using the GNSS position and a subsequent search is quickly performed to reacquire the target at the robotic rover.

Robotic Measurement

Combining the StepDrive motor capability with the image-based tracking system and the radio capability enables the instrument to carry out measurements robotically. This enables a single operator to control the instrument and carry out measurements or set/stakeout from the rod at the point.

Instrument Technology

- ▶ Angle Measuring Technology
- ▶ Distance Measuring Technology
- ▶ Tracklight
- ▶ StepDrive Motor System and Focus System
- ▶ LockNGo Tracking Technology
- ▶ Power Management
- ▶ Instrument
- ▶ Robotic Configuration
- ▶ Power Supply
- ▶ External Communication
- ▶ Radio
- ▶ Bluetooth wireless technology

Angle Measuring Technology

The principles of angle measurement are based on reading an integrated signal over two opposite areas of the graduated circle and producing a mean angular value. This eliminates inaccuracies caused by eccentricity and graduation.

In addition, the angle measurement system compensates for the following automatic corrections:

- Instrument mislevelment (deviation of the plumb axis).
- Horizontal and vertical collimation error.
- Trunnion axis tilt, see [Correction for Trunnion Axis, page 89](#).

Correction for Mislevelment

The FOCUS 35 Total Station automatically corrects for mislevelments up to $\pm 5.5'$. The instrument warns the operator immediately of any mislevelments in excess of $\pm 5.5'$ (± 0.1 grads).

Corrections for the horizontal angle, vertical angle, and slope distance are calculated in the field application software and applied to all measurements.

Compensator Calibration

The calibration process involves the instrument automatically reading the compensator value at a series of predetermined positions through the full rotation of the instrument. The process takes approximately one minute to complete. During the process the instrument should be on a stable platform, free from vibration and untouched by the user.

Spectra Geospatial recommends that you regularly carry out a compensator calibration, especially in the following situations:

- Whenever the instrument may have been roughly handled during transport.
- When the ambient temperature differs by more than $10\text{ }^{\circ}\text{C}$ ($18\text{ }^{\circ}\text{F}$) from the previous calibration test temperature.
- Immediately prior to high precision angle measurements in one face.

Correction for Collimation Errors

HA/VA Collimation

The horizontal collimation error is the deviation of the sighting axis from its required position at right angles to trunnion axis.

The vertical collimation error is the difference between the vertical circle zero and the plumb axis of the instrument.

Traditionally, collimation errors were eliminated by observing angles in both instrument faces. In the FOCUS 35 Total Station, a pre-measurement collimation test is performed to determine the collimation errors. Angular measurements are observed in both instrument faces, the collimation errors are calculated, and the respective correction values are stored in the instrument. The collimation correction

values are then applied to all subsequent angle measurements, including the distance related focus lens collimation error. Angles observed in a single face are corrected for collimation errors, which eliminates the need to measure in both instrument faces.

Carry out a collimation test in the following situations:

- Whenever the instrument may have been roughly handled during transport.
- When the ambient temperature differs by more than 10 °C (18 °F) from the previous collimation test temperature.
- Immediately prior to high precision angle measurements in one face.

FOCUS 35 Total Station with LockNGo Tracker

A FOCUS 35 Total Station with LockNGo capability can automatically lock and track a prism target as it moves. Pointing errors caused by slight misalignment of the instrument's tracker have a similar effect to the HA and VA Collimation errors as detailed above.

To correct for the tracker collimation errors, carry out a LockNGo Tracker collimation test. The LockNGo Tracker collimation test automatically observes angular measurements to a target in both faces, the tracker collimation errors are calculated and the respective correction values are stored in the instrument.

The collimation correction values are then applied to all subsequent angle measurements observed when LockNGo Tracker is enabled. Angles observed in a single face are corrected for collimation errors, which removes the need to measure in both instrument faces.

Carry out a LockNGo Tracker collimation test in the following situations:

- Whenever the instrument may have been roughly handled during transport.
- When the ambient temperature differs by more than 10 °C (18 °F) from the previous collimation test temperature.
- Immediately prior to high precision angle measurements in one face.

Correction for Trunnion Axis

The trunnion axis tilt error is the deviation of the trunnion axis of the telescope from its required position at right angles to the plumb axis of the instrument.

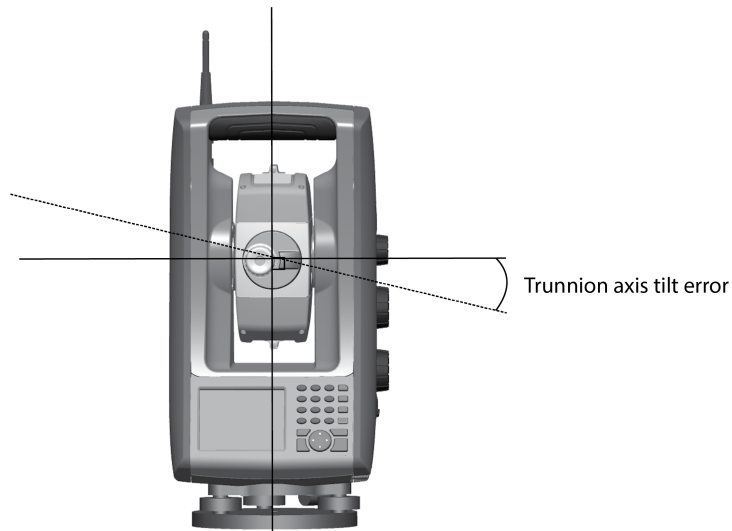

In the FOCUS 35 Total Station, perform a pre-measurement trunnion axis tilt test to determine the trunnion axis tilt error. Angular measurements are observed in both instrument faces, the trunnion axis tilt error is calculated, and the respective correction value is stored in the instrument. The trunnion axis tilt correction value is then applied as a correction to the horizontal angle value.

- Carry out a trunnion axis tilt test in the following situations:
- Whenever the instrument may have been roughly handled during transport.
- When the ambient temperature differs by more than 10 °C (18 °F) from the previous collimation test.
- Immediately prior to high precision angle measurements in one face.

Averaging Measurements to Reduce Sighting Errors

The FOCUS 35 Total Station automatically reduces sighting errors caused by the misalignment of the instrument to the target or by pole movement during measurement.

The following techniques can be used:

- Use LockNGo Tracker. When LockNGo Tracker is enabled, the instrument automatically locks onto and tracks the target. Manual sighting errors are reduced.
- Automatically average angles during distance measurement. When measuring in Standard mode, the instrument takes angle measurements while measuring the distance. Angles returned to the instrument at 200 Hz, are averaged over this period to obtain an averaged angle measurement.
- Use average measurement methods in the field software.

Distance Measuring Technology

Spectra Geospatial FOCUS 35 Total Stations are equipped with a combined distance unit. This means that the instrument can measure to a prism or to normal surfaces (reflectorless mode).

The laser distance unit is based on the phase comparison method. The distance unit is coaxial with the line of sight and transmits an intensity modulated optical measuring beam that is reflected by a prism or scattered by a natural surface on which the beam is directed. The phase difference between the transmitted light and the reflected received light is detected and represents the distance.

In prism mode, the unit operates as a fast and precise long-range distance meter. In reflectorless mode, the unit transmits a collimated visible red laser beam to the target point and then calculates the distance between the transmitted and the received light.

The distance unit software will detect erroneous single distance measurements such as those caused by an obstruction passing through the measurement beam, and will ignore such readings in the computation of the final distance.

The unambiguous range for distance measurement is as follows:

- Prism mode - 7,350 m (24,114 ft)
- Reflectorless mode - 1,100 m (3,609 ft)

NOTE - Do not measure to a prism in reflectorless mode. Distances up to 1100 m (3,609 ft) are not allowed because a Class 3 Laser is used for reflectorless distance measurement. For distances longer than 1100m (3,609 ft), the instrument's distance accuracy is not guaranteed.

Beam Divergence

All distance meter measurement beams diverge as the range from the instrument increases. The divergence of the distance meter beam relates to an increase in the size of the area being sampled, not to a degradation of the measurement precision.



A larger measuring area at longer range is generally better because it enables smaller objects, such as power lines and antennas, to be detected and accurately measured. With a smaller measuring area, these small objects can be easily missed. A smaller measuring area has advantages when measuring tight corners and vertices at close range. When observing measurements to a tight corner, the distance meter beam divergence introduces a range error caused by the size of the sampling area.

Measuring to an inner and outer corner:

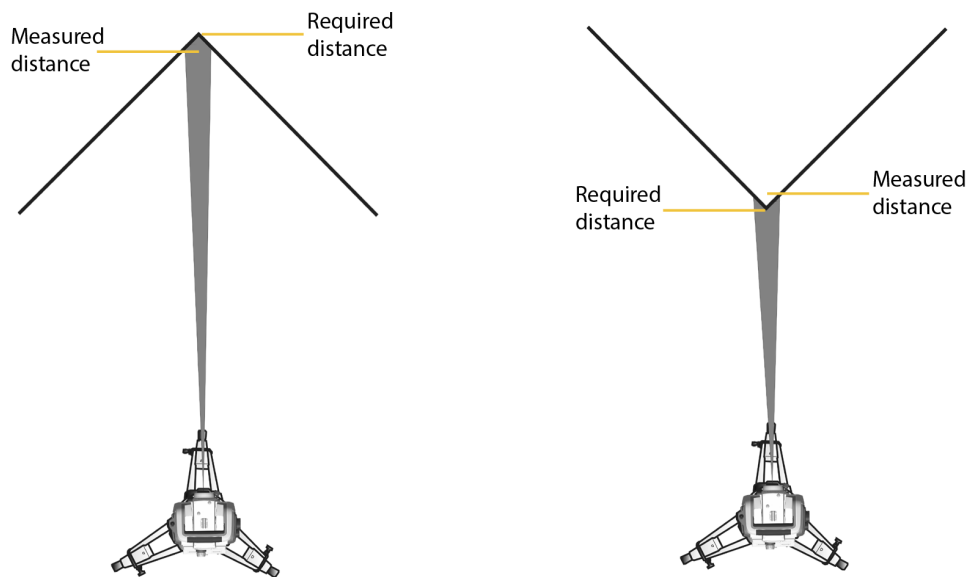

Although the problem is reduced with a beam that uses a smaller measuring area, the error can not be completely eliminated. The most accurate solution to measure to tight corners and eliminate errors caused by beam divergence, is to use an offset measurement method such as that used in the field application software.

Do the following:

1. Measure two points on the face of the building.
2. Aim the instrument at the corner to store the correct horizontal and vertical angle.

Offset measurement:

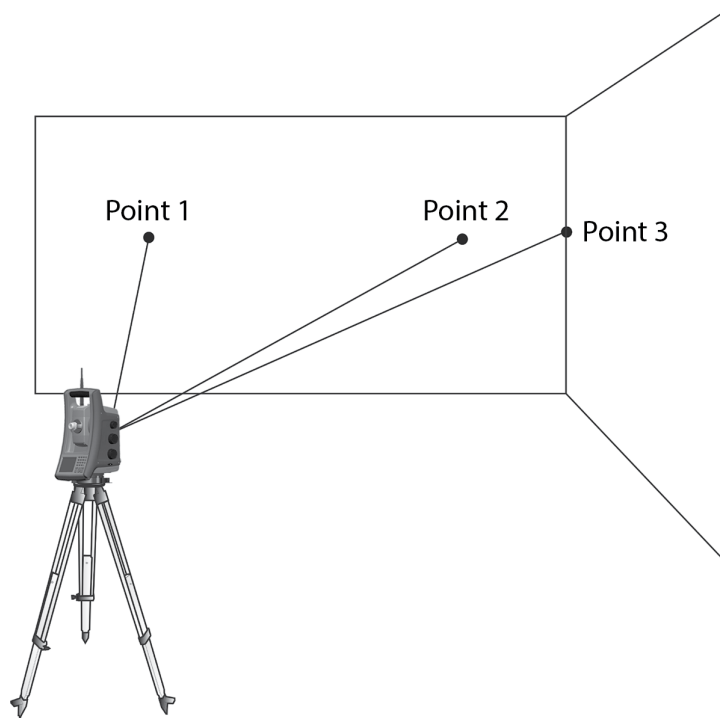

With offset measurements, you can accurately measure difficult locations in reflectorless mode and eliminate beam divergence errors. For more information, refer to the field application software documentation.

Tracklight

Tracklight is a visible guide light that enables the rod holder to position themselves into the instruments current line of sight. The tracklight can be used during stakeout in all operational modes, and is also of great benefit when operating in robotic mode as a means of checking that the instrument is tracking, or when trying to reacquire lock by walking into the sight line of the LockNGo Tracker, or using the remote joystick control in robotic mode. Tracklight consists of a flashing two-colored light, with each color lying in its own lateral projection sector. If the rod holder is to the left of the measuring beam, they will see a red flashing light; if they are to the right, they will see a green flashing light.

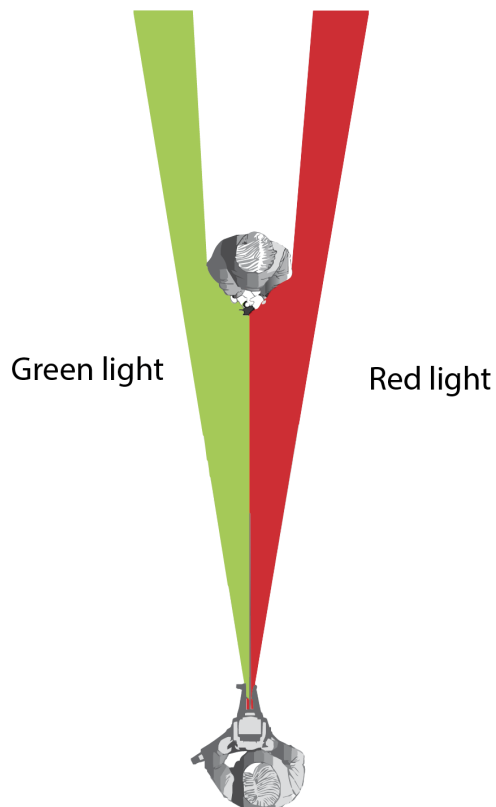

TIP - You can use the tracklight for clearing sight lines and as an aid to find prisms in the dark or unfavorable sighting conditions.

WARNING - Do not use the Laser Pointer as an aid when searching for prisms, the reflected light can dazzle your eyes. The reflected light will not damage your eyes, but might be uncomfortable, see also Laser Safety, [page 4](#).

StepDrive Motor System and Focus System

The FOCUS 35 Total Station is equipped with a StepDrive motor system to position the instrument and the telescope and a servo drive to focus the telescope.

Due to the instrument accuracy it is important to use a high quality tripod and tribrach. It is also important to set up the tripod in a position for best stability, as shown. An unstable setup that could negatively influence the resulting measurement precision.



Stable setup

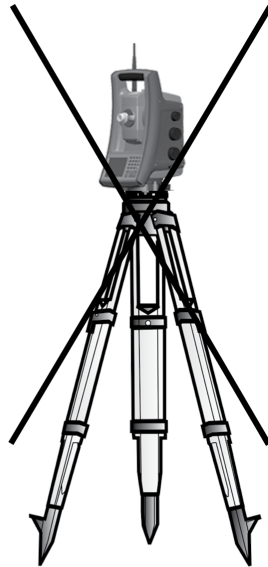

Unstable setup

StepDrive

The StepDrive motor system is a mechanical rough-fine drive system, which gives high turning speeds and accuracy. The system provides endless horizontal and vertical motion, including endless fine adjustment. The instrument uses a StepDrive motor system when performing a number of different operations such as turning the horizontal and vertical motion knobs, for automatic test and calibration, or when using LockNGo Tracker technology for robotic surveying, see image below.

Please see also [Settings for Drive Mode, page 66](#).

Position StepDrive motion knobs:



Item	Description
1	Vertical motion knob
2	Horizontal motion knob

Focus System

The instrument is equipped with a motor focus drive. The focus motion knob is on the side of the instrument for easy access.

The focus knob is connected to a servo motor that is built into the telescope. When you turn the focus motion knob, the servo motor adjusts the focusing lens.



LockNGo Tracking Technology

The FOCUS 35 Total Station is equipped with an image-based tracking system, which is used for robotic or conventional measurements to lock onto and track a prism.

LockNGo tracking technology controls the instrument StepDrive motor systems and aims the instrument correctly towards the target.

TIP - To assure maximum performance from the LockNGo tracking technology keep the lens clean and dry.

The FOCUS 35 Total Station LockNGo tracking function:

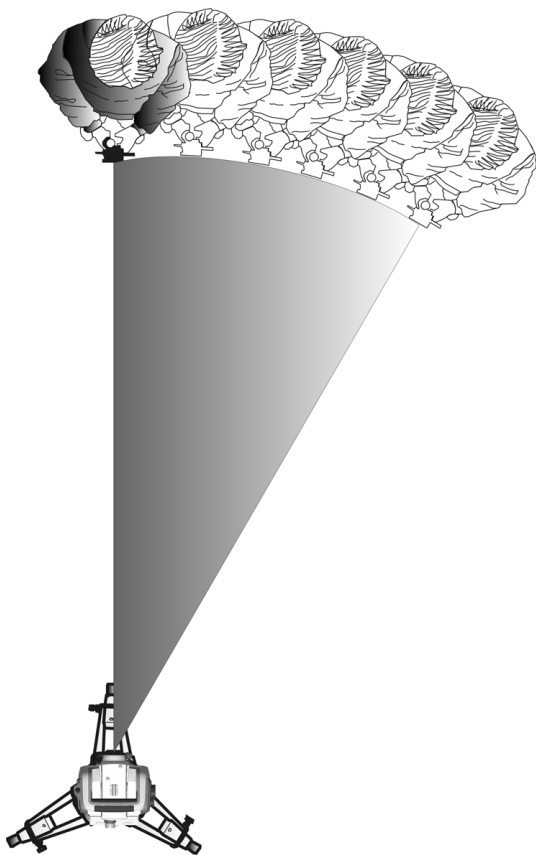

The FOCUS 35 Total Station can lock onto and track a prism.

Power Management

The power management in the FOCUS 35 Total Station instrument can set the instrument to one of three different modes.

- **Off Mode**
- **On Mode** - all instrument functions
- **Suspend Mode** - to save power and replace empty battery

NOTE – Saving power is also possible with an economical use of the Control Unit Face1 Backlight, for settings see [Display Backlight Face1 Control Unit, page 33](#).

Instrument

Off Mode

- Press the Trigger key for 1 second (single beep) to turn on the instrument.

NOTE – During Off Mode the Trigger key LED is off.

On Mode

- When starting the instrument it will enter a **Waiting mode**, where it will wait for an external connection for about 5 minutes. While in waiting mode the Trigger key LED will flash once every second and Face2 Display will show “Waiting”. During this time it is possible to start the application program, or prepare the settings for robotic measurements. The StepDrive motor system and Focus System are usable during this time.
- If the instrument is not used for 5 minutes (default) the instrument will go to **Suspend Mode** and Face2 display will show “Waiting (suspend)”.
- To turn Off the instrument press the Trigger key for 3 seconds - one beep and one double beep.
- The instrument will automatically enter **Suspend Mode** when the battery (including the Face 1 battery, if available) is removed.
- The instrument will go to **Suspend Mode** if the battery is low (battery capacity less than 5%), which enables you to replace the battery within a period of 10 to 15 minutes.
- Without replacing the battery the instrument will go to **Off Mode** if the battery capacity is less than 2% and any unsaved data will be lost.

NOTE – During On Mode the Trigger key LED will be on solid.

Suspend Mode

- You can resume working from the same place in the software that you were before you entered **Suspend Mode**.
- You can replace a discharged battery with a charged one within a period of 30 seconds.
- In the suspend mode the Radio and the Face2 display will be enabled. Face2 display will show “Waiting (suspend)”.
- To turn the instrument On, press the Trigger key for one second (one beep) or connect to the instrument from a remote application.
- To turn the instrument Off, press the Trigger key for 3 seconds.
- In **Suspend Mode** the instrument will turn Off automatically at suspend time out (default 120 minutes).

NOTE – During Suspend Mode the Trigger key LED will flash once every five seconds.

Robotic Configuration

A separate control unit is via cable or radio connected with the instrument. For starting the instrument see [Instrument, page 98](#).

On Mode

- If the instrument is controlled by a separate controller the instrument will not go into **Suspend Mode** while the battery is charged.
- For setting the instrument to suspend mode shut down the radio or cable connection between instrument and separate control unit, and the instrument will enter suspend mode. The instrument will turn Off automatically at suspend time out (default 120 minutes).
- The instrument will go to **Suspend Mode** if the instrument battery is low (battery capacity less than 5%), which enables you to replace the instrument battery within a period of 10 - 15 minutes with detailed information and warnings.
- Without replacing the battery the instrument will go to **Off Mode** if the battery capacity is less than 2%.

Power Supply

The power management in the FOCUS 35 Total Station has been designed to deliver the most operating time in the field. The power management system includes the internal battery, optional external power supply and the battery charger.

Internal Power Supply

The primary power supply for the FOCUS 35 Total Station is a rechargeable, removable Lithium-ion battery.

Second Internal Power Supply

On available models, a second internal battery can be inserted in the Face 1 battery compartment. This battery is treated as an external power source and power is used from this battery before the main internal battery is used.

External Power Supply

The FOCUS 35 Total Station has one external port in the base of the instrument for communication and for external power supply. External power can be provided by a car battery with an appropriate cable.

External Communication

The communication port on the base of the FOCUS 35 Total Station can be used for external communications to a computer or data collector.

CAUTION – Use only the gray cables with 6-pin Hirose connectors from Spectra Geospatial when connecting a cable to the instrument.

Radio

The FOCUS 35 Total Station (Robotic and RX versions) has an internal radio to support robotic operations. The internal radio is a 100 mW radio that operates in the public free 2.4 GHz band. The radio uses frequency hopping technology to reduce radio interference and maintain radio communications in even the harshest RF environment. The FOCUS 35 Total Station radio baud rate is 115200 bps. This high baud rate reduces the measurement latency, which ensures that a measurement viewed at the pole is received 100 msec after the measurement is sent from the instrument.

To maintain radio communication with the instrument, the controller at the pole must also be connected to a 2.4 GHz external radio or have an internal radio. The Ranger 7 and Ranger 3 handhelds are available with 2.4 GHz radios.

Bluetooth wireless technology

The FOCUS 35 Total Station can also use Bluetooth wireless technology for external communications. The Bluetooth baud rate is 115200 bps.

Accessories and Options

- ▶ Rod and Prisms
- ▶ Robotic Components
- ▶ External Radio
- ▶ Cables for External Power Supply and Data Transfer
- ▶ Control Unit Screen Protector
- ▶ Transport Case Accessories

Rod and Prisms

Spectra Geospatial Standard Rod

The Spectra Geospatial standard rod is available with the FOCUS 35 Total Station. The rod contains the following features:

- Graduated scale in Meter and Feet
- Fixed target height position
- Leveling bubble

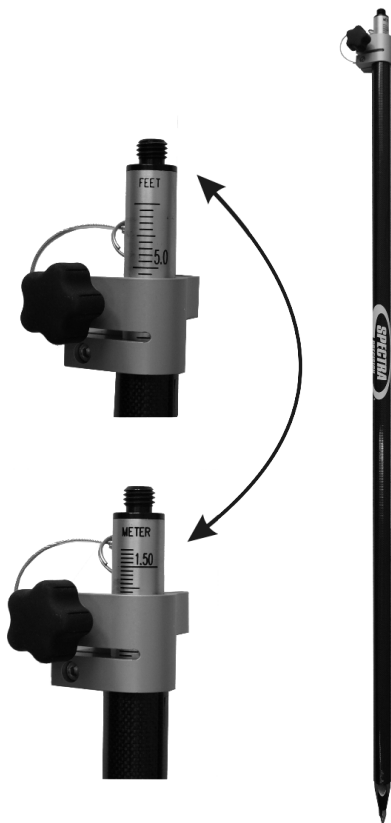

Spectra Geospatial 360 Degree Prism

This is a 360° prism comprising 7x25 mm prisms, h:135 mm, prism constant 2 mm. While using this prism adapter the height can be directly determined at the Spectra Geospatial standard rod.

NOTE - The FOCUS 35 total station is a passive tracking device that allows users to measure and track a variety of prisms. Necessary prism constants and quality checks are recommended to maintain high-accuracy measurement results.

The 360 Degree prism including height adapter:



Robotic Components

Robotic rover - for robotic operation there are two ways of external 2.4 GHz radio setup:

- Radio implemented in external CU like the Ranger 7 or Ranger 3 data collector (radio option)
- Separate external radio connected to the data collector via Bluetooth wireless technology

External Radio

An external radio is available as an option for robotic measurements when using a controller not fitted with an internal radio. The external 2.4 GHz radio can operate for 36 hours. This will give the radio 15 hours with a 2.4 Ah battery. For technical information, see [Radio](#).

External radio 2.4 GHz:



For information regarding charging of the battery, see [Charging the Instrument Batteries](#).

CAUTION – Always remove the battery from the external radio after use.

Cables for External Power Supply and Data Transfer

Cable for External Power Supply

Cable between the car battery and instrument with crocodile clips and Hirose 6 pin.

Cable - 3.0 m (10 ft):



Cable for Data Transfer

Cable from the instrument to PC with Hirose 6 pin and USB-A plug.

Cable - 2.5 m (8 ft):



Cable from the instrument to BD9 female RS-232.

Cable - 2.5 m (8 ft):



Cable from the instrument to USB flash card memory with Hirose 6 pin and USB-A socket.

Cable - 0.18 m (0.6 ft):



Control Unit Screen Protector

Screen protector set for the FOCUS 35 Total Station.

Control Unit Face1 (if available). Package consists of two pieces with dust-free cloth and installation card.

Two versions are available:

- ULTRA-Clear
- ANTI-Glare



Transport Case Accessories

Carrying Straps

Carry Strap for Transport Case, two required.



