

Set Up Instructions

WLBS-36089FR BANNER STAND

Step 1: Assemble straight poles by pressing and pushing together.

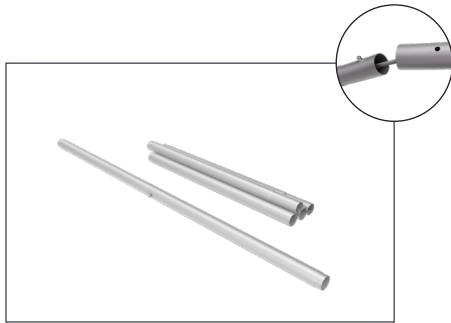

Step 2: Connect all corner sections to straight sections. Face holes of 90° corners towards the bottom of frame. Insert center support pole.

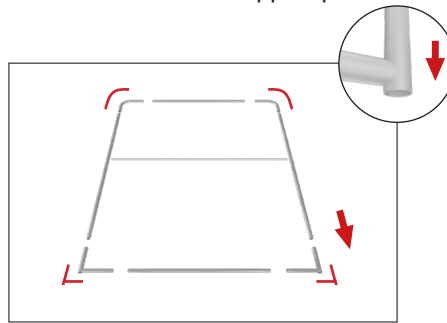

Step 3: Unzip print and lay image face up. Slide print onto frame like a pillow case.

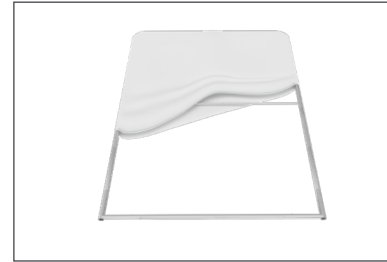

Step 4: Grip the fabric tightly and stretch around bottom pole to pinch zipper into place. Zip the graphic together for taut finish.

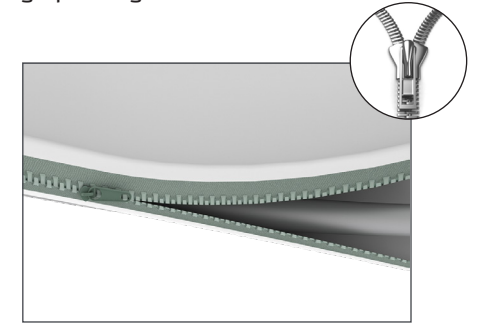

Step 5: Assemble post (75) into base plate or optional feet with screw by hand turning post and tightening into place.

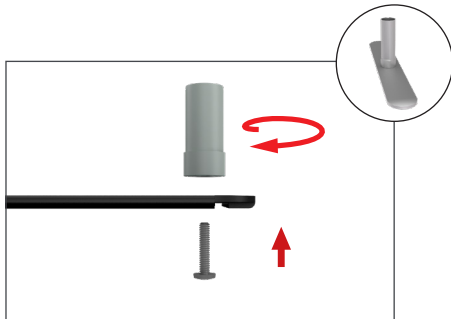

Step 5: Push banner stand frame onto posts of flat base or optional feet. Press evenly on both sides to make easier for the frame to go on.

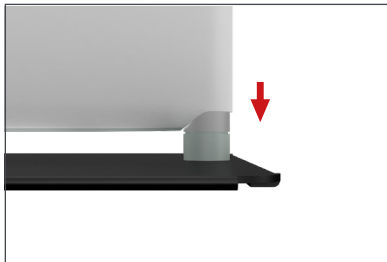

LIGHTS:
(OPTIONAL) Position as desired and tighten knob to hold in place.
WARNING! Over tightening may cause damage to fabric image.

