

Set Up Instructions

MDSR-36060FS

Step 1: Assemble straight poles by pressing and pushing together.

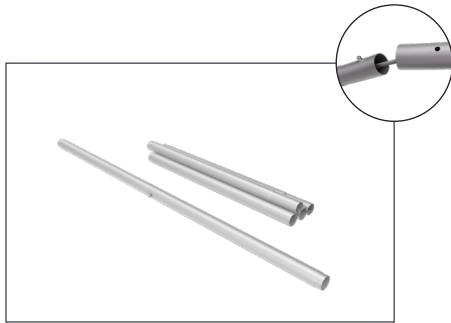

Step 2: Connect all corner sections to straight sections. Face holes of 90° corners towards the bottom of frame.

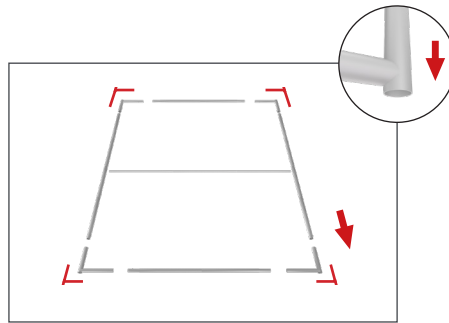

Step 3: Insert center support pole.

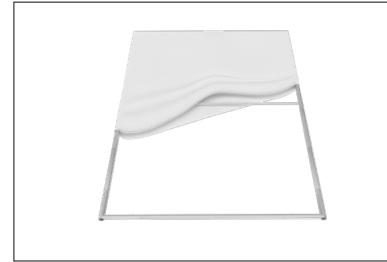

Step 4: Grip the fabric tightly and stretch around bottom pole to pinch zipper into place. Zip the graphic together for taut finish.

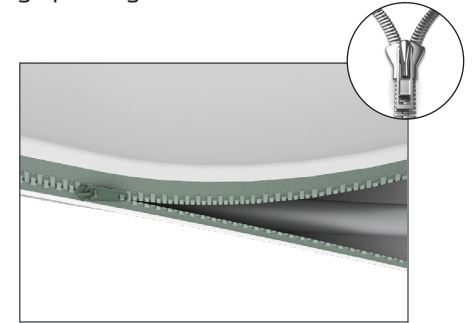

Step 5: Assemble post (75) into the 4 corners of the base plate with screw by hand turning post and tightening into place.

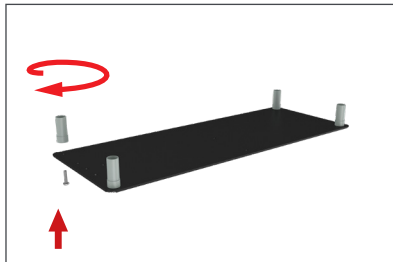

Step 6: Push banner stand frame onto back posts of flat base or optional feet. Press evenly on both sides to make easier for the frame to go on.

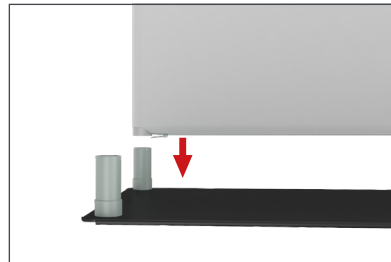

Step 7: Assemble x2 - (85) and (87) together and push poles into top of frame and front two posts (75).

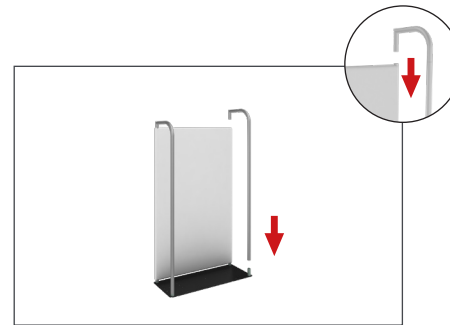

SHELVING & ACCESSORIES:
(OPTIONAL) To add shelves or accessories to frame, position and level part on frame before tightening clamps down with hex tool.

