

Set Up Instructions

IFD-H-04F HARDWARE

Step 1: Assemble base parts and poles by pressing and pushing together. Use hand tool when shown.

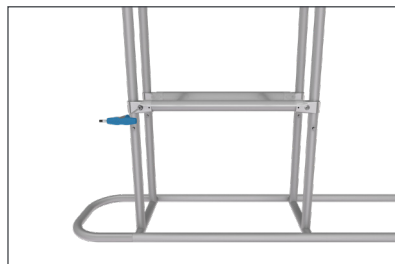
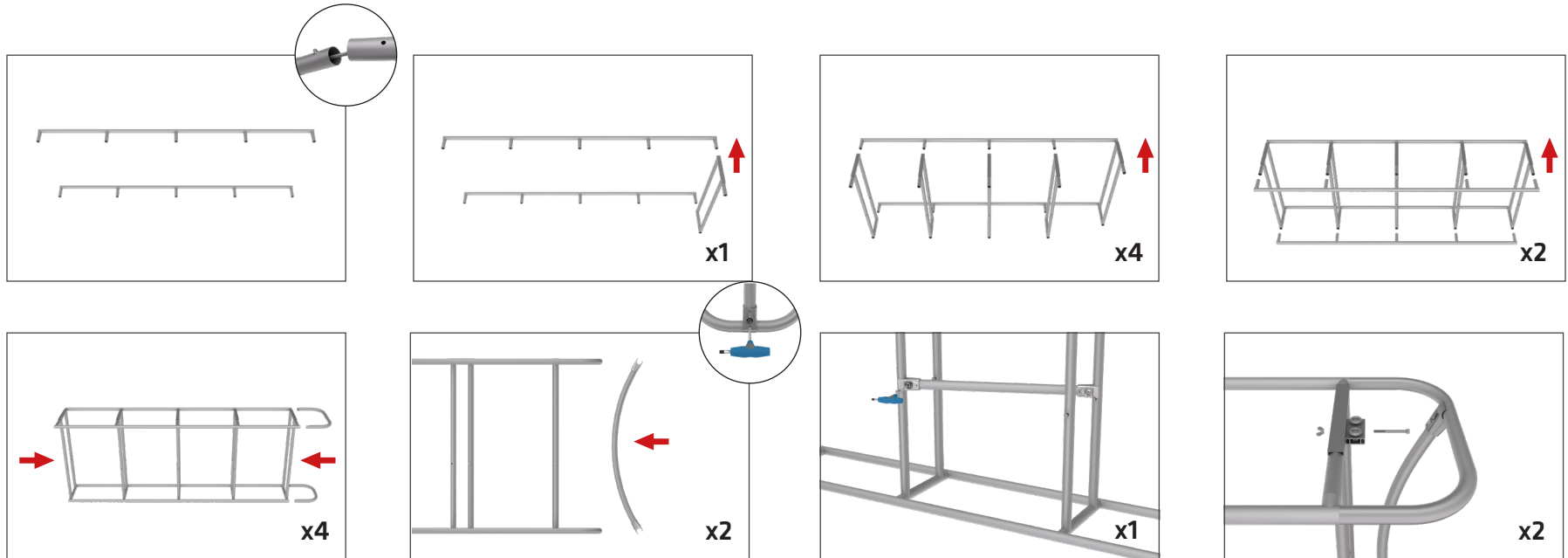

SHELVES:
(OPTIONAL) To add shelves to frame, position and level shelf on frame before tightening clamps down with hex tool.

*Shelves will only fit on the two outermost interior frame sections.

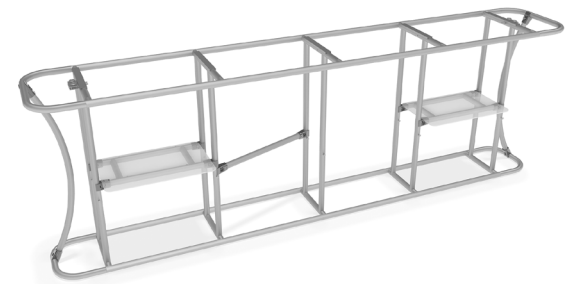

Set Up Instructions

IFD-H-04F GRAPHIC & COUNTER TOP

Step 1: Unzip print and slide print onto frame like a pillow case.



Step 2: Grip the fabric tightly and stretch around bottom of desk to pinch zipper into place. Zip the print together for taut finish.

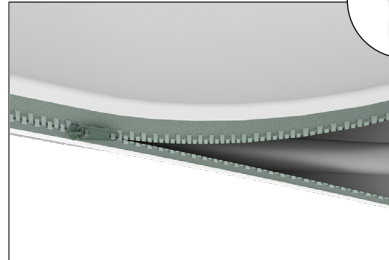

Step 3: Attach countertop panels to fabric counter with Velcro. Start at one end and work your way across to the other side.

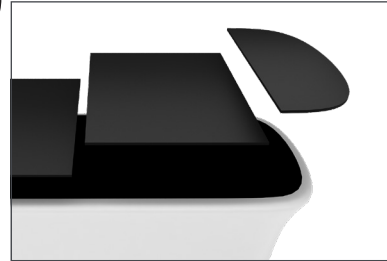

Step 4: Join counter top panels together front and back with black push-on clamps.

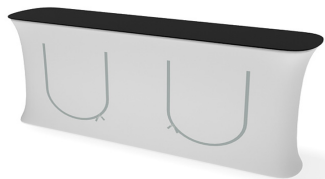
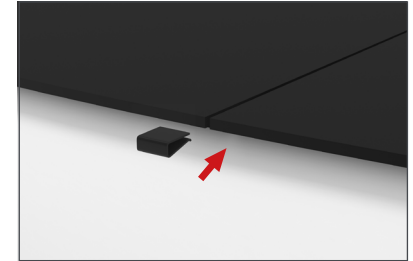

STORAGE ZIPPER:
(OPTIONAL) Zipper access to shelving and storage.

