

Set Up Instructions

HSSA-H-2460F (500ml)

Step 1: Assemble straight poles by pressing and pushing together.

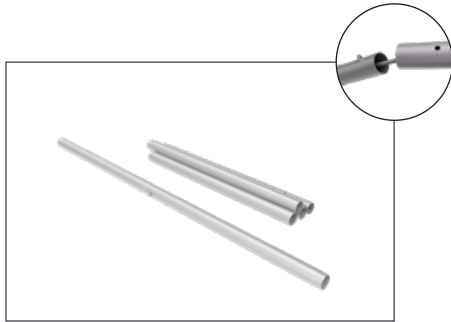

Step 2: Connect all corner sections to straight sections. Face holes of 90° corners towards the bottom of frame.

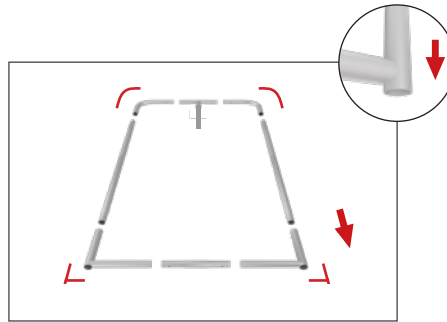

Step 3: Unzip print and lay image face up. Slide print onto frame like a pillow case.

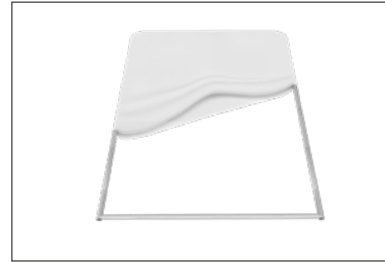

Step 4: Grip the fabric tightly and stretch around bottom pole to pinch zipper into place. Zip the graphic together for taut finish.

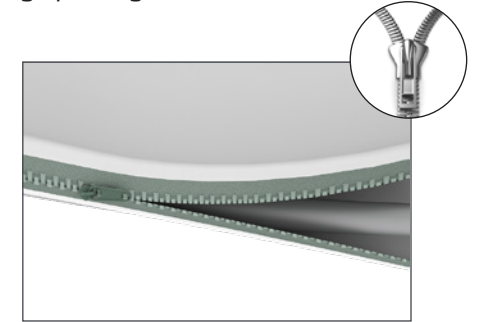

Step 5: Assemble post (75) into base plate or optional feet with screw by hand turning post and tightening into place.

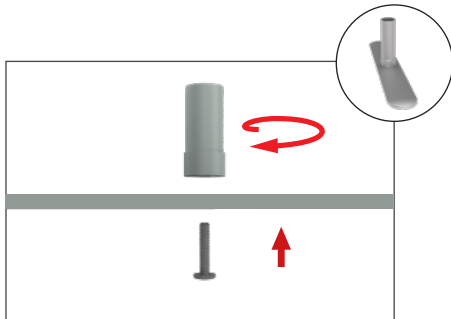

Step 6: Push banner stand frame onto posts of flat base or optional feet. Press evenly on both sides to make easier for the frame to go on.

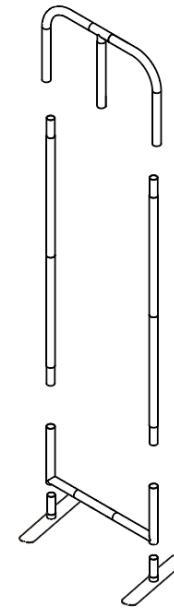

Set Up Instructions

HSSA-H-2460F (500ml)

Step 7: Find the bottom support post hole and cut a small X over bottom hole only. **Important!** Top hole should not be used or dispenser will cover text above.

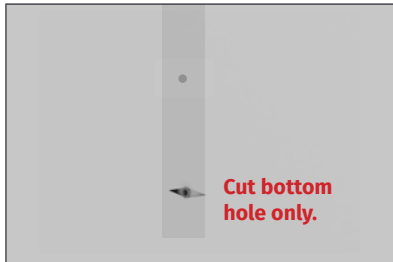

Step 8: Install dispenser mount with one screw in top mount only..

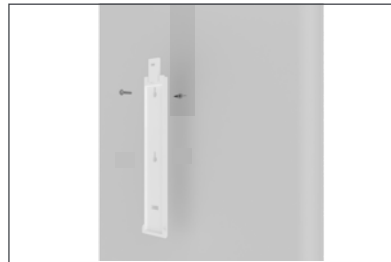

Step 9: Slide dispenser onto mount and press down.



Step 10: Install x4 AA Batteries (not included)



Step 11: To open lid, use small opening tool included and press into the holes on top of the dispenser.

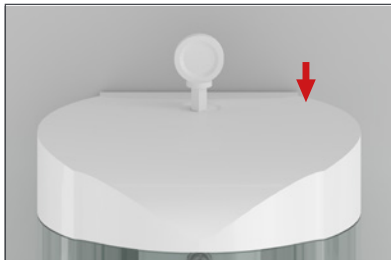

Step 12: Add sanitizer gel to dispenser. Do not overfill.



Step 13: Replace lid.

