

Guttermaster®

"the safe and easy way to clean your gutters"



USER GUIDE

GUTTERMASTER PRO CURVED WATER FED POLE

 604-826-5246

 guttermasterwands@gmail.com

 www.guttermasterwand.com

Thank you!

Thank you very much for your purchase of a Guttermaster Pro Curved Water Fed Pole. This user guide has been prepared to help you get the most out of your purchase. For additional assistance, you can always contact Guttermaster.



604-826-5246



guttermasterwands@gmail.com



www.guttermasterwand.com



The Beginning

*"From the creators of the
Guttermaster Waterfed Poles"*

We are Mike & Lori Wester, creators of the Guttermaster Waterfed Poles. We live in beautiful British Columbia's Fraser Valley surrounded by mountains and lush farmlands. Also known as the Lower Mainland, locals sometimes call it the Lower, "Rainland".

With rain/drizzle falling an average of 174 days per year, Abbotsford has the distinction of being the wettest city in Canada with approximately 1538mm (about 5 feet!) of precipitation falling annually!

As such, it was a dark and stormy evening back in 1994. The rain was pelting and the wind was blowing the remaining fall leaves off the trees. At the time, we lived in a 3-story house on a greenbelt.

Continued on the next page...

Our Story



So when we heard the unmistakable torrent of water gushing from the gutter onto our balcony, we knew what that meant. They were clogged with twigs and leaves from the storm and needed to be cleaned out. But how were we to clean the highest gutters – which were 3 storeys up?

Climbing up a slippery ladder in miserable weather was not an option – especially since our house was built on a slope and it was a very long way down to the bottom. It was then that Mike – always the problem solver – joined a long piece of conduit with a flexible copper pipe (carefully bent to curve on one end), fashioned a nozzle and a hose connector to each end, and attached a garden hose. It looked really weird but... voila! It actually worked! The gutters were flowing freely again and he didn't even have to pull out a ladder!

"The idea for Guttermaster was born."

Over the years, we have researched, developed, and perfected what we think is one of the best – if not the best – gutter cleaning tools on the market. It certainly has come a long way since that first prototype. Our success is a testament to that because we still believe in it. And so do thousands of our happy customers.

"If we can save just one life by keeping people off ladders, we can consider Guttermaster a success."

Mike Wester, Owner/Creator of Guttermaster

Stay Safe and Sound on the Ground...

About the Product

Guttermaster Pro Water Fed Pole

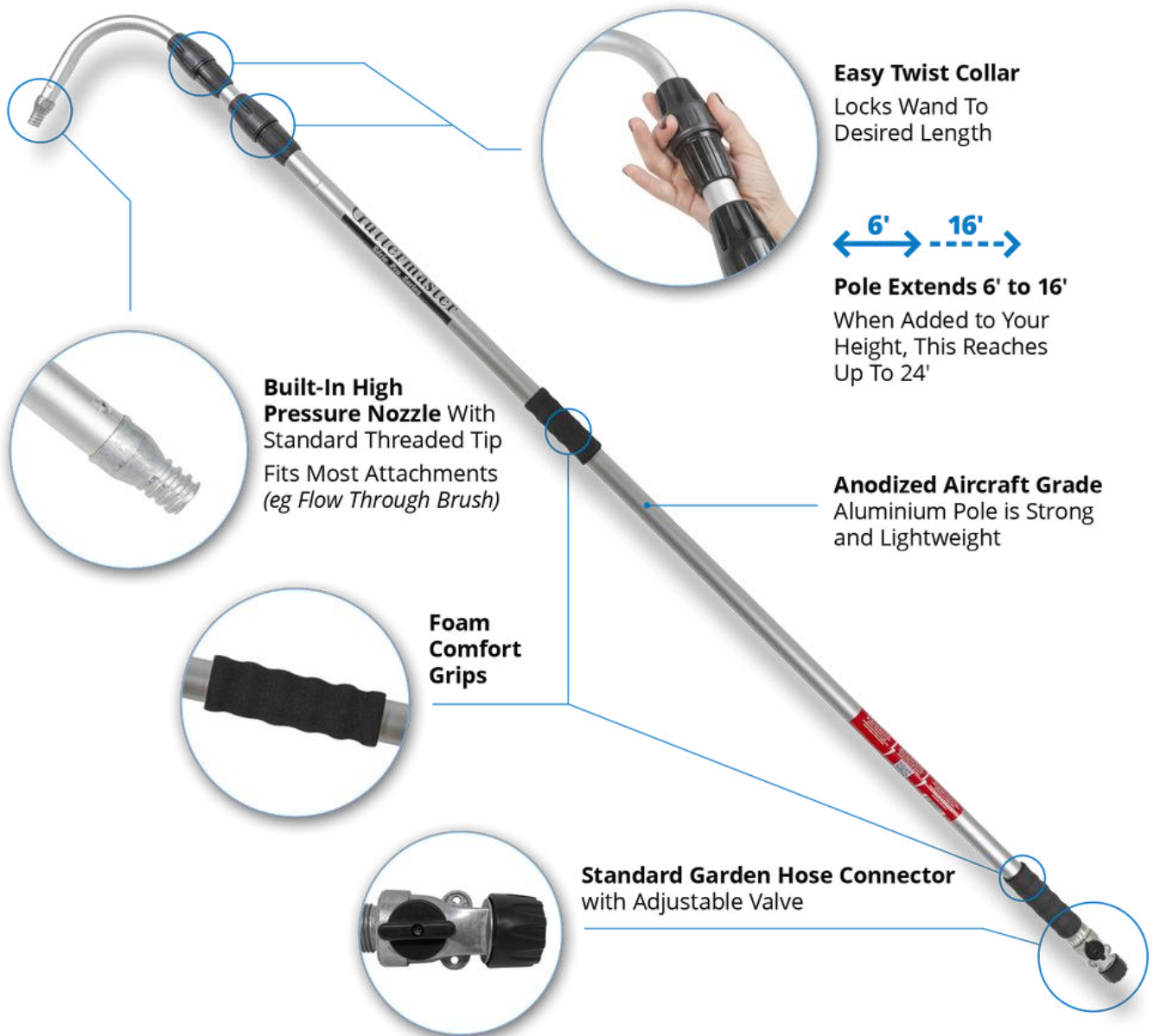

Easy Twist Collar

Locks Wand To Desired Length



Pole Extends 6' to 16'

When Added to Your Height, This Reaches Up To 24'

Built-In High Pressure Nozzle With Standard Threaded Tip Fits Most Attachments (eg Flow Through Brush)

Anodized Aircraft Grade Aluminium Pole is Strong and Lightweight

Foam Comfort Grips

Standard Garden Hose Connector with Adjustable Valve

Specifications

- Extends 6' to 16'; when added to your height it can easily reach second-storey gutters.
- Built-in high-pressure nozzle with standard acme threaded tip for optional accessories.
- Easy twist collar to lock wand to its desired length.
- Comfortable foam grips
- Standard garden hose connector with quarter turn shut-off valve
- Anodized aircraft-grade aluminum pole

About the Product



Clean your own gutters safely from the ground with the Guttermaster Pro Curved Water Pole. Using ladders for cleaning tasks can be very risky and dangerous. Climbing up and down the ladder and stretching over to clean hard-to-reach areas also demands a lot of physical energy. We have the solution! Guttermaster has made cleaning from the ground possible with its curved water-fed pole that is strong yet lightweight and does not compromise on rigidity. The flow-through design makes this tedious seasonal chore quick, safe, and efficient. Clean around your whole house in a single afternoon while saving hundreds of dollars by hiring a professional. Just hook the pole up to your garden hose and you're ready to go!

The force from this telescoping water wand depends entirely on your own garden hose and water pressure, so it can be as strong or gentle as you like. The stronger the pressure, the easier it is to remove years of debris, like clumps of wet pine needles. If you have non-standard gutters we advise contacting your gutter manufacturer for cleaning options.

Note: Depending on your water pressure, there may be some kickback or recoil when using this pole. We recommend acclimating yourself to the pressure gradually before opening the flow control valve fully.

Basic Setup

STAY SAFE AND SOUND ON THE GROUND...



01

There are no accessories or assembly needed for your Guttermaster pole - it is ready to use. The high-pressure nozzle on the tip is permanently attached to the pole.

At the garden hose connection end, you will notice that the metal connector with shut-off is a separate part that unscrews from the pole. This is for easy replacement if it is ever needed.

02

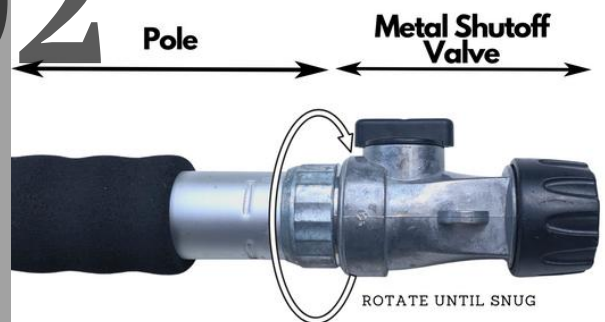

03

Make sure that the shut-off is tight to the pole. This part may have loosened in shipping and it needs to be snug to ensure a good seal.

Basic Setup

STAY SAFE AND SOUND ON THE GROUND...



04

Lastly, make sure there is a rubber washer present where the garden hose connects. This is a standard washer that is the same found in any garden hose or garden hose accessory.

Important

SOME THINGS TO KEEP IN MIND.



Make sure that the shut-off is closed, then attach your garden hose to the pole. Turn on the water flow at the tap. The Guttermaster pole is meant to generate a strong flow of water to push leaves and debris along your gutter, so don't extend it and turn it on full force right away.

With the pole retracted, turn on the water flow slowly and get used to the feel of the pole. Then extend it and get comfortable with usage, still remembering to turn the water on gradually to maintain control.



Those are the basics! You can find some suggestions on the effective use of the Guttermaster pole in the next section. *If you need more detailed information, please scan the QR code.*



Usage Tips

01 Start at the Downspout

For cleaning your gutters, we recommend cleaning small sections at a time for best results. Attach a standard garden hose to the shut-off valve at the base of the extended Guttermaster. Starting at the downspout, point the nozzle directly down into the downspout opening to ensure there are no clogs and ensure water is flowing. Once the nozzle is aimed and in place, slowly turn the water on using the convenient shut-off valve.

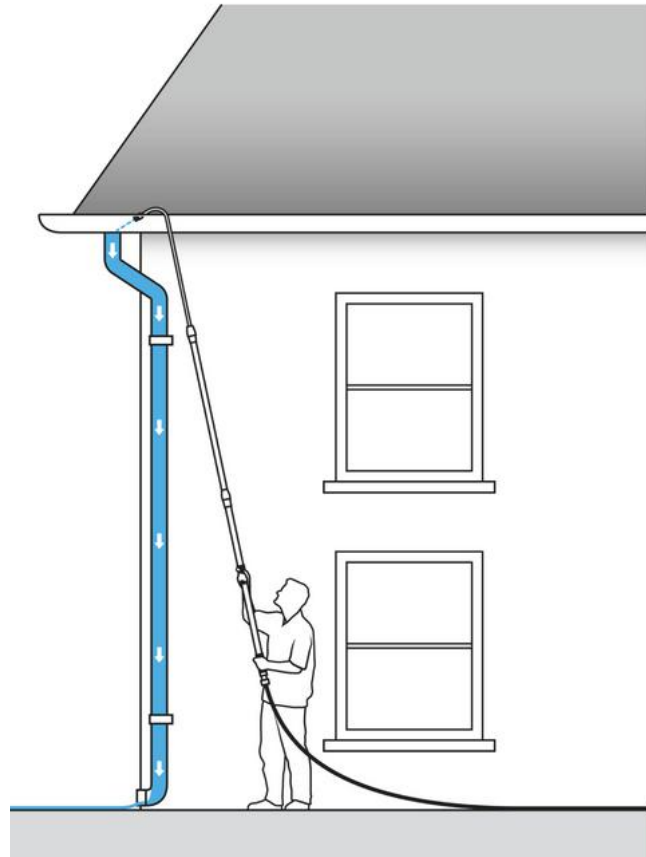

Stand back to one side (and not directly under the gutter) to avoid getting splashed. If the downspout is clogged, you may need to disassemble the downspout to clear the blockage. Once clear, turn the Guttermaster unit off and proceed to step number 2.

02 Move Back from the Downspout

Move the Guttermaster further back from the downspout about 3' to 5'. Stand facing in the direction of the downspout holding the pole at a 10 to 15-degree angle. Ensure you aim the spray head down and along the path of the gutter. Slowly turn on the water, and walk towards the downspout, with the water spraying in the gutter in front of you.

Usage Tips

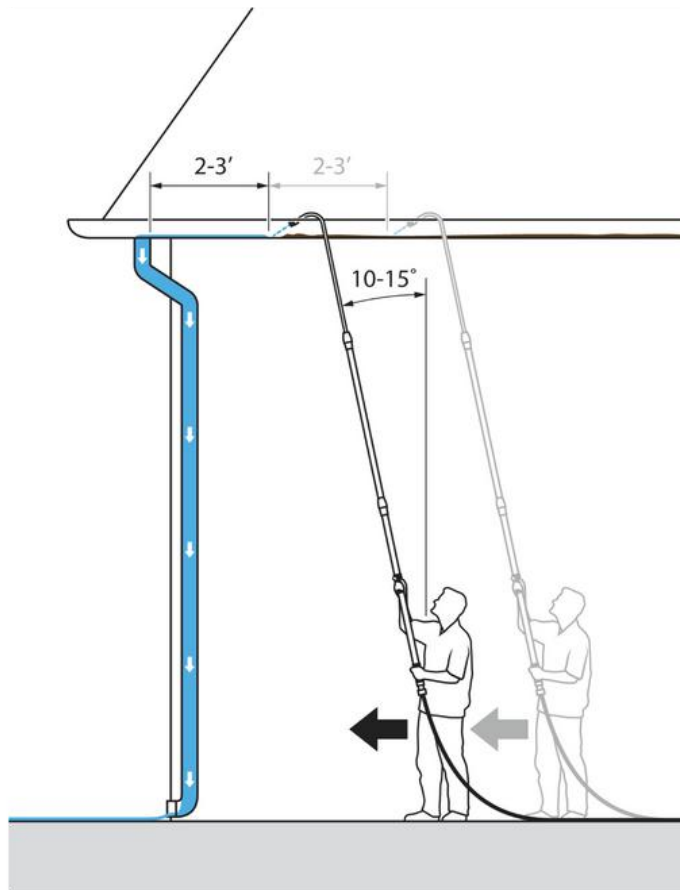

Once you reach the end, if need be, point the nozzle directly downward into the downspout opening to ensure debris is cleared. Turn the unit off. Again, move further back along the gutter another 3' to 5' and repeat these simple steps until you have cleaned the entire length of the gutter.

Please Note: Do not pull the garden hose along using the Guttermaster pole. It is recommended to leave plenty of slack in the hose while in use. To move to another area, pull the hose with one hand while carrying the Guttermaster in the other.

Best results will occur with regular maintenance of your gutters. The less the debris builds up, the quicker the cleaning time. If the gutter has been neglected for some time and is full of large twigs and fresh leaves, you may need to use the tip of the Guttermaster to try to flip the large pieces out of the gutter. Optional water flow brushes can be used with the Guttermaster pole for cleaning windows, siding, vehicles, and more. To clean surfaces, attach the appropriate brush for the task and

slowly turn on the valve to soak the surface and loosen the dirt. Turn the water off and apply cleaning solutions if needed. Rinse and repeat if necessary.

Note: Do not overtighten the brush as it may strip the threads inside the brush head. If you need to realign the brush, turn it counterclockwise and back it off until the desired position is achieved..

Troubleshooting

What to watch out when problems occur?

Your Guttermaster Curved Pole has a removable shutoff valve for easy maintenance. This is a standard-size garden hose shutoff. Please note that it unscrews from the body of the pole. There are 2 washers that need to be present for leak-free operation.

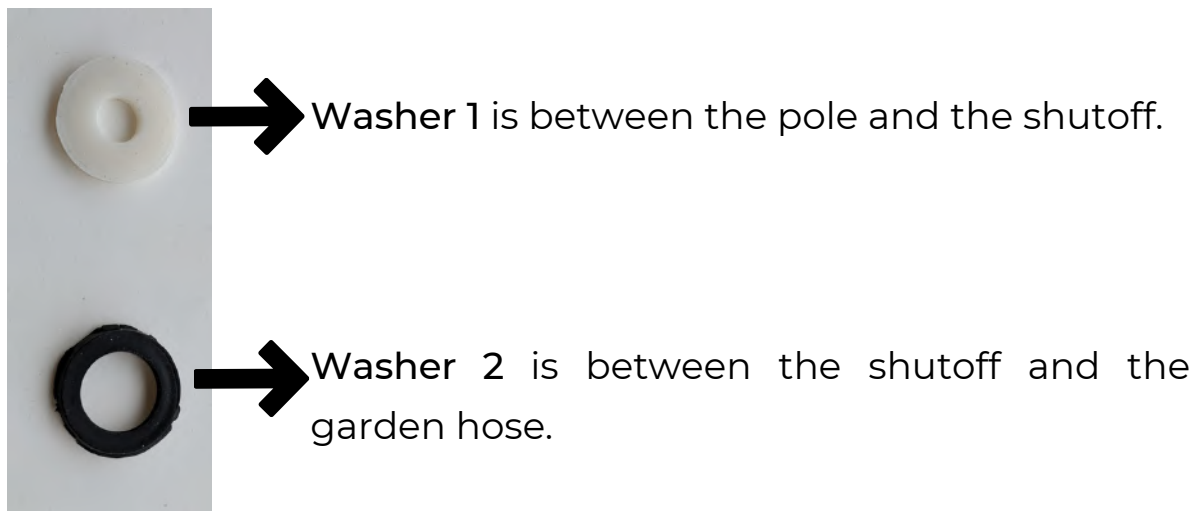

First, make sure that the white washer is present between the shutoff and the pole. This shutoff can loosen during shipment or if the pole is overly twisted during use, so make sure that it is twisted just snug.

Note: Do not overtighten this connector.

Next, make sure that the black washer is present between the shutoff and your hose. Make sure this connection is tight and snug but again do not overtighten.

Troubleshooting _____

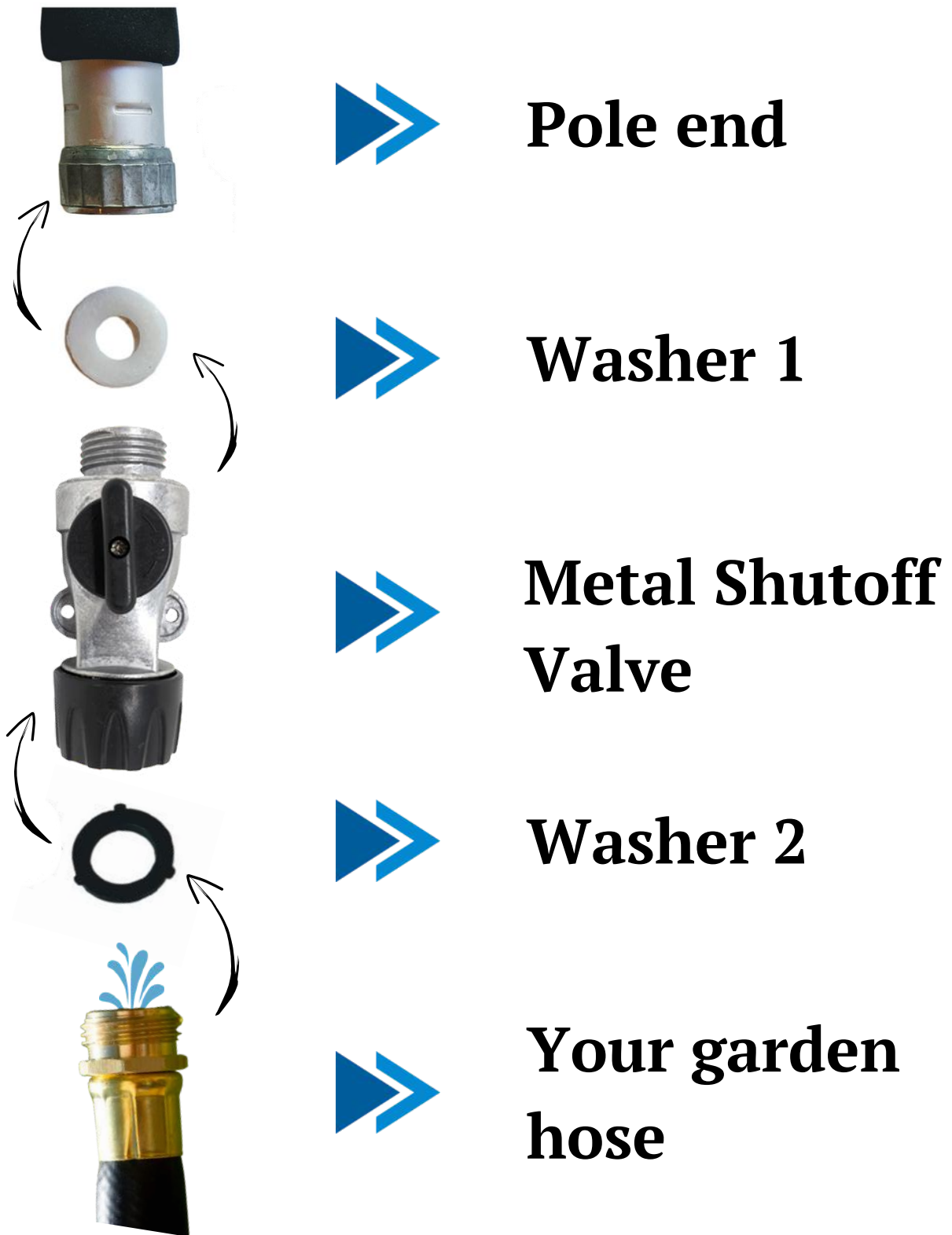

If you need further assistance, please contact us directly and we will be happy to help.

Our Family of Guttermaster® Wands



Guttermaster Curved Pole

5-12' waterfed pole with curved end



Guttermaster Pro Pole

6-16' waterfed pole with curved end



Guttermaster Straight Pole

5-12' waterfed pole with straight end



Guttermaster Mini Pole

3-6' waterfed pole with straight end

The Right Brush for Every Job!



Transform your Guttermaster Wand into a versatile cleaning tool for gutters, windows, vinyl siding, RVs, boats, cars, and trucks!



Guttermaster **Green** Oblong Brush

Very Soft. Use for easily scratched surfaces, like awnings and fiberglass.



Guttermaster **Blue** Oblong Brush

Medium-Soft Use for RVs, trucks, campers, windows, vinyl siding, boats, rims, wheels, detailing

The Right Brush for Every Job!



Guttermaster Gray Oblong Brush

Medium Stiff. Use for hardwood decks, cement sidewalks, asphalt driveways, brick patios



Guttermaster Blue Rubberized-Edge Brush

Medium-Soft Use for RVs, trucks, campers, windows, vinyl siding, boats, rims, wheels, detailing



Guttermaster Blue Round Brush

Medium-Soft Use for RVs, trucks, campers, windows, vinyl siding, boats, rims, wheels, detailing



Guttermaster Gray Round Brush

Medium-Stiff. Use for hardwood decks, cement sidewalks, asphalt driveways, and brick patios.



Guttermaster Blue Handheld Brush

Medium-Soft Use for RVs, trucks, campers, windows, vinyl siding, boats, rims, wheels, detailing

Guttermaster Flower Shower

Introducing the newest member of the Guttermaster Family...our "Flower Shower" gentle spray nozzle attachment!



If you're having a little trouble reaching those high flower baskets, window boxes, or even those flowers way back in the garden... then we have the answer!

It's so easy to use!

Simply connect your garden hose up to our extendable Guttermaster Curved or Pro Pole (sold separately) and attach the "Flower Shower" nozzle by pushing it firmly onto the tip of the wand.

- Gentle Spray Action
- Easily Adaptable to All Guttermaster Wands

Available only on:

Amazon.ca



Amazon.com



