

Guttermaster Curved Water Fed Pole User Guide

Thank you very much for your purchase of a Guttermaster Curved Water Fed Pole. This user guide has been prepared to help you get the most out of your purchase.

For additional assistance, you can always contact Guttermaster at www.guttermasterwand.com via phone or email.

Phone ☎: 604.826.5246

Email ✉: guttermasterwands@gmail.com

Specifications

- Extends 5' to 12' with a reach of up to 20' and more using the "easy twist" collar. Reaches 2nd story gutters on most homes.
- Built in high pressure nozzle with standard acme threaded tip for optional accessories
- Comfortable foam grips
- Standard garden hose connector with quarter turn shut-off valve
- Anodized aircraft grade aluminum pole
- 2 year limited warranty

About the Product

Clean your own gutters safely from the ground with the Guttermaster Classic Curved Water Pole. Using ladders for cleaning tasks can be very risky and dangerous. Climbing up and down the ladder and stretching over to clean hard to reach areas also demands a lot of physical energy. We have the solution! Guttermaster has made cleaning from the ground possible with its curved water fed pole that is strong yet lightweight and does not compromise on rigidity. The flow through design makes this tedious seasonal chore quick, safe and efficient. Clean around your whole house in a single afternoon while saving hundreds of dollars hiring a professional. Just hook the pole up to your garden hose and you're ready to go!

The force from this telescoping water wand depends entirely on your own garden hose and water pressure, so it can be as strong or gentle as you like. The stronger the pressure, the easier it is to remove years of debris, like clumps of wet pine needles. If you have non-standard gutters we advise contacting your gutter manufacturer for cleaning options.

Note: *Depending on your water pressure, there may be some kickback or recoil when using this pole. We recommend acclimating yourself to the pressure gradually before opening the flow control valve fully.*

Guttermaster CLASSIC CURVED WATERFED GUTTER CLEANING POLE



Setup

There are no accessories or assembly needed for your Guttermaster pole - it is ready to use. The high pressure nozzle on the tip is permanently attached to the pole.

At the garden hose connection end you will notice that the plastic connector with shut-off is a separate part that unscrews from the pole. This is for easy replacement if it is ever needed. Make sure that the shut-off is tight to the pole. This part may have loosened in shipping and it needs to be snug to ensure a good seal.

Lastly, make sure there is a rubber washer present where the garden hose connects. This is a standard washer that is the same found in any garden hose or garden hose accessory. You can find replacements at any hardware store or even most dollar stores, but if you are missing this washer please contact us at www.Guttermasterwand.com for assistance. This washer is also needed to make sure you have a watertight seal at this connection.



Make sure that the shut-off is closed, then attach your garden hose to the pole. Turn on the water flow at the tap. The Guttermaster pole is meant to generate a strong flow of water to push leaves and debris along your gutter, so don't extend it and turn it on full force right away. With the pole retracted, turn on the water flow slowly and get used to the feel of the pole. Then extend it and get comfortable with usage, still remembering to turn the water on gradually to maintain control.

Those are the basics! You can find some suggestions on effective use of the Guttermaster pole in the next section.

Usage Tips

Step 1: For cleaning your gutters, we recommend cleaning small sections at a time for best results. Attach a standard garden hose to the shut-off valve at the base of the extended Guttermaster. Starting at the downspout, point nozzle directly down into the downspout opening to ensure there are no clogs and ensure water is flowing. Once the nozzle is aimed and in place, slowly turn the water on using the convenient shut-off valve. Stand back to one side (and not directly under the gutter) to avoid getting splashed. If the downspout is clogged, you may need to disassemble the downspout to clear the blockage. Once clear, turn the Guttermaster unit off and proceed to step number 2.

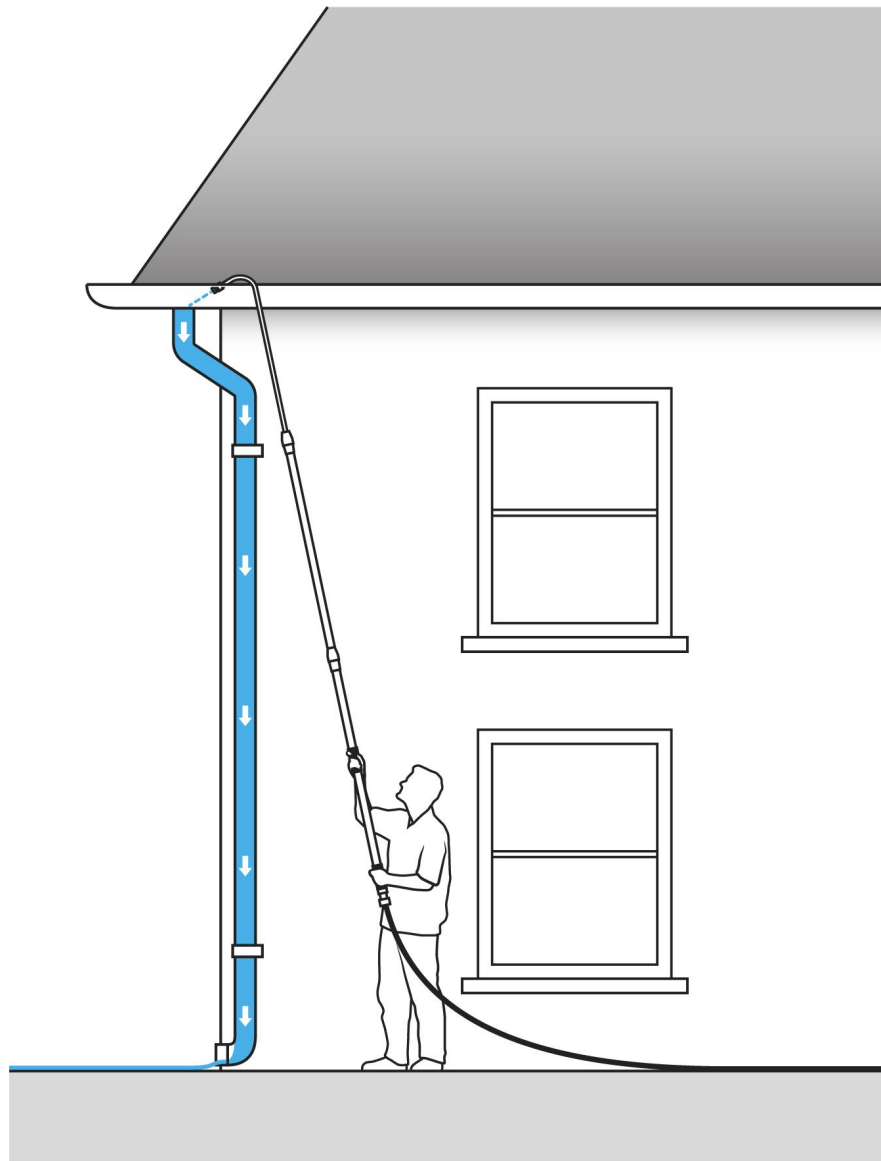

Step 2: Move the Guttermaster further back from the downspout about 3' to 5'. Stand facing in the direction of the downspout holding the pole at a 10 to 15 degree angle. Ensure you aim the spray head down and along the path of the gutter. Slowly turn on the water, and walk towards the downspout, with the water spraying in the gutter in front of you. Once you reach the end, if need be, point the nozzle directly downward into the downspout opening to ensure debris is cleared. Turn the unit off. Again, move further back along the gutter another 3' to 5' and repeat these simple steps until you have cleaned the entire length of the gutter.

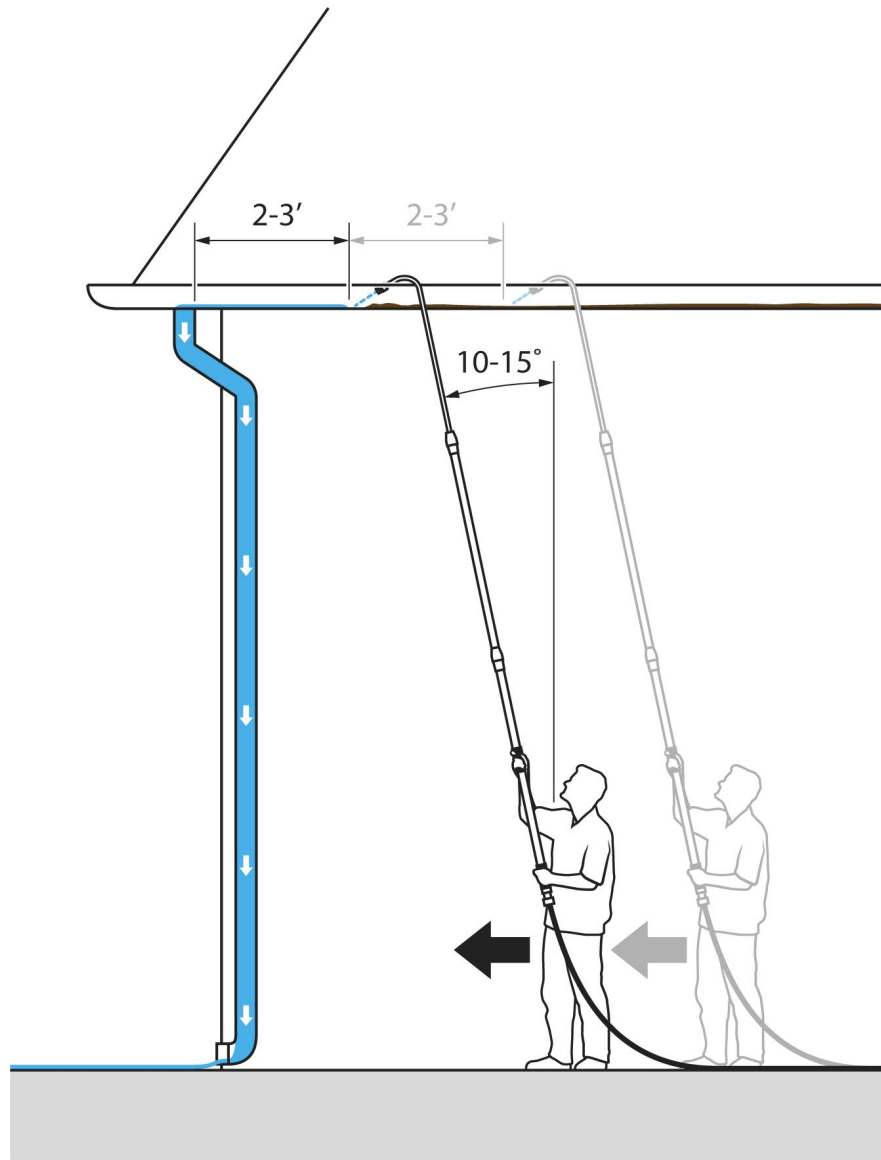

Please Note: Do not pull the garden hose along using the Guttermaster pole. It is recommended to leave plenty of slack in the hose while in use. To move to another area, pull the hose with one hand, while carrying the Guttermaster in the other.

Best results will occur with regular maintenance of your gutters. The less the debris builds up, the quicker the cleaning time. If the gutter has been neglected for some time and is full of large twigs and fresh leaves, you may need to use the tip of the Guttermaster to try to flip the large pieces out of the gutter.

Optional waterflow brushes can be used with the Guttermaster pole for cleaning windows, siding, vehicles, and more. To clean surfaces, attach the appropriate brush for the task and slowly turn on the valve to soak the surface and to loosen the dirt. Turn the water off and apply cleaning solutions if needed. Rinse and repeat if necessary.

Note: Do not overtighten the brush as it may strip the threads inside the brush head. If you need to realign the brush, turn it counterclockwise and back it off until desired position is achieved.

Want to use a brush and pole to clean your windows?

- 1) Attach your garden hose and brush to the Guttermaster wand, making sure the shutoff valve at the base of the wand is in the "off" position. Turn water on at the tap.
- 2) Fill a large bucket with 8 liters of hot water and add a half tablespoon each of Dawn Dishwashing Liquid™ and liquid Jet Dry™. Apply this soap solution to windows using your Guttermaster wand/brush.
- 3) Slowly turn the water on with the shutoff valve to completely rinse off the soap. Allow to air dry. Your windows will be sparkling!

Please see a product demonstration video at the link below:

<https://youtu.be/UBAFjkSc0qg>



Troubleshooting

Your Guttermaster Curved Pole has a removable shutoff valve for easy maintenance. This is a standard size garden hose shutoff. Please note that it unscrews from the body of the pole. There are 2 washers that need to be present for leak free operation.

Washer 1 is between the pole and the shutoff.

Washer 2 is between the shutoff and the garden hose.



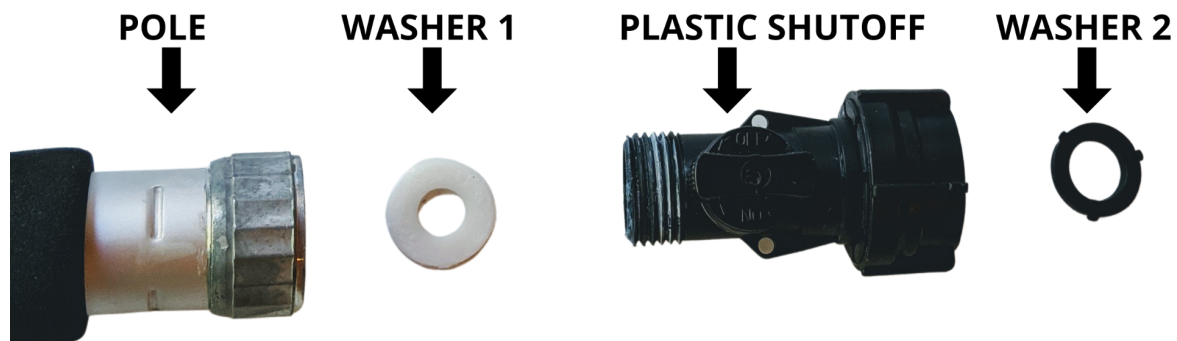

First, make sure that the white washer is present between the shutoff and the pole. This shutoff can loosen during shipment or if the pole is overly twisted during use, so make sure that it is twisted just snug. **Note: Do not overtighten this connector.**

Next, make sure that the black washer is present between the shutoff and your hose. Make sure this connection is tight and snug but again do not overtighten.

If you need further assistance, please contact us directly and we will be happy to help.



Guttermaster Products

	<p>Guttermaster Curved Pole</p>	<p>5-12' waterfed pole with curved end</p>
	<p>Guttermaster Pro Pole</p>	<p>6-16' waterfed pole with curved end</p>
	<p>Guttermaster Straight Pole</p>	<p>5-12' waterfed pole with straight end</p>
	<p>Guttermaster Mini Pole</p>	<p>3-6' waterfed pole with straight end</p>

	<p>Guttermaster Green Oblong Brush</p>	<p>Softest brush For vehicles and boats</p>
	<p>Guttermaster Blue Oblong Brush</p>	<p>Medium soft brush For larger vehicles, house siding and windows</p>
	<p>Guttermaster Gray Oblong Brush</p>	<p>Coarse brush For tougher jobs like decks, sidewalks, algae and moss removal</p>
	<p>Guttermaster Blue Round Brush</p>	<p>Medium soft brush For wheels and tighter areas</p>
	<p>Guttermaster Gray Round Brush</p>	<p>Coarse brush For tougher cleaning jobs</p>