

## 1995 AND 1996 S2/S2T SADDLEBAG CONVERSION KIT

### General

This kit is designed for installation of S3 Saddlebag Kits on 1995 and 1996 Buell S2 and S2T Model Motorcycles. The saddlebags come with barrel-style locks and removable liners.

#### NOTE

The Saddlebag Kits can be ordered in either Deep or Narrow Styles and painted to match the color of your bike. Refer to the Saddlebag Kit Ordering Detail Part Numbers at the bottom of Page 8 for details.

See Service Parts Page Illustrations for kit contents.

#### ⚠ WARNING

Keep cargo weight concentrated close to the motorcycle and as low as possible to minimize the change in the motorcycle's center of gravity. Distribute weight evenly on both sides of the vehicle and do not load bulky items too far behind the rider or add weight to the handlebars or front forks. Do not load saddlebag beyond maximum weight capacity. See label inside saddlebag for weight capacity limit. Improper loading can adversely affect handling, leading to death or serious injury.

#### ⚠ WARNING

The rider's safety depends on the correct installation of this kit. If the following installation procedures are not within your capabilities, or if you do not have the correct tools, have your Buell dealer perform this installation. Failure to do the installation correctly could result in death or serious injury.

#### NOTE

A Service Manual for your motorcycle is available from your Buell Dealer.

### Installation

#### ⚠ WARNING

To protect against shock and accidental start-up of vehicle, disconnect the negative battery cable before proceeding. Inadequate safety precautions could result in death or serious injury.

#### ⚠ WARNING

Always disconnect the negative battery cable first. If the positive cable should contact ground with the negative cable installed, the resulting sparks may cause a battery explosion which could result in death or serious injury.

1. Disconnect battery cables, negative cable first.
2. Follow instructions in applicable Service Manual and remove seat.

3. Follow instructions in applicable Service Manual and remove fuel tank cover. Save hardware for re-installation.
4. Disconnect tail lamp connector under tail section. Cut wire ties securing the tail lamp connector harness along the left frame rail.
5. Follow instructions in applicable Service Manual to remove tail section and place section on bench or similar work area. Save mounting hardware for re-installation.
6. **S2T Models only:** Follow instructions in applicable Service Manual and remove existing saddlebag mounting bracket from frame. Discard mounting bracket and hardware.
7. See Figure 2. Following instructions in applicable Service Manual, remove the left and right passenger footpeg assemblies, however leave mounting screws (studs) in place within the frame mounts. Save footpegs for re-installation.
8. Obtain new saddlebag mounting bracket (Part Number L1025.8) from kit. Perform the following:
  - a. See Figure 1. Place front portion of saddlebag mounting bracket in position above tail section frame mounts as shown.

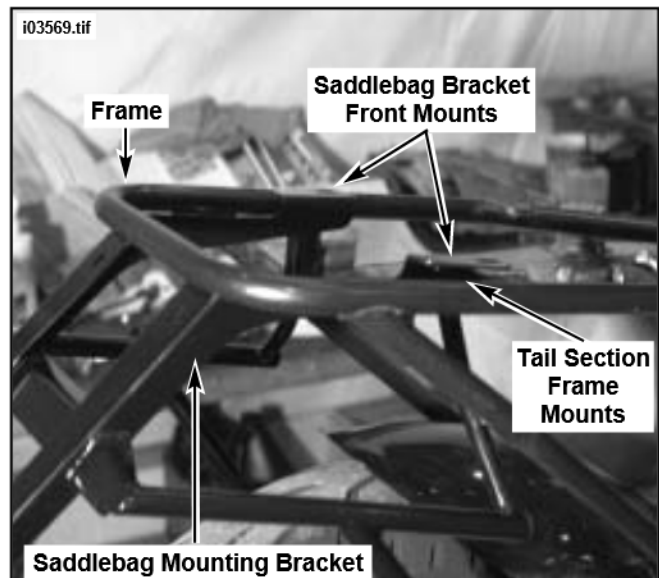
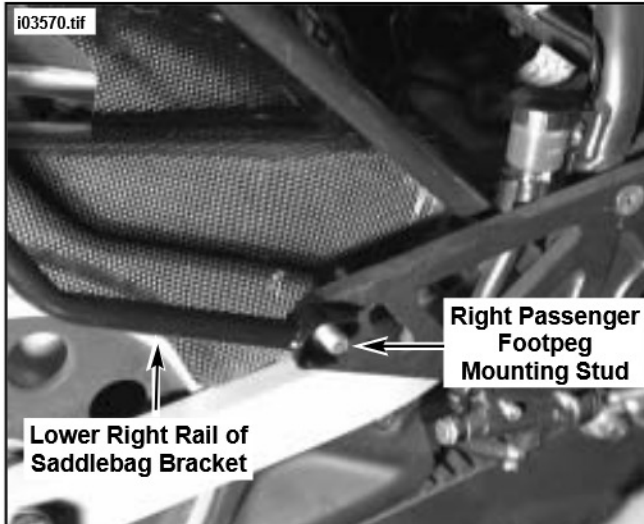

Figure 1. Position Front Upper Portion of Saddlebag Mounting Bracket

- b. See Figure 2. Place the left and right lower rails of the mounting bracket over the respective left and right footpeg studs.

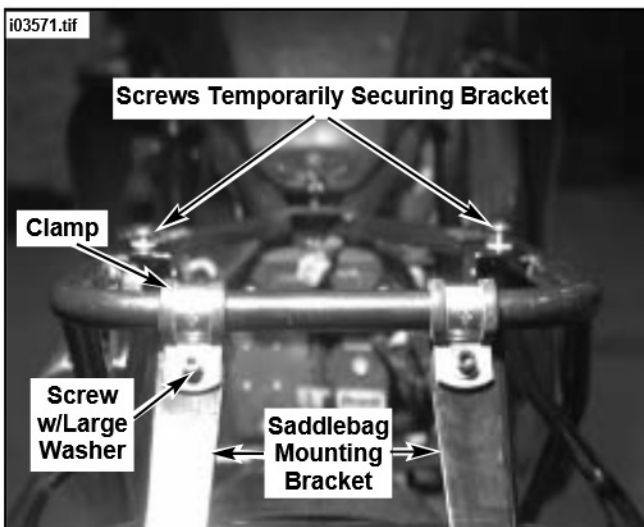

**Figure 2. Place Lower Mounting Bracket Rails onto Footpeg studs (Right Side Shown)**

- c. See Figure 3. Obtain two of the screws used to secure the tail section to frame (removed in Step 4), and temporarily secure (partially thread screws) the front portion of the saddlebag bracket to the frame as shown. This will keep the mounting bracket aligned during installation.
- d. Obtain the two 3/4 inch clamps (Part Number O0650.8) from kit. Wrap clamps around rear frame rail and secure saddlebag mounting bracket to frame as shown using Screws (Part Number AA0406.2CBL), Washers (Part Number BA0409.1Z), Washers (Part Number B0613.1Z) and lock nuts (Part Number DA0400.10CZ) from kit. Make sure mounting bracket is aligned and tighten clamp hardware securely. Remove partially threaded screws temporarily holding bracket in place.

**NOTE**

*The large washers are installed under the bolthead and the small washers are installed under the nut.*

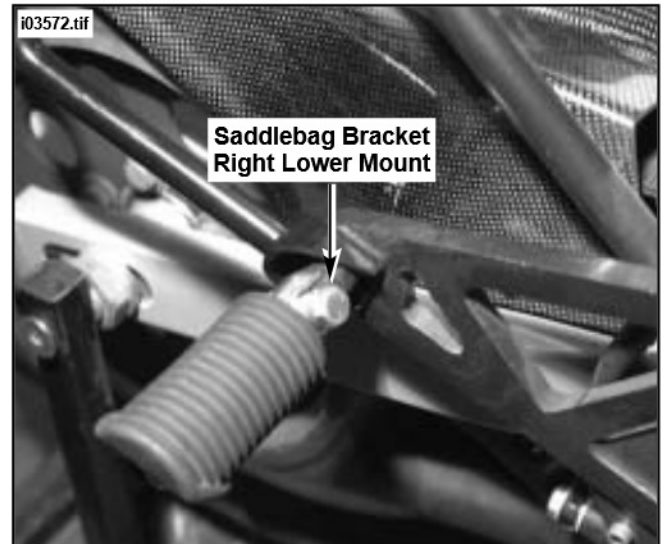

**Figure 3. Install Clamps To Secure Mounting Bracket to Frame (Rear View)**

**WARNING**

Footpegs must fold up at 45° angle (from verticle) toward rear of motorcycle. This angle allows footpeg to fold up if it strikes the ground when making a sharp turn. Failure to set footpeg to the proper fold-up angle could result in death or serious injury.

- e. See Figure 4. Obtain right footpeg assembly removed in Step 6. Place a few drops of Loctite (Red) to stud threads and thread footpeg assembly onto stud, over saddlebag bracket lower mounting rail. Tighten assembly to 18-20 ft-lbs (24-27 Nm). Repeat Step for the left footpeg assembly.



**Figure 4. Re-install Passenger Footpegs (Right Shown)**

- 9. See Figure 5. Obtain the two Rubber Sleeves (Boots) (Part Number C3012.E) and two Saddlebag Bumpers (with Bolts Part Number C3011.EA) and Jam Nuts (Part Number DA0400.4CZ) from kit. Slide the sleeves onto the saddlebag bracket rail tips, then thread jam nut onto the bumper and install bumpers into each end of rail.

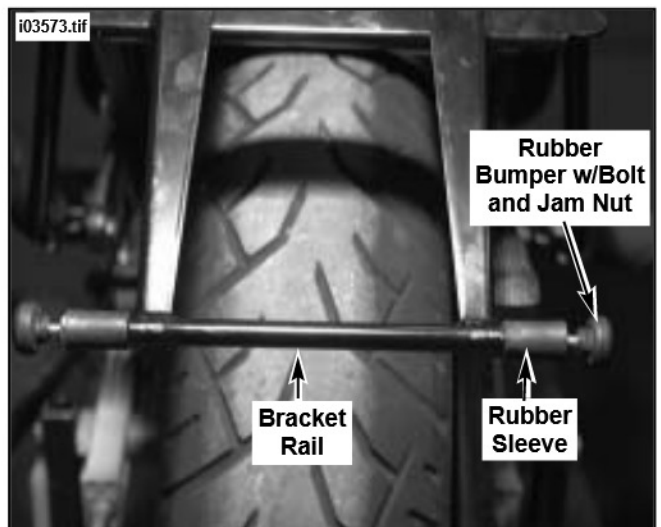

**Figure 5. Install Rubber Sleeves and Bumpers**

10. See Figure 6. Position tail section upside down (on soft cloth to prevent damage) and perform the following:
  - a. Locate and disconnect the left and right turn signal connectors.
  - b. Remove the mounting nut and washer (if present) securing the left turn signal assembly to the license plate bracket. Discard nut and washer
  - c. Remove turn signal and pull wiring through license plate bracket. Repeat Steps b and c for the right turn signal. Discard Turn Signals.
  - d. Thoroughly clean the turn signal mounting areas on both sides of fender of dirt and deteriorating rubber. Also clean up remaining wiring and connectors (especially areas of electrical contact).

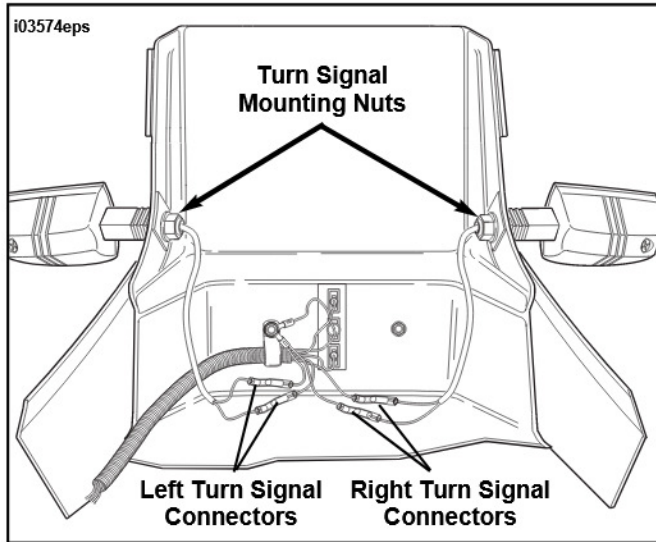

Figure 6. Remove Existing Turn Signal Assemblies

11. For **S2T models** (with existing saddlebags), proceed to Step 12. For **S2 Models** (without existing saddlebags), holes will have to be drilled in the license plate bracket to relocate the turn signals. Remove license plate, if present, from license plate bracket and perform Steps a through h.
  - a. Obtain the Drill Template located on the last page of this instruction sheet. Use scissors and cut sections marked **RIGHT** and **LEFT** from template.
  - b. Fold template sections marked **A** and **B** at areas indicated by broken lines.
  - c. See Figure 7. Position and tape the template marked "**RIGHT**" over right side of license plate bracket with template oriented as shown.
  - d. Use a punch and gently tap a drill starting mark at the center of each of the circles (marked by crosshairs) into the license plate bracket.

**NOTE**

*A Step Drill is recommended for use in the following Steps to prevent tearing or ripping when drilling fiberglass.*

- e. See Figure 8. Using a 1/2 .inch bit, carefully drill the larger hole into the license plate bracket at area marked in previous Step.
- f. Using a 5/32 inch bit, carefully drill the smaller hole into the license plate bracket at area marked in Step d.
- g. Repeat Steps a through f for the left side of the license plate bracket using the template marked "**LEFT**".

- h. Clean the drilled areas of shavings and smooth out any sharp areas. Proceed to Step 12.

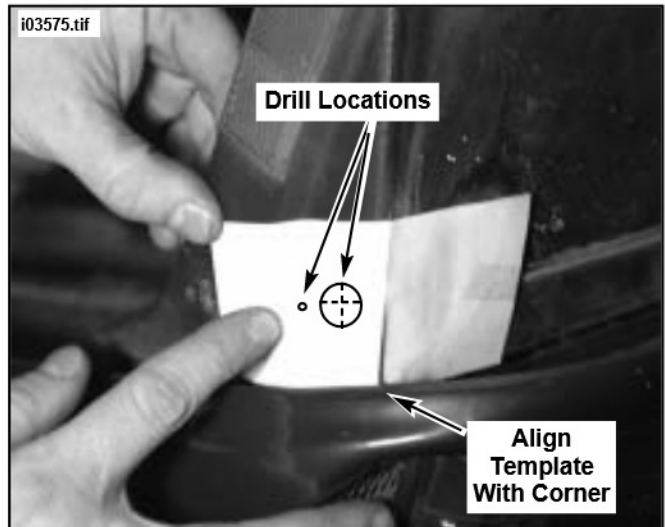

Figure 7. Proper Drill Template Orientation

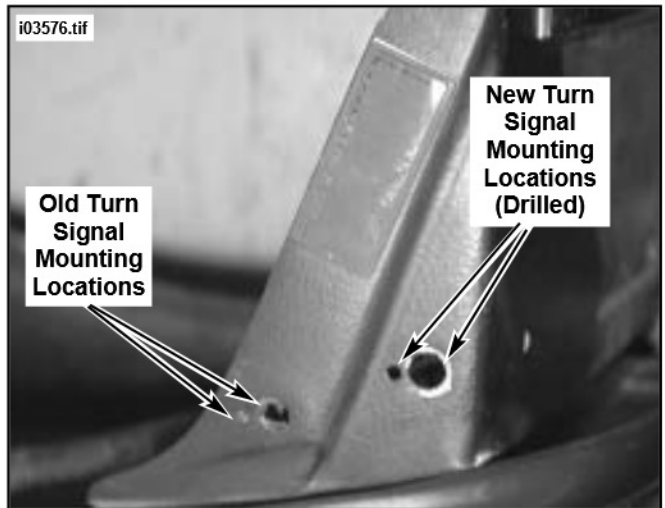

Figure 8. New Turn Signal Mounting Locations

12. See Figure 9. Obtain Wellnut (Part Number M0707.3) from kit. Thread 1/4 inch screw (Part Number AA0406.3CBL) into wellnut to temporarily aid in installation and install wellnut to new hole in license plate bracket as shown. Remove screw and repeat for the opposite side.

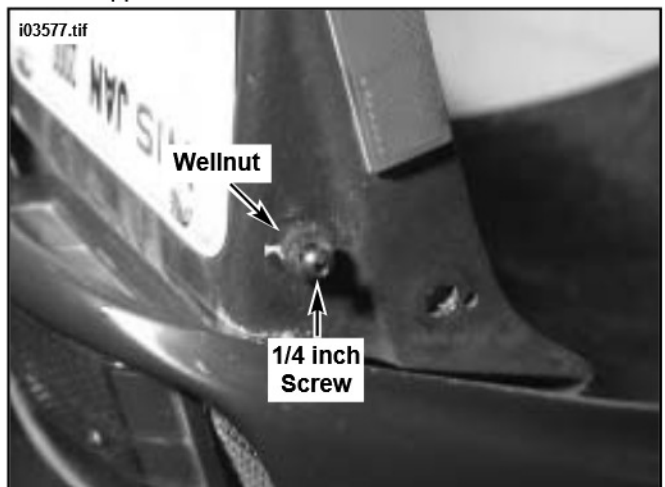

Figure 9. Install Rubber Wellnuts

13. The left and right turn signals will need to be assembled prior to installation. Perform Steps a through f to assemble turn signals.
  - a. Obtain the Left Turn Signal Housing (Part Number Y0504.9), Left Turn Signal Mounting Bracket (Part Number M0624.8), Countersunk Screw (Part Number AN1005.5FSS) and Nylock Nut (Part Number DN1000.2FZ) from kit.

**NOTE**

*The Left and Right Turn Signals and Turn Signal Brackets appear identical, but are not. The turn signals can be identified by holding each turn signal in position as it will be mounted with the drain hole in assembly oriented downward. When orienting the bracket in Steps b and e, make sure the countersunk side of the bracket is facing outward and the screw will actually be "countersunk" when installed.*

- b. See Figure 10. Thread turn signal wires through hole in long portion of left bracket. Orient bracket as shown and secure to turn signal housing using countersunk screw and nylock nut. Tighten securely.
- c. Obtain Left Turn Signal Wire Extensions-Purple (Part Number YH002.B) and Black Wire (Part Number YH003.B) from kit and connect to wires exiting left turn signal housing.
- d. Obtain Right Turn Signal Housing (Part Number Y0503.9), Right Turn Signal Mounting Bracket (Part Number M0623.8), Countersunk Screw (Part Number AN1005.5FSS) and Nylock Nut (Part Number DN1000.2FZ) from kit.
- e. Thread turn signal wires through hole in long portion of right bracket. Orient bracket as shown and secure to turn signal housing using countersunk screw. Tighten securely.
- f. Obtain Right Turn Signal Wire Extensions-Brown (Part Number YH001.B) and Black (Part Number YH003.B) and connect to wires exiting right turn signal housing.

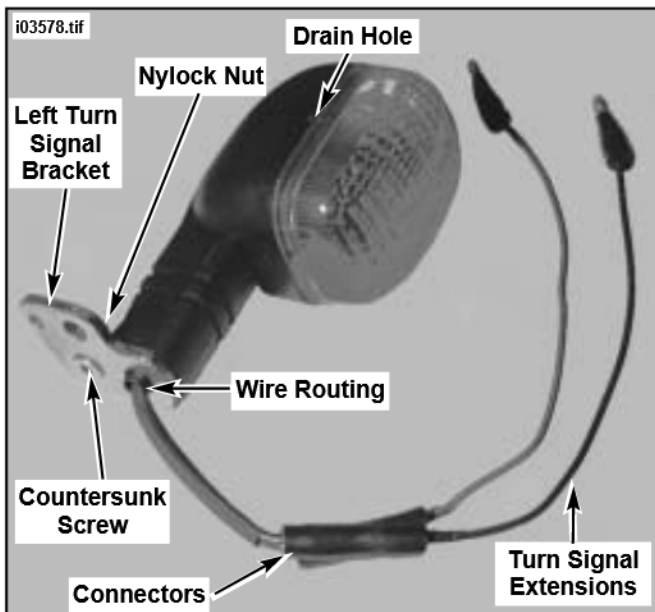

**Figure 10. Pre-assemble Turn Signals (Left Turn Signal Shown)**

14. See Outer and Inner views of license plate bracket in Figure 11. Obtain 1/4x20x3/4 inch Button Head Screw (Part Number AA0406.3CBL) and 8-32x3/4 Button Head Screw (Part Number AN0806.3CBL), from kit. Install turn signal to license plate bracket with the 1/4x20x3/4 inch screw through turn signal bracket and into wellnut (installed in earlier step). Leave loose, do not tighten fully at this time.
15. Install the 8-32x3/4 inch screw through bracket, through plastic washer (Part Number M0603.4), then through license plate bracket and into nut (Part Number DN0800.1CZ). Tighten securely. Return to screw installed to well-nut in previous step and tighten securely.
16. Route turn signal wiring through old turn signal mounting hole as shown.
17. Repeat Steps 14 through 16 for the opposite turn signal. Tighten hardware securely.

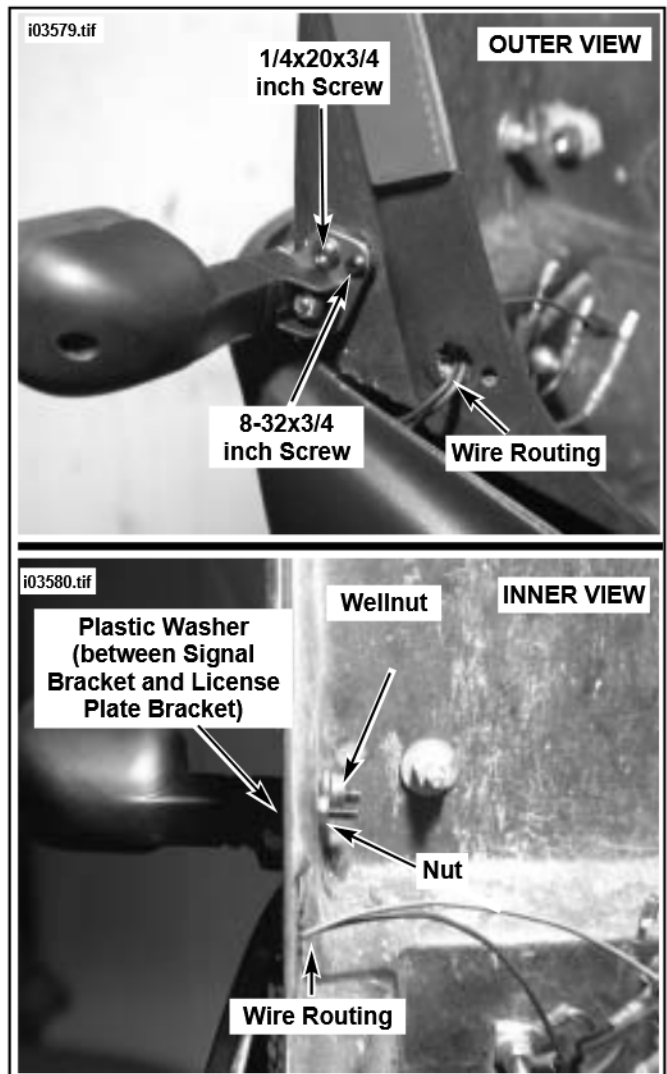

**Figure 11. Turn Signal Installation (Left Side Shown)**

18. See Figure 12. Connect the left and right turn signal connectors near center of tail section. Use wire tie (Part Number Y0305.8B) and secure as bundle to hold wiring in place. Cut off any excess wire tie.

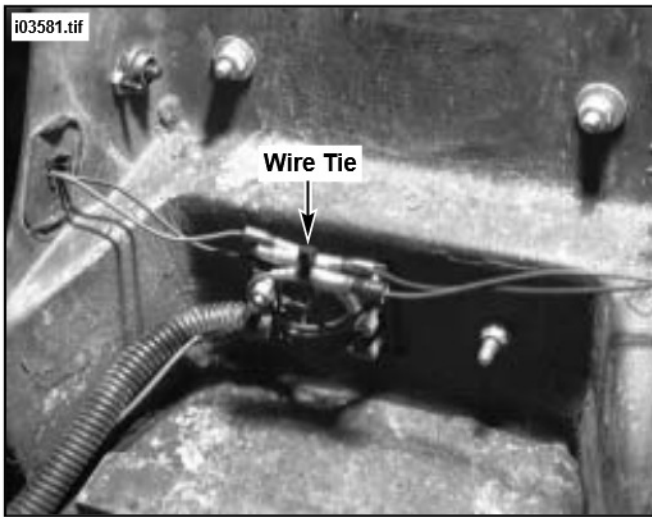

**Figure 12. Connect Turn Signal Wiring**

19. Position tail section on motorcycle frame. Connect rear tail lamp harness connector. Use wire ties (Part Number Y0303.2B) and secure harness along the left upper frame rail.
20. Follow instructions in applicable Service Manual and install tail section.
21. Follow instructions in applicable Service Manual and install fuel tank cover.

**⚠ WARNING**

Always connect the positive battery cable first. If the positive cable should contact ground with the negative cable installed, the resulting sparks may cause a battery explosion resulting in death or serious injury.

22. Connect negative battery cable.
23. Follow instructions in applicable Service Manual and install seat.

**⚠ WARNING**

After installing seat, pull upward on front of seat to be sure it is locked in position. If seat is loose, it could shift during vehicle operation causing loss of control of vehicle and death or serious injury.

**Saddlebag Installation**

24. See Figure 13. Align the molded channels on rear of saddlebag with support brackets.

**CAUTION**

Make sure saddlebag is fully seated on bracket. Failure to do so could result in saddlebags becoming detached and/or damaged.

25. Attach saddlebags to brackets by turning the three fasteners 1/4 turn to the rear. Handles will be parallel to molded channels inside saddlebag. Gently push fastener handles closed, but do not force. Hook retention cable to retention knob on cover as shown in Figure 16.

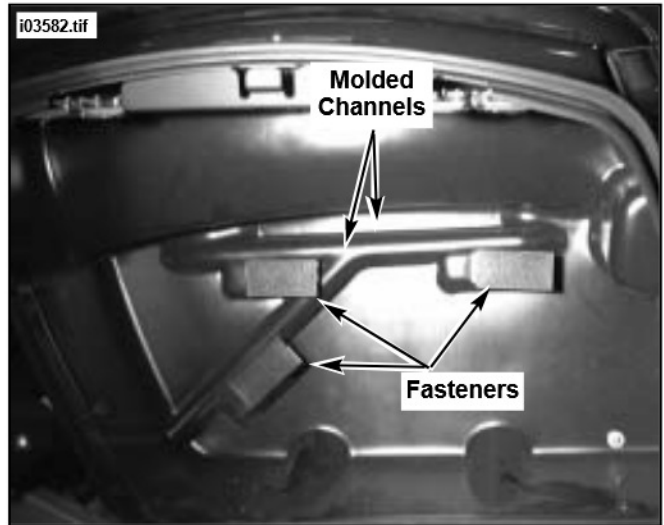

**Figure 13. Install Saddlebags**

26. See Figure 14. Install saddlebag liner. Close cover by aligning hooks on saddlebag cover with openings on saddlebag body and firmly push inward. Do not force saddlebag covers closed.

**CAUTION**

Make sure contents do not interfere with cover seal when closing. If seal is disturbed, bags will not close properly.



**Figure 14. Install Saddlebag Liner**

27. Lock saddlebag and remove key.
28. If saddlebags are difficult to close or install, check rear saddlebag bracket alignment on both sides. Refer to the Saddlebag Alignment in the next section.

**Saddlebag Alignment**

**NOTE**

Prior to performing alignment make sure saddlebags are fully secured to the mounting brackets.

29. See Figure 15. Slide rubber boot away from bumper assembly.
30. Turn bumper counterclockwise until it contacts saddlebag.

31. Turn bumper one additional full turn counterclockwise.
32. Tighten jam nut against rear saddlebag support bracket.
33. Slide rubber boot over bumper assembly.

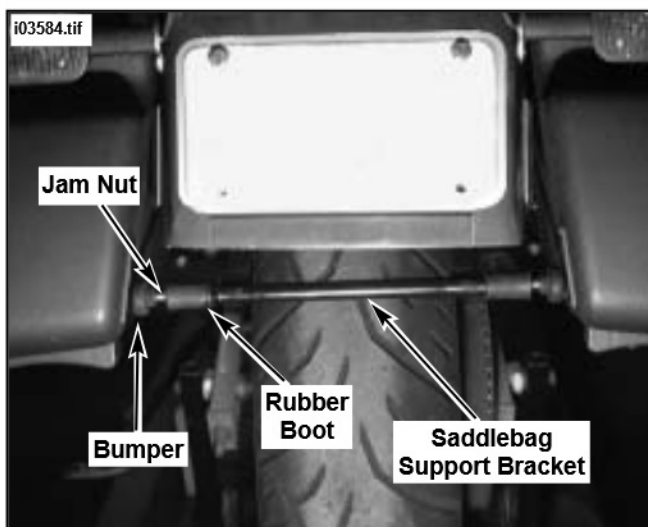

Figure 15 Perform Saddlebag Alignment

## Saddlebag Removal

34. Unlock and unload saddlebags. Remove saddlebag liners, if present.
35. Refer to Figure 13. Pull each of the fastener handles open.
36. Turn each of the three fasteners 1/4 turn to the front to release saddlebag from support bracket.
37. Repeat for the opposite saddlebag.

### **WARNING**

Saddlebag support brackets are not “grab handles” for passenger. Using the support brackets as passenger grab handles could result in death or serious injury.

## Saddlebag Operation

38. See Figure 16. Place key in saddlebag lock and turn 1/4 turn.
39. Lift saddlebag latch.

### **CAUTION**

Do not rest items on an open saddlebag cover. Placing objects on an open saddlebag cover could damage cover and mounting hardware.

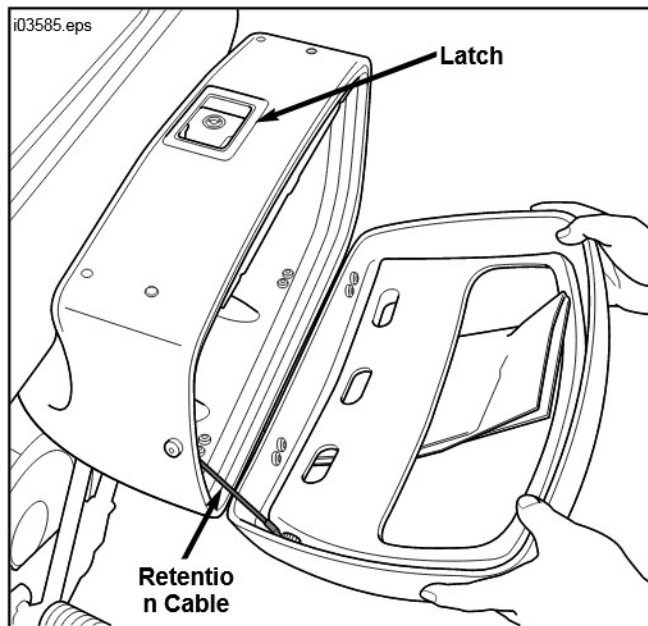

Figure 16. Saddlebag Lid Compartment

### **WARNING**

Keep cargo weight concentrated close to the motorcycle and as low as possible to minimize the change in the motorcycle's center of gravity. Distribute weight evenly on both sides of the vehicle and do not load bulky items too far behind the rider or add weight to the handlebars or front forks. Do not load saddlebag beyond maximum weight capacity. See label inside saddlebag for weight capacity limit. Improper loading can adversely affect handling, leading to death or serious injury.

Buell S2/S2T Saddlebag Conversion Kit

i03586.tif

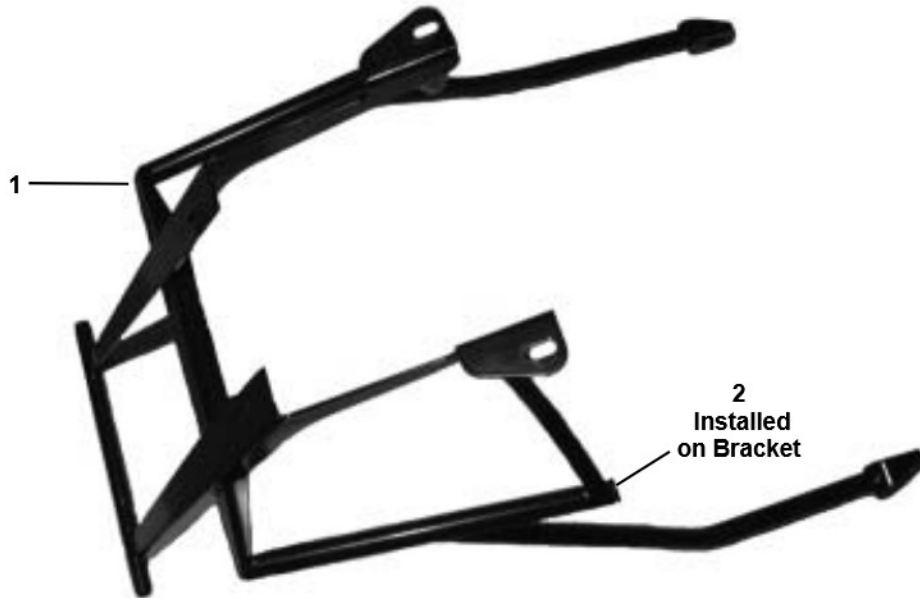

i03587.tif

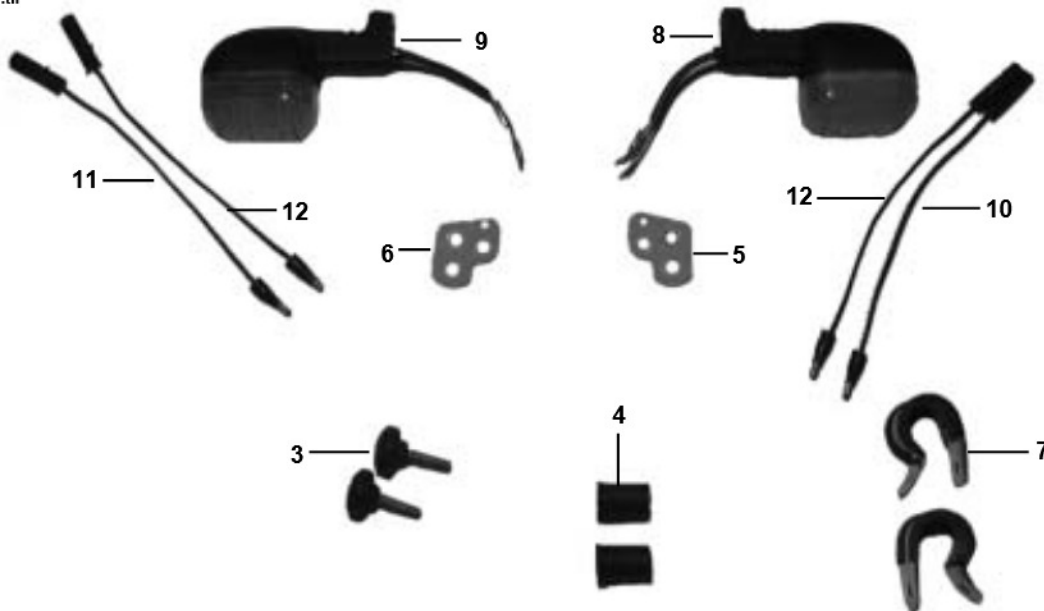

Item	Description	Part Number	Item	Description	Part Number
1	Bracket, saddlebag	L1025.8	13	Kit, saddlebag	(not shown)
2	Endcaps, saddlebag bracket (2)	C0173.8		Specify type and color	
3	Bumper, saddlebag w/bolt	C3011.EA			
4	Bumper, saddlebag sleeve (2)	C3012.E			
5	Bracket, turn signal (right)	M0623.8			
6	Bracket, turn signal (left)	M0624.8			
7	Clamp, 3/4 (2)	O0650.8			
8	Turn signal, right rear	Y0503.9			
9	Turn signal, left rear	Y0504.9			
10	Wire, extension (brown)	YH001.B			
11	Wire, extension (purple)	YH002.B			
12	Wire, extension (black) (2)	YH003.B			

**NOTE**

See details for Saddlebag types and colors on Page 8

## Buell S2T Saddlebag Conversion Kit

i03588.tif

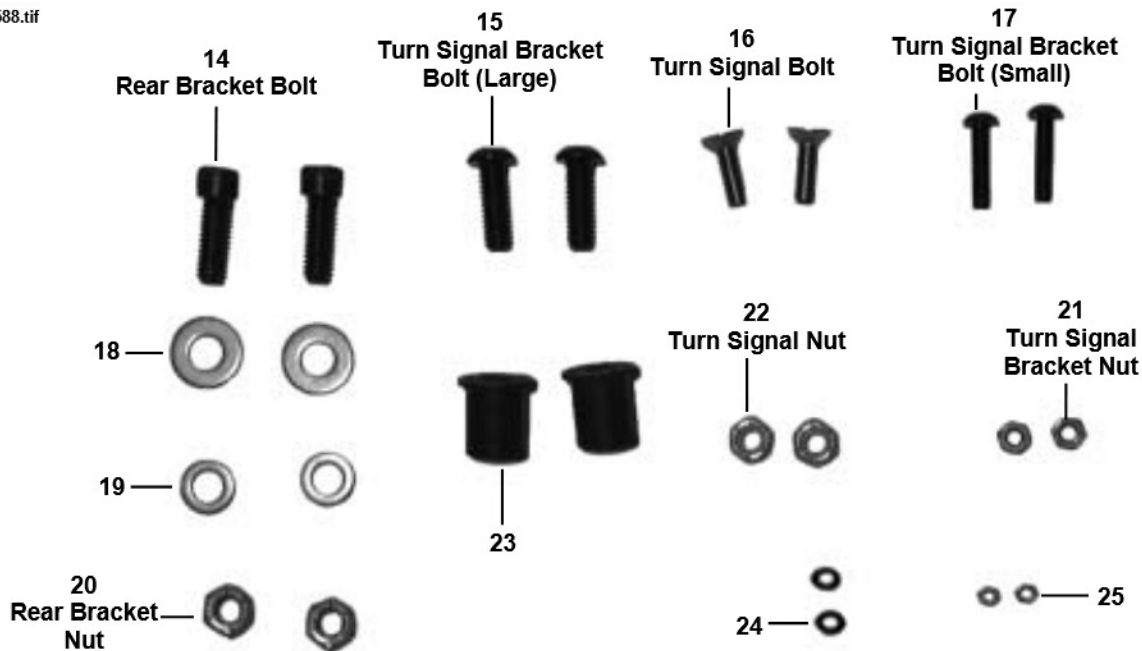

Item	Description	Part Number
14	Screw, 1/4x20x3/4 inch socket head (blk) (2)	AA0406.2CBL
15	Screw, 1/4x20x3/4 inch button (blk) (2)	AA0406.3CBL
16	Screw, #10x5/8 inch flat head countersunk SS	AN 1005.5FSS (2)
17	Screw, 8-32x3/4 inch button head (blk) (2)	AN0806.3CBBL
18	Washer, M6x13 flat (2)	B0613.1Z
19	Washer, 1/4x9/16 flat (2)	BA0409.1Z
20	Nut, 1/4x20 lock (2)	DA0400.10CZ
21	Nut, 8-32 (2)	DN0800.1CZ
22	Nut, 10-32 nylock (2)	DN1000.2FZ
23	Wellnut (2)	M0705.3
24	Washer plastic, fairing nose (2)	M0603.4
25	Jam nut 1/4-20 (2)	DA0400.4CZ
26	Wiretie 5/32 inch, blk 8.5 (2) (not shown)	Y0303.2B
27	Wiretie 7/64 inch, blk 8.5 (not shown)	Y0305.8B

## Specific Saddlebag Ordering Information

Saddlebag Kit (Deep)	Color	Part Number	Saddlebag Kit (Narrow)	Color	Part Number
"	Primed	Z0725.8PMD	"	Primed	Z0700.8PMD
"	Quicksilver Metallic	Z0725.8YAA	"	Quicksilver Metallic	Z0700.8YAA
"	Black Sapphire	Z0725.8YAC	"	Black Sapphire	Z0700.8YAC
"	Candy Blue	Z0725.8YYAE	"	Candy Blue	Z0700.8YAE
"	Yellow Jacket Pearl	Z0725.8YAF	"	Yellow Jacket Pearl	Z0700.8YAF
"	Parkway Blue	Z0725.8YAG	"	Parkway Blue	Z0700.8YAG
"	Canyon Red	Z0725.8YC	"	Canyon Red	Z0700.8YC
"	Red Snap	Z0725.8YH	"	Red Snap	Z0700.8YH
"	Ice White Pearl	Z0725.8YN	"	Ice White Pearl	Z0700.8YN

**Saddlebag Liners** not shown (Specify)  
 Liner, saddlebag, deep (left) C0799.M  
 Liner, saddlebag, deep (right) C0800.M

**Saddlebag Liners** not shown (Specify)  
 Liner, saddlebag narrow (left) C0804.M  
 Liner, saddlebag narrow (right) C0805.M



# DRILL TEMPLATES

*Note Measure the lines to verify the template is properly sized. Each line measures exactly one inch.*

