

Tuscany & Montego

(Style C10, C101 and C20)

Installation Instructions



- It is the responsibility of the installer to meet all code and safety requirements, and to obtain all required building permits. The installer should determine and implement the installation techniques appropriate for each unique installation situation. Digger Specialties, Inc. and its distributors shall not be held liable for improper or unsafe installations.

Standard (Level) Railing

Note: Top rail is 1" longer on each end to accommodate Crossover Railing.

- Cut the rails to length by holding rails against posts. Position so there will be the same baluster spacing on each end of the rails if possible. Mark rails where they are to be cut. **Make sure rail is cut 1/4" shorter on each end to allow for mounts.** Cut rails. A minimum of 1 1/4" spacing is required between first baluster and post (Example 1).

Crossover Railing- Cut bottom rail same as above. For top rail, make end spacing exactly 1" longer on all ends connecting to a line crossover (Example 2).

If connecting to a corner crossover cut the top rail the same as the bottom rail.

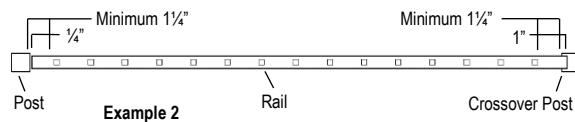
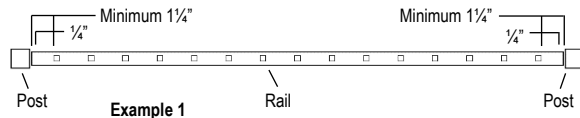

- Attach bottom wall mount to post by positioning the bottom rail so there is no more than 2" clearance. Keeping mount centered on post, fasten mount to post with pan head self-tapping screws (provided). A 1-3/8" spacer may be placed on the welded 3/8" plate of the post to reach the 2" clearance. Use a 1-1/4" spacer for posts with 1/2" plate.
- Attach top wall mount to post by measuring up 32-5/8" (for 36" tall railing) or 38-5/8" (for 42" tall railing) from the top of the bottom mount to the top of the top mount. Keeping mount centered on post, fasten mount to post with self-tapping pan head screws (provided).

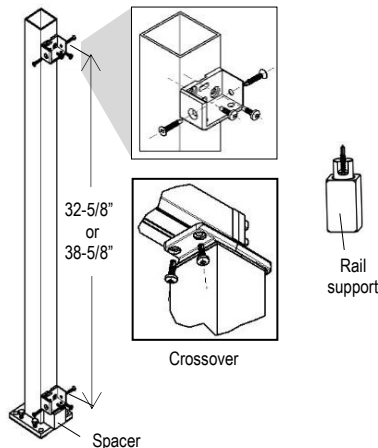

Standard (Level) Railing Cont'd

- Place bottom rail on clean flat surface. Using a rubber mallet, tap balusters into routed holes making sure balusters are seated all the way into the rail.
- Hold top rail at an angle above the balusters. Starting at one end feed first baluster into rail and tap lightly with a rubber mallet.
- Feed remaining balusters into top rail, tapping lightly with a rubber mallet as you move to the other end. Once all balusters are partially seated in rail tap with rubber mallet along full length of rail making sure all balusters are against the top rib of the rail.
- Fasten rail support to bottom side of bottom rail by inserting pan head self-tapping screw (provided) through center of threaded portion of support. This applies to all sections over 6' long.
- Place section into mounts. Fasten top and bottom rails through side of mount with flat head screw provided. Crossover railing- Fasten top rail to crossover adaptor with pan head screws provided.
- Carefully align mount cover on mount base before applying even, downward pressure to snap cover into place. (Mount Covers can be damaged if the above process is not followed).
- Attach 2 piece flairs to all posts.
 - Separate two piece flair.
 - Slide u-shaped flair around bottom of post.
 - Use rubber mallet to tap flair together.

Angle (Swivel) and 45° (Fixed) Mounts

- Position bottom swivel mount base so the bottom of the rail has no more than a 2" clearance. **NOTE: A 1 1/8" spacer may be placed on the welded 3/8" plate of the post to reach the 2" clearance. 1/4" spacer for 1/2" plate.**
 - Measure up 32 5/8" (for 36" tall railing) or 38 5/8" (for 42" tall railing) from top of bottom mount to top of top mount.
- Keep base of mount centered and pin hole turned down, fasten base to post with pan head self-tapping screws (provided).
- Angle the swivel mount after it is installed on post. Measure from back of cup at one end to back of cup at other end to determine rail length. Cut rails.
- Assemble sections as specified in Standard (Level) railing steps 4-10.

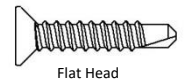
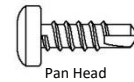

Note: If using 45° (Fixed) Mount on posts larger than 3" you will need to offset mount from center to install both side entry screws.

Tuscany & Montego

(Style C10, C101 and C20)

Installation Instructions



- It is the responsibility of the installer to meet all code and safety requirements, and to obtain all required building permits. The installer should determine and implement the installation techniques appropriate for each unique installation situation. Digger Specialties, Inc. and its distributors shall not be held liable for improper or unsafe installations.

Stair Railing

Important: Rails must be positioned in the correct direction prior to cutting. If rails are not in the correct position they may be cut incorrectly and balusters will not line up. Rails will have a small hole at one end that indicates the lower end of the stairs.

- Identify top and bottom stair rails.
- Cut balusters at angle of stairs on both ends. (Overall length of baluster will not change.)

- Lay bottom rail beside posts with approximately 1" clearance (use 1" spacer) between the rail and nose of step. Insert a baluster into the last hole on each end. Place top rail on these balusters.

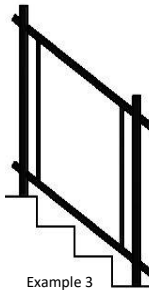

- Position rails against posts and even the end spacing on each end, **if possible**, with balusters parallel to the post. Clamp rails to post (Example 3.) Mark rails for cutting. Mark posts for each mount position (Example 4). Cut rails 3/16" shorter than mark on each end. Rails should be cut using a straight cut (Example 5).

- Crossover Railing:** For crossover stairs set stair crossover kit next to rails that are fastened to post to determine what height to cut post. Mark post and cut. Set crossover connector in post and fasten at proper height with self-tapping pan head screws provided. Set correct angle for crossover connector to match railing and tighten nut. Cut bottom rails same as above in step 3 (Example 3). Mark top rails to cut making sure it fits snug into the crossover connector (Example 6).

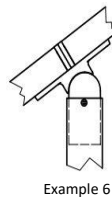
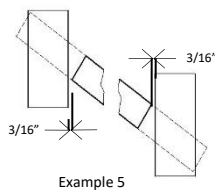
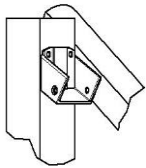

- Attach mounts to post with pan head self-tapping screws (provided).
- Place bottom rail on clean flat surface. Using a rubber mallet, tap balusters into routed holes making sure balusters are seated all the way into the rail.
- Hold top rail at an angle above balusters. Starting at one end feed first baluster into top rail and tap lightly. Feed remaining balusters into rail, tapping lightly as you move to the other end. Once all balusters are partially seated in top rail, go back and tap along full length of the top rail making sure all balusters are seated against top rib.
- Place section into mounts. Fasten top and bottom rails through side of mount with flat head screw provided. Crossover railing- Fasten top rail to crossover adaptor with pan head screws provided.

Stair Railing Cont'd

- Carefully align mount cover on mount base before applying even, downward pressure to snap cover into place. (Mount Covers can be damaged if the above process is not followed).
- Attach 2-piece flairs to all posts. See step 10 of Standard Level Railing section.

Swivel Stair Mount

Identify top and bottom rails, top swivel mount and bottom swivel mount.

- Lay bottom rail (with approximately 1" clearance from the nose of the steps) beside the posts. Determine where the end holes will be on each end and place a baluster in those holes. Place top rail on these balusters. Holding rails against posts, determine end spacing making sure end spacing is even between post and balusters. Clamp rails to post (Example 1). Hold swivel stair mounts up against posts and beside the rail to determine where rails are to be cut to fit inside the swivel stair mounts. Mark posts for each stair swivel mount position (Example 7). **NOTE: This will vary depending on angle of stairs.** Cut rails. Cut top rail at same length as bottom rail unless using crossover application.
- Attach bottom swivel mount base so the bottom rail has approximately 1" clearance from the nose of the step. (**NOTE: A 1" spacer may be placed on the nose of the step to reach the 1" clearance.**) Fasten base to post with pan head self-tapping screws (provided).
- Attach top swivel mount base to post using pan head self-tapping screws (provided).
- Follow Stair Railing steps 7-11 for assembly of section.

