

LED Teardrop Side Light

Installation Instructions

- It is the responsibility of the installer to meet all code and safety requirements and to obtain all required building permits. The installer should determine and implement the installation techniques appropriate for each unique installation situation. Digger Specialties, Inc. and its distributors shall not be held liable for improper or unsafe installations.
- These instructions must be followed exactly as written and the materials used must be exactly as shown in the instructions. Any deviation from the instructions or variation in the materials used/installed may result in an unsuccessful installation and will void the warranty.

Parts List

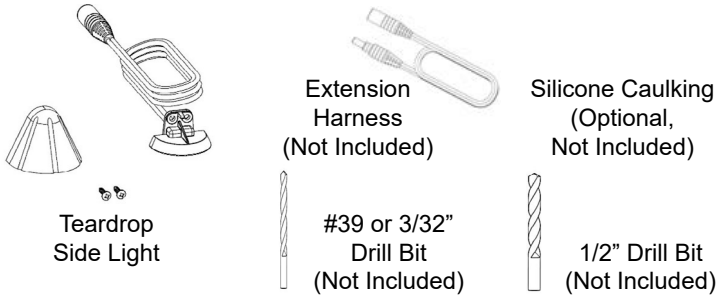

Step 2: Prepare the Post and the Back Plate

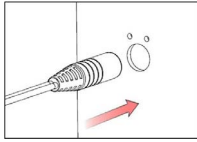
1. Place the template (located at the bottom of this sheet) at the desired location and pre-drill the two screw holes with a #39 drill bit and one 1/2" hole for the wire and connector to pass through. A center punch at the drill locations will help keep the drill centered.
2. The light has a 42" lead with a female connector on the end. Pass the female connector through the 1/2" hole in the post. An extension harness (not included) can be used if more than 42" is needed to get to the top or bottom of the post. 

Important Notes

- The use of non Magena Star® products with Magena Star® Lighting including Transformers, Wire Harnesses, and Splitters may void the warranty.
- Do not cut any wires. Any extra wire length can be coiled.
- Ensure that staples, used to hold wires in place, and all other screws or brackets will not damage or pinch any of the wires.
- Connections can be made by firmly pushing the male and female connectors together and slightly twisting while pushing.
- During installation, it is recommended that you confirm each light is functional before installation is complete.

3. If the main wiring will be run at the bottom of the railing, the female connector should be at the bottom of the post. Alternatively, the female connector should be ran to the top if the main wiring will run inside or under the top rail. A string or extension grabber tool can be used to get the connector to the desired location.

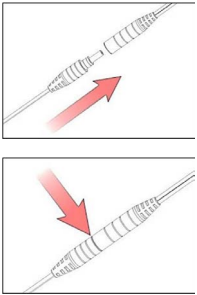
4. Plug the female connector (from Step 2) into the male connector that is connected back to the transformer. Press firmly while twisting until the connection is fully engaged. There should be little to no gap between the connectors. If the transformer is turned on, the light should be illuminated. 

Step 1: Prepare the Transformer and Wiring Harness

1. Follow instructions provided with the DSI Magena Star® Transformer.
2. Follow instructions for the wiring harnesses so there is a male connector located at each location that will have a light installed.

Drilling Template

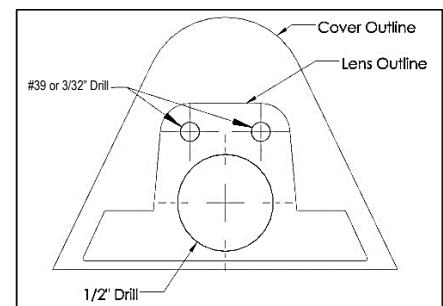

Continued on Page 2

LED Teardrop Side Light

Installation Instructions

- *It is the responsibility of the installer to meet all code and safety requirements and to obtain all required building permits. The installer should determine and implement the installation techniques appropriate for each unique installation situation. Digger Specialties, Inc. and its distributors shall not be held liable for improper or unsafe installations.*
- *These instructions must be followed exactly as written and the materials used must be exactly as shown in the instructions. Any deviation from the instructions or variation in the materials used/installed may result in an unsuccessful installation and will void the warranty.*

Step 2 Continued:

5. Carefully push the wire attached to the light through the 1/2" hole until the back of the light is flush with the post.

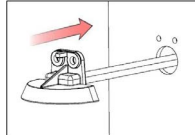

6. Carefully push the wire and connection back through the 1/2" hole until the back of the light is flush with the post.

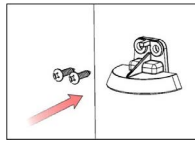

7. Align the screws with the pre-drilled holes. Using a hand screw driver (power drivers not recommended), tighten the included stainless steel screws to mount the light to the post.

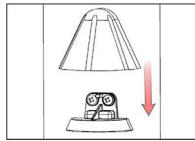

8. Align the cover above the light and push the cover down completely onto the lens.
9. OPTIONAL: After the light is confirmed working, lift the cover off of the light and apply a small amount of clear exterior silicone caulking (not supplied) to keep the cover in place.