

DesignRail®

Create Your Own

feeney®



Feeney[®] makes it easy

Lovely for the long haul

DesignRail[®] lets you create lasting beauty with high strength 6000-series aluminum extrusions and powder-coated finishes that don't rust, peel or require repainting.

Simple sophistication

Feeney's DesignRail[®] makes it easy to create beautiful railings inside and out. The component-based aluminum railing system is pre-engineered, simple to design, and easy to install.

Just your style

Whether your project is traditional or modern, residential or commercial, large or small, DesignRail[®] railings fit beautifully in any architectural setting.

Embrace your environment

DesignRail[®] systems are strong, durable, and made with over 70% reclaimed content. That's perfect for LEED rated buildings and anyone who wants an environmentally friendly space.



IMAGE: TREVE JOHNSON PHOTOGRAPHY

Create Your Own

STEP
1

Select a railing height

PG. 5

STEP
2

Select a mounting type

PG. 5

STEP
3

Select an infill type

PG. 6-7

STEP
4

Select a top rail style

PG. 9

STEP
5

Select a frame color

PG. 9

STEP
6

Choose accessories

PG. 10

STEP
7

Easy installation

PG. 12

DesignRail® details make all the difference

DesignRail® aluminum railings combine the durability of aluminum with innovative design details to ensure lasting beauty, structural integrity, affordability, and very low maintenance.

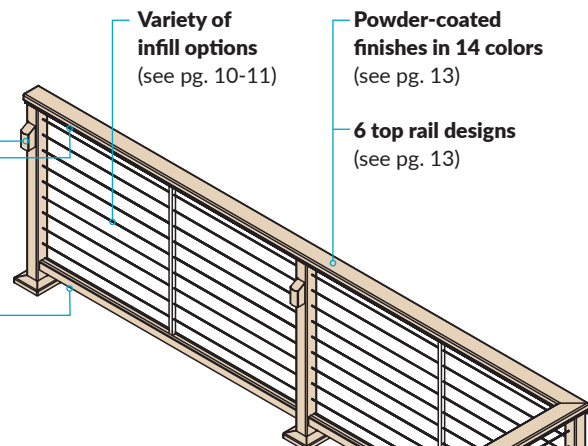

Variety of infill options
(see pg. 10-11)

Powder-coated finishes in 14 colors
(see pg. 13)

6 top rail designs
(see pg. 13)

Low voltage, LED lighting options
for posts and rails. (see pg. 14)

Heavy duty end posts are specially engineered to support the tension loads of horizontal CableRail cable infill. (see pg. 9)

45° corner posts offer the option of a single post at 45° corners. Available in standard and commercial base mount profiles. (see pg. 9)

Custom fabricated gate options
(see pg. 14)

4 post mounting options
(see pg. 9)

Bottom rail is optional when using horizontal CableRail cable infill. (see pg. 10)



Isolation bushings and pads are available for all post, picket holes and post bases when installing railings in harsh, salt-air environments.

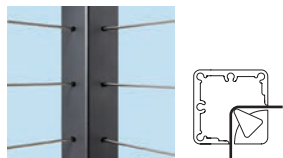

90° Single corner posts for 1/8-inch CableRail cable infill allow the cables to run continuously through a corner without terminating. One post in each corner versus two means faster installation, less cost, and a more open, beautiful view. Available in all post mounting styles, except stanchion mount. Use Curved Lacing Needle (#3221-curve) to install cables.



Base plate covers add a finished detail to base mounted posts. Powder-coated to match the railing color. (see pg. 14)



Pre-drilled, trim-to-fit stair posts and pickets for 1/8-inch CableRail cable infill save installation time and money. Available in 3 angle ranges (23°-28°, 29°-34°, 35°-39°) and all post mounting styles.

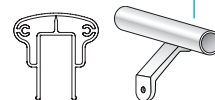

Graspable top rail or applied handrail options to meet stair railing code requirements. (see pgs. 13-14)

Create Your Own

DesignRail® railings are easily adaptable to any exterior, interior, commercial, or residential project. Simply choose from the style options to create your perfect railing design.

STEP

1

Select a railing height

Posts for horizontal railings come pre-cut for 36-in, 38-in and 42-in railing heights. Stair or custom posts must be cut to height in the field and extrusions can be ordered in 10-ft or 20-ft lengths for that purpose. When using horizontal cable infill, all posts, including stair posts, are available pre-drilled for the cables.



Building codes in your area may require your rails to meet a minimum height. Consult your local building codes when choosing a height for your project.

STEP

2

Select a mounting type

Posts are made from 2 $\frac{3}{8}$ -in square tube extrusions in three distinct cross-sectional profiles: Standard, Commercial Base Mount, and Heavy Duty. Each is specially engineered to provide optimal structural strength and design performance for specific usage and load conditions. Our customer service team will determine which posts are required depending on the type of project and the railing design options selected.

Our 90° single corner posts and pre-drilled stair posts and pickets will reduce installation time and save money when using horizontal CableRail cable infill (see pg.7).

POST TYPES (Determined by project type, railing usage and conditions)

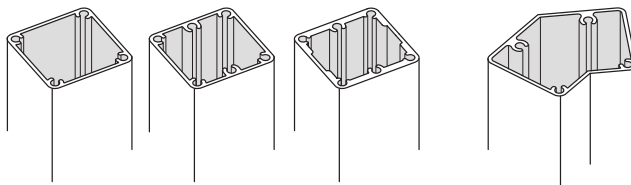

Square posts
Standard, Commercial Base Mount, and Heavy Duty profiles available.

45° posts
Standard and Commercial Base Mount profiles available.

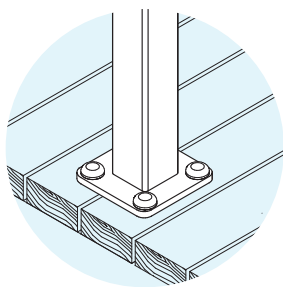

BASE MOUNT

- For top mounting to deck, patio, floor, or stair tread surfaces
- $\frac{3}{8}$ -in thick by 5-in square base plate for square posts and $\frac{3}{8}$ -in thick with a 1 $\frac{5}{16}$ -in contour reveal for 45° posts
- Plates come pre-attached to posts
- Optional decorative base plate covers are available (see pg. 14)

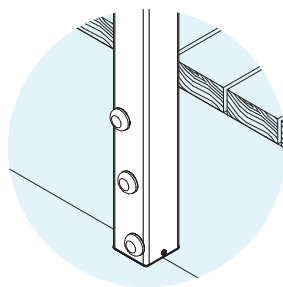

FASCIA MOUNT

- For side mounting to fascia boards, joists, or walls
- Posts come with pre-drilled bolt holes

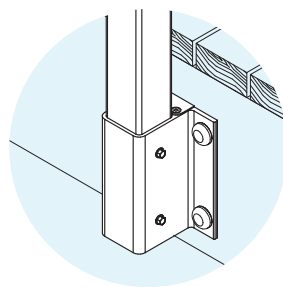

FASCIA BRACKET MOUNT

- For side mounting to fascia or rim joists when decking or nosing trim extends beyond the edge of the fascia board
- Posts are attached using metal brackets that have 1 $\frac{1}{4}$ -in standoff
- Railing may require a bottom rail when using this method

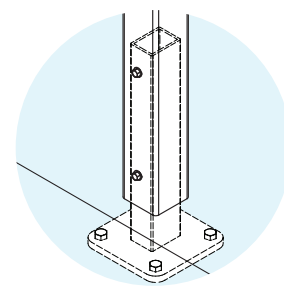

STANCHION MOUNT

- For mounting with stone or tile covered concrete slabs or on roof decks where penetration of waterproof roofing membranes must be minimized
- Short stanchions are attached to the structural members prior to pouring the slab or laying the roof membrane. Railing posts are then sleeved over the protruding stanchion ends and secured with screws
- Available in steel, aluminum or stainless steel

Select an infill type

The basic infill options are illustrated below. However, Feeney can also assist with custom infill options such as textured, etched, or decal'd glass panels; special picket designs; and wood strips or panels for solid barriers or fences.

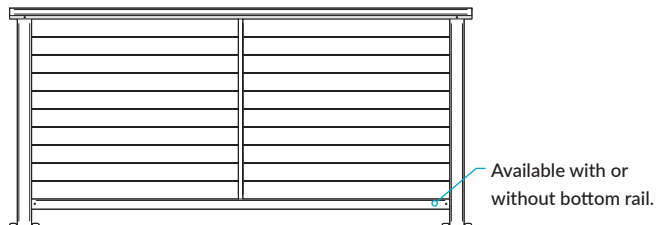

HORIZONTAL CABLES

- Pre-fabricated 1/8-in diameter stainless steel CableRail Kits for easy cable installation
- A vertical intermediate picket is used mid-span to minimize cable deflection
- All posts and pickets come pre-drilled for cables

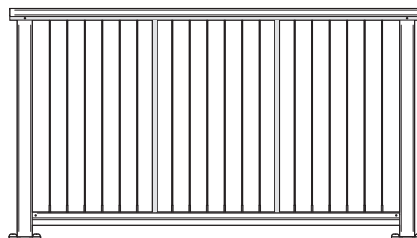

VERTICAL CABLES

- 1/8-in diameter 316-grade stainless steel cables come prefabricated to size with all of the attachment fittings, ready to install
- Two vertical intermediate pickets are spaced mid-span to maximize frame rigidity

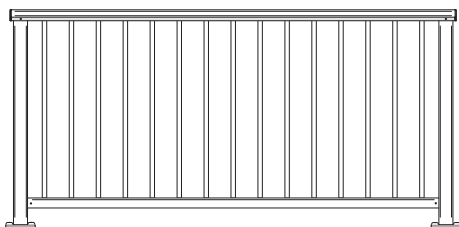

VERTICAL PICKETS

- 3/4-in square aluminum pickets powder-coated to match the frame color
- Available in pre-assembled panels that can be trimmed to length

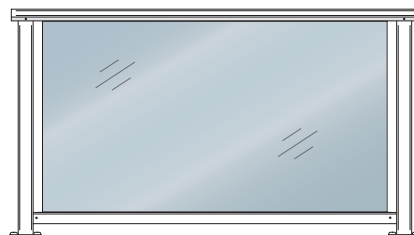

TEMPERED GLASS

- Clear or custom tinted panels that are easily inserted into vinyl lined slots in the Top Rail and Bottom Rail
- No special mounting hardware needed
- Glass panels are pre-cut to fit the final opening measurements



More infill types

We now offer various panel designs that easily fit into the pre-engineered DesignRail® frame. All panel infills are available in 36-in and 42-in heights.

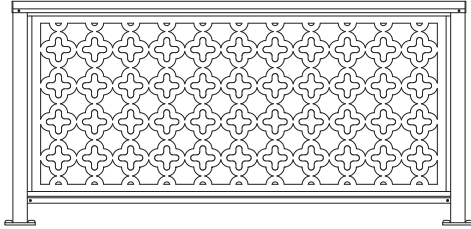

LASER CUT ALUMINUM PANELS

- Available in any power-coated DesignRail® color
- At 36-in height, max width is 6ft
- At 42-in height, max width is 5ft

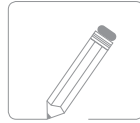

DESIGN YOUR OWN



SVERRA™



PULSE™



PISCES™



CUBIST™



BOUND™



RHYTHM™



SEAGRASS™



AGAMA™



TRILLIUM™

Additional patterns and custom designs are available through Feeney Design Services.

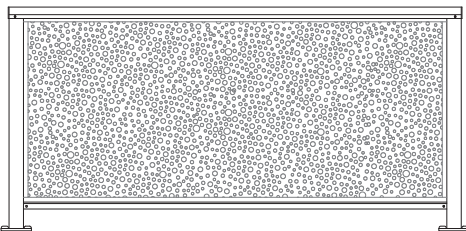

RESIN PANELS

- At 36-in and 42-in height, max width is 5ft
- Interior applications only

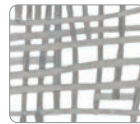

CONNECTION SQUARE GRAY



TING TING



GINKO THATCH



RICE GRASS



KATHALI GRAYS



BAMBOO RINGS NATURAL



BAMBOO RINGS DARK

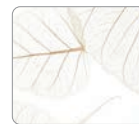

FOSSIL LEAF SPADE NATURAL

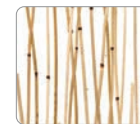

THATCH 50 PERCENT



BEAR GRASS LITE

For more styles please visit feeneyinc.com.

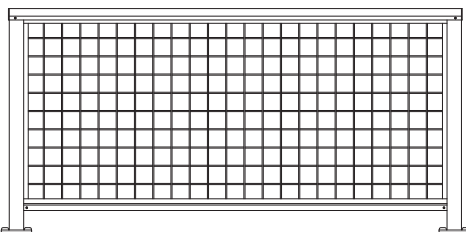

STAINLESS STEEL MESH PANELS

- At 36-in height, max width is 6ft
- At 42-in height, max width is 5ft



ALLURE™



DAZZLE™

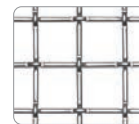

METROPOLITAN™



HORIZON™

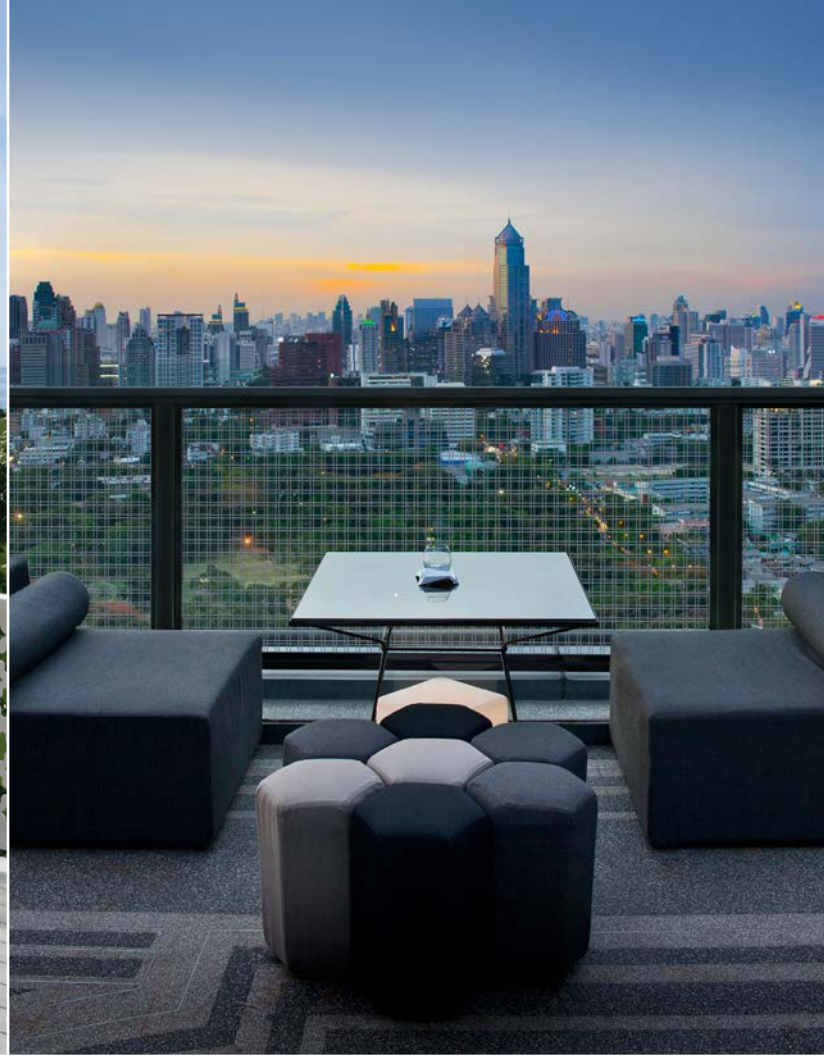

STEP

4

Select a top rail style

Top rails come in 6 styles and are sold in 10-ft and 20-ft lengths that can be trimmed to size in the field. Series 150 Graspable Top Rails are used on stairs to provide a graspable rail option. Series 150 and Series 100 Top Rails are attached to the faces of the posts using Rail Connecting Brackets (RCBs). Series 200, 300, and 450 Top Rails rest on the tops of the posts and are secured with stainless steel screws. Applied Continuous Handrails with extensions and returns are available as an accessory item to meet ADA and code handrail requirements (see page 14).

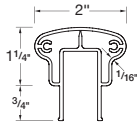
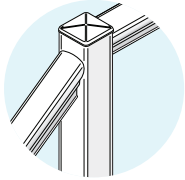

GRASPABLE TOP RAIL (Series 150)

- 2-in wide top rail with easy-to-grasp shape
- Can be used for both stair and horizontal railings
- Meets residential code requirements for stair handrail sizing. Requires a handrail when used on stairs in commercial settings
- Available in new woodgrain colors* (Weathered Gray, Cherry, Walnut)

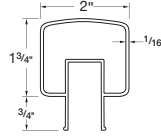
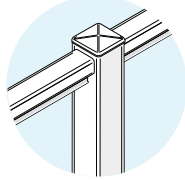

SQUARE TOP RAIL (Series 100)

- 2-in wide square-shaped top rail
- The narrow width allows it to be installed between posts (using RCBs) instead of on top of posts, creating a newel-post-style railing with posts rising above the top rail

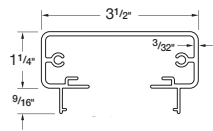
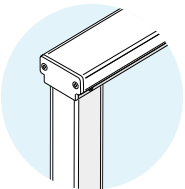

RECTANGLE TOP RAIL (Series 200)

- 3½-in wide rectangular top rail
- The flat surface is a convenient perch for your favorite beverage as you relax and gaze at the view
- Requires a handrail when used on stairs
- Available in new woodgrain colors* (Weathered Gray, Cherry, Walnut)

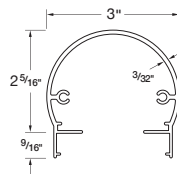
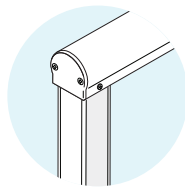

ROUND TOP RAIL (Series 300)

- 1½-in radius top rail
- The smooth rounded shape offers a more contemporary accent to those less traditional architectural designs
- Requires a handrail when used on stairs

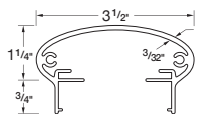
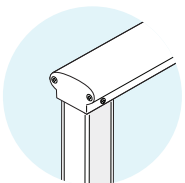

ELLIPTICAL TOP RAIL (Series 350)

- 3½-in wide elliptical top rail
- The sleek, stylish design offers another option for those who prefer a less angular top rail appearance
- Requires a handrail when used on stairs

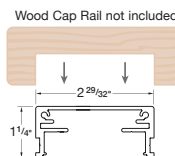
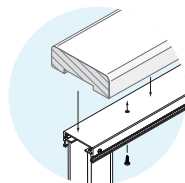

-PROFILE TOP RAIL (Series 450)

- Low-profile top for adding your own wood or composite cap rails
- Cap rails are optional and are not included
- Requires a handrail when used on stairs

STEP

5

Select a frame & top rail color

Our frames are available in 14 standard colors and over 200 custom colors which are finished with rigorous AAMA-2604 coating specifications for superior color retention, impact resistance, and weather protection.

TEXTURED BLACK

WHITE

GREEN

GRAY

CREAM

BLACK MATTE

BRONZE MATTE

TAUPE

SILVER

RED HOT RED

ORANGE YOU SASSY

BLAZING BLUE

NOT A MELLOW YELLOW

MARGARITA GREEN

CUSTOM COLORS

WOODGRAIN TOP RAIL OPTIONS*

WEATHERED GRAY

CHERRY

WALNUT

The color samples shown above represent approximate colors only. Woodgrain only available on 150 & 200 cap rail options

Choose accessories

Feeney Lighting

Our 24v lighting is manufactured with high quality, weatherproof materials for reliable performance, and energy efficient 50,000 hour-rated LEDs with a high color rendering index (80+) for truer colors. Plug & play connectors make installations a breeze. All kits are UL certified.

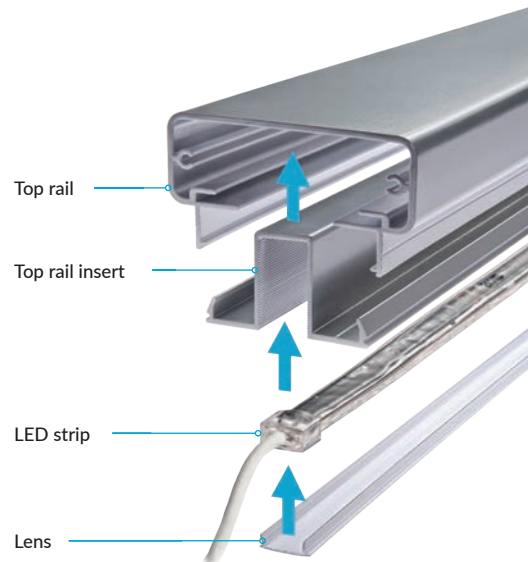
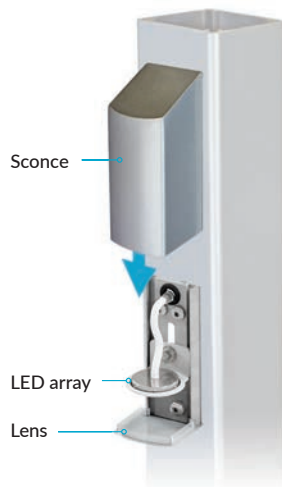

POWER KITS

Outdoor rated 24 volt dimmable drivers in 40, 60, and 96 watt (all driver kits sold separately).

POST ACCENT LIGHT

The decorative aluminum sconce has a durable powder-coated finish and attaches to the post face to create a beautiful down light; great for stair railing accents. The sconce can be finished to match the railing frame color, and can be used with all infill options.

FEENEY RAIL LIGHTING

Easy-to-install kits that integrate into the top or bottom rail to provide beautiful under-rail lighting. Each weatherproof lighting strip includes a high-bond, waterproof adhesive for easy installation. Our exclusive Feeney polycarbonate lens diffuses light evenly across the railing.

Compatible in top rail, when using horizontal CableRail infill only. Compatible in bottom rail when using horizontal CableRail, glass, or picket infill only.

Other accessories



GATES

Custom fabricated to size and available for all railing styles and infill types. Comes with gate hardware accessories.



HANDRAILS

1½-in diameter aluminum handrails meet stair railing code requirements and are available with ADA compliant extensions and returns. Handrails are custom bent and fabricated, ready to install, and are powder-coated to match the railing frame colors.



BASE PLATE COVERS

Decorative base plate covers add a finished detail to base mounted posts, and they come powder-coated to match the railing color. The two-piece design allows easy installation for both new and retrofitted railings.



INTERMEDIATE HORIZONTAL RAIL

Used for creating railing designs with partial height infill. Sold in 10-ft and 20-ft lengths that can be trimmed to size in the field. Attaches to the post using Rail Connecting Brackets (RCBs). *Can be used with all infill options.*



Care & maintenance

- As necessary, clean the railing frame with mild soap and water using a non-abrasive sponge or cloth. Be sure to wipe-up any bird droppings or sap drips as soon as possible to avoid possible staining or discoloration.
- Never use steel wool, sandpaper, acid, bleach or other abrasive or caustic materials on your railings as they may cause permanent damage to the finish.
- Use a good quality automotive cleaner/polish. This will help to brighten and extend the life of the finish.
- Periodically check to see that all components and screw connections are tight and secure, and re-tighten as needed.
- If using touch-up paint, be sure the surface being painted is clean and dry. Always follow the painting instructions on the bottle.
- Use a cleaner and protectant like Feeney's SteelRenewal® and SteelProtect® regularly to help prevent the staining and corrosion of stainless steel products.

STEP

7

Easy installation



For a complete step-by-step installation instructions and details, visit feeneyinc.com/designrail

1 INSTALL POSTS

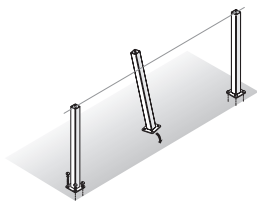

Install the posts starting with the end and corner posts, continuing on to the intermediate posts.

2 ATTACH TOP RAILS

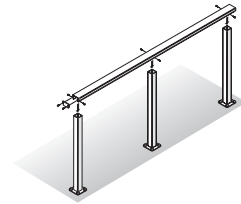

Measure and cut the top rails and attach to posts using screws. If using Series 450 top rail, cut and screw on the wood or composite cap rail. If using the Panel Infill, the top rail will go on after the panels are inserted into the frame. (see below)

3 ATTACH RCBs

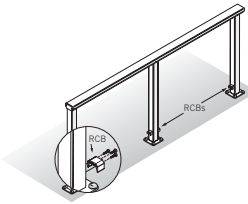

If using bottom rails, screw the Rail Connecting Brackets (RCBs) to the posts for attaching the bottom rails.

4 PREPARE INFILL SUPPORT

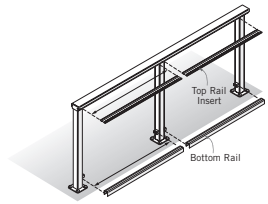

Measure and cut top rail inserts and bottom rails for each panel section.

5 INSTALL INFILL (CHOOSE ONE)

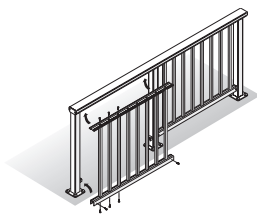

PICKET INFILL

Trim the pre-fabricated panels to length. Lift the complete panel into position on the railing frame and screw in place.

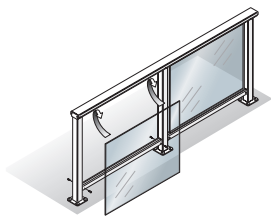

GLASS INFILL

Attach top rail insert and bottom rail to railing frame and insert vinyl liners. Lift the pre-cut panel into the top rail insert, then lower into final position in bottom rail slot.

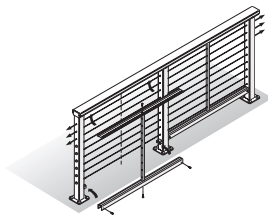

HORIZONTAL CABLE INFILL

Screw intermediate pickets to top rail insert and bottom rail (if using bottom rail), then lift into position on frame and screw in place. Lace cables through pre-drilled holes in posts and pickets, then tighten and trim.

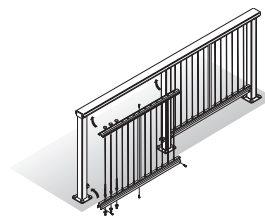

VERTICAL CABLE INFILL

Screw intermediate pickets to top rail insert and bottom rail and loosely attach cables. Lift entire panel into position on railing frame and screw in place. Tighten nuts at bottom for final cable tension.

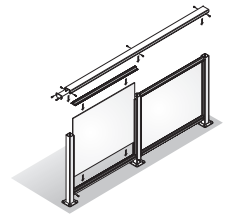

PANEL INFILL

Slide the panel into the railing frame and then attach the top rail.



Enter our photo contest

Send us your project photos for a chance to win cash prizes. Visit feeneyinc.com/photo-contest for details. Also, follow us on Instagram @feeneyinc



Get a quote

For a price quote, contact your local dealer and complete our easy-to-use DesignRail® quote form. Form is also available online at feeneyinc.com/DRQform



www.feeneyinc.com
1-800-888-2418

Reorder # 13701 Date 01/20

AVAILABLE AT: