



**HATSAN**  
ARMS COMPANY

Serious. Solid. Impact.



**HATSAN DOMINATOR SERIES**

**INSTRUCTION MANUAL**

**PLEASE READ THIS MANUAL BEFORE USING YOUR AIR GUN**

Thank you for choosing Hatsan Dominator series fixed barrel/under-lever air rifle.

Your air rifle includes many features, which gives greater handling, greater accuracy and enjoyment.

- Scope mount rail suitable for both 11 & 22 mm scope mounts
- Blued cylinder
- Fixed barrel (Precision rifled steel material)
- Micro adjustable rear-sight for both windage & elevation (except on Carbine versions)
- Open front-sight (except on Carbine versions)
- Truglo fiber optic sights (except on Carbine versions)
- Manual safety, automatic safety and anti bear-trap cocking mechanism
- Ergonomically shaped pistol grip for comfortable hand & wrist position
- Ergonomic design wooden or synthetic stock with raised montecarlo checkpiece
- Elevation adjustable comb
- Stock length of pull spacers to increase the stock length
- 2-stage adjustable Quattro trigger

## Section I. Basic Parts of Your Rifle

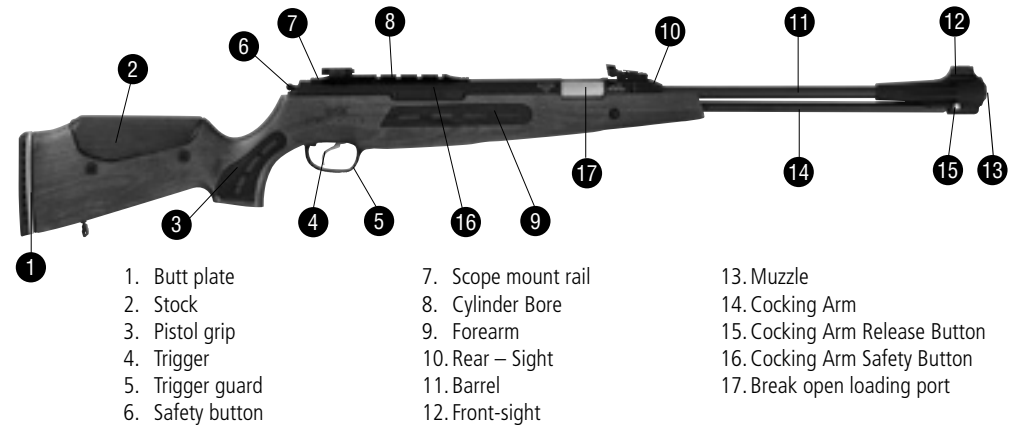

## Section II. Manual Safety

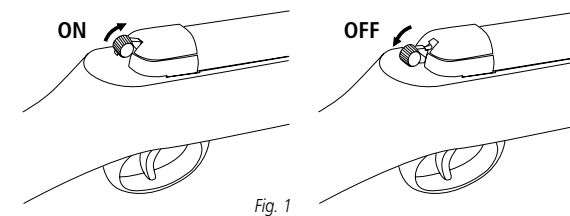

Safety button can be set to 'ON' and 'OFF' position manually.

- To set the safety to 'ON', push safety button upwards. In this position, the trigger cannot be pulled and the rifle cannot be shot. (Fig.1)
- To remove the safety to 'OFF', pull safety button downwards. In this position, the rifle is ready to shoot. (Fig. 1)

## Section III. Automatic Safety & Anti Bear-Trap Mechanism & Cocking Arm Safety

This air rifle is equipped with automatic safety and anti bear-trap mechanism. Automatic safety sets the safety to "ON" automatically during cocking of the air rifle. Anti bear-trap mechanism prevents the safety button being put to "OFF" position when the cocking arm is broken. Automatic safety & anti bear-trap mechanism together prevents accidental pull of the trigger when the air rifle is cocked, so preventing undesirable discharges which may cause damage. Cocking Arm Safety is an additional safety feature which prevents the cocking arm to be closed unless the cocking arm safety button is pushed.

## Section IV. Quattro Trigger

If your air rifle is equipped with Quattro trigger, (Fig. 2), you can adjust "trigger travel" & "trigger pull" as follows:

**BOLT#1** is for trigger pull force adjustment.

For less trigger pull force prior to discharge, rotate BOLT #1 clockwise; and vice versa.

**BOLT#2** is for trigger travel adjustment.

For less trigger travel prior to discharge, rotate BOLT #2 clockwise; and vice versa.

**BOLT#3** is for adjusting the trigger force to pull the trigger till the end of 1st stage. When this is turned clockwise, this force increases; and vice versa

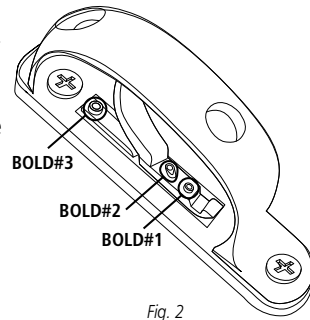

Fig. 2

## Section V. Micro Adjustable Rear-Sight

The rear-sight is a sensitive device and can be adjusted both for elevation and windage by steps of 0.1 mm, meaning 1 mm deviation when shooting to a target 10 m away.

### Windage adjustment

- If the shot is deflected to the left of the target, turn the KNOB1 clockwise. (Fig. 3)
- If the shot is deflected to the right of the target, turn the KNOB1 counter-clockwise. (Fig. 3)

### Elevation adjustment

- If the shot is too high, turn KNOB2 clockwise. (Fig. 3)
- If the shot is too low, turn KNOB2 screw counter-clockwise. (Fig. 3)

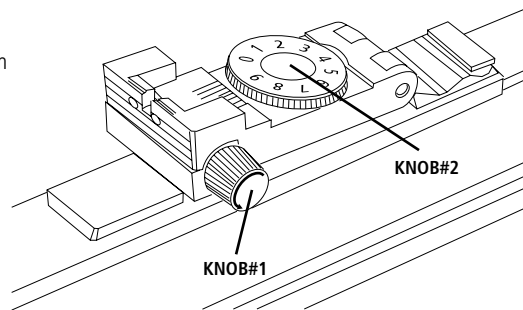

Fig. 3

## Section VI. Operation Instructions

### Cocking the rifle:

Hold the pistol grip with one hand. Push upwards the cocking lever release button and break the cocking arm all the way down with the other hand (Fig. 4 & Fig. 5, Fig. 6 & Fig. 7). Here you will notice that the safety button set to 'ON' position automatically even if you left it in 'OFF' position, which is as a result of automatic safety.

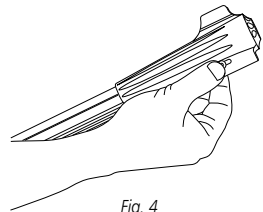

Fig. 4

**CAUTION: Do not leave the rifle cocked for a long time. Otherwise the spring may be subject to fatigue, which decreases the performance of the rifle.**

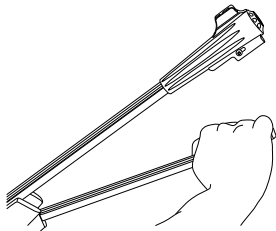

Fig. 5

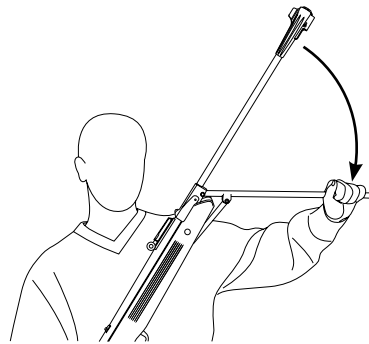

Fig. 6

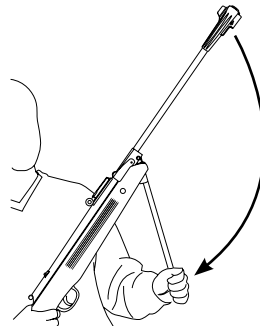

Fig. 7

### Loading & shooting the rifle:

- Load the barrel with only one pellet from as shown in (Fig. 8)
- Press the cocking lever safety button and bring under lever cocking arm to its fully closed position. (Fig. 9)
- Be sure that the cocking arm is closed completely and you hear a click upon closing the cocking arm.
- Sight in\*, disengage safety and get ready for shooting. (Fig. 10)
- Depress the trigger and the rifle will discharge.

(\* ) The rifle is correctly aimed when the front sight blade is positioned exactly in the notch of the rear sight. The sight picture should look like. (Fig. 11)

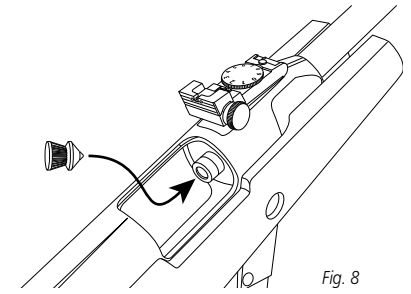

Fig. 8

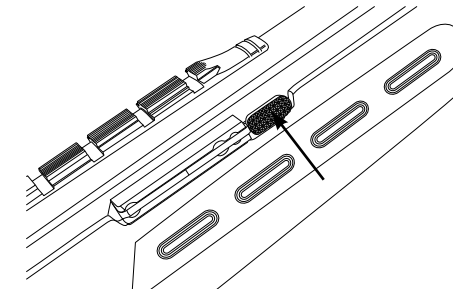
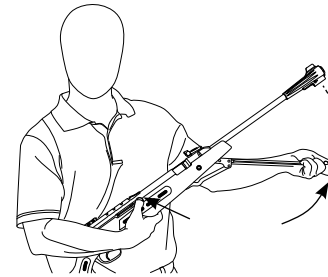

Fig. 9

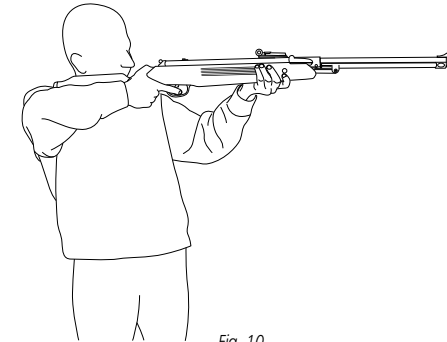

Fig. 10

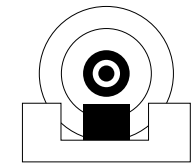
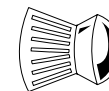

Fig. 11

## Section VII. Ammunition

### Proper use of ammunition

There is, available, a variety of pellet types of varying weights that can be loaded in your air rifle;



Dome head

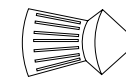

Pointed head

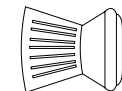

Flat head

The choice of pellet type and weight is very dependent on the intended purpose of the shoot. So, it is recommended to use:

- Flat head pellets for close range shooting and for extreme accuracy
- Dome head pellets for greater impact on the target

- Pointed pellets for considerable expansion
- Heavy weight pellets, especially heavy weight dome head pellets, for maximum penetration & expansion at the target.

Pellet weight and external shape combination plays a very important role on the muzzle velocity and ballistic performance, but weight has the dominant role. Lighter pellets provide higher velocities, usually produce less recoil and give a flatter trajectory path to the target-leads to less guesswork. On the other hand, heavy pellets are more accurate and retain more energy downrange so giving a greater penetration and expansion on the target.

### Safety Measures for Ammunition

- Pellet quality is highly important in order to have effective results. So, use only highquality factory-manufactured pellets.
- Never reuse pellets.
- Do not touch face or mouth after handling pellets. Wash hands after handling pellets.
- Do not oil pellets nor use dirty, corroded, bent, damaged or wet pellets.
- **USE ONLY THE PELLETS OF THE CALIBER, WHICH YOUR AIR RIFLE IS CHAMBERED.**
- Always load your rifle with only one pellet and be sure to load the pellet with the skirt end toward you.
- If you feel unusual resistance when loading a pellet or a shot which sounds notnormal, immediately check the barrel for a possible obstruction.
- If a pellet obstructs the barrel, do not try to remove it by shooting with a subsequent pellet. This may cause serious damage to the rifle and cause serious injury to you or bystanders. In such a case, first try to remove it with a cleaning rod firstly making sure that the rifle is uncocked. If it still cannot be removed take the air rifle to a qualified gunsmith.

## Section VIII. Technical Specifications

Mechanism : Fixed-barrel, under-lever cocking system and single shot

Safety : Manual and automatic safety with anti bear-trap mechanism

Trigger : Adjustable trigger for both trigger travel and trigger pull force.

### SPECIFICATIONS

Model	Caliber	Max. Muzzle Velocity (*)	Stock	Length	Barrel Length	Weight	Fiber Optic Sights Diameters	
							Rear Sight	Front Sight
Dominator 200W	4.5 mm / .177 cal	305 m/s (1000 fps)	Turkish Walnut with adjustable comb and adjustable butt	1156 mm (45.5 ")	450 mm (17.7 ")	4.5 kg (9.9 lbs)	0.9 mm (.035") green	1.5 mm (.060") red
	5.5 mm / .22 cal	245 m/s (800 fps)						
	6.35 mm / .25 cal	200 m/s (650 fps)						
Dominator 200S	4.5 mm / .177 cal	305 m/s (1000 fps)	Advanced Polymer with adjustable comb and adjustable butt	1156 mm (45.5 ")	450 mm (17.7 ")	4.5 kg (9.9 lbs)	0.9 mm (.035") green	1.5 mm (.060") red
	5.5 mm / .22 cal	245 m/s (800 fps)						
	6.35 mm / .25 cal	200 m/s (650 fps)						
Dominator 200W Carbine	4.5 mm / .177 cal	305 m/s (1000 fps)	Turkish Walnut with adjustable comb and adjustable butt	1098 mm (43.2 ")	400 mm (15.7 ")	4.4 kg (9.7 lbs)	-	-
	5.5 mm / .22 cal	245 m/s (800 fps)						
	6.35 mm / .25 cal	200 m/s (650 fps)						
Dominator 200S Carbine	4.5 mm / .177 cal	305 m/s (1000 fps)	Advanced Polymer with adjustable comb and adjustable butt	1098 mm (43.2 ")	400 mm (15.7 ")	4.4 kg (9.7 lbs)	-	-
	5.5 mm / .22 cal	245 m/s (800 fps)						
	6.35 mm / .25 cal	200 m/s (650 fps)						

(\*) Those which have no muzzle velocity or energy restriction. Pellet weight and geometry have an effect on the muzzle velocity.

## Section IX. Care, Cleaning & Lubrication

- Protect your air rifle with rifle oil periodically. It is very important and necessary to oil your air rifle when it is
  - Not used for a long time
  - Shot under dry & dusty conditions
  - Used in wet weather (oil it before & after use in such a case)
- It is recommended to oil your air rifle every 250 shots.
- It is recommended to clean the barrel with a cleaning rod every 500 shots.

- Before you begin oiling or cleaning your air rifle, always check to make sure it is unloaded.
- Always be sure your air rifle barrel is clean and not blocked.
- After cleaning check to be sure that no cleaning patch or other obstruction remains in the barrel.
- Annually, take your air rifle to a gunsmith even if it seems to be working well, since some issues in your air rifle may not be apparent from external examination.
- Take your air rifle to a gunsmith if water, sand, etc. enters the internal mechanism of the air rifle, for complete cleaning.
- Dangerous conditions may occur if you do not keep your air rifle clean and working properly.

## Safety Measures & Warnings

- This air rifle will shoot if cocked, loaded, safety disengaged and trigger pulled.
- Air rifles are not toys. Never let young children use an air rifle unsupervised. Adult supervision is strictly required during use. Misuse or careless use may cause serious injury or death.
- Learn how your air rifle operates and safe rifle handling procedures before loading and using it.
- **ALWAYS USE EYE & HEARING PROTECTION AND MAKE BYSTANDERS USE THE SAME.** Failure to do so may result in eye injuries and permanent hearing loss.
- Do not point at anything you do not intend to shoot even though the rifle is unloaded. Always keep the air rifle pointed in a safe direction.
- Never pull a air rifle toward you by the muzzle.
- Always aim at a safe target, taking care that it does not conceal any other object.
- Before you fire, consider where the pellet will travel should you miss your intended target, thus ensuring no damage or harm could result.
- Be sure of your target before you pull the trigger. Never shoot at sounds.
- When shooting, always have a safe shooting range, that is; have a safe area forshooting, a safe distance between you and the target, and a safe backstop to trap the pellets and hold the target.
- Do not fire at a target, which allows ricochets or deflections.
- Do not fire into or at water.
- Do not fire at or near power lines or insulators. Be especially careful in wooded areas where power lines may not be as visible.
- Do not load the rifle until you are ready to shoot.
- Always keep your fingers away from the trigger & muzzle during cocking and handling.
- Do not walk, run or jump when carrying a loaded or cocked air rifle. A loaded or a cocked air rifle should never be carried inside a vehicle, house, camp or public place.
- Never climb a tree or fence or jump a ditch with a loaded air rifle. In such a case, first unload it and hand the air rifle to a friend or place it on the ground on the other side of the obstacle before crossing yourself.
- When transporting the air rifle, keep it unloaded and 'on safe'.
- Always keep the air rifle 'on safe' until you are ready to shoot even if the air rifle is unloaded.
- Do not put the air rifle away loaded and unattended.
- Always check to see if the air rifle is 'on safe' and unloaded when getting it from another person or from storage.
- **ALWAYS KEEP THE AIR RIFLE AND/OR PELLETS OUT OF THE REACH OF CHILDREN.**
- Keep the air rifle and pellets in separate places, better if under lock and key.
- Do not attempt to disassemble or tamper with your air rifle. Use a competent gunsmith. Many air rifles contain powerful springs which can cause serious injury if released in an uncontrolled manner.
- Always handle and treat your air rifle as though it were loaded.
- Improper use or handling of air rifles is not the responsibility of the manufacturer or distributor, under any circumstances. The user is responsible for any harm, which may be caused.
- Think first, fire second.
- Don't rely on any mechanical safety. Half safe is not safe.
- Be safe not sorry.
- Respect other's property.
- Air rifles should never be used under the influences of alcohol or drugs.



# HATSAN

## ARMS COMPANY

Izmir - Ankara Karayolu 28. km. No. 289  
35170, Kemalpaşa Izmir - TURKEY

Tel: +90 (232) 878 91 00 • Fax: +90 (232) 878 91 02

[www.hatsan.com.tr](http://www.hatsan.com.tr) [info@hatsan.com.tr](mailto:info@hatsan.com.tr)



[facebook.com/hatsan.com.tr](https://facebook.com/hatsan.com.tr)



[twitter.com/hatsan\\_arms](https://twitter.com/hatsan_arms)



[youtube.com/hatsanarms](https://youtube.com/hatsanarms)