

# Datasheet - Diamond Series

## 55W, Socket Down



5 Year Warranty

### Specifications

Model	601B-55W
Power Consumption	55 W
Input Voltage	AC100-277V 50-60Hz
CCT*	3000K / 4000K / 5000K
Power Factor	≥0.9
CRI	> 80
Lumen	7150 lm
LED Type	Samsung
LED Quantity	144 LEDs
LED LM80	Yes

\* Other CCTs available upon request.



Samsung LEDs



Rubycon Capacitors



E39/EX39 Base



JAE Connectors

### Dimensions

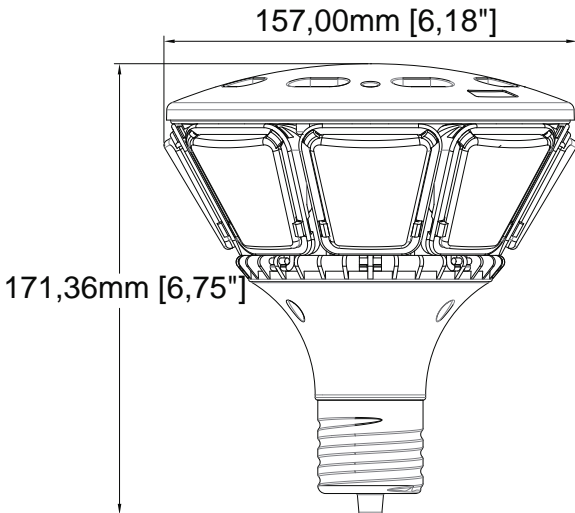

### Beam Spread

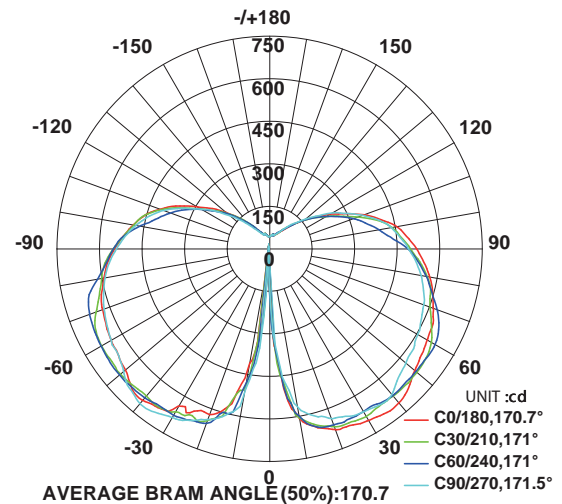

Lifespan of 10 years

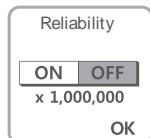

Reliability Test

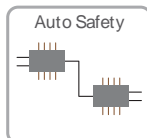

Surge Protection Circuit



Environmentally Friendly

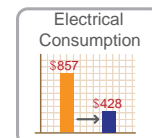

Savings of 87% on Electrical Costs

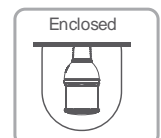

Suitable for Enclosed Fixtures

Datasheet - Diamond Series  
55W, Socket Down



Typical Installation

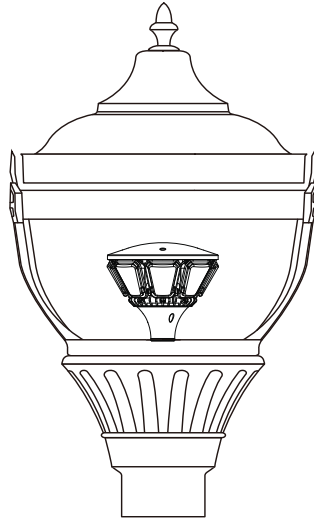

Maximum Rating

Parameter	Rating	Units
Aluminum Heat Sink Temperature	64.9	C
Operating Temperature	-20 ~ +65	C
Storage Temperature	-40 ~ +80	C
Equilibrium Temperature	25	C

Wiring Diagram

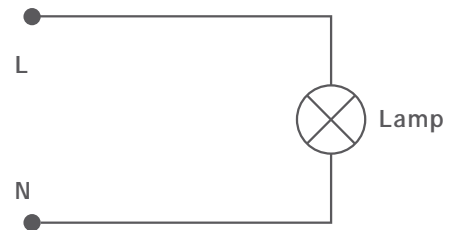

Product Packing Specification

Packing Details	
Pack Quantity	12pcs
Net Weight	2.5 lbs/1150 g
Gross Weight Per CTN	40 lbs/17.92 kg
Box Size	7.68*7.68*7.87" 195 * 195 * 200mm
CTN Size	23.81 * 15.94 * 16.54" 605 * 405 * 420mm

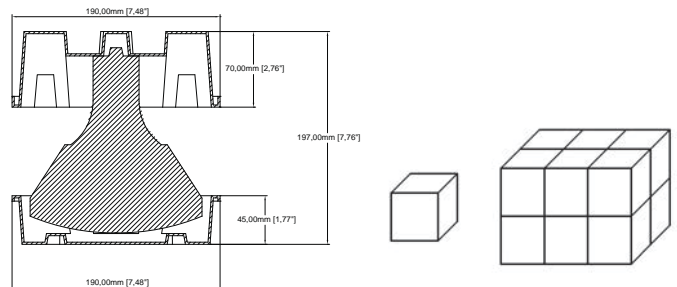

**⚠ CAUTIONS**

- Do not place lamp near flammable materials.
- Please allow lamp to cool before replacing.

**CAO LIGHTING, INC.**  
*LED through Innovation™*

4628 West Skyhawk Drive, West Jordan, UT 84084-4501  
Phone 877.236.4403 Fax 801.256.9287  
customer@caolighting.com  
www.caolighting.com