

Datasheet - Diamond Series

55W, Socket Up



5 Year Warranty



Specifications

Model	601A-55W
Power Consumption	55 W
Input Voltage	AC100-277V 50-60Hz
CCT*	3000K / 4000K / 5000K
Power Factor	≥0.9
CRI	>80
Lumen	7150 lm
LED	Samsung
LED Quantity	180 LEDs
LED LM80	Yes

* Other CCTs available upon request.



Samsung LEDs



Rubycon Capacitors



E39/EX39 Base



JAE Connectors

Dimensions

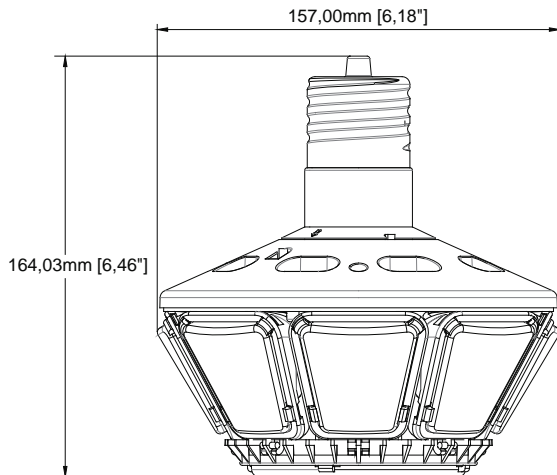

Beam Spread

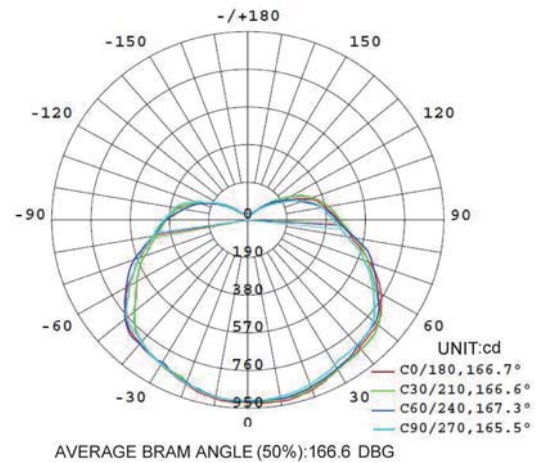

Lifespan of 10 years

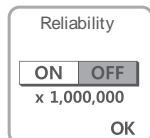

Reliability Test

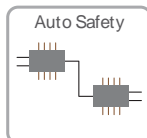

Surge Protection Circuit



Environmentally Friendly

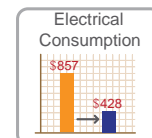

Savings of 87% on Electrical Costs

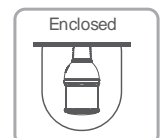

Suitable for Enclosed Fixtures

Datasheet - Diamond Series
55W, Socket Up



Typical Installation

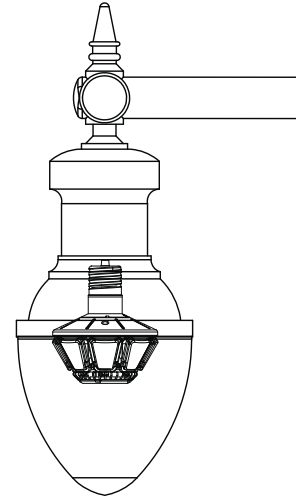
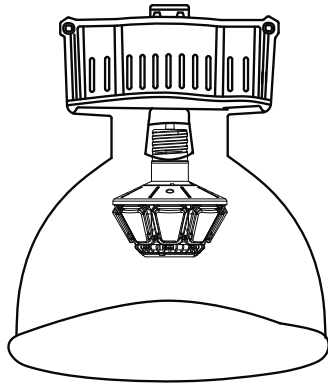

Maximum Rating

Parameter	Rating	Units
Aluminum Heat Sink Temperature	64.9	C
Operating Temperature	-20 ~ +65	C
Storage Temperature	-40 ~ +80	C
Equilibrium Temperature	25	C

Wiring Diagram

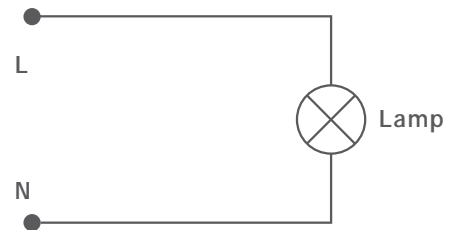

Product Packing Specification

Packing Details	
Pack Quantity	12pcs
Net Weight	2.7 lbs/1240 g
Gross Weight Per CTN	42lbs/18.87 kg
Box Size	10.04*8.66*5.51" 255 * 220 * 140mm
CTN Size	20.87*17.91*17.32" 530 * 455 * 440mm

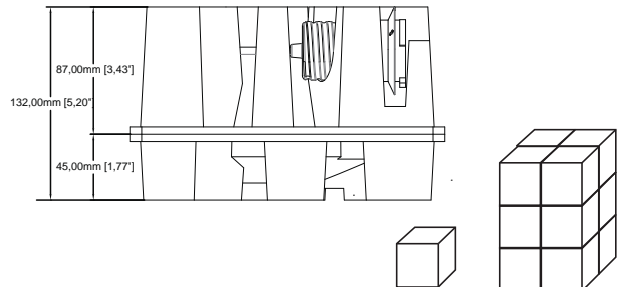

CAUTIONS

- Do not place lamp near flammable materials.
- Please allow lamp to cool before replacing.

CAO LIGHTING, INC.
LED through Innovation™

4628 West Skyhawk Drive, West Jordan, UT 84084-4501
Phone 877.236.4403 Fax 801.256.9287
customer@caolighting.com
www.caolighting.com