

Datasheet - Diamond Series

40W, Socket Up



5 Year Warranty

Specifications

Model	601A-40W
Power Consumption	40 W
Input Voltage	AC100-277V 50-60Hz
CCT*	3000K / 4000K / 5000K
Power Factor	≥0.9
CRI	> 80
Lumen	5200 lm
LED	Samsung
LED Quantity	180 LEDs
LED LM80	Yes

* Other CCTs available upon request.



Samsung LEDs



Rubycon Capacitors



E39/EX39 Base



JAE Connectors

Dimensions

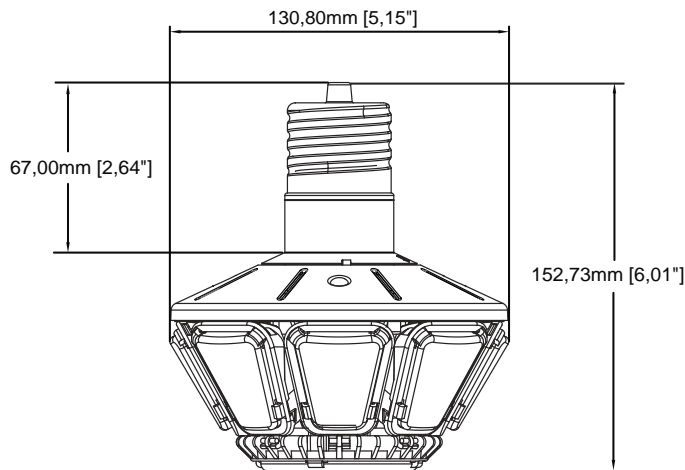

Beam Spread

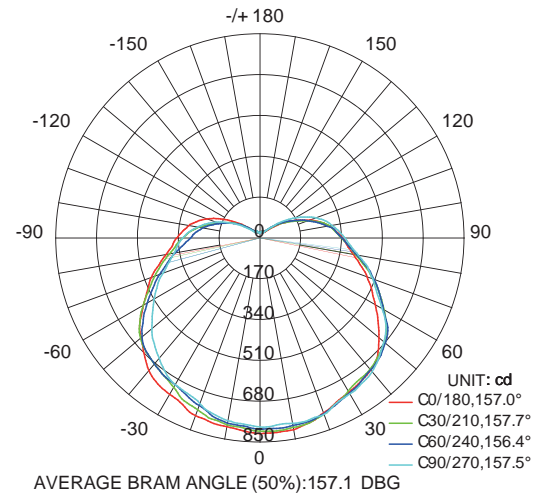

Lifespan of 10 years

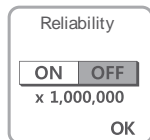

Reliability Test

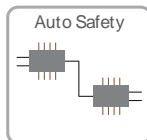

Surge Protection Circuit



Environmentally Friendly

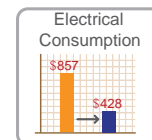

Savings of 87% on Electrical Costs

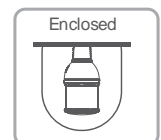

Suitable for Enclosed Fixtures

Datasheet - Diamond Series

40W, Socket Up



Typical Installation

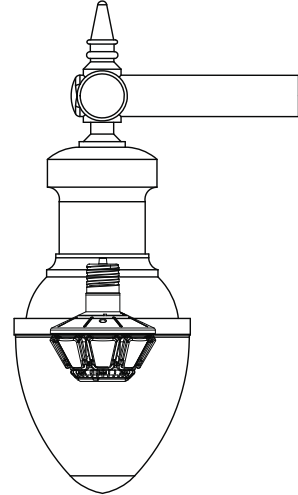
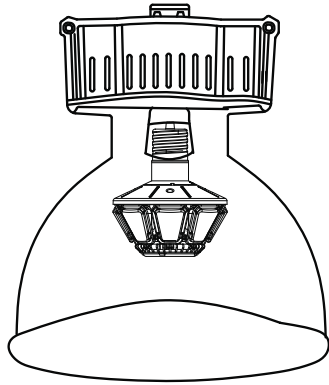

Maximum Rating

Parameter	Rating	Units
Aluminum Heat Sink Temperature	64.9	C
Operating Temperature	-20 ~ +65	C
Storage Temperature	-40 ~ +80	C
Equilibrium Temperature	25	C

Wiring Diagram

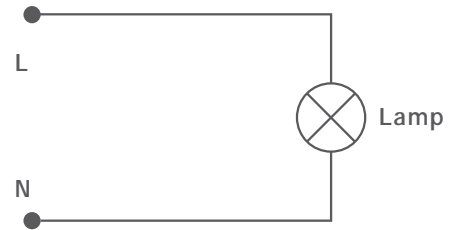

Product Packing Specification

Packing Details	
Pack Quantity	12pcs
Net Weight	1.8lbs/825g
Gross Weight Per CTN	30lbs/13.7kg
Box Size	8.07*6.50*6.18" 205 * 165 * 157mm
CTN Size	20.28*16.93*13.58" 515 * 430 * 345mm

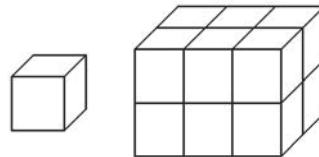
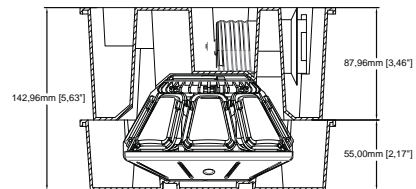

⚠ CAUTIONS

- Do not place lamp near flammable materials.
- Please allow lamp to cool before replacing.

CAO LIGHTING, INC.
LED through Innovation™

4628 West Skyhawk Drive, West Jordan, UT 84084-4501
Phone 877.236.4403 Fax 801.256.9287
customer@caolighting.com
www.caolighting.com