



# Dynasty LED Linear High Bay

902 Series  
 902-100  
 902-100T  
 902-100HV  
 902-100HVT

## FEATURES

- Linear Design
- System Light Efficacy 105 LPW
- Easy Installation & Maintenance
- IP65/ IP30(PIR)
- Five Years Warranty
- ETL, CE, RoHS, CB, WEEE

## TYPICAL APPLICATIONS

- Warehouse/Manufacturing Facilities
- Convention Centers/Sporting Arenas
- Big-Box Retail Stores
- Cold Storage Facilities
- Gymnasiums

## SPECIFICATIONS

### PERFORMANCE

LED Chip	OSRAM
Lumen Output (IES)	10,500 lm
Power Consumption	100 W
Efficacy (IES)	105 lm/W
Efficacy (LED)	131 lm/W
Beam Angle	70/135°, 30/100°, 90°,110°,150°, 60/100°
Color Temperature	4500~5500K (2500~5500K Optional)
CRI	≥80
Lumen Maintenance	L70>70,000 hours (Calculated Using TM-21 Calculator)
Input Voltage	100-277 VAC (347/480 VAC Optional) Dimming Optional
Power Factor	0.95 minimum

### ENVIRONMENTAL

IP Rating	IP65/ IP30(PIR)
Operating Temperature	-30 to 45°C (-22 to 113°F)
Storing Temperature	-40 to 80°C (-40 to 167°F)
Humidity	15% to 95% RH

### PHYSICAL

Dimensions (L×W×H)	650×159×114 mm (25.6×6.3×4.5 in) (Steel Cable)
Weight	4.3 kg (9.5 lbs) (Steel Cable)
Mounting Options	Chain Cable, Surface Mount Chain Mount and Surface Mount
Fixture Material	Aluminum Alloy

### WARRANTY

5 Years

Photometrics

70x135 DEGREE LENS (Forward 5°)

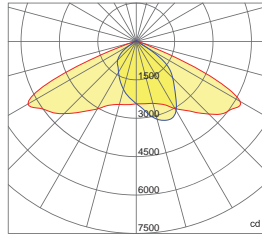

— 0.0~180.0  
— 90.0~270.0

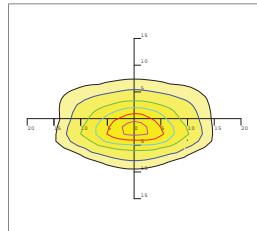

Mounting Height 7m, 0 Tilt,  
50LUX-5LUX

Illumination-70/135 Degree Beaming Angle		
Height	Rectangular Light Spot	LUX
5m	9x24m	90LUX
6m	11x29m	66LUX
7m	13x34m	50LUX
8m	14x39m	39LUX
9m	15x43m	31LUX

Beam Angle (50% max)	70x135 DEG
Field Angle (10%)	100x160 DEG
Luminous Flux (IES)	10,500 lm
Light Efficacy (IES)	105 lm/W
Cutoff Classification	Cutoff

30x100 DEGREE LENS

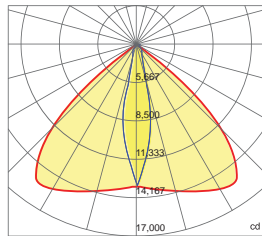

— 0.0~180.0  
— 90.0~270.0

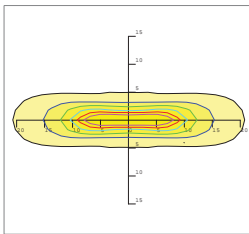

Mounting Height 10m, 0 Tilt,  
50LUX-5LUX

Illumination-30/100 Degree Beaming Angle		
Height	Rectangular Light Spot	LUX
6m	3x11m	231LUX
7m	3x13m	170LUX
8m	4x15m	131LUX
9m	4x17m	104LUX
10m	4x19m	84LUX

Beam Angle (50% max)	30x100 DEG
Field Angle (10%)	50x120 DEG
Luminous Flux (IES)	10,500 lm
Light Efficacy (IES)	105 lm/W
UGR	13/39
Cutoff Classification	Semi-Cutoff

90 DEGREE LENS

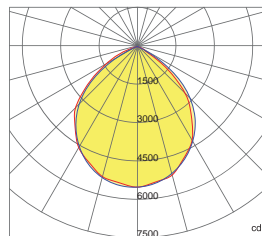

— 0.0~180.0  
— 90.0~270.0

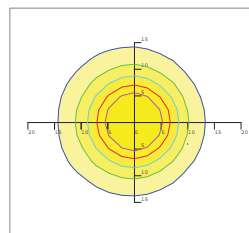

Mounting Height 12m, 0 Tilt,  
50LUX-5LUX

Illumination-90 Degree Beaming Angle		
Height	Beam Diameter	LUX
5m	φ 14m	132LUX
6m	φ 16m	99LUX
7m	φ 19m	76LUX
8m	φ 23m	58LUX
9m	φ 24m	46LUX

Beam Angle (50% max)	90 DEG
Field Angle (10%)	130 DEG
Luminous Flux (IES)	10,500 lm
Light Efficacy (IES)	105 lm/W
UGR	25
Cutoff Classification	Cutoff

Photometrics

110 DEGREE LENS

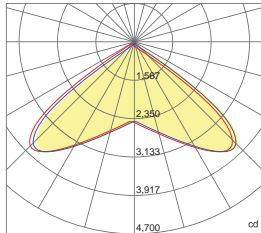

— 0.0~180.0  
— 90.0~270.0

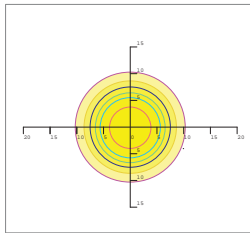

Mounting Height 10m, 0 Tilt,  
50LUX-5LUX

Height	Rectangular Light Spot	LUX
2m	4.0 x 4.3m	595LUX
4m	8.0 x 8.6m	149LUX
6m	12.0 x 13.0m	66LUX
8m	15.9 x 17.3m	37LUX
10m	19.9 x 21.6m	24LUX

Beam Angle (50% max)	110 DEG
Luminous Flux (IES)	10,500 lm
Light Efficacy (IES)	105 lm/W
Cutoff Classification	Cutoff

150 DEGREE LENS

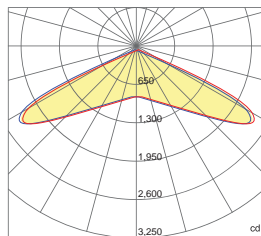

— 0.0~180.0  
— 90.0~270.0

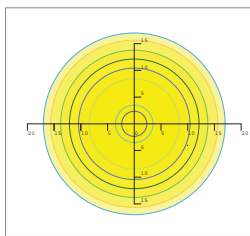

Mounting Height 10m, 0 Tilt,  
50LUX-5LUX

Height	Rectangular Light Spot	LUX
2m	1.8 x 5.3m	303LUX
4m	3.7 x 10.7m	76LUX
6m	5.5 x 16.0m	34LUX
8m	7.4 x 21.4m	19LUX
10m	9.2 x 26.7m	12LUX

Beam Angle (50% max)	150 DEG
Luminous Flux (IES)	10,500 lm
Light Efficacy (IES)	105 lm/W
Cutoff Classification	Cutoff

60 x 100 DEGREE LENS

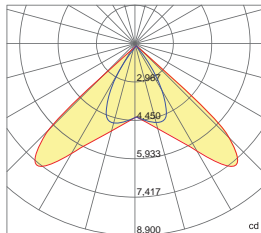

— 0.0~180.0  
— 90.0~270.0

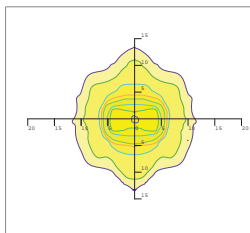

Mounting Height 10m, 0 Tilt,  
50LUX-5LUX

Height	Rectangular Light Spot	LUX
2m	1.5 x 2.2m	986LUX
4m	2.9 x 4.4m	246LUX
6m	4.4 x 6.6m	110LUX
8m	5.8 x 8.7m	62LUX
10m	7.3 x 10.9m	40LUX

Beam Angle (50% max)	60x100 DEG
Luminous Flux (IES)	10,500 lm
Light Efficacy (IES)	105 lm/W
Cutoff Classification	Cutoff

# Microwave Sensor & Dimmer Option



Technical Data			
Operating voltage	120-277V	Standby power	approx. 0.5W
Switched power	Max.capacitive load: 800W @277V, 400W@120V	Heating time	20s
Detection area	10/50/75/100%, can be customized	Sensor principle	Microwave motion
Hold time	5S/30S/1min/5min/10min/20min/30min, can be customized	Microwave frequency	5.8GHz+/-75MHz
Standby period	0s/10s/1min/5min/10min/30min/1h/+∞ can be customized	Microwave power	<0.2mw
Standby dimming level	10%/20%/30%/50% can be customized	Detection range	Max. (φxH):18m x 10m
Daylight threshold	2~50lux daylight/twilight/darkness, can be customized	Detection angle	30° ~ 150°
Operating temperature	-35°C ~ +70°C	Mounting height	Max.10m
IP rating	IP20, IP65(mounting in Hytronik special box)	Certificate	ETL, FCC

## Detection Pattern

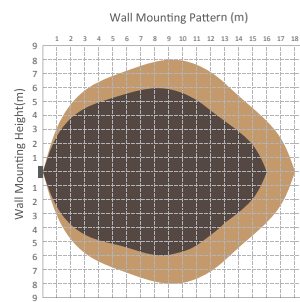
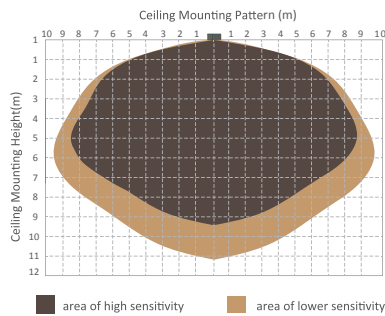

## Setting

	Detection Area			Hold-time				Daylight Sensor			Stand-by Period (Corridor function)			Stand-by Dimming Level			
	1	2		1	2	3		1	2		1	2	3		1	2	
I	●	●	100%	●	●	●	5s	●	●	Disable	●	●	●	0s	●	●	10%
II	●	○	75%	●	●	○	30s	●	○	50lux	●	●	○	10s	●	○	20%
III	○	●	50%	●	○	●	1min	○	●	10lux	●	○	●	1min	○	●	30%
IV	○	○	10%	●	○	○	5min	○	○	2lux	●	○	●	5min	○	○	50%
V				○	●	●	10min				○	●	●	10min			
VI				○	●	○	20min				○	●	○	30min			
VII				○	○	○	30min				○	○	●	1h			
VIII											○	○	○	+∞			

- Detection area can be reduced by selecting the combination on the DIP switches to fit precisely for each specific application.
- Hold-time means the time period you would like to keep the lamp on 100% after the person has left the detection area.
- The daylight threshold can be set on DIP switches, to fit for particular application.
- This is the time period you would like to keep at the low light output level before it is completely switched off in the long absence of people. Note: 0 means on/off control; +∞ means 2 steps of dimming control, fixture never switch off.
- This is the dimmed low light output level you would like to have after the hold-time in the absence of people.

# PIR Sensor Option

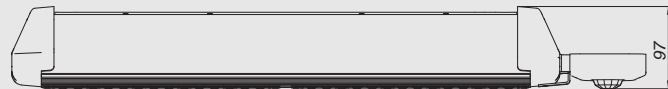
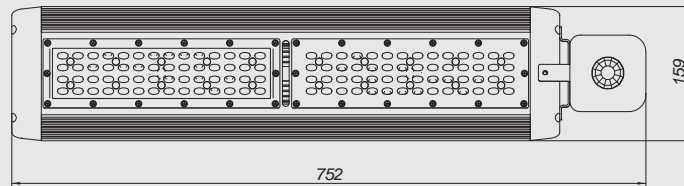
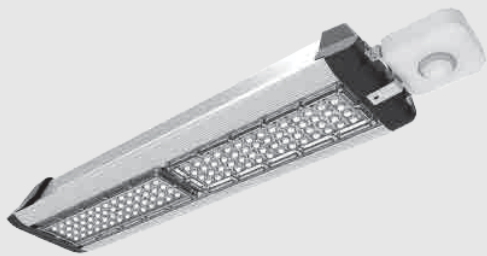

Input Voltage	AC 120-277 V, 60HZ
Load Requirement	800VA @ 120V AC Fluorescent Ballasts NO Min 1200VA @ 277V AC Fluorescent Ballasts NO Min
Load Horsepower	1/6HP
Time Delay Adjustment	Fixed 15 seconds to 30 minutes
Operating Temperature	32° to 131° F ( 0° to 55° C )
Humidity range	0%-90%RH, non-condensing
Coverage range	Up to 30 ft mounting / 360 Degrees
Terminal Line	Black-Hot, White-Neutral, Red-Load
Warranty	2 Years
IP Rating	IP 30
Sensor Type	IR Sensor



Mounting Options

Chain Cable

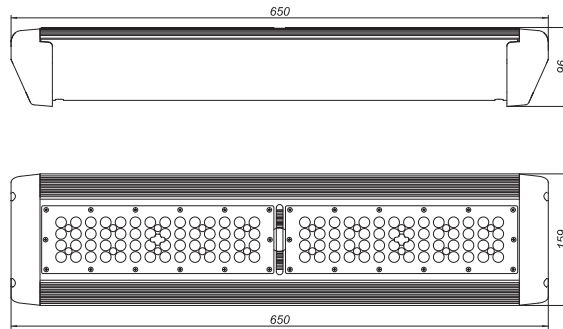

Surface Mount Bracket

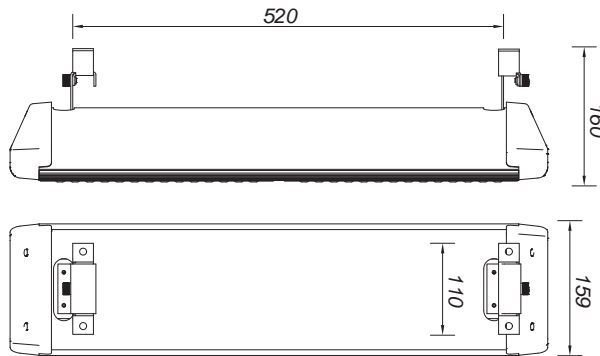

Chain Mount and Surface Mount

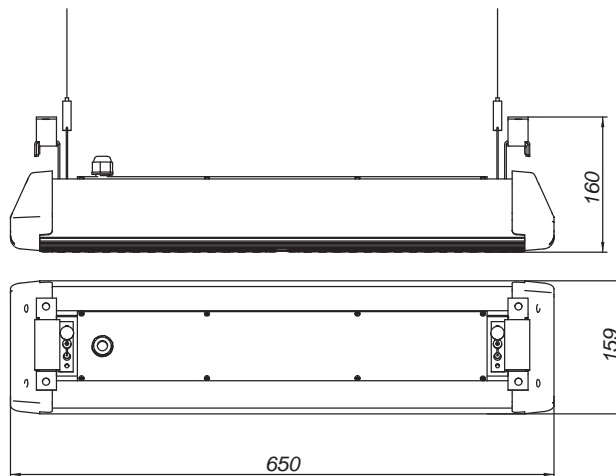

**CAO LIGHTING, INC.**  
LED through Innovation™

4628 West Skyhawk Drive, West Jordan, UT 84084-4501  
Phone 877.236.4403 Fax 801.256.9287  
customer@caolighting.com  
www.caolighting.com

