









Warnings and Cautions

Warning 	Dangerous Voltage Warning: warns of situations in which a high voltage can cause injury and/or equipment damage. The text next to this symbol describes ways to avoid danger.
Warning 	General Warning: warns of situations that can cause physical injury and/or equipment damage by means other than electrical. The text next to this symbol describes ways to avoid the danger.

General Safety Instructions

Warning 	Be sure to read, understand, and follow all safety instructions.
Warning 	Only qualified electricians should carry out all electrical installation and maintenance work on V1k drive output filters.
Warning 	All wiring must be in accordance with the National Electrical Code (NEC) and/or any other codes that apply to the installation site.
Warning 	Disconnect all power before working on the equipment. Do not attempt any work on a powered V1k output filter.
Warning 	The V1k, VFD, motor, and other connected equipment must be properly grounded.
Warning 	The VFD terminals and connected cables are at a dangerously high voltage when power is applied to the VFD, regardless of motor operation.

All electrical connections must be re-torqued annually.

Field Wiring

Field Wiring Connection Terminals

Compression type terminals are provided for all line wiring connections. The wire size capacity ranges and tightening torque for the power terminals are listed in the table.

V1k Model Numbers	Input and Output Motor Power	
	Wire Size	Torque (in.-lb.)
V1k2A to V1k12A	12 - 14	10
V1k16A	4 - 12	20
V1k18A to V1k21A	4 - 10	20
V1k25A to V1k27A	4 - 8	20
V1k35A	6 - 8	30
V1k45A	6	30
V1k55A	1 - 4	35
V1k80A	1 - 3	35
V1k110A	2/0 - 1/0	50
V1k130A	2/0	50
V1k160A	250 MCM - 3/0	375
V1k200A	two 2/0 - 1	50
V1k250A	two 2/0	50
V1k305A	two 350 MCM - 3/0	375
V1k362A	two 350 MCM - 4/0	375
V1k420A	two 600 MCM - 300	500
V1k480A	two 600 MCM - 350	500
V1k600A	two 600 MCM - 500 MCM	500
V1k750A	three 600 MCM - 400 MCM	500

See www.transcoil.com for dimensions tables. Please contact TCI Technical Support or your TCI distributor for application information regarding the use of V1k output filters on the output side of the VFD.

TCI, LLC
W132 N10611 Grant Drive
Germantown, Wisconsin 53022
Ph: 800-TCI-8282
www.transcoil.com



V1k Installation Guide

TCI, LLC
W132 N10611 Grant Drive
Germantown, Wisconsin 53022
Ph: 800-TCI-8282
www.transcoil.com

V1k KLC-Series Motor Protection Filter Installation Instructions

Installation Checklist

- Make sure that the installation location will not be exposed to direct sunlight, rain or dripping liquids, corrosive liquids or gases, explosive or combustible gases or dust, excessive airbourne dirt and dust, or excessive vibration.
- Select a mounting area that will allow adequate cooling air and maintenance access.
- Make sure that all wiring conforms to the requirements of the National Electric Code (NEC) and/or other applicable electrical codes.
- Ground the V1k Ouput Filter to a dedicated system ground to ensure safety and filter performance. Use a properly sized grounding conductor.
- Wire the output power terminals of the VFD, T1(U), T2(V), & T3(W) to the input terminals of the V1k, A1, B1 & C1.
- Wire the output power terminals, of the V1k, A2, B2 & C2 to the motor power connections.
- Make sure the VFD is set for operating modes and ranges that are compatible with the V1k Output Filter.
- Check the entire system throughly before energizing and operating any equipment.

When you receive the unit, you should immediately inspect the shipping container and report any damage to the shipping carrier who delivered the unit.

Verify the Application

Make sure the V1k drive output filter is correct for the application. The current rating of the V1k should be sized to handle the FLA rating of the motor but not to exceed 110% of the drive output current rating. This output filter is best applied matched closely to the load. The V1k drive output filter is not selected by the drive input current rating. Properly sized and applied, TCI guarantees that the V1k will limit motor terminal peak input vottage to 150% of the bus voltage with a wire lead length of 1000 feet and a carrier frequency of 4kHz. Maximum lead length and carrier frequency can vary depending on wire lead type. For best performance, the V1k should be installed within 10 feet of the drive.

Variable Frequency Drive Settings

Make sure that the variable frequency drive will be set for operation modes and ranges that are compatible with the V1k output filter:

- Maximum output frequency: 60 Hz
- PWM switching frequency best between 2kHz and 4kHz
- Mode of operation: Do not use with DC braking unless the drive application has been confirmed by TCI Technical Support
- Do not use on overhauling loads without bus voltage control.

Mounting and open panel unit

If you are mounting an open panel unit in your own enclosure, you must provide an enclosure that is adequately sized and ventilated sufficiently to prevent overheating. The filter is designed with a maximum ambient temperature of 40° C (104°F). If the ambient temperature exceeds this value it is the responsibility of the customer to provide auxiliary cooling to reduce the ambient operating temperature around the V1k filter. TCI strongly recommends using auxiliary cooling devices such as cooling fans, heat exchangers, or possibly air conditioning units when required to maintain the proper operating temperature.

The V1k must be mounted vertically on a smooth, solid surface, free from heat, dampness, and condensation. Mounting it vertically is important for natural convection cooling. A metal plate is provided to mount the V1k on a composite surface.

Power Wiring

The conduit and wiring from the output of the variable frequency drive to the motor must be routed to the V1k and then to the motor. TCI recommends a separate dedicated conduit run for each drive/filter/ motor run unless properly shielded and segregated wiring procedures are practiced. Parasitic and induced capacitance can greatly reduce the effectiveness of the filter performance. Under no circumstances should you wire both control and power wire in the same conduit unless the wire way is specifically designed for this practice. The line reactor temperature is sensitive to lead wire oversizing. **Avoid lead wires more than five times oversized by copper cross sectional area regardless of the material used.** Use 75°C copper conductors only or the equivalent, unless the wire connector is marked for Al/Cu, then the use of aluminum wire is permitted. Use only copper conductor on units rated above 80 amps.

Wiring Cable Entry Locations

TCI has provided enclosure knock-outs on the two smaller enclosures for incoming and outgoing power cables. These are located in a typical wiring location for customer convenience. On the two larger size enclosures, TCI has not provided knock-outs due to the wide variety of application requirements. TCI allows installing electricians the option of locating the cable openings at a point of their choosing.

Grounding

The V1k filter must be connected to the ground of the premises wiring system. This can be conducted by identifying a known premises ground near by the filter or running a special ground dedicated for the application. The ground connection must be made using a wire conductor. Metallic conduit is not a suitable grounding conductor. The integrity of all ground connections should be periodically checked.

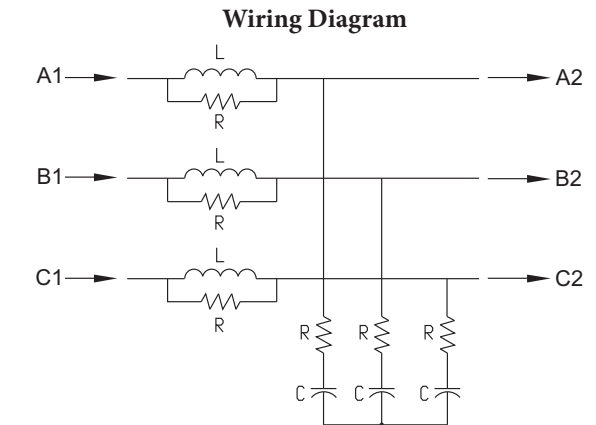

Product Specifications

- Current Rating: 2 - 750 Amps, 240 V - 600 V, 7.5 - 600 HP
- cUL
- Open, UL Type 1 and 3R Enclosures
- Efficiency > 98%
- Insulation Rating: 600V Class
- Insulation Class: Class H (180°C or better)
- Maximum Altitude: 2000 m (6,000 ft) Derating necessary above 2000 m
- Lead Length: Specific applications can reach 3,000 feet (consult factory for applications above 1,500 feet)
- Ambient Temp: Max 40°C