

SACRÉD BUNDLE

LUXE ESSENTIALS | FOR YOUR MINI

Myla Teak Buffet

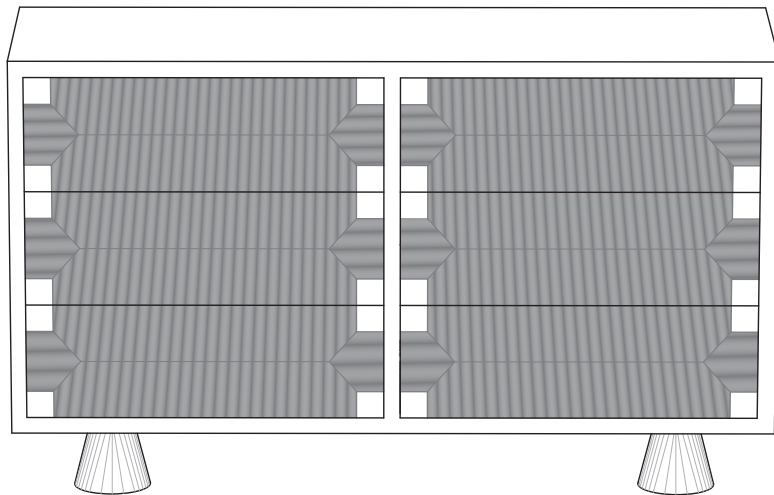

IMPORTANT
PLEASE READ THE INSTRUCTIONS
CAREFULLY AND KEEP FOR FUTURE
REFERENCE

ML10011



WARNING! Serious or fatal crushing injuries can occur from furniture tip over. To prevent tip over, this furniture must be used with the wall attachment device(s) provided. Screw(s) and plug(s) for the wall are not included. Use screw(s) and plug(s) suitable for the walls in your home. If you are uncertain, seek professional advice. Read and follow each step of the instruction of the anchor kit carefully.

What causes tip-overs?

Some causes are illustrated below. Also remember that an uneven or sloped floor, edge of a carpet or rug, as well as soft or thick carpets can also cause instability and tipping accidents.

When we develop furniture, we do everything we can to make it as stable and safe as possible. But we can't out-smart the laws of physics. Like the fact that when the centre of gravity of a piece of furniture shifts outside the base of the furniture, it will tip over if it is not secured. Or the fact that a pulled-out drawer works like a lever.

Opening several drawers at the same time in search of something. This makes the centre of gravity of the chest of drawers shift outside the base of the furniture and it tips over.

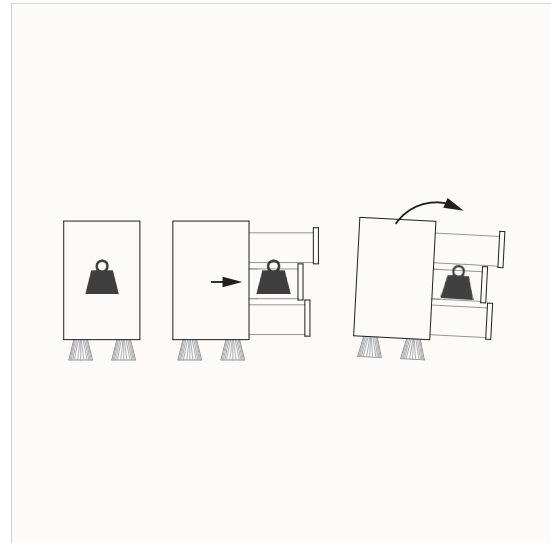
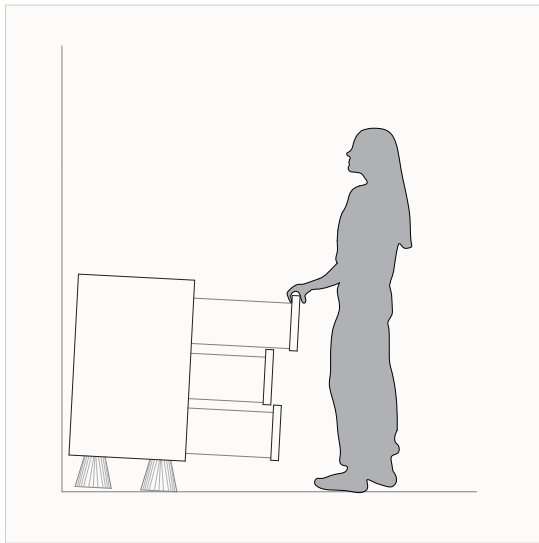

Using the drawers as a ladder to reach an object. Putting a toy or some other attraction on top could tempt a child to climb up. Putting a heavy object on top of a chest of drawers increases the tip-over hazard. Tipping may also occur if a toddler sits in a drawer for play or opens all drawers out of curiosity.

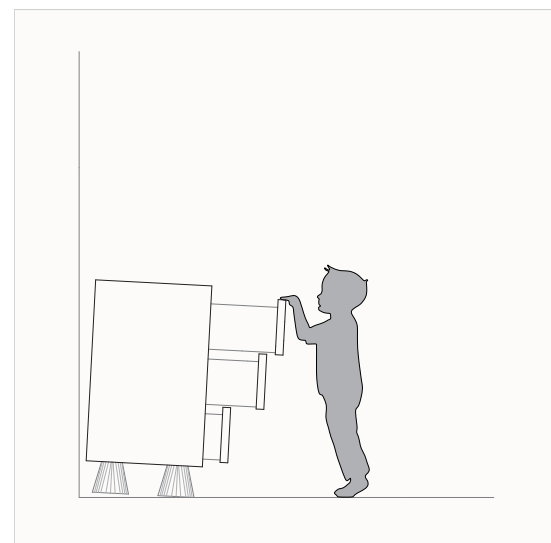
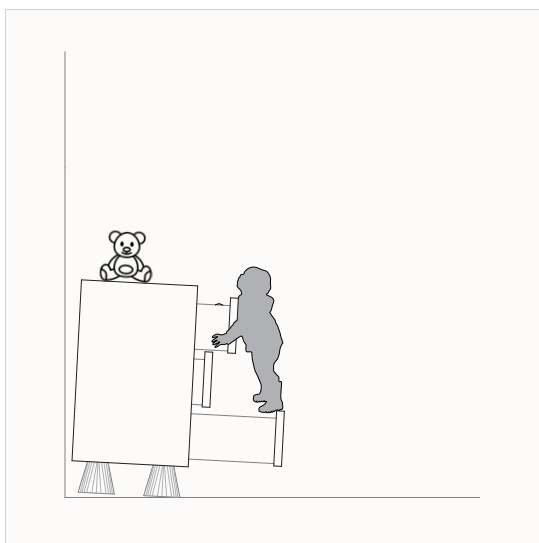

FURNITURE MUST BE PERMANENTLY ATTACHED TO THE WALL USING THE ATTACHMENT PROVIDED

Sacred Bundle Pty Ltd. ABN 47631902479
5/108 Dover Drive, Burleigh Heads, QLD, 4220.
Phone: +61 4 34362219
+61 4 23688138
Email: bubinfo@sacredbundle.com.au
www.sacredbundle.com.au

Myla Teak Buffet - ML10011

Assembled Dimensions
1400L x 450D x 850H mm

Materials: Natural Teak/ Rattan

Parts List

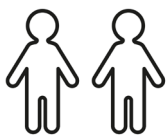
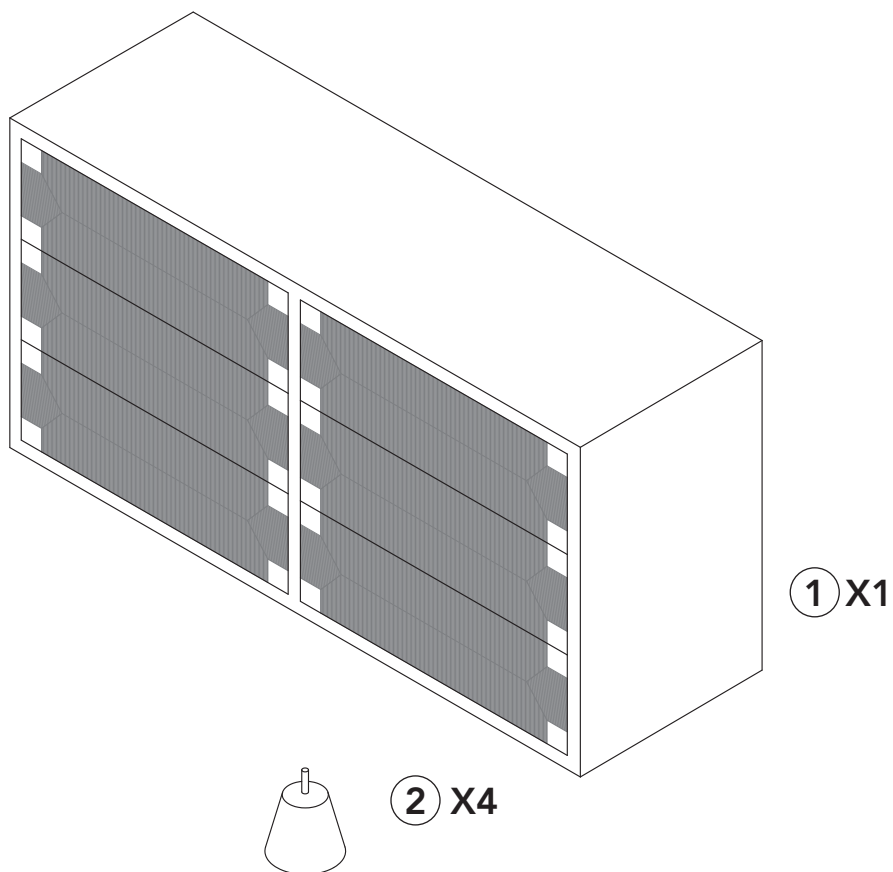

2 Adults Required for
Assembly

Assembly

1

Place main unit upside down on a soft surface.

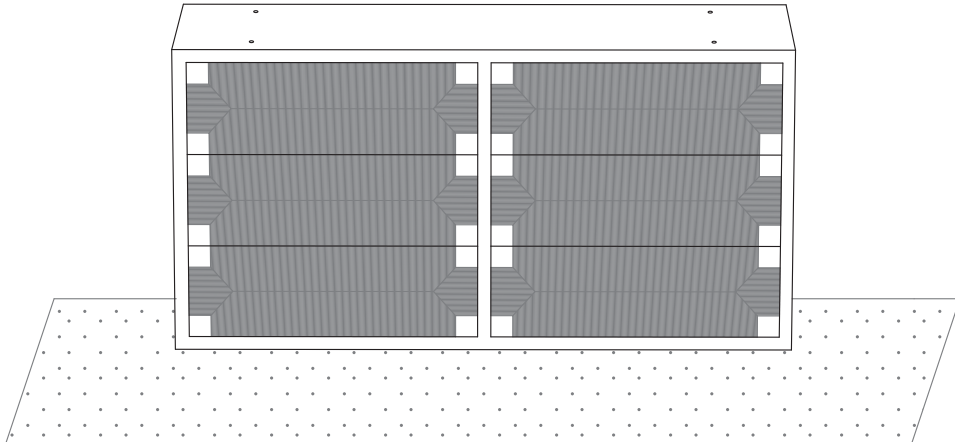

2

Screw both legs to the base by matching the numbered stickers. Turn buffet upright once assembled.

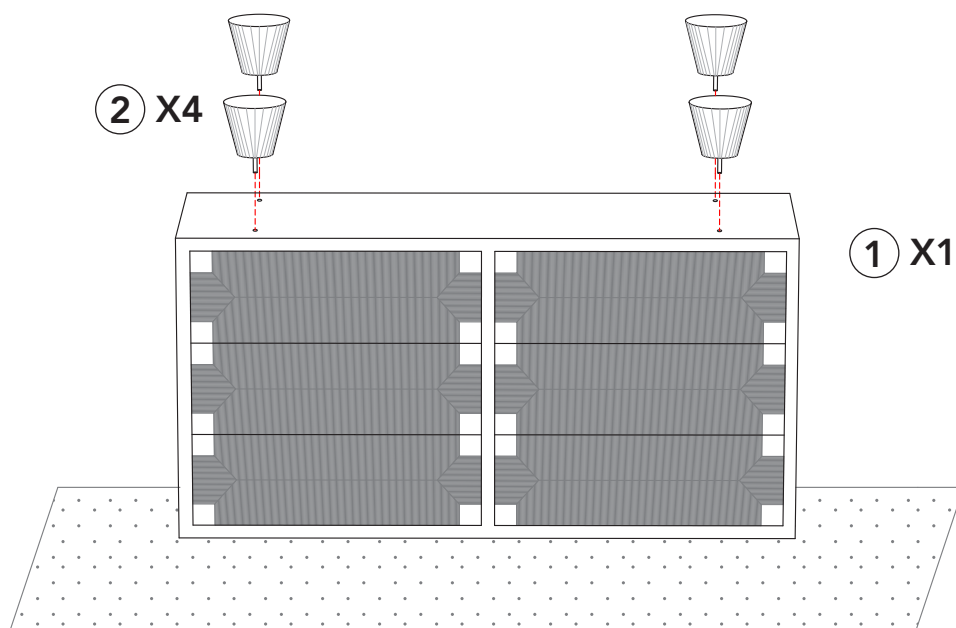

Assembly

3

Install Wall Anchors. Anchors must be placed on both sides of the buffet. Please refer to instructions provided with the anchor kit for correct installation.

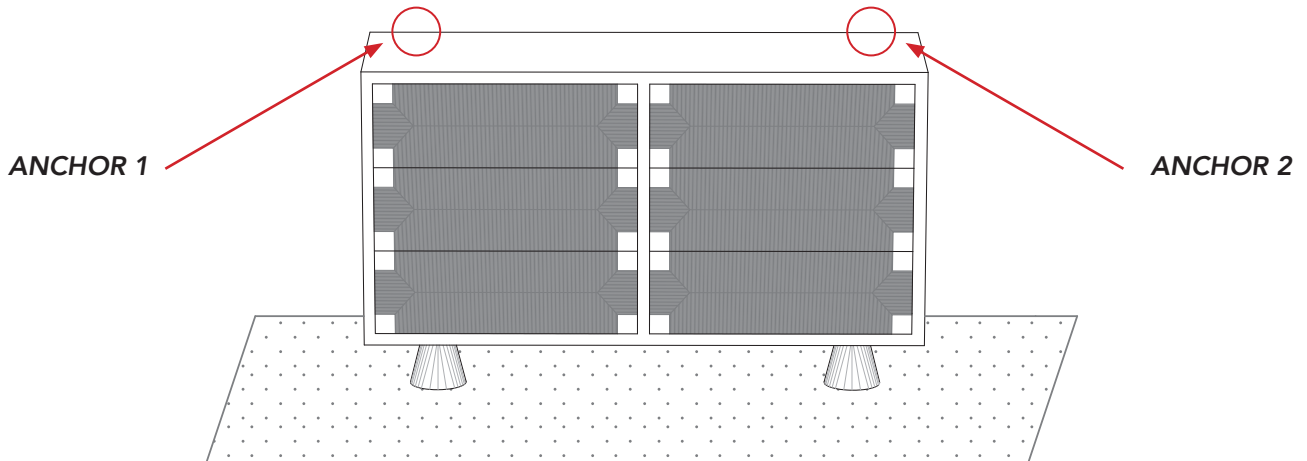

**FURNITURE MUST BE PERMANENTLY ATTACHED
TO THE WALL USING THE ATTACHMENT PROVIDED**

CARE & MAINTENANCE

Congratulations and thank you for choosing Sacred Bundle product(s). The furniture you have purchased is constructed from high quality materials for strength and durability. Here are some tips on how you can preserve its beauty for a long time.

1. Do not expose furniture to direct heat sources, extreme changes in temperature or moisture. The buffet should not be placed directly next to air-conditioning, outlets, fire places, radiators, space heaters, humidifiers, or dehumidifiers. Exposure to extreme variations of temperature and humidity can damage wood products.
2. Keep the buffet out of direct sunlight. UV rays may fade colours and in some cases darken them. It can cause crazing or hair line cracks in the finish. Finishes will darken naturally over time and exposure to direct sunlight will hasten this natural process along with some wood darkening; this is not considered to be a quality defect.
3. Wipe up spills immediately with a soft, clean cloth.
4. Urine spills on furniture can cause discolouration.
5. Clean furniture by wiping the surface with a soft cloth dampened with water.
6. If necessary clean furniture using a mild soap solution and wipe clean with a soft cloth dampened with water and then dry with soft clean cloth.
7. Do not use strong household cleaners.
8. Always wipe in the direction of the grain in the wood do not wipe in a circular motion.
9. Avoid contact with sharp objects, or containers containing hot liquid.
10. When moving furniture do not drag always lift and place in position.
11. To remove any residue from assembly stickers, wipe off gently with a small amount of rubbing alcohol on a clean cloth.
12. In case of the appearance of mildew after storage, generously spray all affected areas with a mix of 1:10 part vinegar and water. Once the mix has been applied, let it sit for 10 minutes and wipe clean with a dry cloth. Place the affected parts outside in direct sunlight for 1 hour to air out and allow it to thoroughly dry.