

Miele

Operating instructions

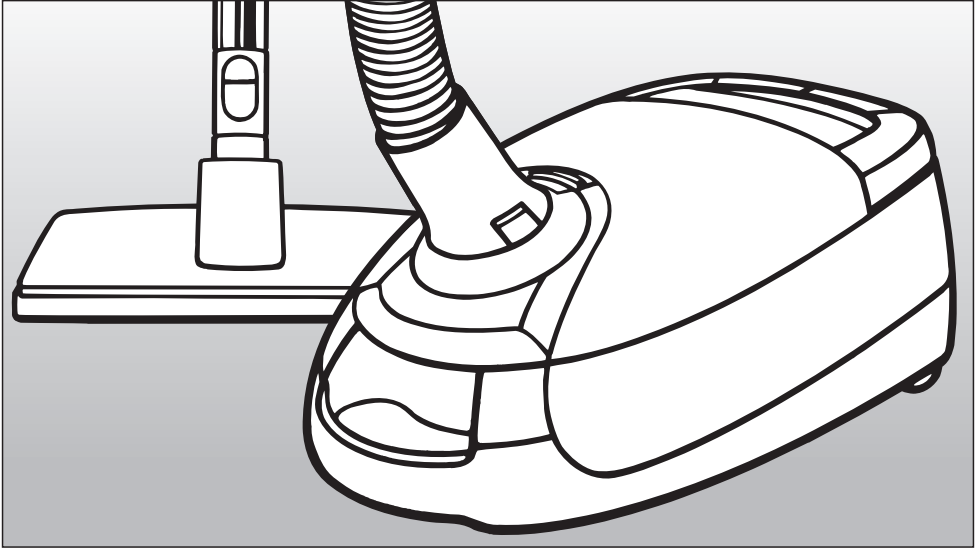

Vacuum cleaner S 5000

To prevent accidents
and machine damage,
read these instructions
before installation and use.

HS11

en - US, CA

M.-Nr. 07 176 490

IMPORTANT SAFETY INSTRUCTIONS	4
Guide to the vacuum cleaner	8
Before using the vacuum cleaner	10
Included accessories	13
Use	16
Power cord	16
Turning the vacuum On and Off	16
Adjusting the suction	18
Opening the air inlet valve	20
Transport and storage	21
Maintenance and care	23
Purchasing new dustbags and filters	23
Which dustbags and filters are the right ones?	23
When to change the dustbag	24
How to change the dustbag	25
When to change the exhaust filter	26
Exhaust filter change indicator	27
Replacing the "Super Air Clean" filter	28
Replacing the "Active Air Clean" filter and the "Active HEPA" filter	29
Exchanging Exhaust Filters	30
When to change the dust compartment filter	31
How to change the exhaust filter	31
When to change the thread catcher	32
Maintenance and care	33
Frequently asked questions	34
Technical Service	35
Optional accessories	36
Caring for the environment	43

IMPORTANT SAFETY INSTRUCTIONS

When using an electrical appliance, basic precautions should always be followed, including the following:

READ ALL INSTRUCTIONS BEFORE USING THIS APPLIANCE

The manufacturer cannot be held responsible for any damage caused by non-compliance of these Important Safety Instructions.

WARNING-

To reduce the risk of fire, electric shock or injury:

Before using

▶ Check the voltage rating of the vacuum cleaner before connecting the power cord to an electrical outlet. Your power source should correspond with the voltage rating plate located on the underside of the vacuum. Use only household AC outlets. Never use DC power sources. If you are not sure of your home's voltage supply, consult a qualified electrician. Connecting the vacuum cleaner to a higher voltage than indicated in these instructions may result in damage to the vacuum cleaner or injury.

▶ To reduce the risk of electric shock, this appliance has a polarized plug (one blade is wider than the other.) This plug will fit in a polarized outlet only one way. If the plug does not fit fully in the outlet, reverse the plug. If it still does not fit, contact a qualified electrician to install the proper outlet. Do not alter the plug in any way.

▶ A damaged vacuum cleaner can be dangerous. Check the packaging, vacuum cleaner and accessories for any signs of damage. Do not use a damaged appliance.

▶ Do not use with a damaged cord or plug. If the appliance is not working as it should, has been dropped, damaged, left outdoors or submerged in water, bring it to a service center.

▶ The electrical outlet must be fitted with a 15 A fuse.

IMPORTANT SAFETY INSTRUCTIONS

Use

- ▶ Do not use on people or animals.
- ▶ Do not use outdoors or on wet surfaces. Only **dry** surfaces should be vacuumed.
- ▶ Use only as described in this manual. Use only Miele recommended accessories.
- ▶ The manufacturer cannot be held responsible for damage caused by non-compliance with these Important Safety Instructions. This appliance is intended strictly for household use only.
- ▶ Do not allow the vacuum cleaner to be used as a toy. Close attention is necessary when used near children.
- ▶ Never use the vacuum cleaner without the dustbag or filters in place. Otherwise it could be damaged.
- ▶ If a dustbag is not inserted, the dust compartment lid will not close. Do not force it shut.
- ▶ Do not leave the vacuum plugged in. Unplug it from the outlet when not in use and before servicing.
- ▶ On the underside of the vacuum handpiece is a metal insert designed to absorb static electricity. Please make certain that your hand remains around this metal insert when vacuuming.
- ▶ Persons which lack physical, sensory or mental abilities or experience with the machine should not use it without supervision or instruction by a responsible person.
- ▶ Unwind the cord completely to aid the vacuum in dissipating heat.
- ▶ This vacuum should not be used to entrap or retain any hazardous materials.
- ▶ Do not use the vacuum cleaner to pick up liquids or damp dirt. This could impair the electrical safety of the vacuum cleaner. Wait for freshly shampooed carpets to dry.
- ▶ Do not vacuum anything that is burning or smoking such as cigarettes, matches or hot ashes. The vacuum could catch fire.
- ▶ Do not vacuum toner dust. Toner, such as that used in printers and photocopiers can conduct electricity.
- ▶ Do not use to pick up any flammable or combustible liquids, such as gasoline, or use in areas where they may be present.
- ▶ Do not vacuum up items which are heavy, hard or have sharp edges. They could cause a blockage and damage the appliance.
- ▶ Do not pull or carry by the cord, use the cord as a handle, close a door on the cord, or pull the cord around sharp edges or corners. Do not run the appliance over the cord. Keep the cord away from heated surfaces.

IMPORTANT SAFETY INSTRUCTIONS

▶ Do not unplug by pulling on the cord. To unplug, grasp the plug, not the cord.

▶ Do not handle the plug or vacuum with wet hands.

▶ Keep the power cord, hair, loose clothing, fingers and all parts of the body away from openings and moving parts.

▶ Do not place anything into the openings of the vacuum. Do not use if any openings are blocked; keep them free of dust, lint, hair, or anything that may reduce air flow.

▶ This appliance is equipped with a power cord reel. Hold plug when rewinding onto cord reel. Do not allow plug to whip when rewinding.

▶ Turn off all controls before unplugging.

▶ Use extra care when cleaning on stairs.

▶ Floor attachments, accessories and wands must not be used at head level to avoid injury to eyes and ears.

▶ Monitor the dustbag change indicator and inspect all filters regularly. For best performance, the dustbag and filters should be replaced when necessary. A full bag or blocked filter will reduce the vacuum cleaner's suction power. A temperature limiter automatically switches the vacuum cleaner off if it gets too hot, see "Frequently asked questions".

Using accessories

▶ The hose and the telescopic wand contain electrical wires. Do not use the vacuum cleaner if these parts are damaged, cut or punctured. Avoid picking up sharp objects. Danger of electric shock!

▶ Unplug the vacuum when changing accessories, especially the Turbobrush, and Powerbrush.

▶ To avoid the risk of injury when vacuuming with a Miele Power or Turbobrush do not touch the rotating roller brush. Danger of injury.

IMPORTANT SAFETY INSTRUCTIONS

▶ The socket on the vacuum cleaner (depending on model) must only be used for the Miele Powerbrush specified for use with this appliance.

▶ Danger of injury. The Miele Powerbrush is a motor driven accessory for use only with Miele vacuum cleaners. The vacuum must not be used with another manufacturer's powerbrush.

▶ Do not use the vacuum without an accessory attached. The rim could be damaged and injuries could result from sharp edges.

▶ Miele dust bags are disposable and intended to be used only once. Do not attempt to reuse them. An over stuffed dustbag will reduce the efficiency of the vacuum cleaner.

▶ Only use genuine Miele dustbags with the Miele quality signet and original Miele filters and accessories. Only then will the manufacturer guarantee its safety.

Cleaning, maintenance and repairs

▶ Turn the vacuum cleaner off after each use and before every cleaning / maintenance. Pull the plug from the outlet.

▶ Never submerge the vacuum cleaner in water. Clean only with a dry cloth or slightly damp cloth when disconnected from the mains supply. If moisture gets into the appliance there is a risk of electric shock.

▶ The electro-suction hose and the telescopic wand contain electrical wires. The plug connectors must not come in contact with water. These items may only be cleaned with a dry cloth, no moisture can touch them. Danger of electric shock.

▶ Repairs may only be performed by an authorized service agent in accordance with national and local safety regulations. Unauthorized repairs could cause injury or machine damage. The manufacturer cannot be held responsible for unauthorized work.

▶ If the power cord is damaged it should be replaced along with a new cable reel by Miele Technical Service.

Disposing of an old appliance

▶ Before discarding an old vacuum cleaner, please cut off the power cord and render the plug useless. Ensure the appliance presents no danger to children while being stored for disposal.

SAVE THESE INSTRUCTIONS

Guide to the vacuum cleaner

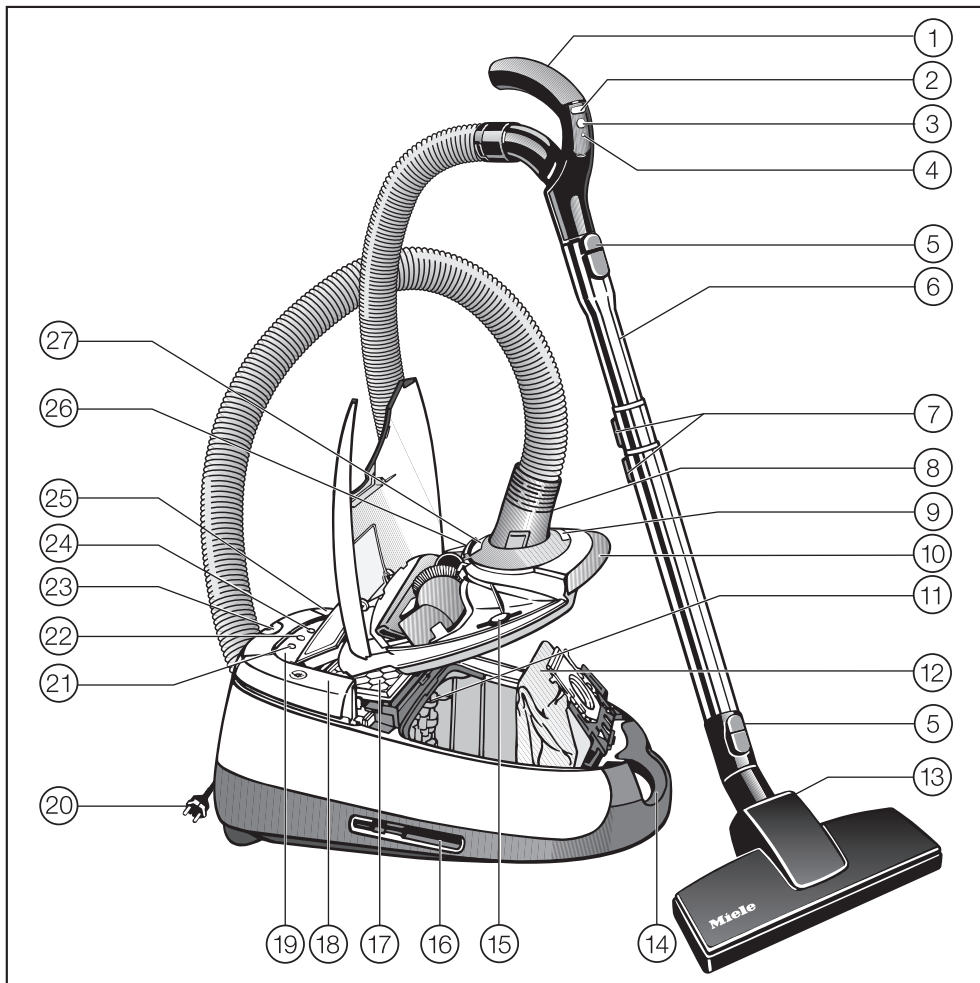

Some models come standard with one of the following accessories, which are not shown in this figure. A separate Operating manual of the respective accessory is supplied with the vacuum.

- Powerbrush
- Turbobrush

Guide to the vacuum cleaner

- ① Handpiece (depending on model) *
- ② Suction power buttons + / - *
- ③ Standby button for vacuum pauses *
- ④ LED *
- ⑤ Locking button
- ⑥ Telescopic wand *
- ⑦ Telescopic wand release button *
- ⑧ Elbow
- ⑨ Powerbrush outlet*
- ⑩ Dust compartment lid release
- ⑪ Dust compartment filter (motor protection)
- ⑫ Dust bag
- ⑬ Floor tool *
- ⑭ Carrying handle
- ⑮ Fastener for the Powerbrush outlet cap
- ⑯ Park-System (on both sides of the vacuum)
- ⑰ Exhaust filter *
- ⑱ Foot switch for cord rewind
- ⑲ Suction power selector *
- ⑳ Power cord with plug
- ㉑ Exhaust filter change indicator (Reset button) *
- ㉒ Thermo indicator  *
- ㉓ Park-System
- ㉔ Standby indicator *
- ㉕ Foot switch On/Off ①
- ㉖ Accessory compartment lid release
- ㉗ Airflow indicator

The features marked * may vary or not be available on your model.

Before using the vacuum cleaner

Attaching the suction hose

- Insert the elbow into the suction socket until it clicks. Use the inlet guides to direct insertion.

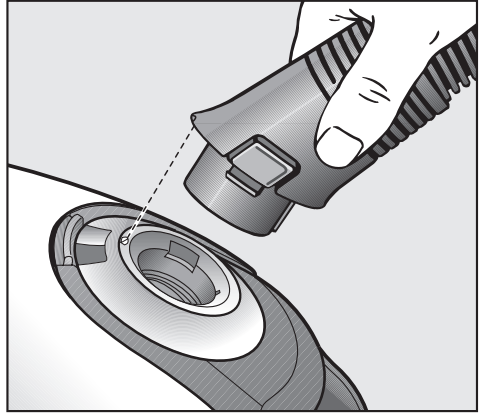

Removing the suction hose

- Press the release buttons at the sides of the elbow and lift the hose from the socket.

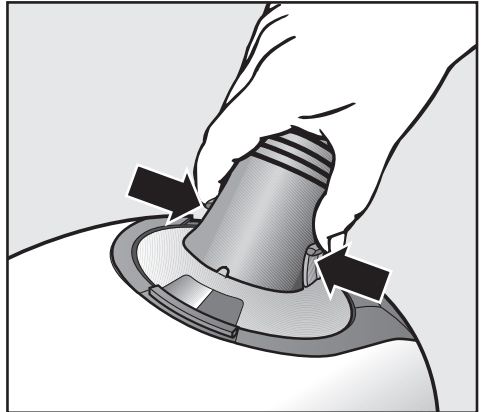

Before using the vacuum cleaner

Connecting the handpiece and the telescopic wand

- Insert the handpiece into the telescopic wand until it clicks. Use the inlet guides to direct insertion.
- To release the handpiece from the telescopic wand press the locking button (see arrow) and pull the handpiece away from the telescopic wand.

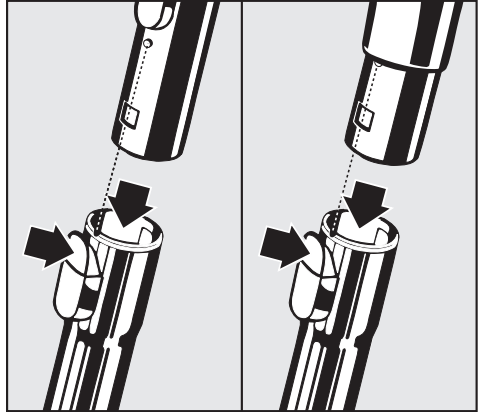

Adjusting the telescopic wand

One section of the telescopic wand is fitted inside the other and can be adjusted to your height for comfortable vacuum cleaning.

- Press the telescopic wand release button (see arrow) to release the tubes and adjust to the required height.

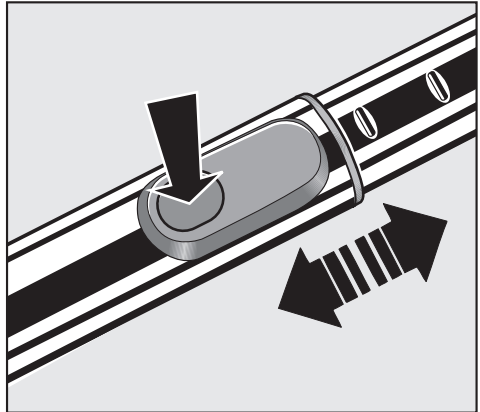

Before using the vacuum cleaner

Connecting the rug/floor tool

(depending on model)

- Insert the telescopic wand into the floor brush and turn in either direction until it locks with a click.
- To release the floor brush from the telescopic wand, press the locking button (see arrow) and pull the wand out of the floor brush.

The floor brush is suitable for cleaning carpets, rugs, and hard surfaces. For flooring susceptible to scratches, use one of the special Miele floor brushes (see "Optional accessories").

Observe the cleaning instructions of the floor manufacturer.

For vacuuming carpets and rugs:

- Press the foot switch marked .

For vacuuming smooth floors:

- Press the foot switch marked .

Floor tool Turbobrush / Powerbrush SEB 217-3 or SEB 236

Models may come with any of these accessories (see "Optional accessories"). Please refer to the separate operating instructions supplied with these brushes for instructions on use and maintenance.

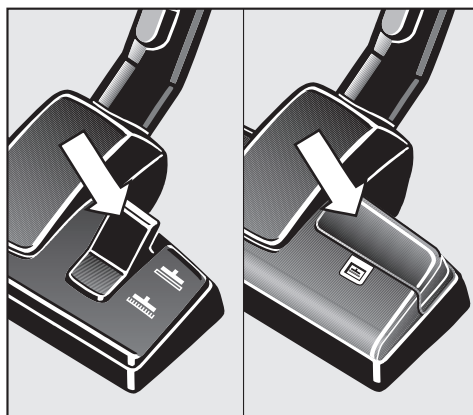
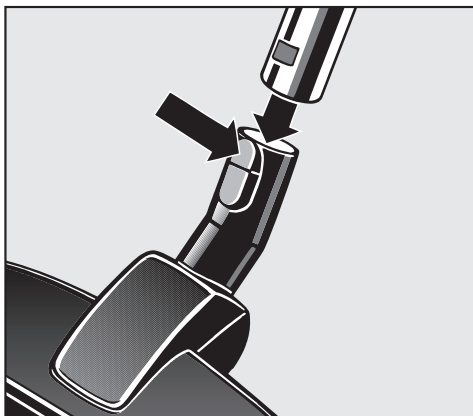

Included accessories

The following accessories are included:

- ① Crevice nozzle
- ② Dust brush with natural bristles
- ③ Upholstery tool



Taking the accessories out

- Press the release button.

The accessory compartment lid opens.

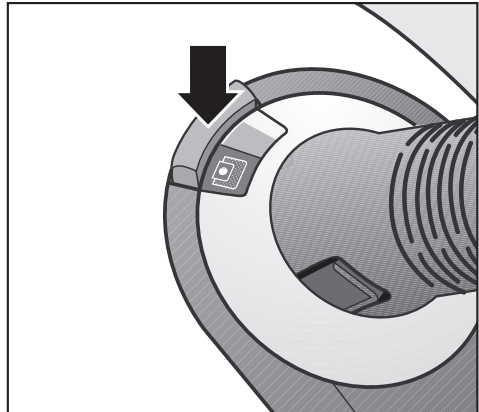

- Take out the accessory needed.
- Close the lid securely.

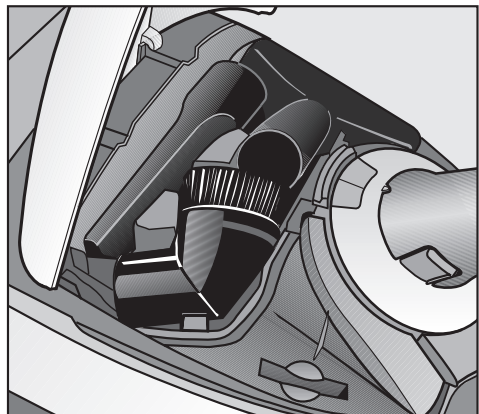

Included accessories

Crevice tool

For cleaning in folds, crevices and corners.

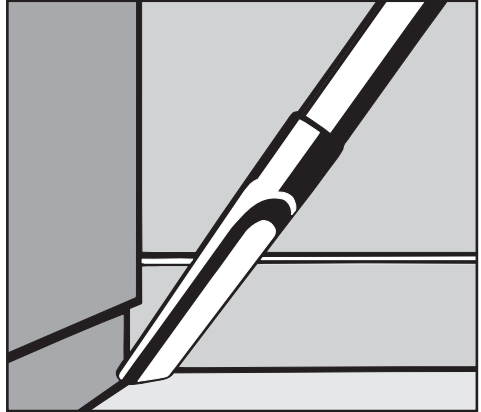

Dust brush with natural bristles

For cleaning moldings, ornate or carved articles, etc.

The head of the dusting brush swivels and can be turned to attain the best cleaning position.



Upholstery tool

For cleaning upholstery, mattresses, cushions, curtains, covers, etc.



Standard floor brush

The standard floor brush can be used for normal cleaning of carpets, rugs, hard surfaces, carpeted stairs, etc.

The comfort handle is shown as an example for all handles and may differ from your individual model.

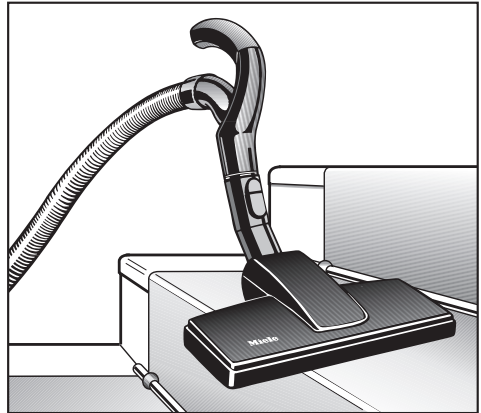

Use

Power cord

 Unwind the cord completely to aid the vacuum in dissipating heat.

Unwinding

- Hold the plug and pull out the power cord.

 To reduce the risk of electric shock, the vacuum has a polarized plug (one blade is wider than the other). This plug will fit in a polarized outlet only one way. If the plug does not fit fully in the outlet, reverse the plug. If it still does not fit, contact a qualified electrician. Do not alter the plug in any way. Danger of overheating and damage.

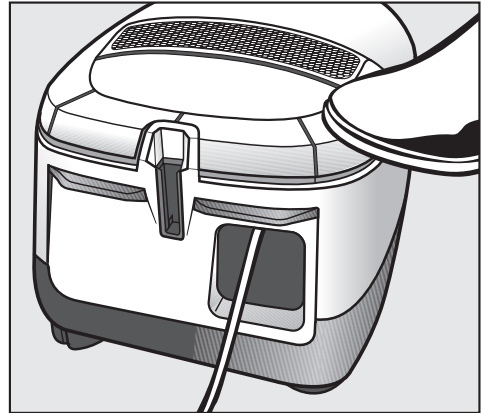
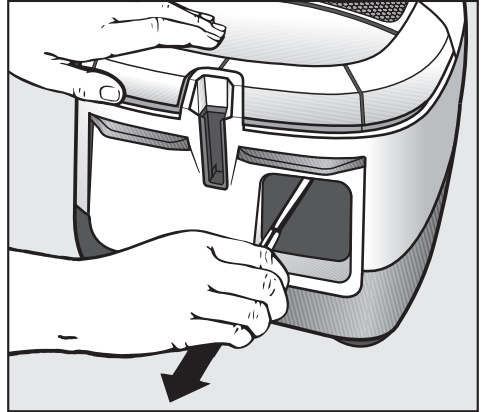

Rewinding

- Unplug the vacuum from the outlet.
- Press the rewind switch - the power cord will rewind automatically. Hold the plug so that it does not whip around when rewinding.

Turning the vacuum On and Off

- Press the On/Off  switch.

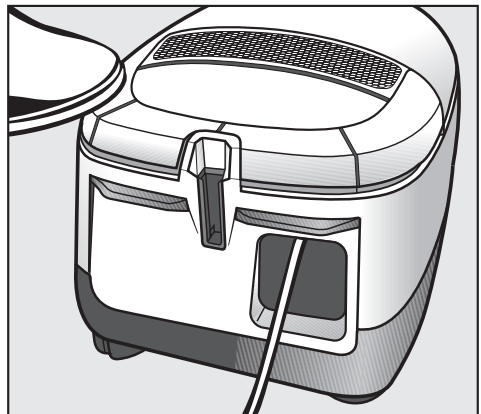

Models with radio frequency controls

The vacuum can be switched to the Standby mode during pauses.

- Press the Standby button at the handpiece.

The LED at the handpiece lights and the vacuum turns off.

To turn the vacuum on:

- Press the Standby button at the hand piece.

The LED goes out and the vacuum cleaner turns on to the last selected power level. The respective symbol on the hand piece lights green.

- Press – to select the lowest power level.
- Press + to select the highest power level.

Only use the Standby mode for short pauses during vacuuming. Do not leave the vacuum in Standby mode, there is a danger of overheating and damage.

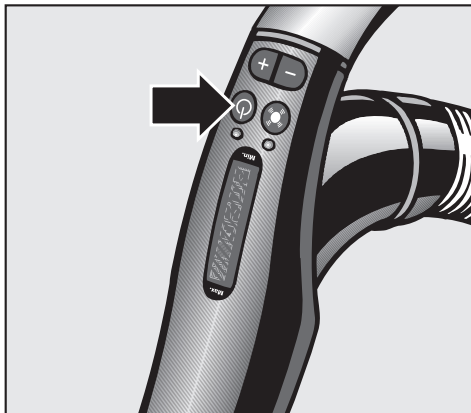

Use

While vacuuming







The vacuum cleaner can also stand on its end for vacuuming stairs, drapes, etc.

 To prevent static electricity your hand must touch the metal inlay on the underside of the vacuum handpiece. Be certain to continuously touch this inlay when vacuuming fine dust, flour or sawdust as these materials are more likely to create a static discharge. To further prevent static discharge while vacuuming, pull the vacuum along by the hose with one hand while continuing to hold the handpiece in the other hand.

Adjusting the suction

The suction power can be adjusted depending on the type of flooring. By reducing the suction power the floor brush can be pushed easier.

The symbols on the controls indicate the type of use the settings are suitable for.

-  curtains, lightweight fabrics
-  upholstery, cushions
-  thick pile carpets, rugs and runners
-  energy saving daily vacuuming with low noise level
-  lightly soiled textured carpets
-  textured hard flooring, and for intensive cleaning of carpets

The controls vary from model to model, and are described on the following pages.

Rotary selector

- Turn the rotary selector to the desired suction power setting.

On some models the symbol of the selected power level lights green.

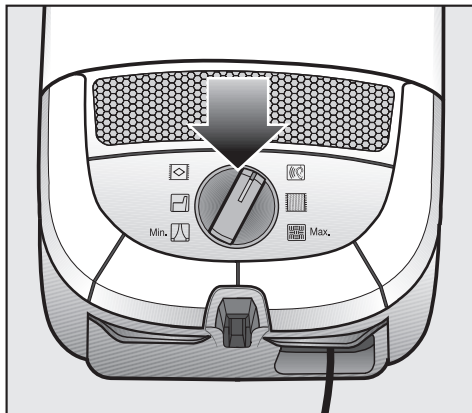

+ / – controls

Press and hold the respective foot switch until the display lights the symbol of the desired power green.

- Press the + control to select a higher setting.
- Press the – control to select a higher setting.

"Auto" level

If the Automatic setting is chosen the vacuum cleaner automatically adjusts the suction power to suit the surface being cleaned.

- Keep pressing the – control until the Automatic setting is activated.
- Press the + control to deactivate the Automatic setting.

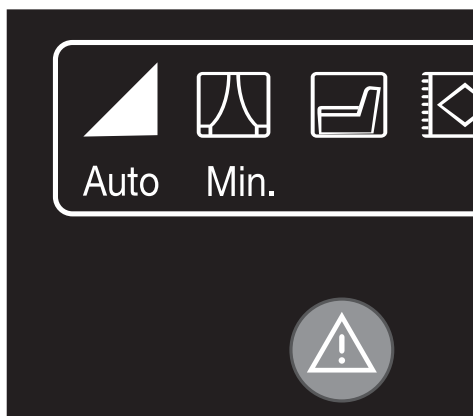
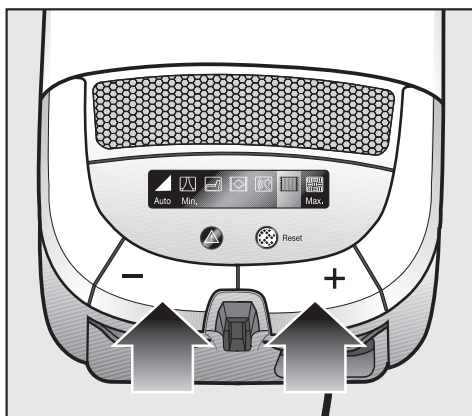

 Do not use the Automatic setting to vacuum lightweight materials or curtains. Excessive suction may cause damage.

Use

Opening the air inlet valve

The air inlet valve is designed to provide a quick, convenient reduction of suction power, e.g. when moving from a carpet to an area rug.

- Open the air inlet valve far enough to reduce the power.

Opening the air inlet valve reduces the power to the tool being used.

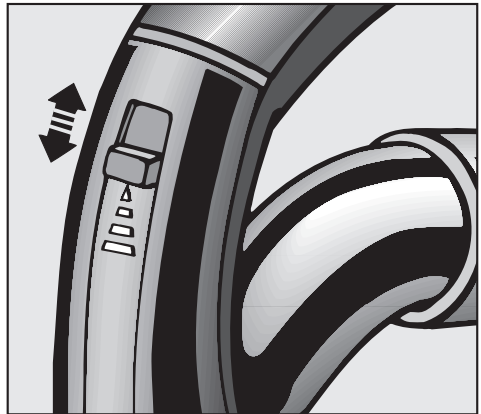
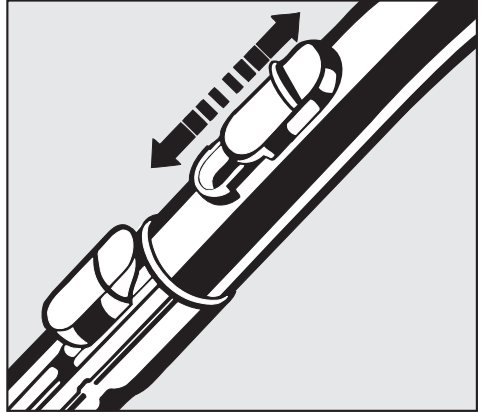

Park-System

(Unable to use with the Powerbrush SEB 236)

A Park-System has been designed to conveniently park the telescopic wand at the vacuum cleaner during pauses.

- A special parking attachment is fitted to all floor brushes. Insert the lower clip on the floor brush into the slot on the end of the vacuum cleaner from above.

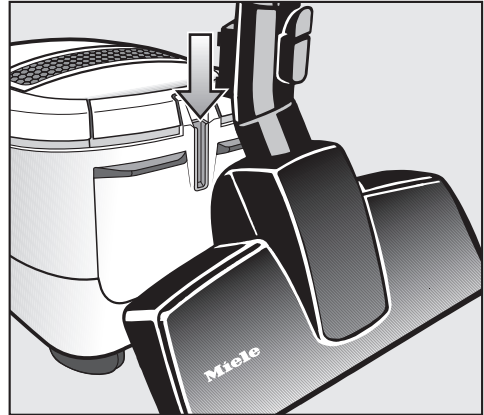

Turning on and off with the Park-System

Some models are equipped with an On/Off switch in the Park-System.

Parking the floor brush while vacuuming automatically turns the vacuum off. Lifting the floor brush out of the Park-System turns the vacuum back on.

If your vacuum cleaner is equipped with +/- suction power selector controls you can activate or deactivate the Park-System's On-Off feature.

- In both cases turn the vacuum off with the foot switch On/Off ①.
- Hold the +/- buttons simultaneously and turn the vacuum on using the On/Off button.

Transport and storage

Transport and storage

- For easier transportation and storage stand the vacuum cleaner vertically.
- Insert both clips of the floor brush into the two point holder on either side of the vacuum (this function cannot be used with the Elelectrobrush SEB 236).

This makes the vacuum easier to carry or store. Push the parts of the telescopic wand into each other for greater stability.

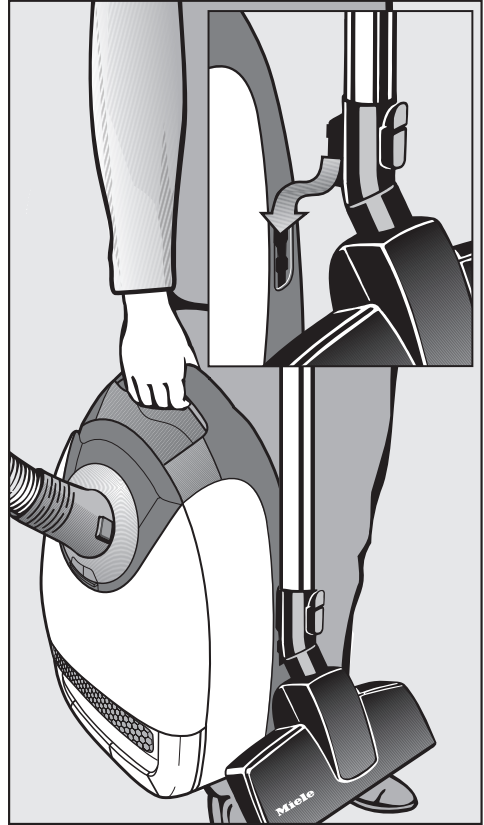

 Turn off and unplug the vacuum before performing any maintenance work.

The Miele filter system consists of the following three components.

- Dustbag
- Exhaust filter
- Dust compartment filter

Each of these filters must be changed periodically to maintain the vacuum cleaner's efficiency.

 Use only Miele dustbags with the Miele quality signet and original Miele filter. This ensures optimum performance of the suction power and also ensures that the bag is used to capacity.

The use of non-Miele dustbags could cause damage to the vacuum cleaner and may void the warranty.

Purchasing new dustbags and filters

Replacement dustbags and filters can be purchased from your local Miele vacuum dealer or Miele.

Which dustbags and filters are the right ones?

Purchase original Miele dustbags with the letter **G/N**.

ORIGINAL
Miele

A "Super Air Clean" exhaust filter and a dust compartment filter are supplied with every box of Miele dustbags. If you wish to purchase exhaust filters or dust compartment filters separately, please quote the model number on the data plate located underneath the appliance.

You can replace the exhaust filter supplied with the vacuum cleaner with one of the other types of filters (see "Exchanging exhaust filters").

Maintenance and care

When to change the dustbag

Change the dustbag when the colored marker in the airflow indicator fills the display.

Miele dust bags are disposable and made to be used only once. Do not attempt to reuse.

Checking the airflow indicator

- Attach the floor tool to the vacuum cleaner. Perform this test with the floor tool only, since other attachments can affect the function of the airflow indicator.
- Turn the vacuum cleaner on and select the highest power setting.
- Lift the floor brush slightly off the floor. If the marker completely fills the indicator window, the dust bag needs to be changed.

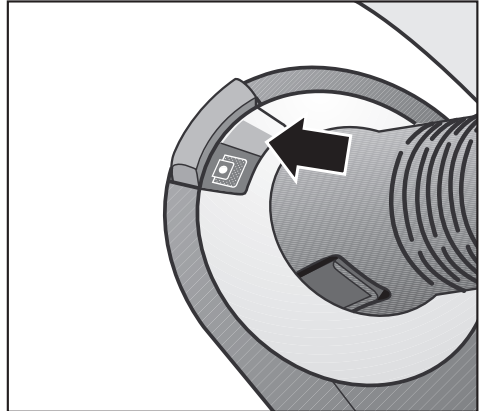

How the airflow indicator works

The airflow indicator is designed to show when the bag is full of common household dust and measures the amount of air flow through the dustbag. Normal household dust is a mixture of dust, hair, carpet fluff, threads, sand, etc.

However, if fine dust, such as drill dust, sand, plaster or flour is vacuumed, the pores of the dustbag may become blocked. The marker will indicate that the bag is "full" even when it is not. The dustbag should be changed as the suction power is greatly reduced.

If the bag is bulging with pet fur, hair, carpet fluff, etc. the indicator may not register "full". This is because the air flow of the dustbag may still be high enough not to activate the marker to show maximum. The dustbag should still be changed.

How to change the dustbag

- Lift the release button for the dust compartment lid and raise the lid until it clicks into place.

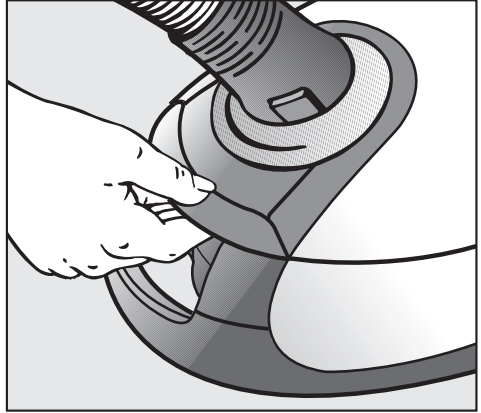

- Grasp the collar by the two finger holes and pull it out from the dustbag holder.

The dustbag has a flap which closes automatically to prevent dust from escaping when the dustbag is removed.

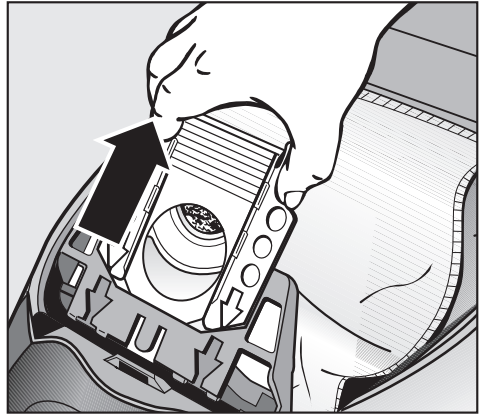

- Insert the new dust bag as far as it will go into the dustbag holder. Do not unfold the dustbag when taking in out of the box. Keeping it folded will prevent it from getting caught when the dust compartment lid is closed.

- Close the dust compartment lid until it clicks into place. Take care not to jam the dust bag in the lid.

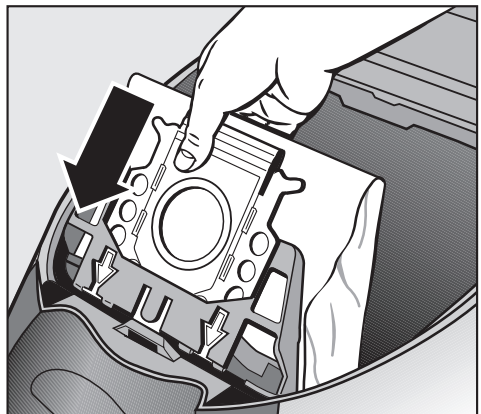

 An empty-operation-barrier blocks the dust compartment lid from closing if no dustbag is inserted or if it is not inserted all the way. Do not force it closed.

Maintenance and care

When to change the exhaust filter

Your model will have either the:

a Super Air Clean

A Super Air Clean filter is supplied with every box of Miele dustbags and should be changed when starting a new box of dustbags.

b Active Air Clean (black)

c Active HEPA (blue)

These filters should be changed approximately once a year. Change the filter sooner if it is obviously soiled or no longer effective. Make a note of the date on the filter. See "Optional Accessories" for descriptions of these two filters.

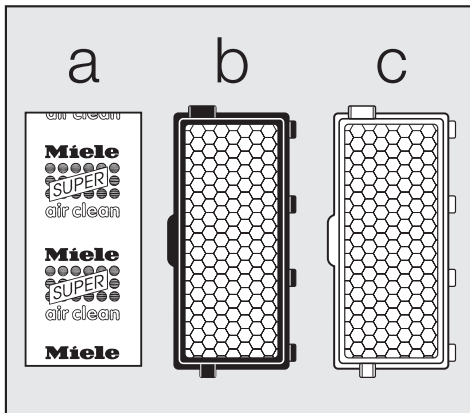

Exhaust filter change indicator

Some models are equipped with an exhaust filter change indicator (Reset button) which is designed to alert the user when to change the "Active Air Clean" or "Active HEPA" filter.

The indicator will light after about 50 hours of operation which is equivalent to a year of average use. The vacuum cleaner can still be used with the exhaust filter indicator lit. However, the suction power will be reduced as will the effectiveness of the filter if it is not replaced.

If a SUPER air clean filter, **a**, is being used, the filter change indicator can be disregarded but should be reset when it does light. The indicator goes out when the reset button is pressed.

You can replace the exhaust filter supplied with the vacuum cleaner with one of the other types of filters (see "Optional accessories").

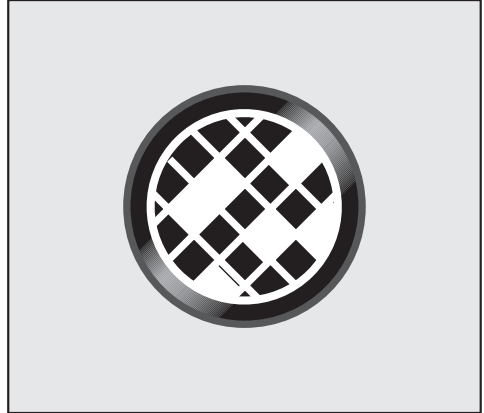

Maintenance and care

Replacing the "Super Air Clean" filter

- Open the dust compartment lid.
- Open the filter frame until it locks into place and remove the used "Super Air Clean" filter by the clean corner (see arrow).

Do not use more than one filter at a time.

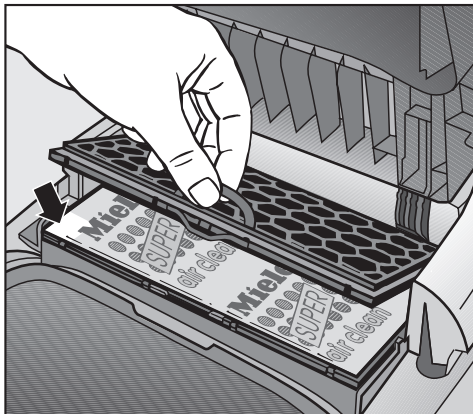

- Insert the new filter (either way up).
- Close the filter frame.

If you wish to replace the SUPER air clean filter with an ActiveAirClean filter or Active HEPA filter see "Maintenance and care - Exchanging exhaust filters".

- Close the dust compartment lid firmly until it clicks into place.

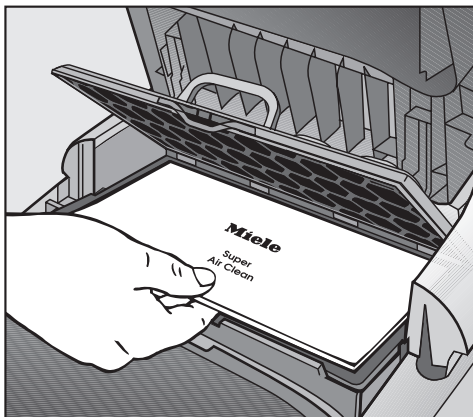

Replacing the "Active Air Clean" filter and the "Active HEPA" filter

- Open the dust compartment lid.

Do not use more than one filter at a time.

- Lift and remove the filter.

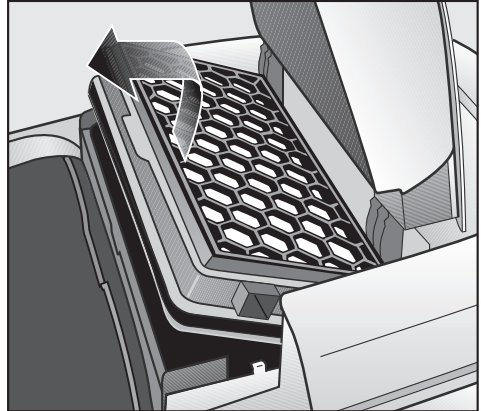

- Insert a new filter and press it downwards.

If you wish to replace the ActiveAirClean filter or the Active Hepa filter with a SUPER air clean filter see "Maintenance and care - Exchanging exhaust filters".

- Close the dust compartment lid firmly until it clicks into place.

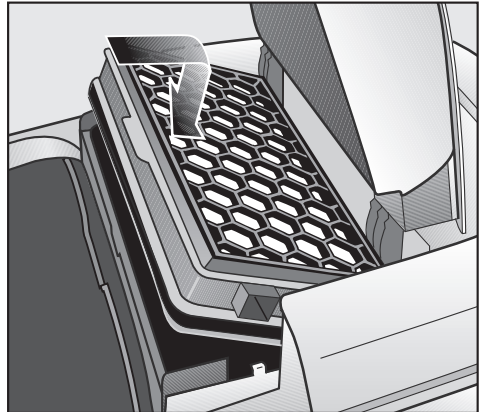

Resetting the filter change indicator

The filter change indicator (Reset button) must be reset each time the filter is replaced. To do this, the vacuum cleaner must be plugged in.

- Press and hold the filter change indicator light until it goes out.

The display is now reset.

The indicator is only reset if pressed while lit. If the indicator is pressed while not lit, it will not be reset.

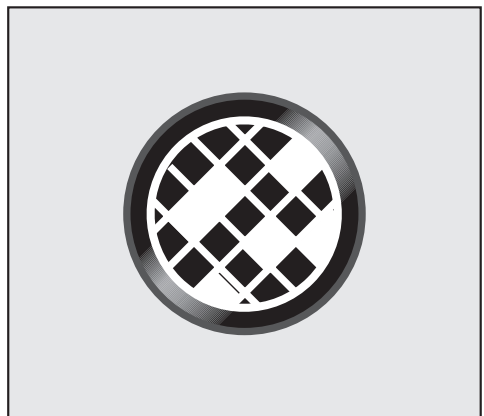

Maintenance and care

Exchanging Exhaust Filters

Your model can have either:

- a** Super Air Clean
- b** Active Air Clean (black)
- c** Active HEPA (blue)

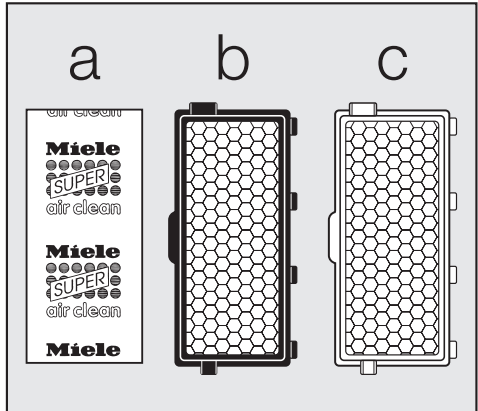

Please note

1. If you wish to replace the **a** Super Air Clean filter with the **b** ACTIVE air clean filter or the **c** Active HEPA filter, you must **remove** the filter frame before inserting the new type of filter.
2. If you use the **a** Super Air Clean filter you have to insert it into a filter frame *.

Do not use more than one filter at a time.

* Filter frame - see "Optional accessories"

Some models are equipped with an exhaust filter reset button. This button is designed for the changing cycle of the Active Air Clean filter and the Active HEPA filter. If a Super Air Clean filter is used, the reset button can be disregarded. The Super Air Clean filter should be changed whenever a new box of Miele dustbags is opened. The indicator goes out when the reset button is pressed.

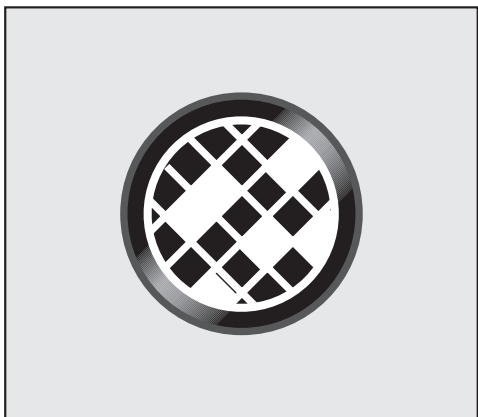

When to change the dust compartment filter

Change the filter each time you open a new box of genuine Miele dustbags. A filter is supplied with every box of Miele dustbags.

How to change the exhaust filter

- Open the dust compartment lid.
- Lift the filter frame and remove the used exhaust filter at the clean side (see arrow).
- Insert the new filter.
- Close the filter frame.

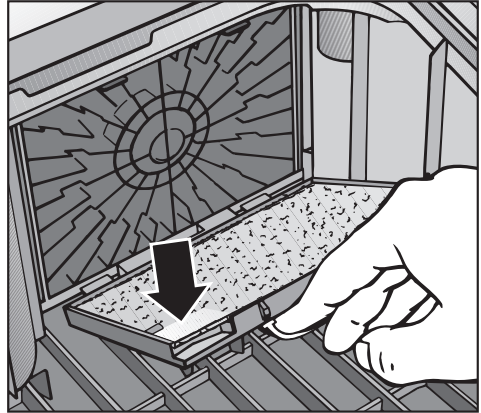

Maintenance and care

When to change the thread catcher

The thread catcher pads on the bottom of the rug and floor tool and the upholstery tool should be replaced as soon as they appear worn.

Changing the thread catcher

- Use a knife or similar object to remove the thread catcher pads from the slots.
- Press the new thread catchers into the slots.

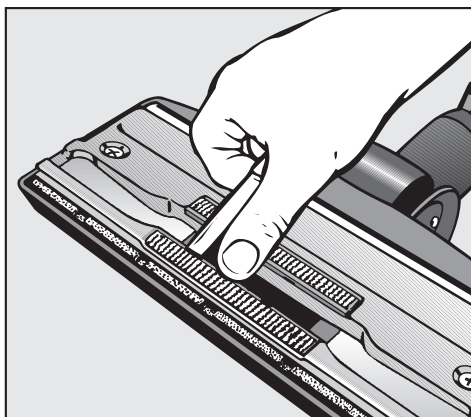

Servicing the floor roller

- Use a coin to release the roller pin and pull it out.
- Push and take out the roller axle.
- Take out the roller.
- Remove all threads, hair, etc. and reassemble the parts.

Spare parts are available from your Miele vacuum dealer or Miele.

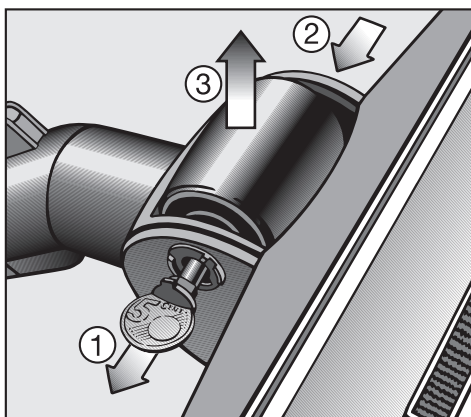

 Turn off the vacuum and unplug it from the outlet before performing any maintenance work.

Vacuum cleaner and accessories

The vacuum cleaner and other plastic accessories can be cleaned with a damp cloth or a cleaner suitable for plastics.

 Do not use abrasive, glass or all purpose cleaners! They will damage the surface.

Dust compartment

The dust compartment can, if necessary, be cleaned using a **dry** cloth, dusting brush or a second vacuum to remove any dust.

Monitor the dustbag change indicator and inspect all filters regularly. Clean or replace them when necessary according to these Operating Instructions.

 Do not submerge the vacuum in water! If moisture gets into the appliance there is the risk of electric shock.

Frequently asked questions

What if the vacuum turns off automatically or a warning light comes on?

The vacuum has overheated. The temperature limiter automatically turns the vacuum off. Some models also have a warning light  which comes on to indicate that the vacuum has overheated.

This can occur if, for instance, large articles block the suction tube or when the filter bag is full or contains particles of fine dust. A heavily soiled exhaust or dust compartment filter can also be the cause of overheating. Turn the vacuum off and pull the plug from the outlet.

- Check for any blockages and allow the vacuum to cool for 30 minutes.



In the event of a fault which you cannot fix yourself please contact the Miele Service Department at the phone number on the back of this booklet.

- Please quote the model type of your appliance.

This can be found on the data plate on the bottom of the vacuum.

Optional accessories

Some models come equipped with one or more of the following accessories.

Powerbrushes

Observe the cleaning instructions of the floor manufacturer.

Models designed for use with a Powerbrush have a release button on the cover cap to the connection socket.

To use a powerbrush the SES 119 or SES 130 electrical hose and SET 210 electric wand must be obtained.

Powerbrush SEB 217-3

The Powerbrush is intended for intensive cleaning and restoration of robust carpeting. It is particularly suitable for cleaning and restoring crushed carpet pile of floor coverings subject to hard wear, especially in high traffic areas.



Powerbrush SEB 236

This Powerbrush is 3" (60 mm) wider and more powerful than the SEB 217-3 model.

It includes:

- a height adjustment
- a light
- a multifunction indicator.



Turbobrush

Observe the cleaning instructions of the floor manufacturer.

The turbobrush is recommended for cleaning short to medium pile carpeting. It is mechanically driven by the suction power of the vacuum. In addition to dust particles it also removes stubbornly adhered threads, hairs and carpet fluff.



Hand Turbobrush

The Hand Turbobrush is intended for vacuuming upholstery, mattresses, car seats, carpeted stairs and other areas inaccessible with the standard Turbobooster.

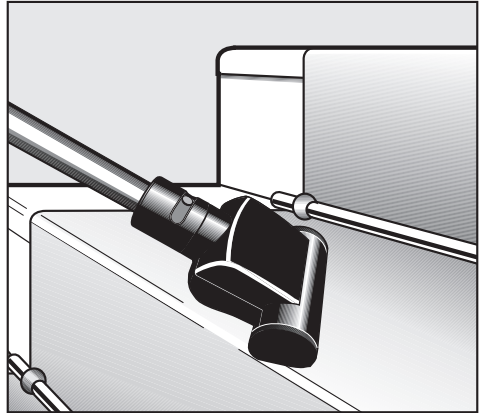

Optional accessories

Hard floor brush SBB 235-3

To vacuum sturdy hard floors, e.g. tiles and stone floors.



Parquet floor brush SBB Parquet-3

Special brush with natural bristles intended for cleaning parquet and laminate floors, especially those susceptible to scratching.

The parquet floor brush can be cleaned with the vacuum cleaner using the crevice nozzle if necessary.



Floor tool SBB 300-3

For cleaning all hard flooring. Especially suitable for vacuuming niches and tight spaces.

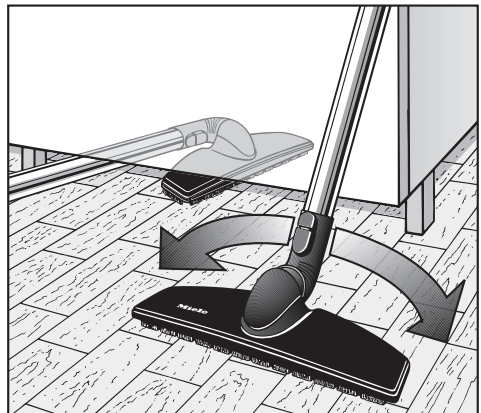

Universal brush

For dusting books, shelves, etc.



Radiator brush

(only usable with the crevice nozzle)

For cleaning radiators, narrow shelves and crevices.

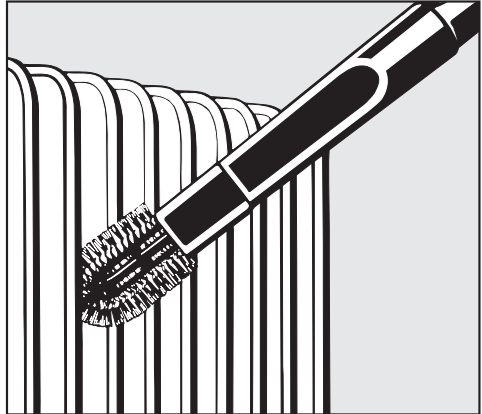

Optional accessories

Mattress tool

For cleaning deep crevices, mattresses and upholstery.



Crevice nozzle 12" (300 mm)

For cleaning in folds, crevices and corners.

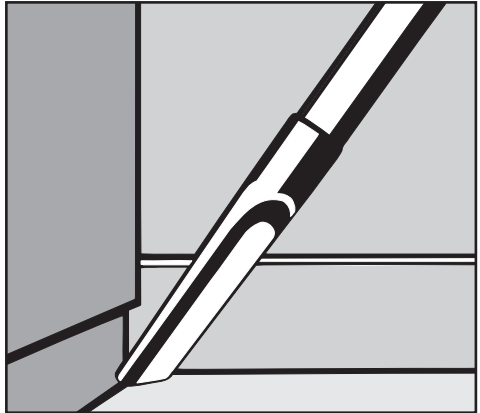

Optional accessories

MicroSet

This set is specially designed for cleaning small objects and difficult to reach areas (such as PC keyboards, stereo equipment, carved furniture, ornaments, models, etc).

Accessory set consists of:

- Micro hose with combi nozzle (crevice nozzle and dust brush)
- Micro dust brush
- Micro crevice nozzle
- Extension

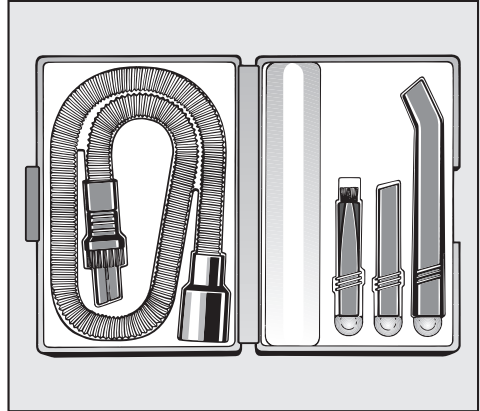

CarClean Set Plus

Specially designed for cleaning car interiors.

Accessory set consists of:

- Hand Turbobrush
- Microhose with combi nozzle
- Crevice tool 12" (300 mm)
- Accessory carrying case
- 10 ft (3 m) long suction hose with holder.

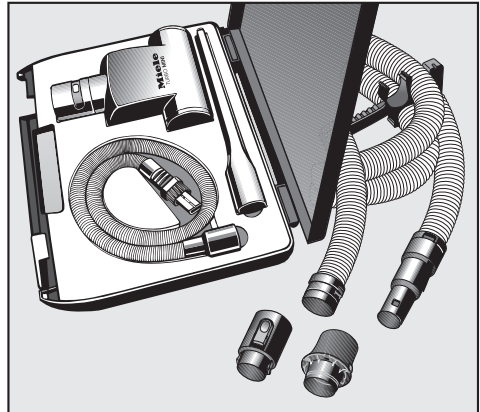

Optional accessories

Active Air Clean filter (black)

A special active charcoal filter which absorbs odors from the dust collected in the dustbag, helping to prevent odors. The "ACTIVE air clean filter" can be used in place of the existing exhaust filter. There is no difference in the fine dust performance of the "Active Air Clean" and the "Super Air Clean" filter.

Active HEPA filter (blue)

The "Active HEPA" filter combines activated charcoal and HEPA filtration in one. The active charcoal layer absorbs odors from the dust collected in the dustbag. Vacuum cleaners equipped with this exhaust filter are particularly suitable for allergy sufferers and those concerned with a high level of hygiene because of its ability to trap respirable particles and allergens.

Filter frame

The filter frame is needed if you would like to exchange a SuperAirClean filter with an Active air Clean or HEPA filter, see "Maintenance and care - Exchanging exhaust filters".

Disposal of the packing materials

The cardboard box and packing materials protect the appliance during shipping. They have been designed to be biodegradable and recyclable.

Ensure that any plastic wrappings, bags, etc. are disposed of safely and kept out of the reach of children. These items pose a danger of suffocation.

Disposing of the dustbag and filters

Genuine Miele dustbags and filters are made of environmentally friendly materials. They can be thrown out with the household trash provided the vacuum cleaner has been used only for normal household dust.

**Please have the model and serial number
of your appliance available before
contacting Technical Service.**



**U.S.A.
Miele, Inc.**

National Headquarters

9 Independence Way
Princeton, NJ 08540
Phone: 800-843-7231
609-419-9898
Fax: 609-419-4298
www.miele.com

**Technical Service & Support
Nationwide**

Phone: 800-999-1360
Fax: 888-586-8056
TechnicalService@mieleusa.com

**Canada
Miele Limited**

Headquarters and Showroom

161 Four Valley Drive
Vaughan, ON L4K 4V8
Phone: 800-643-5381
905-660-9936
Fax: 905-532-2290
www.miele.ca
info@miele.ca (general enquiries)
professional@miele.ca (commercial
enquiries)

MieleCare National Service

Phone: 800-565-6435
905-532-2272
Fax: 905-532-2292
service@miele.ca (technical enquiries)