

Glueless Laminate Installation Instructions— 16" Tile Designs

CAUTION: WOOD DUST

The International Agency for Research on Cancer has classified wood dust as a nasal carcinogen. The sawing, sanding, and/or machining of wood products can produce wood dust that can cause respiratory, eye, and skin irritations.

Wood machining power tools should be equipped with a dust collector to reduce airborne wood dust. Wear an appropriate NIOSH designated dust mask to reduce exposure to airborne wood dust. Avoid contact with eyes and skin by using proper safety glasses and protective clothing. In case of irritation, flush eyes or skin with water for at least 15 minutes. For further technical for installation questions or to request a Product Specification Data Sheet contact the manufacturer at 1-800-441-7429.

Attention California Installers and Consumers

WARNING

Installation of this product and any wood product may create wood dust, which is known to the State of California to cause cancer.

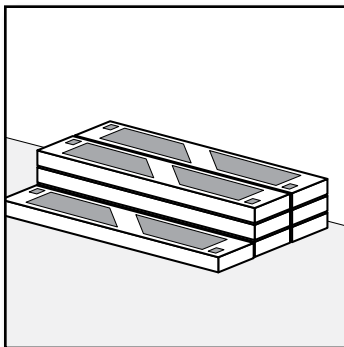

[1] Do not store cartons near heating / cooling ducts or direct sunlight.

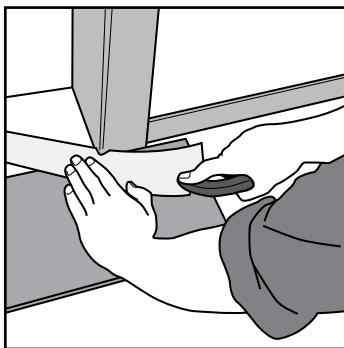

[2] Undercut doorjamb for a professional fit. Doorways less than 6' wide require T-Molding.



Typical Tools Required

Broom, Electric Saw (carbide blade), Eye and Ear Protection, Glue, Hammer, Painter's Tape, Pencil, Pull Bar, Straightedge (6 ft), Tape Measure, Utility Knife, Wall Spacers (1/4"), Wood Chisel.

Preparation

Glueless Laminate can be installed directly over most existing floor coverings except for carpet. Wood flooring glued to concrete must be removed before installation.

Acclimation

- No acclimation period is required when installation site conditions are climate controlled prior to and during installation of Shaw Laminate Flooring Products. This means that Shaw Laminate Flooring products can be installed faster and more efficiently than conventional alternatives.
- During the installation period, temperature should be maintained between 65° F to 85° F and relative humidity should be between 35% to 65%.
- **[1]** Do not store cartons near heating/cooling ducts or direct sunlight.

Subfloor Preparation

- Fill any low spots in the subfloor greater than 1/8" in 6 feet with a Portland cement leveling compound. Check this by using a 6' straight edge. Remove any high spots by sanding or grinding.
- Remove any existing floor molding (if any) except for the wall baseboards. (Unless you plan to replace with Shaw color coordinated Wallbase).
- **[2]** To undercut door frames, lay a loose plank upside down against the frame and on top of the underlayment. This will be your guide for proper height to allow installed planks to float under the door frame. Saw the bottom of the doorjamb case molding back to the wall studs so that 1/4" expansion gap is maintained when laminate is fitted under doorjamb case molding.
- Sweep the subfloor clean.

NOTE: Shaw LocNPlace 16"

Ceramic or Stone Look Products utilize plastic locking clips on the end seam connections. It will be necessary to remove these clips when cutting a plank down to a narrower width.

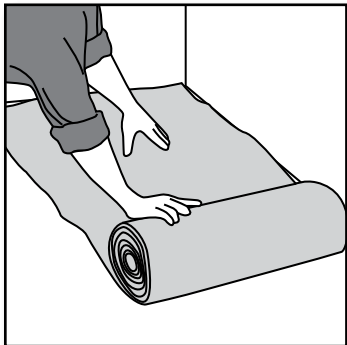

[3] Roll out just enough underlayment for the next few rows of planks you're installing.

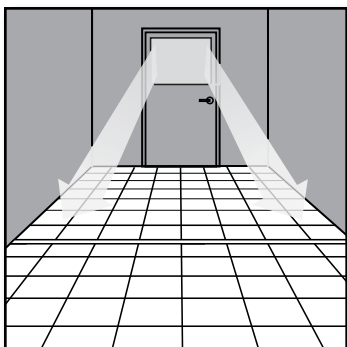

[4] Try to run planks parallel to main light source. T-molding is only required for rooms of more than 1,040 sq. ft.

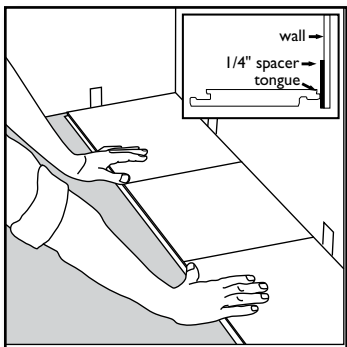

[1] Begin the installation in the left-hand corner. Place the plank a minimum of 1/4" from the left wall. Use the installation spacers throughout all perimeter areas to insure the correct expansion space is maintained.

Subfloor Moisture Testing

- **On Concrete Subfloors**— Always test a concrete subfloor for excessive moisture before installing over concrete, concrete covered with ceramic tile, marble, stone, vinyl tile, or linoleum. To test concrete, use a properly calibrated and reliable concrete moisture meter. The maximum allowable moisture content percentage for concrete is 4%. If the moisture meter readings are above 4%, have a qualified floor covering contractor perform a Calcium Chloride moisture Emissions test. The maximum allowable reading for a Calcium Chloride Test is 5 lbs./1000 sq. ft./24 hours.
- **On Wood-based Subfloors**— Moisture content of the wood subfloor must not exceed 12% when checked using a pin-type wood moisture meter. Whenever readings are higher than 12%, **full evaluations** of the joist systems, crawl spaces or basement areas beneath the wood subflooring are also necessary. **Call Shaw Information Center at 1-800-441-7429 for more assistance.**

Installing Underlayments

When installing products with preattached acoustical underlayment:

- **On Concrete Subfloor**—use minimum 6-mil polyethylene (plastic) sheeting as a vapor barrier. Roll out the plastic, overlapping the seam area 6 to 8 inches, and tape the seams with a clear plastic sealing tape.
- **On a Wood Subfloor**—no additional plastic vapor barrier should be installed.

When installing products without preattached acoustical underlayment:

Please read the installation guidelines included with your chosen underlayment, and strictly follow those instructions when installing your underlayment.

- **[3]** Unroll one width of underlayment along the longest wall. Always work from left to right. Planks should run lengthwise against the longest wall, and if possible, **[4]** parallel to incoming sunlight.
- **[4]** Rooms larger than 26 x 40 feet (1,040 sq. ft.) require T-molding for expansion. Floor spans should not exceed 40' in any direction.

Start of Installation

- When installing the tile look Laminate flooring, it is important to fully measure the room being installed and determine if the walls in the room are truly square to each other in the corners, or if the walls are running away from square out of each corner.
- Lay out several planks in order to determine the best installation pattern for the area **[6]**. Visually, the most appealing layout will have the same width of tile at both sides of the room. Also the width of the first row of tile planks should be approximately the same width as the last row. This may require cutting the first row plank to a smaller width. Measure across the room (inches) and divide by the width of a tile plank to see how many full width planks will be used, and what size width will be needed for the last row. The last row should never be less than 2" in width.
- Tiles should be the same size at all walls. Start the first row using full planks. Stagger the second row by starting with a half plank for the 12" tile look. For the 16" tile look, stagger the second row by starting with one-third or two-thirds of a plank **[6]**.
- The width measurement of the room may require that the full start board may need to be shortened in order to achieve the same size cut tile at each end of the row. For this reason it is advisable that you add approximately 13% waste factor into the required square footage of the installation area. Installations diagonal to the walls of a room will increase this waste factor to approximately 15%.
- Grouted tile planks may have slightly thinner or thicker grout areas on one end of the plank or the other **[7]**. In order to make the grout lines appear uniform throughout the installation, planks with thin grout lines at the end should be mated to planks with thicker grout line ends.
- The center of each grout line should be used when aligning the grout lines in the tile planks with those of the previous row **[7]** This will allow slightly larger or smaller grout widths to appear straight and uniform when viewed across the room.
- Use 1/4" spacers to maintain the proper expansion gap around the entire perimeter of the floor. **Quarter Round** molding will cover this expansion gap. **IMPORTANT:** this 1/4" gap must be maintained around cabinets, pipes, toilet flanges and any other obstacles in floor.
- **INSPECT EACH BOARD CAREFULLY FOR DAMAGE PRIOR TO INSTALLING IT.**
- Do not install a damaged plank. If you have any concern about the product fit or finish, **call Shaw Information Services at 1-800-441-7429 for information.**
- Check groove on plank to make sure it is clean and free of debris.

Follow installation steps [1]–[12].

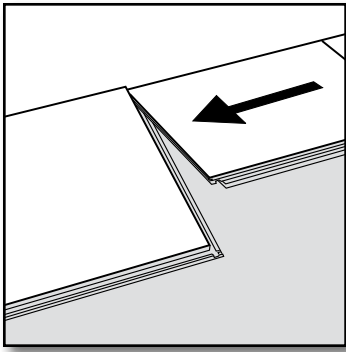

[2] In the first row, place the second plank tight against the short end of the first plank.

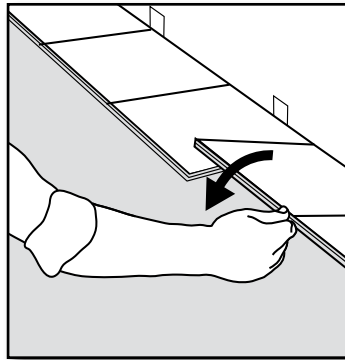

[3] Fold down into the locked position with a single movement. The plastic clips will engage to lock this plank into place.

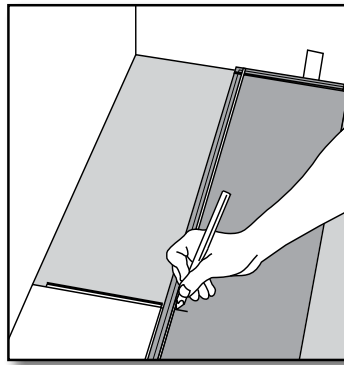

[4] Place the final plank face down with the short side (without the locking strip) towards the wall. The remaining expansion space should be at least a minimum of 1/4" from the wall. Draw a pencil line where the plank is to be cut.

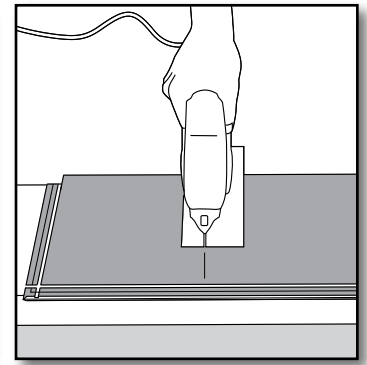

[5] Place the plank face down on the work surface and cut to size with a power saw. If you are using a hand saw, use a fine-toothed blade, and cut the planks face up.

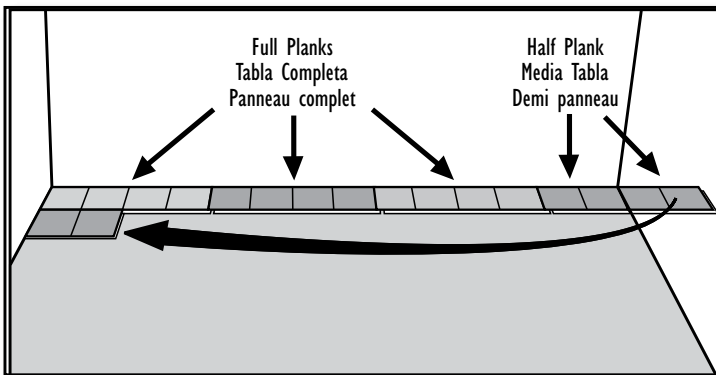

[6] Tiles should be the same size at all walls. Start the first row using full planks. Stagger the second row by starting with a half plank for the 12" tile look. For the 16" tile look, stagger the second row by starting with one-third or two-thirds of a plank.

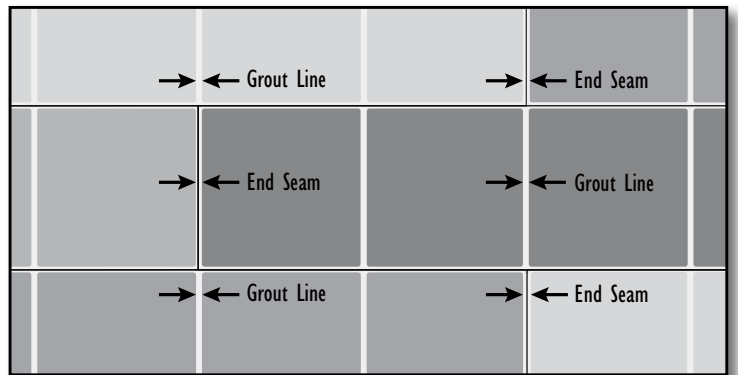

[7] The center of each grout line should be used when aligning the grout lines with those of the previous row. This will allow slightly larger or smaller grout widths to appear straight and uniform when viewed across the room.

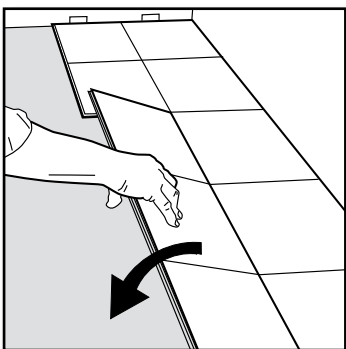

[8] Connect the planks in the following rows by aligning the end seam of each plank directly above the end seam of the preceding plank. Insert the long side seam at a slight angle first, and as the top surfaces meet, rotate the plank down into the locked position.

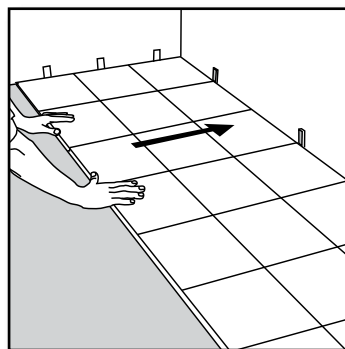

[9] The distance to the walls can be adjusted when three rows are completed. Remember to place the flooring a minimum of 1/4" from all walls or other vertical obstructions such as cabinets, pipes, or columns.

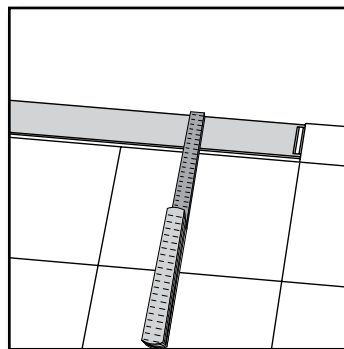

[10] For the last row of planks in the room (and perhaps also the first row if you have elected to cut the starting row to a narrower width), cut the panels lengthwise and glue the short ends. (Remember to carefully remove the plastic locking clips before cutting the planks lengthwise!)

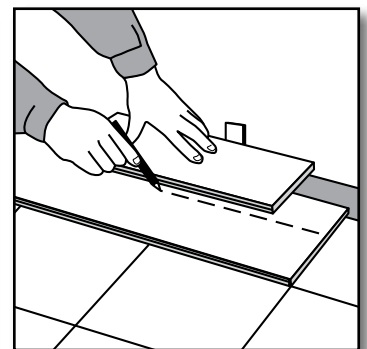

[11] Use a full width scrap plank to mark your cutting line on the last row.

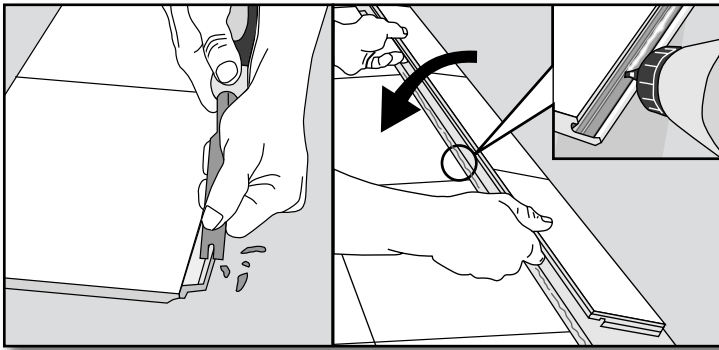

[12] In areas such as a doorjamb or cabinet kick base where planks cannot be angled to lock into place, use a wood chisel to remove the locking ridge from the bottom of the plank groove. Apply a 1/8" bead of tongue and groove adhesive to the bottom groove, and gently tap the plank into place using a pull bar and hammer. Next, apply enough strips of painter's tape across this seam to hold the joint securely in place until the adhesive sets. Using a clean, soft cloth, carefully clean up any excess adhesive on the surface of the planks.

Remainder of Floor

- Repeat the process of using random length start planks (minimum of 16") to ensure a more natural look.
- **Randomly pull planks from 3 cartons at a time** to ensure random appearance. Use cut pieces from the end of each row as starting planks. Always stagger end joints a minimum of 12"; make random so as not to show a repeating pattern.
- **All joints should be a tight fit with no gaps.** Stop and reconnect if a joint is not tight or if all edges are not even with adjacent planks. These planks can be engaged and disengaged several times if needed to help make a correct installation.
- When cutting the last row, place a full row of planks directly on top of the previous row of installed planks (keeping the tongue in the same direction as that of the installed planks). Use the full width of a scrap piece of plank as a guide. Place a pencil next to the edge and trace a line down the planks following the contour of the wall. Cut planks on the pencil line and then connect the last row.

Disassembly

Your floor can be disassembled very easily, enabling replacement during installation and also during use.

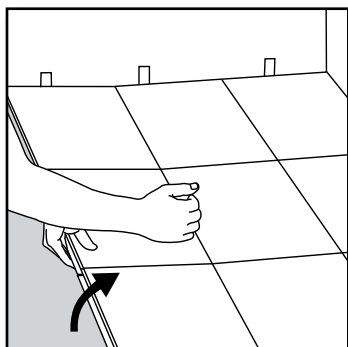

[1] Separate the whole row by carefully lifting up and releasing the whole row. Fold up and release the whole long side of the row, being very careful not to allow the planks to bend downward at the end seams! This could damage the locking mechanism of the plank!

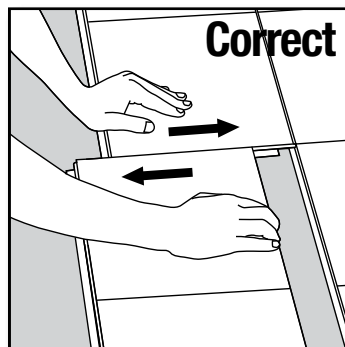

[2] Disassemble the panels by sliding them apart horizontally at the end seams. **(Do not fold connected planks upwards!)**

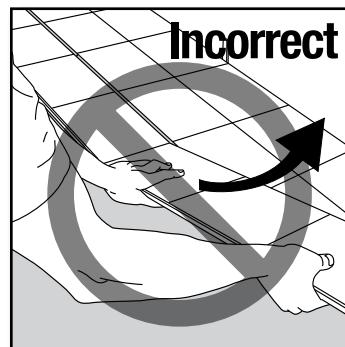

MOLDINGS AND TRANSITION INSTALLATION

Molding and Transitions Installation

- A complete line of trims and transition pieces are offered to finish your floor, including **T-Molding**, **Reducers**, **End Molding/Carpet Transitions**, **Wallbase**, **Quarter Round** and **Stairnosing**.
- The transition pieces, (excluding **Quarter Round** and **Wallbase**) can be easily secured in place with the **Molding Track** which can be screwed, nailed or glued with silicon adhesive directly to the subfloor. The use of **Molding Track** provides a fast, secure transition installation and minimizes the use of screws or nails through the decorative surface of the transition piece.
- **T-Molding** is used when two level flooring surfaces meet, like in a doorway or a narrow archway. In a doorway, center the **T-Molding** under the space that the closed door occupies. Likewise, in an archway, the **T-Molding** should be centered. To install the **T-Molding**, first install the molding track by gluing, screwing or nailing it 1/4" from the edge of each adjoining flooring surface (equals about 1 1/8"). Push the **T-Molding** into the track, working from left to right.
- When laminate flooring meets a flooring surface that is lower, use a **Reducer Strip**. Leave 1/2" space between the finished floor and the front edge of the reducer. Install the **Molding Track** by gluing, screwing or nailing it 1/4" from the edge of the flooring. Push the reducer into the track working from left to right.
- The **End Molding/Carpet Transition** works great when finishing the floor in areas that meet vertical objects and is also ideal for transitioning between your laminate flooring and carpet. To finish the flooring in areas that meet vertical objects like exterior doors, sliding glass doors, tubs or shower basins, raised hearths or low sills, leave a 1" space between the floor and the vertical object. Install the **Molding Track** by gluing, screwing or nailing it 1/4" from the flooring. Push the molding into the track working from left to right.
- When transitioning from laminate flooring to carpet, leave a 1" space between the finished floor and the front edge of the carpet. Install the **Molding Track** by gluing or nailing it 1/4" from the edge of the flooring. Push the molding into the track working from left to right. Finish the carpet by tucking it between the molding and the tack strip.
- **Note:** In heavy traffic areas, use screw-type fasteners or nails to permanently secure the molding into the **Molding Track**.
- The **Stairnosing** is used to finish stair treads and risers, which have been fully adhered to the floor using a **Shaw** approved multipurpose flooring adhesive. Stop the flooring about 1 1/2" from the step's edge. Install the **Molding Track** by gluing, screwing or nailing it 3/4" from the edge of the stair tread. Apply construction grade adhesive to the **Stairnosing** where the molding makes contact with the stair tread. Push the **Stairnose** into the track from left to right. You must use either screw-type fasteners or nails through the face of the **Stairnose** to permanently secure it to the track. Place screws/nails into the **Stairnose** 2" from the end and 6" to 8" apart. (**Note: riser piece should be in place under Stairnosing before screws or nails are used**).
- To finish the perimeter of the room where the expansion space was left for the seasonal expansion and contraction of the flooring, remove spacers and install **Wallbase** and/or **Quarter Round**. Both of these moldings are installed by nailing them directly into the wall. Never allow nails or screws in the **Wallbase** or **Quarter Round** to enter into the laminate flooring or the expansion zone around the flooring perimeter, as it will prevent proper expansion and contraction of the flooring. You must pre-drill nail holes in both types of wall moldings before nailing, to eliminate any splitting. Be sure to nail the **Quarter Round** into the wall or **Wallbase** and not into the flooring as it will prevent expansion and contraction of the flooring. Use **Shaw Color Coordinated Putty** to fill the countersunk nail heads.
- Silicone sealant should be used in expansion zones in bathrooms, near kitchen sinks, dishwashers and refrigerators with icemakers.

For any questions, call the Shaw Information Center at 1-800-441-7429.

CARE GUIDE

Glueless flooring is designed to stand up to the toughest household conditions. However, to keep it looking its best, follow these simple instructions for protection and care.

Routine Maintenance

- Use a damp cloth to blot up spills as soon as they happen. Never allow liquids to stand on your floor.
- Use acetone/nail polish remover on a clean white cloth to clean tough spots such as oil, paint, markers, lipstick, ink, or tar. Wipe the area with a damp cloth to remove any remaining residue.
- Regularly sweep, dust, or vacuum the floor with the hard floor attachment (not the beater bar) to prevent accumulation of dirt and grit that can scratch or dull the floor finish.
- Periodically clean the floor with cleaning products made specifically for laminate floor care such as Shaw's R2x® Hard Surface Cleaner.
- Do not wash or wet mop the floor with soap, water, oil-soap detergent, or any other liquid cleaning material. This could cause swelling, warping, delamination, and joint-line separation, and void the warranty.
- Do not use steel wool, abrasive cleaners, or strong ammoniated or chlorinated type cleaners.
- Do not use any type of buffing or polishing machine.
- For spots such as candle wax or chewing gum, harden the spot with ice and then gently scrape with a plastic scraper such as a credit card. Be careful not to scratch the flooring surface. Wipe clean with a damp cloth.
- A more frequent dust-mopping or vacuuming schedule may be required in very sandy areas such as a beach home.

Environmental Protection:

- Entry mats will help collect the dirt, sand, grit, and other substances such as oil, asphalt, or driveway sealer that might otherwise be tracked onto your floor.
- To prevent slippage of area rugs, use an approved vinyl rug underlayment.
- Use floor protectors and wide, load-bearing leg bases/ rollers to minimize the chance of indentations and scratches from heavy objects. As a rule, the heavier the object, the wider the floor protector.
- To minimize the natural expansion and contraction of the wood, maintain a normal indoor relative humidity level between 35 and 65% throughout the year.

a. Heating season (Dry): A humidifier is recommended to prevent excess shrinkage due to low humidity levels. Wood stove and electric heat tend to create very dry conditions.

b. Non-Heating Season (Wet): An air conditioner, dehumidifier, or periodically turning on your heating will help to maintain humidity levels during summer months.

- Avoid excessive exposure to water during periods of inclement weather.
- Keep your pet's nails trimmed to prevent them from scratching your floor.
- Never try to slide heavy objects across the floor.
- A protective mat should be used under furniture or chairs with castors/wheels.

Minor Repair Instructions:

- In the event that accidental damage occurs, minor scratches or dents can be repaired using a Flooring Touchup or Color-fill Kit. This special touchup kit contains a filler material that is color coordinated to the color of your floor. When Color-filled properly, the repaired area is often invisible. The repaired area should hold up to foot traffic and wear just like the rest of your laminate flooring.

Glueless Laminate Board Replacement Repairs:

- Shaw glueless laminate may be assembled and disassembled several times.
- Carefully disassembled glueless joints will retain their original locking integrity during reassembly. New replacement plank(s) should be acclimated in the replacement area for at least 72 hours. This allows them to equalize to the conditions of the flooring in the room where the replacement(s) will take place.
- To replace the damaged board(s), first remove baseboard, wall base, or Quarter Round as needed. Take the flooring apart one row at a time. Lift each row to detach, then separate the individual boards.
- Be sure to stack the individual planks in the proper order for re-installation. This usually eliminates the need to cut planks for start or end of the row lengths.
- For best visual results, replace the damaged board with a piece from the edge of the original installation.
- Insert the properly acclimated new plank(s) along the outer edge of the original flooring installation during reassembly. This practice minimizes the chance that a newer plank will stand out from the original installation.
- Reinstall the baseboard, wall base, or quarter round, and the replacement repair is complete.