



MEMORY FOAM BODY PILLOW



FULL BODY
SUPPORT (20" X 54")



100% DICED GREEN
TEA MEMORY FOAM



SOFT & COOLING
BAMBOO PILLOWCASE



BODY PILLOW USER MANUAL

READ AND SAVE THESE INSTRUCTIONS

Inspect Unit Before Use. Contact support@upperechelonproducts.com immediately for any damaged or defective units.

TABLE OF CONTENTS

1 COMPONENTS

2 HOW TO USE

3 CLEANING INSTRUCTIONS

4 SPECIFICATIONS

1. COMPONENTS

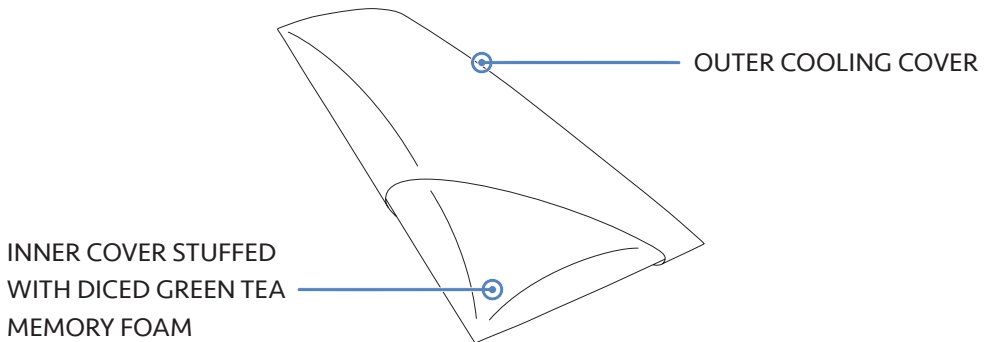

BEFORE FIRST USE

The pillow arrives vacuum sealed. Unwrap and unroll the pillow from its packaging and let it sit for 12-24 hours until it has expanded.

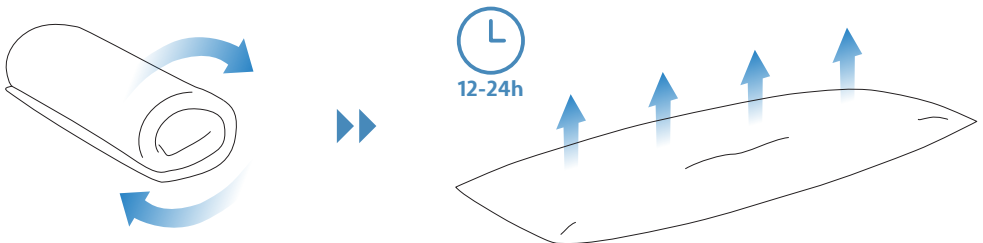

2. HOW TO USE

- 1 a.** Before first use, fluff the pillow by putting it in the dryer with a dryer sheet for 2-3 minutes. Make sure to only use low heat. This will help soften and redistribute the memory foam.

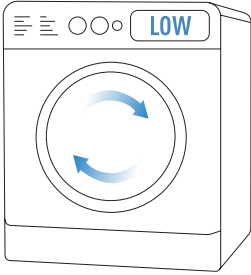

- b.** Don't have a dryer? No problem! Fluff the pillow manually by GENTLY punching, prodding and massaging it for several minutes.

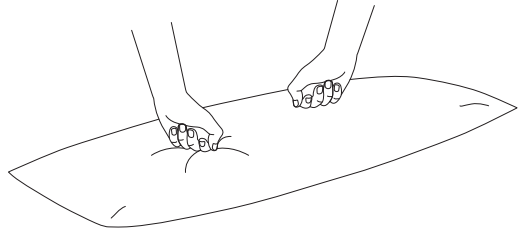

NOTE

You do not need to put the cooling pillowcase in the dryer before its first use.

- 2** Place the cooling pillowcase on the pillow.

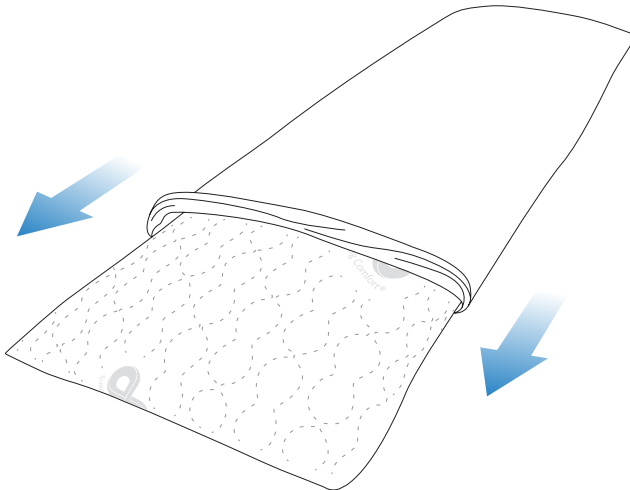

COMMON WAYS TO USE THE EVERLASTING COMFORT BODY PILLOW

UPPER BODY SUPPORT

Provides support for the head, neck, shoulder, and spine while sleeping.

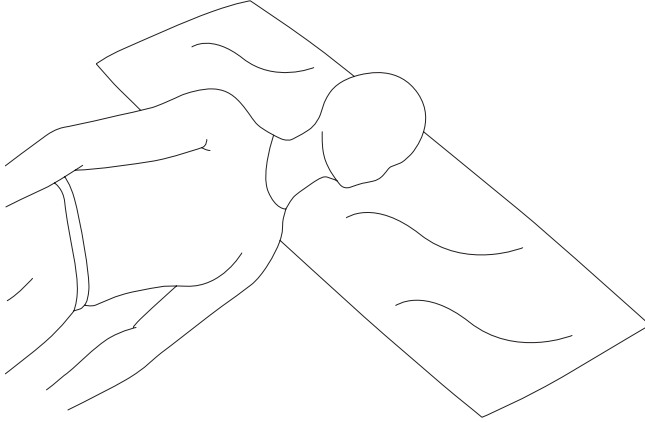

SITTING & SLEEPING BACK SUPPORT

In the sitting position, the pillow reduces tension on the back and provides elevated support for reading, watching TV, or nursing.



In the sleeping position, the pillow reduces pressure on the back and minimizes tossing and turning.

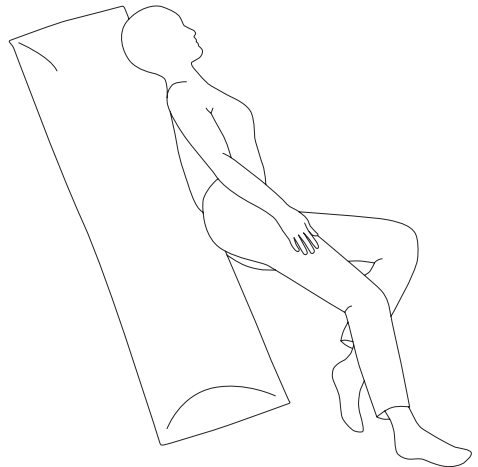

LEG ELEVATION & KNEE SUPPORT

Elevated support for the legs and knees helps support blood circulation. Using between the knees while sleeping improves spinal alignment.

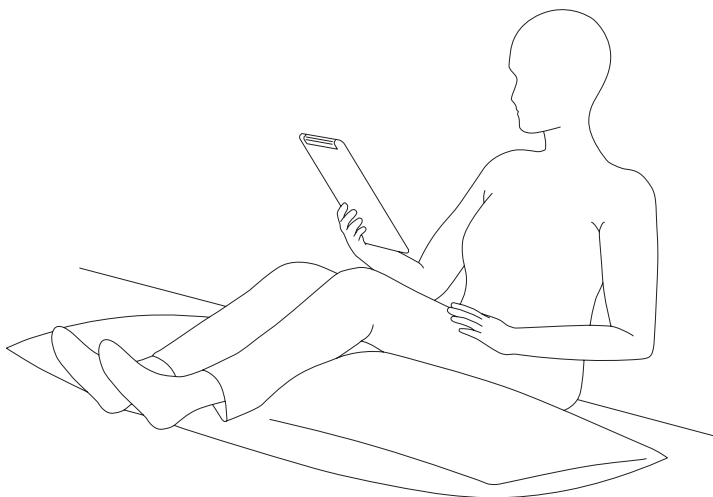

FULL BODY SUPPORT

Supports head, neck, shoulders, torso, hips, legs, and feet at the same time.

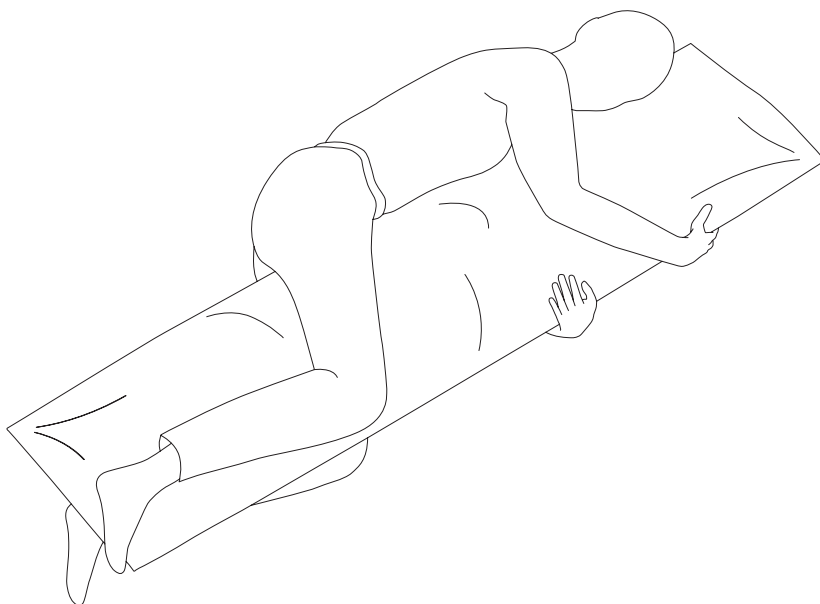

PREGNANCY SUPPORT

Provides support and reduces pressure on the back during pregnancy.

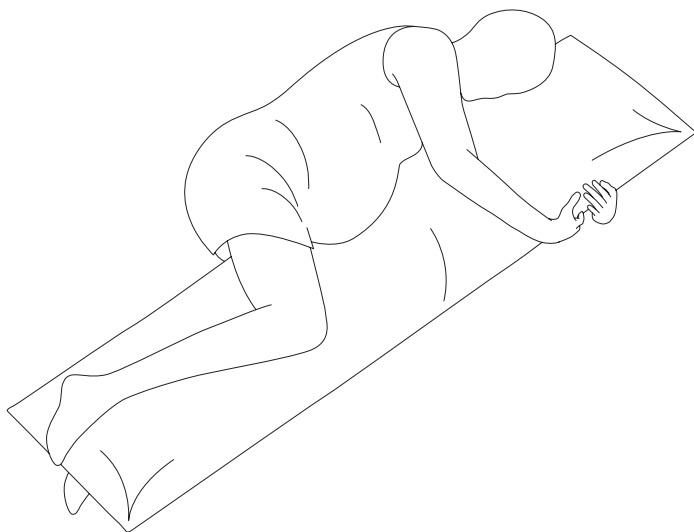

NOTE

Diced memory foam can be removed and added as necessary, so you get to enjoy the pillow exactly as you like it.

3. CLEANING INSTRUCTIONS

Soft bamboo fabric cover is removable.

1 Unzip the zipper on the side of the pillow.

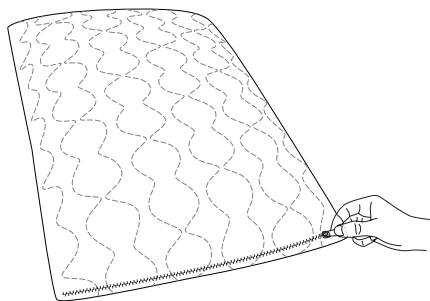

2 Remove the outer cover from the pillow.

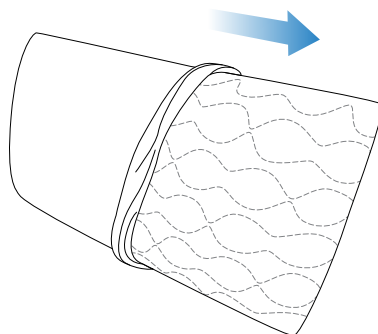

- 3** Unzip the inner cover and remove the memory foam stuffing.

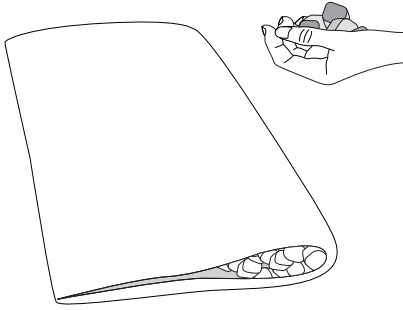

NOTE

We recommend you store the diced memory foam stuffing in a bag or bin while washing the covers.

- 4** Both the inner cover and outer cover can be machine washed in cold water and are dryer safe on low heat or air fluff.

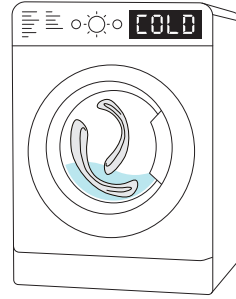

IMPORTANT

DO NOT PUT MEMORY FOAM IN WASHER!

4. SPECIFICATIONS

Dimensions (Package)

43cm * 21cm * 21cm

HAVE AN ISSUE WITH YOUR BODY PILLOW?

Enjoy hassle-free replacements: if your Body Pillow is defective or damaged, we will ship you a new one ABSOLUTELY FREE.

For fast and knowledgeable service, get in touch with one of our customer service experts right now!



everlastingcomfort.net



+1 787-270-7661



support@upperechelonproducts.com

WRITE A MESSAGE
TO SUPPORT



To check out more of the products we offer visit:

everlastingcomfort.net

