

EFFECTIVE:
15-FEB-17

DIMENSION PRINT
WORLD MOTOR CORRODUTY
FRAME: 324T, 326T
BASIC TYPE: TC

PRINT:
08-1024

SUPERSEDES:
NEW

SHEET:
1 OF 1

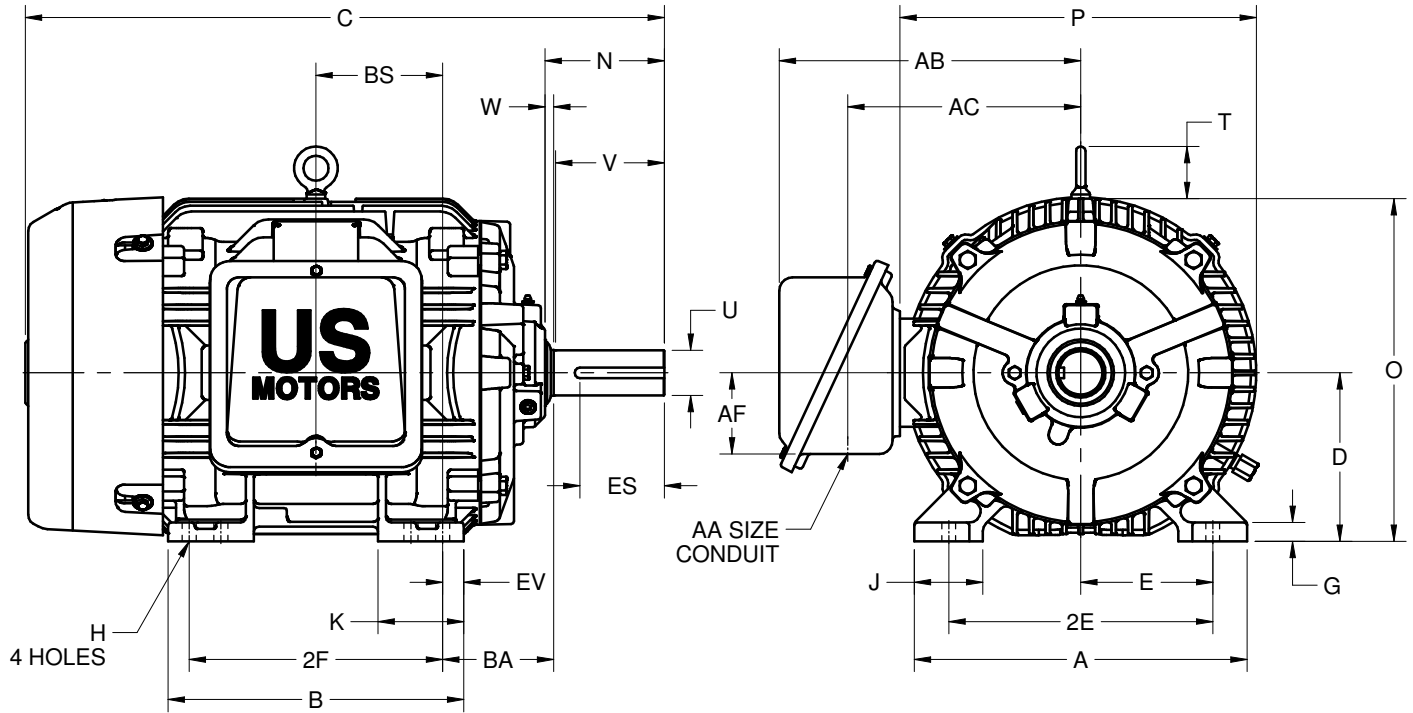

ALL DIMENSIONS ARE IN INCHES AND MILLIMETERS

UNITS	A	B	C	D -.06	E	2E ±.03	G	H +.05	J	K	N	O	P ²
IN	15.75	14.00	30.28	8.00	6.25	12.50	.91	.66	3.25	4.06	5.66	16.25	17.09
MM	400	356	769	203	159	318	23	17	83	103	144	413	434

UNITS	T	U -.001	V MIN	W	AA	AB	AC	AF	BA	BS	EV	ES MIN	SQ KEY
IN	2.47	2.125	5.00	.41	2 NPT	14.28	11.03	3.84	5.25	6.00	1.00	3.91	.500
MM	63	53.98	127	10		363	280	98	133	152	25	99	12.70

FRAME	UNITS	2F ±.03
324T	IN	10.50
	MM	267
326T	IN	12.00
	MM	305

1. DIMENSIONS MAY VARY .25" DUE TO CASTING AND/OR FABRICATION VARIATIONS
2. LARGEST MOTOR WIDTH
3. STANDARD ASSEMBLY POSITION F-1 IS SHOWN. F-2 IS PROVIDED WHEN SPECIFIED. CONDUIT OPENING MAY BE LOCATED IN STEPS OF 90° REGARDLESS OF THE LOCATION
4. TOLERANCES ARE SHOWN IN INCHES ONLY

08-1024/-

Nidec Motor Corporation
St. Louis, Missouri

INFORMATION DISCLOSED ON THIS DOCUMENT IS CONSIDERED PROPRIETARY AND SHALL NOT BE REPRODUCED OR DISCLOSED WITHOUT WRITTEN CONSENT OF NIDEC MOTOR CORPORATION



ISSUED BY
R. TIMMERMANN
APPROVED BY
M. CULLEN

IHP_DP_NMCA (MAR-2011) SOLIDEDGE