

36LY5382

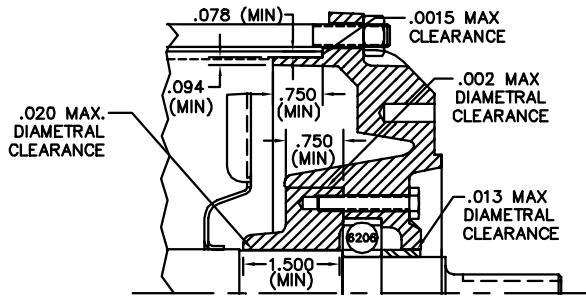
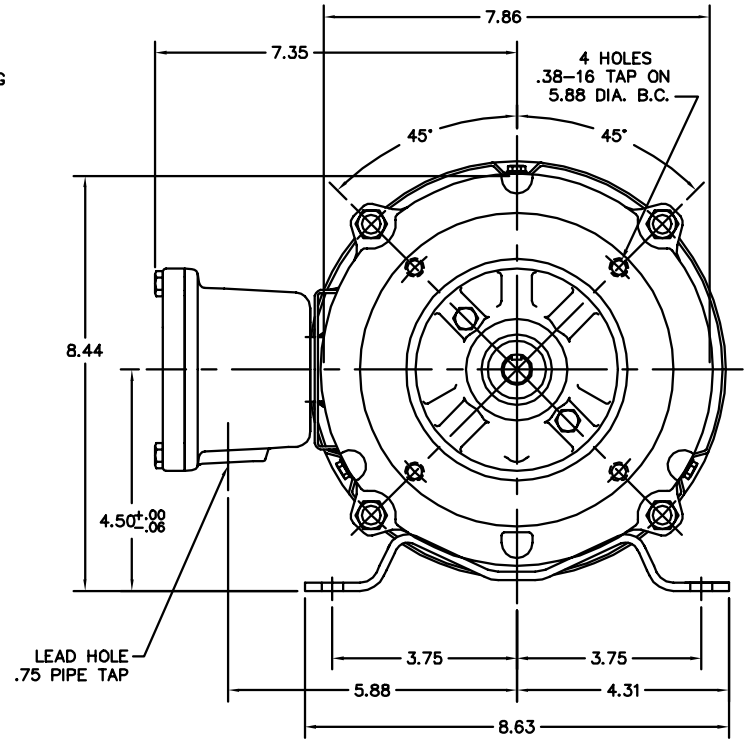
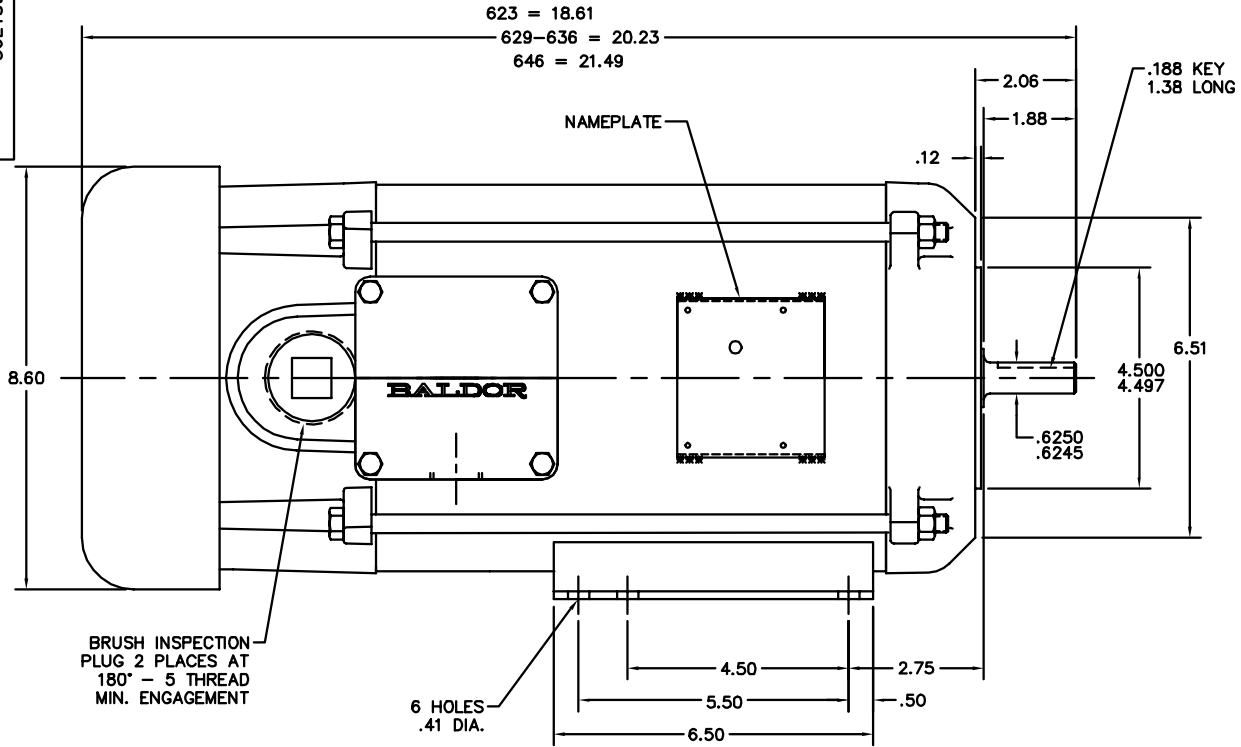

CUSTOMER IS RESPONSIBLE FOR DETERMINING THAT BALDOR'S PRODUCT WILL PERFORM SUITABLY IN THE INTENDED APPLICATION.

REV. DESC: ADD CLII GP F & G TO DRAWING		
REV. LTR: F	VERSION: 01	TDR: 00000050525
FILE: \AAA\00023\906	REVISED: 02:09:13 07/14/2009	BY: ENROSTO
MTL: -		

BALDOR • DODGE • RELIANCE

HOR X36DC 182-4CZ TEFC FACE MTD UL CLI-GP D,CLII GP F&G

SH 1 of 1

36LY5382