

LIVETOOLS[®]
Machine Tool People.
www.livetools.com.au

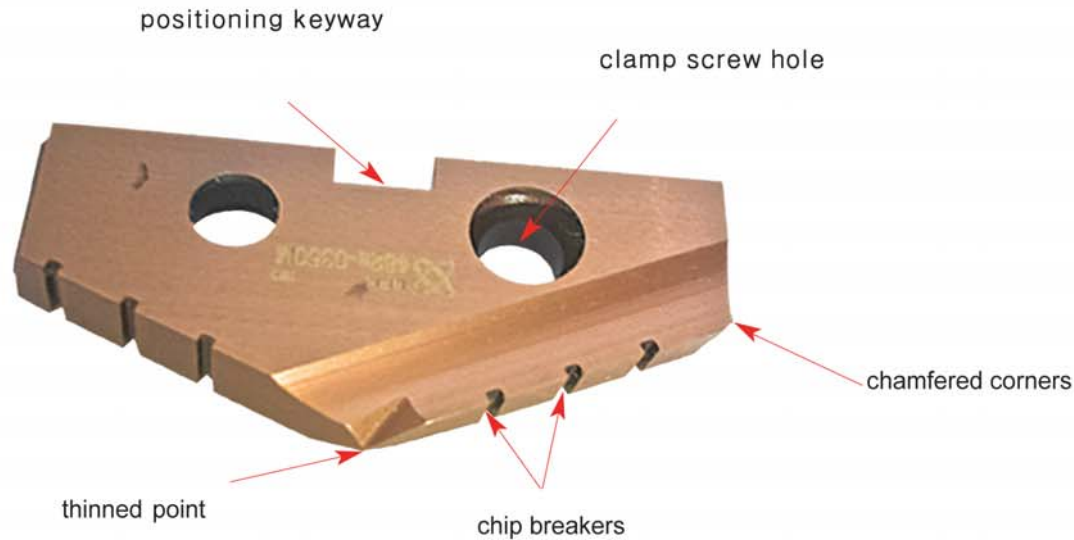

Spade Drill Catalogue

(SPADE DRILL INSERT)



SPADE DRILL CHARACTER

1. **Range of insert** : diameter 9.5mm~114.0mm
2. **Range of holder** : Stocked item-maximum length $13 \times D$
Manufactured upon request only-maximum length $30 \times D$
3. Each holder is available to choose diameter of insert among customer's needs.
Each series insert is possible to fit in a holder.
For example, 9.5mm~114.0mm inserts can be fitted in 9 holders.
4. It's useful to substitute B7 drill for integral HSS drill
Advantage-extended tool life : material of insert is power.
It's 3~5 times longer tool life than integral HSS.
5. **Excellent chip evacuation** : chip is divided to 2~3 small chips by chip divider.
Reduced resistance by chip evacuation : It's possible to do big diameter drilling in any machine.
6. **Internal coolant oil hole system** : It's useful to do deep drilling.
7. **Advanced performance** : B7 drill support customer better quality, tolerance than integral HSS drill.
8. **Modular system** : It's available to extend drilling length.

(B7 INSERT ITEM NUMBER)

48 3 A - 460

GRADE

04-M4 (HSS cobalt 0%)
15-T15(HSS cobalt 5%)
48-M48(HSS cobalt 8%)
C5 (carbide P25)

SERIES

Y.- ϕ 9.5~ ϕ 11.0
Z.- ϕ 11.5~ ϕ 12.5
0.- ϕ 13.0~ ϕ 17.5
1.- ϕ 18.0~ ϕ 24.0
2.- ϕ 25.0~ ϕ 35.0
3.- ϕ 36.0~ ϕ 47.0
4.- ϕ 48.0~ ϕ 65.0
5.- ϕ 63.5~ ϕ 76.0
6.- ϕ 78.0~ ϕ 88.0
7.- ϕ 90.0~ ϕ 100.0
8.- ϕ 102.0~ ϕ 114.0

COATING GRADE

A-TiALN
C-TiCN
T-TiN
i-ALTiN (ACCORDING TO CUSTOMER ORDER)
D-NANO DIAMOND (ACCORDING TO CUSTOMER ORDER)

INSERT DIAMETER

LIVETOOLS[®]
Machine Tool People.
www.livetools.com.au





HSS

SPADE DRILL INSERTS

AVAILABLE IN FRACTION SIZES

Stock Item (Marked Yellow)

SPADE DRILL INSERTS





		TiN 			TiCN 			TiAlN 			ALTiN 		
METRIC (mm)		HSS(M4)	SUPER HSS (T-15)	PREMIUM HSS (M48)	HSS(M4)	SUPER HSS (T-15)	PREMIUM HSS (M48)	HSS(M4)	SUPER HSS (T-15)	PREMIUM HSS (M48)	HSS(M4)	SUPER HSS (T-15)	PREMIUM HSS (M48)
Y	9.50		15YT-095	48YT-095		15YC-095	48YC-095		15YA-095	48YA-095		15Yi-095	48Yi-095
	10.00		15YT-100	48YT-100		15YC-100	48YC-100		15YA-100	48YA-100		15Yi-100	48Yi-100
	10.50		15YT-105	48YT-105		15YC-105	48YC-105		15YA-105	48YA-105		15Yi-105	48Yi-105
	11.00		15YT-110	48YT-110		15YC-110	48YC-110		15YA-110	48YA-110		15Yi-110	48Yi-110
Z	11.50		15ZT-115	48ZT-115		15ZC-115	48ZC-115		15ZA-115	48ZA-115		15Zi-115	48Zi-115
	12.00		15ZT-120	48ZT-120		15ZC-120	48ZC-120		15ZA-120	48ZA-120		15Zi-120	48Zi-120
	12.50		15ZT-125	48ZT-125		15ZC-125	48ZC-125		15ZA-125	48ZA-125		15Zi-125	48Zi-125
O	13.00		150T-130	480T-130		150C-130	480C-130		150A-130	480A-130		150i-130	480i-130
	13.50		150T-135	480T-135		150C-135	480C-135		150A-135	480A-135		150i-135	480i-135
	14.00		150T-140	480T-140		150C-140	480C-140		150A-140	480A-140		150i-140	480i-140
	14.50		150T-145	480T-145		150C-145	480C-145		150A-145	480A-145		150i-145	480i-145
	15.00		150T-150	480T-150		150C-150	480C-150		150A-150	480A-150		150i-150	480i-150
	15.50		150T-155	480T-155		150C-155	480C-155		150A-155	480A-155		150i-155	480i-155
	16.00		150T-160	480T-160		150C-160	480C-160		150A-160	480A-160		150i-160	480i-160
	16.50		150T-165	480T-165		150C-165	480C-165		150A-165	480A-165		150i-165	480i-165
	17.00		150T-170	480T-170		150C-170	480C-170		150A-170	480A-170		150i-170	480i-170
	17.50		150T-175	480T-175		150C-175	480C-175		150A-175	480A-175		150i-175	480i-175
1	18.00	041T-180	151T-180	481T-180	041C-180	151C-180	481C-180	041A-180	151A-180	481A-180	041i-180	151i-180	481i-180
	18.50	041T-185	151T-185	481T-185	041C-185	151C-185	481C-185	041A-185	151A-185	481A-185	041i-185	151i-185	481i-185
	19.00	041T-190	151T-190	481T-190	041C-190	151C-190	481C-190	041A-190	151A-190	481A-190	041i-190	151i-190	481i-190
	19.50	041T-195	151T-195	481T-195	041C-195	151C-195	481C-195	041A-195	151A-195	481A-195	041i-195	151i-195	481i-195
	20.00	041T-200	151T-200	481T-200	041C-200	151C-200	481C-200	041A-200	151A-200	481A-200	041i-200	151i-200	481i-200
	20.50	041T-205	151T-205	481T-205	041C-205	151C-205	481C-205	041A-205	151A-205	481A-205	041i-205	151i-205	481i-205
	21.00	041T-210	151T-210	481T-210	041C-210	151C-210	481C-210	041A-210	151A-210	481A-210	041i-210	151i-210	481i-210
	22.00	041T-220	151T-220	481T-220	041C-220	151C-220	481C-220	041A-220	151A-220	481A-220	041i-220	151i-220	481i-220
	23.00	041T-230	151T-230	481T-230	041C-230	151C-230	481C-230	041A-230	151A-230	481A-230	041i-230	151i-230	481i-230
	24.00	041T-240	151T-240	481T-240	041C-240	151C-240	481C-240	041A-240	151A-240	481A-240	041i-240	151i-240	481i-240
2	25.00	042T-250	152T-250	482T-250	042C-250	152C-250	482C-250	042A-250	152A-250	482A-250	042i-250	152i-250	482i-250
	26.00	042T-260	152T-260	482T-260	042C-260	152C-260	482C-260	042A-260	152A-260	482A-260	042i-260	152i-260	482i-260
	27.00	042T-270	152T-270	482T-270	042C-270	152C-270	482C-270	042A-270	152A-270	482A-270	042i-270	152i-270	482i-270
	28.00	042T-280	152T-280	482T-280	042C-280	152C-280	482C-280	042A-280	152A-280	482A-280	042i-280	152i-280	482i-280
	29.00	042T-290	152T-290	482T-290	042C-290	152C-290	482C-290	042A-290	152A-290	482A-290	042i-290	152i-290	482i-290
	30.00	042T-300	152T-300	482T-300	042C-300	152C-300	482C-300	042A-300	152A-300	482A-300	042i-300	152i-300	482i-300
	31.00	042T-310	152T-310	482T-310	042C-310	152C-310	482C-310	042A-310	152A-310	482A-310	042i-310	152i-310	482i-310
	32.00	042T-320	152T-320	482T-320	042C-320	152C-320	482C-320	042A-320	152A-320	482A-320	042i-320	152i-320	482i-320
	33.00	042T-330	152T-330	482T-330	042C-330	152C-330	482C-330	042A-330	152A-330	482A-330	042i-330	152i-330	482i-330
	34.00	042T-340	152T-340	482T-340	042C-340	152C-340	482C-340	042A-340	152A-340	482A-340	042i-340	152i-340	482i-340
	35.00	042T-350	152T-350	482T-350	042C-350	152C-350	482C-350	042A-350	152A-350	482A-350	042i-350	152i-350	482i-350
3	36.00	043T-360	153T-360	483T-360	043C-360	153C-360	483C-360	043A-360	153A-360	483A-360	043i-360	153i-360	483i-360
	37.00	043T-370	153T-370	483T-370	043C-370	153C-370	483C-370	043A-370	153A-370	483A-370	043i-370	153i-370	483i-370
	38.00	043T-380	153T-380	483T-380	043C-380	153C-380	483C-380	043A-380	153A-380	483A-380	043i-380	153i-380	483i-380
	39.00	043T-390	153T-390	483T-390	043C-390	153C-390	483C-390	043A-390	153A-390	483A-390	043i-390	153i-390	483i-390
	40.00	043T-400	153T-400	483T-400	043C-400	153C-400	483C-400	043A-400	153A-400	483A-400	043i-400	153i-400	483i-400
	41.00	043T-410	153T-410	483T-410	043C-410	153C-410	483C-410	043A-410	153A-410	483A-410	043i-410	153i-410	483i-410
	42.00	043T-420	153T-420	483T-420	043C-420	153C-420	483C-420	043A-420	153A-420	483A-420	043i-420	153i-420	483i-420
	43.00	043T-430	153T-430	483T-430	043C-430	153C-430	483C-430	043A-430	153A-430	483A-430	043i-430	153i-430	483i-430
	44.00	043T-440	153T-440	483T-440	043C-440	153C-440	483C-440	043A-440	153A-440	483A-440	043i-440	153i-440	483i-440
	45.00	043T-450	153T-450	483T-450	043C-450	153C-450	483C-450	043A-450	153A-450	483A-450	043i-450	153i-450	483i-450
	46.00	043T-460	153T-460	483T-460	043C-460	153C-460	483C-460	043A-460	153A-460	483A-460	043i-460	153i-460	483i-460
47.00	043T-470	153T-470	483T-470	043C-470	153C-470	483C-470	043A-470	153A-470	483A-470	043i-470	153i-470	483i-470	

HSS

SPADE DRILL INSERTS

Stock Item
(Marked Yellow)

AVAILABLE IN
FRACTION SIZES

METRIC (mm)	TiN 			TiCN 			TiAlN 			ALTiN 		
	HSS(M4)	SUPER HSS (T-15)	PREMIUM HSS (M48)	HSS(M4)	SUPER HSS (T-15)	PREMIUM HSS (M48)	HSS(M4)	SUPER HSS (T-15)	PREMIUM HSS (M48)	HSS(M4)	SUPER HSS (T-15)	PREMIUM HSS (M48)
48.00	044T-480	154T-480	484T-480	044C-480	154C-480	484C-480	044A-480	154A-480	484A-480	044i-480	154i-480	484i-480
49.00	044T-490	154T-490	484T-490	044C-490	154C-490	484C-490	044A-490	154A-490	484A-490	044i-490	154i-490	484i-490
50.00	044T-500	154T-500	484T-500	044C-500	154C-500	484C-500	044A-500	154A-500	484A-500	044i-500	154i-500	484i-500
51.00	044T-510	154T-510	484T-510	044C-510	154C-510	484C-510	044A-510	154A-510	484A-510	044i-510	154i-510	484i-510
52.00	044T-520	154T-520	484T-520	044C-520	154C-520	484C-520	044A-520	154A-520	484A-520	044i-520	154i-520	484i-520
53.00	044T-530	154T-530	484T-530	044C-530	154C-530	484C-530	044A-530	154A-530	484A-530	044i-530	154i-530	484i-530
54.00	044T-540	154T-540	484T-540	044C-540	154C-540	484C-540	044A-540	154A-540	484A-540	044i-540	154i-540	484i-540
55.00	044T-550	154T-550	484T-550	044C-550	154C-550	484C-550	044A-550	154A-550	484A-550	044i-550	154i-550	484i-550
56.00	044T-560	154T-560	484T-560	044C-560	154C-560	484C-560	044A-560	154A-560	484A-560	044i-560	154i-560	484i-560
57.00	044T-570	154T-570	484T-570	044C-570	154C-570	484C-570	044A-570	154A-570	484A-570	044i-570	154i-570	484i-570
58.00	044T-580	154T-580	484T-580	044C-580	154C-580	484C-580	044A-580	154A-580	484A-580	044i-580	154i-580	484i-580
59.00	044T-590	154T-590	484T-590	044C-590	154C-590	484C-590	044A-590	154A-590	484A-590	044i-590	154i-590	484i-590
60.00	044T-600	154T-600	484T-600	044C-600	154C-600	484C-600	044A-600	154A-600	484A-600	044i-600	154i-600	484i-600
61.00	044T-610	154T-610	484T-610	044C-610	154C-610	484C-610	044A-610	154A-610	484A-610	044i-610	154i-610	484i-610
62.00	044T-620	154T-620	484T-620	044C-620	154C-620	484C-620	044A-620	154A-620	484A-620	044i-620	154i-620	484i-620
63.00	044T-630	154T-630	484T-630	044C-630	154C-630	484C-630	044A-630	154A-630	484A-630	044i-630	154i-630	484i-630
64.00	044T-640	154T-640	484T-640	044C-640	154C-640	484C-640	044A-640	154A-640	484A-640	044i-640	154i-640	484i-640
65.00	044T-650	154T-650	484T-650	044C-650	154C-650	484C-650	044A-650	154A-650	484A-650	044i-650	154i-650	484i-650
63.50	045T-635			045C-635			045A-635					
64.00	045T-640			045C-640			045A-640					
66.00	045T-660			045C-660			045A-660					
68.00	045T-680			045C-680			045A-680					
70.00	045T-700			045C-700			045A-700					
72.00	045T-720			045C-720			045A-720					
74.00	045T-740			045C-740			045A-740					
76.00	045T-760			045C-760			045A-760					
78.00	046T-780			046C-780			046A-780					
80.00	046T-800			046C-800			046A-800					
82.00	046T-820			046C-820			046A-820					
84.00	046T-840			046C-840			046A-840					
86.00	046T-860			046C-860			046A-860					
88.00	046T-880			046C-880			046A-880					
90.00	047T-900			047C-900			047A-900					
92.00	047T-920			047C-920			047A-920					
94.00	047T-940			047C-940			047A-940					
96.00	047T-960			047C-960			047A-960					
100.00	047T-1000			047C-1000			047A-1000					
102.00	048T-1020			048C-1020			048A-1020					
104.00	048T-1040			048C-1040			048A-1040					
106.00	048T-1060			048C-1060			048A-1060					
108.00	048T-1080			048C-1080			048A-1080					
110.00	048T-1100			048C-1100			048A-1100					
112.00	048T-1120			048C-1120			048A-1120					
114.00	048T-1140			048C-1140			048A-1140					

SPADE DRILL INSERTS

Carbide(P25)

SPADE DRILL INSERTS

TiALN



METRIC (mm)	
95	C5YA0950
100	C5YA1000
105	C5YA1050
110	C5YA1100
115	C5ZA1150
120	C5ZA1200
125	C5ZA1250
130	C50A1300
135	C50A1350
140	C50A1400
145	C50A1450
150	C50A1500
155	C50A1550
160	C50A1600
165	C50A1650
170	C50A1700
175	C50A1750
180	C51A1800
185	C51A1850
190	C51A1900
195	C51A1950
200	C51A2000
205	C51A2050
210	C51A2100
215	C51A2150
220	C51A2200
225	C51A2250
230	C51A2300
235	C51A2350
240	C51A2400
250	C52A2500
260	C52A2600
270	C52A2700
280	C52A2800
290	C52A2900
300	C52A3000
310	C52A3100
320	C52A3200

AVAILABLE IN FRACTION SIZES

TiALN



METRIC (mm)	
330	C52A3300
340	C52A3400
350	C52A3500
370	C53A3700
380	C53A3800
390	C53A3900
400	C53A4000
410	C53A4100
420	C53A4200
430	C53A4300
440	C53A4400
450	C53A4500
460	C53A4600
470	C53A4700
480	C54A4800
490	C54A4900
500	C54A5000
510	C54A5100
520	C54A5200
530	C54A5300
540	C54A5400
550	C54A5500
560	C54A5600
570	C54A5700
580	C54A5800
590	C54A5900
600	C54A6000
610	C54A6100
620	C54A6200
630	C54A6300
640	C54A6400
650	C54A6500

LIVETOOLS®

Machine Tool People.
www.livetools.com.au

HSS

(B7 DRILL CUTTING DATA)

METRIC	HARDNESS (Bhn)	* HSS GRADE	SPEED			FEED						
			TiN	TiCN	TiAlN	Ø9.5~ Ø12.5	Ø13~ Ø17.5	Ø18~ Ø24.5	Ø25~ Ø35.5	Ø36~ Ø47.5	Ø48~ Ø65.5	Ø64~ Ø114
FREE MACHINING STEEL	100-150	M4	56.7	71.1	75.6	0.18	0.25	0.33	0.41	0.51	0.58	0.71
	150-200	M4	52.2	63	72.9	0.18	0.25	0.33	0.41	0.51	0.58	0.71
	200-250	M4	45.9	59.4	64.8	0.15	0.25	0.33	0.41	0.51	0.58	0.71
LOW CARBON STEEL	85-125	M4	48.6	60.3	67.5	0.15	0.23	0.31	0.38	0.48	0.58	0.69
	125-175	M4	45.9	56.7	64.8	0.15	0.23	0.31	0.38	0.48	0.58	0.69
	175-225	M4	44.1	52.2	62.1	0.13	0.20	0.25	0.36	0.46	0.53	0.61
	225-275	M4	40.5	50.4	59.4	0.13	0.20	0.25	0.36	0.46	0.53	0.61
MEDIUM CARBON STEEL	125-175	M4	46.8	56.7	67.5	0.15	0.23	0.31	0.38	0.48	0.58	0.69
	175-225	M4	43.2	53.1	62.1	0.13	0.20	0.25	0.36	0.46	0.53	0.61
	225-275	M4	40.5	50.4	56.7	0.13	0.20	0.25	0.36	0.46	0.53	0.61
	275-325	T15,M48	37.8	46.8	52.2	0.10	0.18	0.23	0.31	0.41	0.48	0.56
STRUCTURAL STEEL	100-150	M4	39.6	50.4	56.7	0.15	0.25	0.31	0.36	0.46	0.53	0.66
	150-250	M4	35.1	42.3	49.5	0.17	0.23	0.25	0.31	0.41	0.48	0.61
	250-350	T15,M48	28.8	36.9	36.9	0.10	0.20	0.23	0.25	0.36	0.43	0.51
CAST IRON/S.G IRON	120-150	M4	46.8	57.6	67.5	0.18	0.30	0.41	0.51	0.61	0.69	0.76
	150-200	M4	43.2	52.2	63	0.15	0.28	0.36	0.46	0.56	0.64	0.71
	200-220	M4	37.8	47.7	52.2	0.15	0.23	0.31	0.41	0.46	0.53	0.61
	220-260	T15,M48	31.5	39.6	46.8	0.13	0.18	0.23	0.31	0.36	0.43	0.51
	260-320	T15,M48	26.1	31.5	36.9	0.10	0.15	0.18	0.23	0.31	0.36	0.41
ALLOY STEEL	125-175	M4	43.2	52.2	56.7	0.15	0.20	0.25	0.36	0.43	0.48	0.56
	175-225	M4	40.5	50.4	52.2	0.13	0.20	0.25	0.36	0.43	0.48	0.56
	225-275	M4	36.9	45	50.4	0.13	0.18	0.25	0.36	0.43	0.48	0.56
	275-325	T15,M48	35.1	42.3	47.7	0.10	0.15	0.23	0.31	0.38	0.43	0.51
	325-375	T15,M48	32.4	38.7	41.4	0.08	0.15	0.23	0.31	0.38	0.43	0.51
TOOL STEEL	150-200	T15	22.5	30.6	30.6	0.10	0.15	0.20	0.25	0.31	0.38	0.43
	200-250	T15,M48	71.1	24.3	23.4	0.10	0.15	0.20	0.25	0.31	0.38	0.43
HIGH TEMP.ALLOY	140-220	T15,M48	9.9	9.9	10.8	0.08	0.18	0.20	0.25	0.31	0.38	-
	220-310	M48	9	8.1	9.9	0.08	0.15	0.18	0.20	0.25	0.31	-
	225-300	T15,M48	22.5	30.6	31.5	0.13	0.18	0.23	0.25	0.36	0.43	0.51
	300-350	T15,M48	17.1	23.4	24.3	0.10	0.18	0.23	0.25	0.36	0.43	0.51
	350-400	M48	14.4	18.9	18.9	0.08	0.15	0.20	0.23	0.31	0.38	0.46
ALUMINIUM	30	M4	168.3	206.1	221.6	0.20	0.33	0.41	0.51	0.56	0.64	0.64
	180	M4	82.8	123.3	123.3	0.20	0.33	0.41	0.46	0.56	0.64	0.64
STAINLESS STEEL	135-185	M4	21.6	26.1	30.6	0.15	0.20	0.23	0.28	0.36	0.41	0.51
	185-275	M4	18	20.7	26.1	0.13	0.18	0.20	0.25	0.36	0.36	0.46



CARBIDE

(B7 DRILL CUTTING DATA)

(B7 DRILL CUTTING DATA)

METRIC	HARDNESS (Bhn)	GRADE	SPEED			FEED				
			TIN	ALTIN	TICN	Ø9.5~ Ø12.5	Ø13~ Ø17.5	Ø18~ Ø24.5	Ø25~ Ø35.5	Ø36~ Ø47.5
FREE MACHINING STEEL	100-150	P40	96	128	115	0.20	0.30	0.38	0.45	0.53
	150-200	P40	85	110	100	0.18	0.28	0.35	0.40	0.48
	200-250	P40	79	104	90	0.15	0.25	0.33	0.38	0.43
LOW CARBON STEEL	85-125	P40	91	119	110	0.20	0.25	0.33	0.43	0.48
	125-175	P40	79	104	90	0.18	0.25	0.33	0.40	0.45
	175-225	P40	73	95	82	0.15	0.23	0.30	0.38	0.43
MEDIUM CARBON STEEL	225-275	P40	64	83	75	0.13	0.23	0.30	0.38	0.43
	125-175	P40	79	104	90	0.18	0.25	0.33	0.40	0.45
	175-225	P40	73	95	84	0.15	0.23	0.30	0.38	0.43
ALLOY STEEL	225-275	P40	67	83	72	0.15	0.23	0.30	0.38	0.43
	275-325	P40	55	70	62	0.13	0.20	0.28	0.35	0.40
	125-175	P40	76	99	87	0.18	0.25	0.33	0.40	0.45
HIGH STRENGTH ALLOY	175-225	P40	70	92	80	0.15	0.23	0.30	0.38	0.43
	225-275	P40	64	83	72	0.15	0.23	0.30	0.38	0.43
	275-325	P40	61	76	68	0.13	0.20	0.28	0.35	0.40
STRUCTURAL STEEL	325-375	P40	52	67	60	0.10	0.18	0.25	0.33	0.38
	225-300	P40	49	61	55	0.15	0.23	0.25	0.30	0.38
	300-350	P40	43	55	49	0.13	0.20	0.23	0.28	0.35
HIGH TEMP ALLOY	350-400	P40	37	49	43	0.10	0.18	0.20	0.25	0.30
	100-150	P40	73	95	84	0.20	0.28	0.35	0.40	0.45
	150-250	P40	61	76	68	0.15	0.25	0.30	0.35	0.40
STAINLESS STEEL	250-350	P40	55	70	62	0.13	0.23	0.28	0.30	0.35
	140-220	K20	24	32	28	0.10	0.18	0.23	0.28	0.33
	220-310	K20	18	26	22	0.10	0.15	0.20	0.25	0.30
TOOL STEEL	135-185	K20	49	64	57	0.18	0.23	0.30	0.35	0.40
	185-275	K20	37	49	43	0.15	0.20	0.28	0.30	0.35
	150-200	P40	49	67	58	0.10	0.18	0.23	0.28	0.33
ALUMINIUM	200-250	P40	37	52	45	0.10	0.18	0.23	0.28	0.33
	30	K20	366	460	410	0.25	0.38	0.45	0.50	0.55
	180	K20	244	306	275	0.23	0.33	0.40	0.45	0.50
CAST IRON/S.G IRON	120-150	K20,K10*	98	141	127	0.20	0.30	0.38	0.48	0.58
	150-200	K20,K10*	82	122	102	0.18	0.28	0.33	0.43	0.53
	200-220	K20,K10*	73	110	93	0.15	0.23	0.30	0.38	0.45
	220-260	K20,K10*	64	95	79	0.13	0.20	0.28	0.33	0.38
	260-320	K20,K10*	55	83	69	0.13	0.18	0.28	0.28	0.33

(B7 HOLDER ITEM NUMBER)

B7 S - 115 125 134 A

(SPADE DRILL HOLDER)

(SHANK STRAIGHT, FLUTE STRAIGHT)

(SHANK STRAIGHT, FLUTE SPIRAL)

(SHANK MORSE TAPER, FLUTE STRAIGHT)

(SHANK MORSE TAPER, FLUTE SPIRAL)

(MINIMUM FITTING DIAMETER)

(MAXIMUM FITTING DIAMETER)

(TOTAL LENGTH)

(SHANK Ø40)

(SHANK Ø42)

(B7 HOLDER ITEM NUMBER)

B7K (FLANGE SHANK / STRAIGHT FLUTE TYPE)

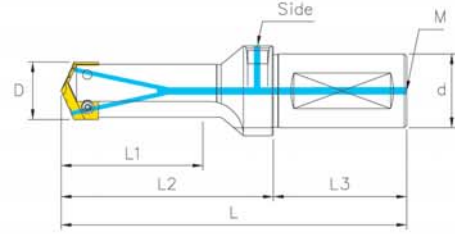

B7K

ORDER. NO.	DIMENSION				SHANK				Screw	TXL
	D	L	L1	L2	d	L3	M	SIDE		
B7K - 095110092	9.5-11.0	91.9	19.9	50	16.0	41.9	1/16"	1/8"	BS7 - 20040	TXL-7
B7K - 115125092	11.5-12.5	91.9	19.9	50	16.0	41.9	1/16"	1/8"	BS7 - 20050	
B7K - 130175092	13.0-17.5	92.3	22.2	50.4	20.0	41.9	1/8"	1/8"	BS7 - 25060	TXL-8
B7K - 155175092	15.5-17.5	92.3	22.2	50.4	20.0	41.9	1/8"	1/8"		
B7K - 180240133	18.0-24.0	132.5	47.6	79.4	25.0	53.1	1/8"	1/8"	BS7 - 30070	TXL-9
B7K - 220240145	22.0-24.0	145.2	57.2	92.1	25.0	53.1	1/8"	1/8"		
B7K - 250350150	25.0-35.0	150.0	57.2	92.1	32.0	57.9	1/4"	1/8"	BS7 - 40095	TXL-15

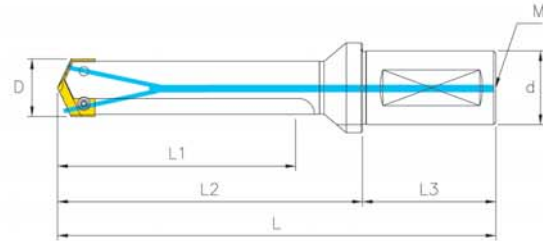

B7K

ORDER. NO.	DIMENSION				SHANK			Screw	TXL
	D	L	L1	L2	d	L3	M		
B7K - 095110105	9.5-11.0	105.4	31.8	63.5	20	41.9	1/8"		
B7K - 095110296	9.5-11.0	296	222	254.1	20	41.9	1/8"	BS7 - 20040	
B7K - 095110364	9.5-11.0	364.2	290	322.3	20	41.9	1/8"		TXL-7
B7K - 115125105	11.5-12.5	105.4	31.8	63.5	20	41.9	1/8"		
B7K - 115125296	11.5-12.5	296	222.3	254.1	20	41.9	1/8"	BS7 - 20050	
B7K - 115125364	11.5-12.5	364.2	290.5	322.3	20	41.9	1/8"		
B7K - 130175108	13.0-17.5	108.2	34.9	66.3	20	41.9	1/8"		
B7K - 130175369	13.0-17.5	368.6	295	326.7	20	41.9	1/8"		
B7K - 130175461	13.0-17.5	460.7	387	418.8	20	41.9	1/8"	BS7 - 25060	TXL-8
B7K - 155175108	15.5-17.5	108.2	34.9	66.3	20	41.9	1/8"		
B7K - 180240164	18.0-24.0	163.8	66.7	110.7	25	53.1	1/8"		
B7K - 180240551	18.0-24.0	551.2	457	498.1	25	53.1	1/8"		
B7K - 180240659	18.0-24.0	659.2	569	606.1	25	53.1	1/8"	BS7 - 30070	TXL-9
B7K - 220240164	22.0-24.0	163.8	66.7	110.7	25	53.1	1/8"		
B7K - 250350190	25.0-35.0	190.1	85.7	132.2	32	57.9	1/4"		
B7K - 250350616	25.0-35.0	615.6	511	557.7	32	57.9	1/4"		
B7K - 250350797	25.0-35.0	796.6	692	738.7	32	57.9	1/4"	BS7 - 40095	TXL-15
B7K - 300350190	30.0-35.0	190.1	85.7	132.2	32	57.9	1/4"		
B7K - 360470248A	36.0-47.0	247.9	120.7	177.8	40	70.1	1/4"		
B7K - 360470248B	36.0-47.0	247.9	120.7	177.8	42	70.1	1/4"		
B7K - 360470476A	36.0-47.0	476.5	349.3	406.4	40	70.1	1/4"		
B7K - 360470686	36.0-47.0	686	611.1	616	40	70	1/4"		
B7K - 360470476B	36.0-47.0	476.5	349.3	406.4	42	70.1	1/4"		
B7K - 480650254A	48.0-65.0	254.3	130.2	184.2	40	70.1	1/4"		
B7K - 480650254B	48.0-65.0	254.3	130.2	184.2	42	70.1	1/4"		
B7K - 480650546A	48.0-65.0	546.4	422.3	476.3	40	70.1	1/4"	BS7 - 50150	TXL-20
B7K - 480650546B	48.0-65.0	546.4	422.3	476.3	42	70.1	1/4"		
B7K - 480650750	48.0-65.0	749.6	625	679.6	40	70	1/4"		

B7S (FLANGE SHANK / SPIRAL FLUTE TYPE)

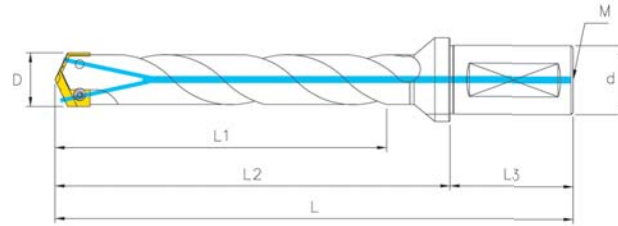

B7S

ORDER. NO.	DIMENSION				SHANK			Screw	TXL
	D	L	L1	L2	d	L3	M		
B7S - 095110134	9.5-11.0	134.0	60.3	92.1	20.0	41.9	1/8"	BS7 - 20040	TXL-7
B7S - 095110185	9.5-11.0	184.8	111.1	142.9	20.0	41.9	1/8"		
B7S - 115125134	11.5-12.5	134.0	60.3	92.1	20.0	41.9	1/8"		
B7S - 115125185	11.5-12.5	184.8	111.1	142.9	20.0	41.9	1/8"		
B7S - 130175137	13.0-17.5	136.8	63.5	94.9	20.0	41.9	1/8"	BS7 - 25060	TXL-8
B7S - 130175188	13.0-17.5	187.6	114.3	145.7	20.0	41.9	1/8"		
B7S - 130175251	13.0-17.5	251	177.8	209.1	20.0	41.9	1/8"		
B7S - 155175137	15.5-17.5	136.8	63.5	94.9	20.0	41.9	1/8"		
B7S - 155175188	15.5-17.5	187.6	114.3	145.7	20.0	41.9	1/8"	BS7 - 30070	TXL-9
B7S - 155175251	15.5-17.5	251	177.8	209.1	20.0	41.9	1/8"		
B7S - 180240212	18.0-24.0	211.5	117.5	158.4	25.0	53.1	1/8"		
B7S - 180240262	18.0-24.0	262.3	168.3	209.2	25.0	53.1	1/8"		
B7S - 180240364	18.0-24.0	363.9	269.9	310.8	25.0	53.1	1/8"	BS7 - 40095	TXL-15
B7S - 220240212	22.0-24.0	211.5	117.5	158.4	25.0	53.1	1/8"		
B7S - 220240262	22.0-24.0	262.3	168.3	209.2	25.0	53.1	1/8"		
B7S - 220240364	22.0-24.0	363.9	269.9	310.8	25.0	53.1	1/8"		
B7S - 250350241	25.0-35.0	240.9	136.5	183.0	32.0	57.9	1/4"	BS7 - 50150	TXL-20
B7S - 250350292	25.0-35.0	291.7	187.3	233.8	32.0	57.9	1/4"		
B7S - 250350393	25.0-35.0	393.3	288.9	335.4	32.0	57.9	1/4"		
B7S - 300350241	30.0-35.0	240.9	136.5	183.0	32.0	57.9	1/4"		
B7S - 300350292	30.0-35.0	291.7	187.3	233.8	32.0	57.9	1/4"	BS7 - 50150	TXL-20
B7S - 300350393	30.0-35.0	393.3	288.9	335.4	32.0	57.9	1/4"		
B7S - 360470292A	36.0-47.0	292.4	165.1	222.3	40.0	70.1	1/4"		
B7S - 360470292B	36.0-47.0	292.4	165.1	222.3	42.0	70.1	1/4"		
B7S - 360470337A	36.0-47.0	336.8	209.6	266.7	40.0	70.1	1/4"	BS7 - 50150	TXL-20
B7S - 360470337B	36.0-47.0	336.8	209.6	266.7	42.0	70.1	1/4"		
B7S - 480650356A	48.0-65.0	355.9	231.8	285.8	40.0	70.1	1/4"		
B7S - 480650356B	48.0-65.0	355.9	231.8	285.8	42.0	70.1	1/4"		

B7S (FLANGE SHANK / SPIRAL FLUTE TYPE)

B7H (TAPER SHANK / STRAIGHT FLUTE TYPE)

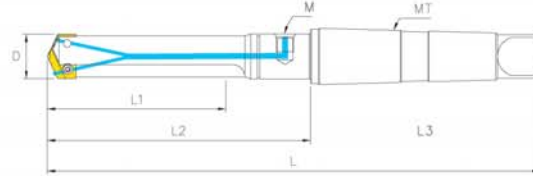

B7H

ORDER. NO.	DIMENSION								
	D	L	L1	L2	MT	M			
B7H - 095110163	9.5-11.0	162.9	31.8	88.0	#2	1/16"	COS - 190522	BS7 - 20040	TXL-7
B7H - 115125163	11.5-12.5	162.9	31.8	88.0	#2	1/16"		BS7 - 20050	
B7H - 130175167	13.0-17.5	167.1	35.0	92.4	#2	1/16"	COS - 254028	BS7 - 25060	TXL-8
B7H - 155175167	15.5-17.5	167.1	35.0	92.4	#2	1/16"		BS7 - 30070	
B7H - 180240236	18.0-24.0	236.1	69.8	142.5	#3	1/8"	COS - 317535	BS7 - 40095	TXL-9
B7H - 220240236	22.0-24.0	236.1	69.8	142.5	#3	1/8"		BS7 - 40095	
B7H - 250350277	25.0-35.0	277.4	85.7	160.4	#4	1/8"	COS - 444535	BS7 - 40095	TXL-15
B7H - 300350285	30.0-35.0	284.6	85.7	167.6	#4	1/4"		BS7 - 50150	
B7H - 360470323	36.0-47.0	322.7	120.6	206.4	#4	1/4"	COS - 571544	BS7 - 50150	TXL-20
B7H - 360470553	36.0-47.0	552.5	349.3	435.0	#4	1/4"		BS7 - 60190	
B7H - 360470676	36.0-47.0	676	472.8	555	#4	1/4"	COS - 571544	BS7 - 60190	TXL-25
B7H - 480650368	48.0-65.0	368.3	130.1	219.1	#5	1/4"		BS7 - 60190	
B7H - 480650660	48.0-65.0	660.4	422.3	511.2	#5	1/4"	COS - 571544	BS7 - 60190	TXL-25
B7H - 640880435	64.0-88.0	435.0	171.5	287.3	#5	1/2"		BS7 - 60190	
B7H - 640880727	64.0-88.0	727.1	463.6	579.4	#5	1/2"	COS - 571544	BS7 - 60190	TXL-25
B7H - 9001140445	90.0-114.0	444.5	171.5	296.8	#5	1/2"		BS7 - 60190	
B7H - 9001140829	90.0-114.0	828.7	555.6	681.1	#5	1/2"			

B7M (TAPER SHANK / SPIRAL FLUTE TYPE)

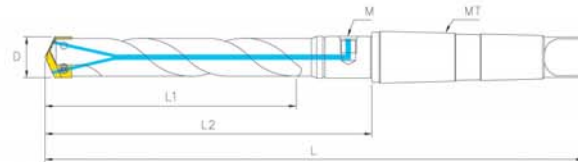



B7M

ORDER. NO.	DIMENSION								
	D	L	L1	L2	MT	M			
B7M - 095110191	9.5-11.0	191.3	60.3	116.7	#2	1/16"	COS - 190522	BS7 - 20040	TXL-7
B7M - 095110242	9.5-11.0	242.1	111.1	167.4	#2	1/16"		BS7 - 20050	
B7M - 115125191	11.5-12.5	191.3	60.3	116.7	#2	1/16"	COS - 254028	BS7 - 25065	TXL-8
B7M - 115125242	11.5-12.5	242.1	111.1	167.4	#2	1/16"		BS7 - 30070	
B7M - 130175196	13.0-17.5	195.7	63.5	121.0	#2	1/16"	COS - 317535	BS7 - 40095	TXL-9
B7M - 130175247	13.0-17.5	246.5	114.3	171.8	#2	1/16"		BS7 - 40095	
B7M - 130175310	13.0-17.5	310.3	177.8	235.3	#2	1/16"	COS - 444535	BS7 - 50150	TXL-20
B7M - 155175196	15.5-17.5	195.7	63.5	121.0	#2	1/16"		BS7 - 60190	
B7M - 155175247	15.5-17.5	246.5	114.3	171.8	#2	1/16"	COS - 571544	BS7 - 60190	TXL-25
B7M - 155175310	13.0-17.5	310.3	177.8	235.3	#2	1/16"		BS7 - 60190	
B7M - 180240287	18.0-24.0	286.9	120.7	193.3	#3	1/8"	COS - 571544	BS7 - 60190	TXL-25
B7M - 180240338	18.0-24.0	337.8	171.5	244.1	#3	1/8"		BS7 - 60190	
B7M - 180240439	18.0-24.0	439.4	273.1	345.7	#3	1/8"	COS - 571544	BS7 - 60190	TXL-25
B7M - 220240287	22.0-24.0	286.9	120.7	193.3	#3	1/8"		BS7 - 60190	
B7M - 220240338	22.0-24.0	337.8	171.5	244.1	#3	1/8"	COS - 571544	BS7 - 60190	TXL-25
B7M - 220240439	22.0-24.0	439.4	273.1	345.7	#3	1/8"		BS7 - 60190	
B7M - 250350328	25.0-35.0	328.2	136.5	211.2	#4	1/8"	COS - 571544	BS7 - 60190	TXL-25
B7M - 250350379	25.0-35.0	379.0	187.3	262.0	#4	1/8"		BS7 - 60190	
B7M - 250350481	25.0-35.0	480.6	289.0	363.6	#4	1/8"	COS - 571544	BS7 - 60190	TXL-25
B7M - 300350335	30.0-35.0	335.4	136.5	218.4	#4	1/4"		BS7 - 60190	
B7M - 300350386	30.0-35.0	386.2	187.3	269.2	#4	1/4"	COS - 571544	BS7 - 60190	TXL-25
B7M - 300350488	30.0-35.0	487.8	289.0	370.8	#4	1/4"		BS7 - 60190	
B7M - 360470368	36.0-47.0	368.4	165.1	250.9	#4	1/4"	COS - 571544	BS7 - 60190	TXL-25
B7M - 360470413	36.0-47.0	412.8	209.5	295.3	#4	1/4"		BS7 - 60190	
B7M - 480650470	48.0-65.0	469.9	231.8	320.7	#5	1/4"	COS - 571544	BS7 - 60190	TXL-25
B7M - 640880537	64.0-88.0	536.6	273.1	388.9	#5	1/2"		BS7 - 60190	
B7M - 9001140546	90.0-114.0	546.1	273.1	398.5	#5	1/2"			

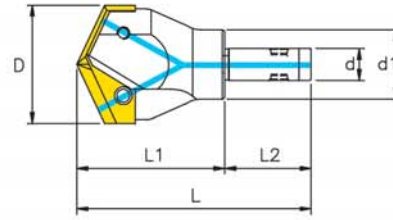
B7X (MODULAR HEAD)



B7X



ORDER. NO.	DIMENSION				SHANK			
	D	L	L1	d1	d	L2		
B7X - 36042050	36-42	80	50	20	10	30		
B7X - 42047050	42-47	80	50	24	12	30	BS7 - 50150	TXL - 20
B7X - 48065060	48-65	95	60	28	13	35		
B7X - 64077080	64-77	120	80	32	16	40		
B7X - 76090080	76-90	125	80	40	22	45		
B7X - 90010190	90-101	140	90	48	27	50	BS7 - 60190	TXL - 25
B7X - 10011490	100-114	140	90	58	32	50		

B7X (MODULAR HEAD)

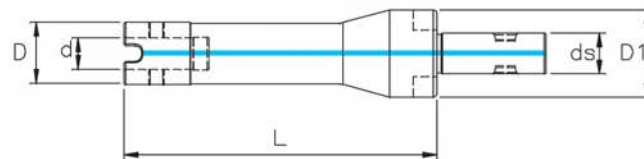
MUR (MODULAR REDUCER)



MUR

ORDER. NO.	DIMENSION							
	ds	d	L	D	D1			
MUR - 1310100	13	10	100	20	28	JTB - 05070	DKR - 201008	DKR - 281310
MUR - 1312100	13	12	100	24	28	JTB - 06080	DKR - 241208	DKR - 281310

12

LIVETOOLS®
Machine Tool People.
www.livetools.com.au

MUE (MODULAR EXTENSION)



MUE

ORDER. NO.	DIMENSION					
	D	d	L	ds		
MUE - 2010100	20	10	100	10	JTB - 05070	DKR - 201008
MUE - 2412100	24	12	100	12	JTB - 06080	DKR - 241208
MUE - 2813115	28	13	115	13		
MUE - 2813150	28	13	150	13		
MUE - 2813200	28	13	200	13	JTB - 08115	DKR - 281310
MUE - 2813300	28	13	300	13		
MUE - 3216115	32	16	115	16		
MUE - 3216200	32	16	200	16	JTB - 08115	DKR - 321610
MUE - 3216300	32	16	300	16		
MUE - 4022113	40	22	113	22		
MUE - 4022200	40	22	200	22	JTB - 10145	DKR - 402212
MUE - 4022300	40	22	300	22		
MUE - 4827113	48	27	113	27		
MUE - 4827200	48	27	200	27	JTB - 12175	DKR - 482712
MUE - 4827300	48	27	300	27		
MUE - 5832186	58	32	186	32		
MUE - 5832300	58	32	300	32	JTB - 12195	DKR - 583214

MUB (MODULAR FLANGED)

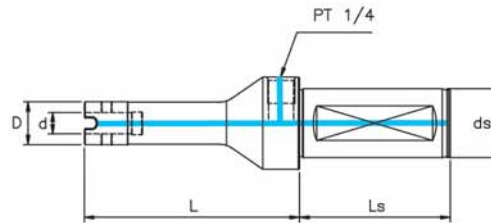

MUB

ORDER. NO.	DIMENSION			SHANK			
	D	d	L	ds	Ls		
MUB - 2010100	20	10	100	32	60	JTB - 05070	DKR - 201008
MUB - 2412100	24	12	100	32	60	JTB - 06080	DKR - 241208
MUB - 2813115	28	13	115	32			
MUB - 2813200	28	13	200	32	60	JTB - 08115	DKR - 281310
MUB - 2813300	28	13	300	32			
MUB - 3216125	32	16	125	40			
MUB - 3216200	32	16	200	40	70	JTB - 08115	DKR - 321610
MUB - 3216300	32	16	300	40			
MUB - 4022148	40	22	148	40			
MUB - 4022200	40	22	200	40	70	JTB - 10145	DKR - 402212
MUB - 4022300	40	22	300	40			
MUB - 4827168	48	27	168	40			
MUB - 4827300	48	27	300	40	70	JTB - 12175	DKR - 482712
MUB - 5832186	58	32	186	40			
MUB - 5832300	58	32	300	40	70	JTB - 12195	DKR - 583214

MXU (MODULAR BT ARBOR)

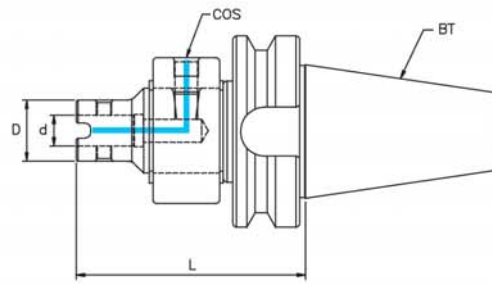



BT-M XU

ORDER. NO.	DIMENSION				
	D	d	L		
BT50 - MXU - 2813115	28	13	115	JTB-08115	COS-317535
BT50 - MXU - 3216120	32	16	120		
BT50 - MXU - 4022120	40	22	120	JTB-10145	COS-444535
BT50 - MXU - 4827130	48	27	130	JTB-12175	COS-571544
BT50 - MXU - 5732130	57	32	130	JTB-12195	

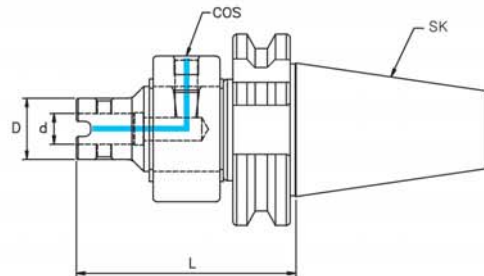
MXU (MODULAR SK ARBOR)



SK-M XU

ORDER. NO.	DIMENSION				
	D	d	L		
SK40 - MXU - 2813115	28	13	115	JTB-08115	COS-317535
SK40 - MXU - 3216120	32	16	120		
SK40 - MXU - 4022120	40	22	120	JTB-10145	COS-444535
SK40 - MXU - 4827130	48	27	130	JTB-12175	COS-571544
SK40 - MXU - 5732130	57	32	130	JTB-12195	
SK50 - MXU - 2813115	28	13	115	JTB-08115	COS-317535
SK50 - MXU - 3216120	32	16	120		
SK50 - MXU - 4022120	40	22	120	JTB-10145	COS-444535
SK50 - MXU - 4827130	48	27	130	JTB-12175	COS-571544
SK50 - MXU - 5732130	57	32	130	JTB-12195	

MXU (MODULAR NT ARBOR)

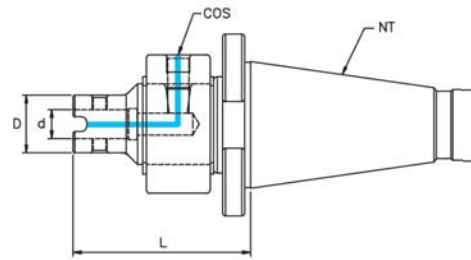

NT-MXU

ORDER. NO.	DIMENSION			JTB	COS	M
	D	d	L			
NT50 - MXU - 2813090	28	13	90	JTB - 08115	COS - 317535	1" - 8UNC
NT50 - MXU - 3216095	32	16	95		COS - 444535	
NT50 - MXU - 4022095	40	22	95	JTB - 10145	COS - 571544	
NT50 - MXU - 4827105	48	27	105	JTB - 12175	COS - 317535	
NT50 - MXU - 5732105	57	32	105	JTB - 12195	COS - 444535	
NT50 - MXU - 2813090M	28	13	90	JTB - 08115	COS - 317535	M24
NT50 - MXU - 3216095M	32	16	95	JTB - 10145	COS - 444535	
NT50 - MXU - 4022095M	40	22	95	JTB - 12175	COS - 571544	
NT50 - MXU - 4827105M	48	27	105	JTB - 12195	COS - 317535	
NT50 - MXU - 5732105M	57	32	105	JTB - 12195	COS - 444535	

MXU (MODULAR MT ARBOR)

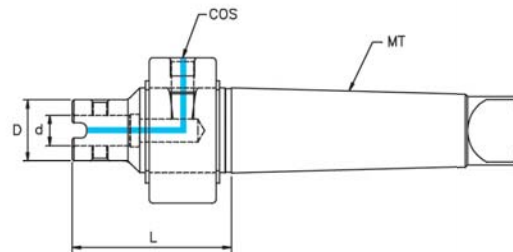

MT-MXU

ORDER. NO.	DIMENSION			JTB	COS	M
	D	d	L			
MT4 - MXU - 2813080	28	13	80	JTB-08115	COS - 317535	
MT5 - MXU - 2813080	28	13	80		COS - 444535	
MT6 - MXU - 2813095	28	13	95		COS - 571544	
MT4 - MXU - 3216080	32	16	80	JTB-08115	COS - 317535	
MT5 - MXU - 3216080	32	16	80		COS - 444535	
MT6 - MXU - 3216095	32	16	95		COS - 571544	
MT4 - MXU - 4022080	40	22	80	JTB-10145	COS - 317535	
MT5 - MXU - 4022080	40	22	80		COS - 444535	
MT6 - MXU - 4022095	40	22	95		COS - 571544	
MT5 - MXU - 4827095	48	27	95	JTB-12175	COS - 444535	
MT6 - MXU - 4827095	48	27	95		COS - 571544	
MT5 - MXU - 5732095	57	32	95		COS - 444535	
MT6 - MXU - 5732095	57	32	95	JTB-12195	COS - 571544	

COOLANT OIL SUPPLIER

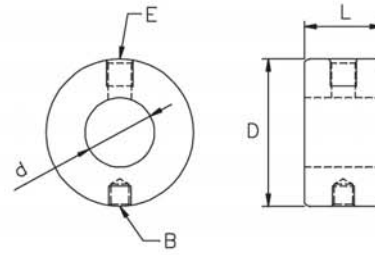

COS

ORDER. NO.	DIMENSION				
	d	D	L	B	E
COS - 190522	19.05	44.45	22.23	M8×1.25	1/8"
COS - 254028	25.40	53.97	28.57	M8×1.25	1/8"
COS - 317535	31.75	63.50	34.92	M10×1.5	1/4"
COS - 444535	44.45	76.20	34.92	M10×1.5	1/4"
COS - 571544	57.15	95.27	44.45	M12×1.75	1/2"

JOINT SCREW

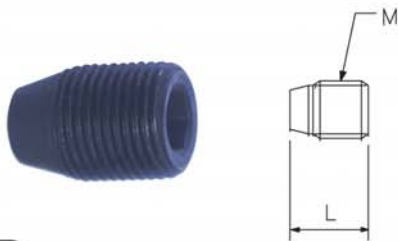

JTB

ORDER. NO.	DIMENSION		WRENCH
	M	L	
JTB - 05070	M5.0	7	2,5
JTB - 06080	M6.0	8	3
JTB - 08115	M8.0	11.5	4
JTB - 10145	M10.0	14.5	5
JTB - 12175	M12.0	17.5	6
JTB - 12195	M12.0	19.5	6

DRIVE KEY RING

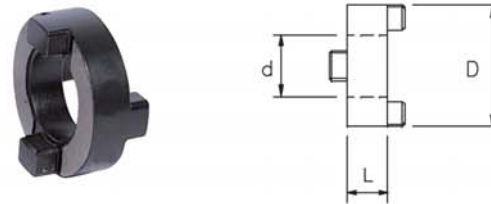

DKR

ORDER. NO.	DIMENSION		
	D	d	L
DKR - 201008	20	10	8
DKR - 241208	24	12	8
DKR - 281310	28	13	10
DKR - 321610	32	16	10
DKR - 402212	40	22	12
DKR - 482712	48	27	12
DKR - 583214	58	32	14

BSL

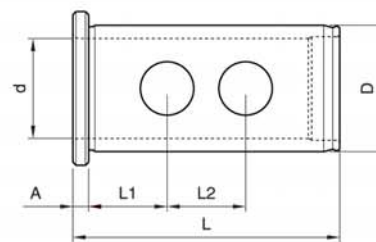

BSL

ORDER. NO.	DIMENSION					
	D	d	L	L1	L2	A
BSL-322065	32	20	65	20	-	5
BSL-322565	32	25	65	20	20	5
BSL-402075	40	20	75	20	-	5
BSL-402575	40	25	75	20	25	5
BSL-403275	40	32	75	20	25	5
BSL-502095	50	20	95	35	-	5
BSL-502595	50	25	95	35	-	5
BSL-503295	50	32	95	35	35	5
BSL-504095	50	40	95	35	35	5

BT-OAS

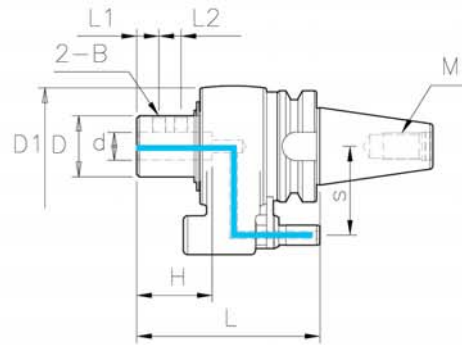

ORDER. NO.	DIMENSION									
	d	L	H	L1	L2	D	D1	B	M	S
BT40-OAS-20120	20	120	50	20		55	80	M12		
BT40-OAS-25140	25	140	60	20	20	55	80	M12	M16	65
BT40-OAS-32140	32	140	70	20	20	65	80	M14		
BT50-OAS-20145	20	145	50	20		55	100	M12		
BT50-OAS-25165	25	165	60	20	20	55	100	M12	M24	80
BT50-OAS-32165	32	165	70	20	20	65	100	M14		
BT50-OAS-40175	40	175	80	20	25	65	100	M16		

BT-OMS

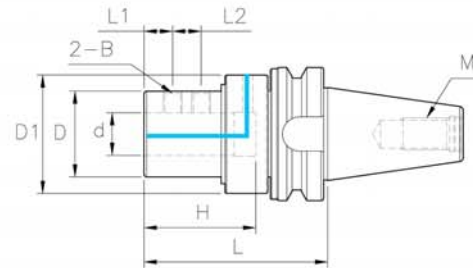

ORDER. NO.	DIMENSION									
	d	L	D	D1	H	L1	L2	B	M	S
BT40-OMS-20105	20	105	50	78	50	20	-	M12		
BT40-OMS-25120	25	120	50	78	60	20	20	M12	M16	
BT40-OMS-32125	32	125	65	88	70	20	20	M14		
BT50-OMS-20120	20	120	65	89	50	20	-	M12		
BT50-OMS-25135	25	135	65	89	60	20	20	M12		
BT50-OMS-32135	32	135	65	89	70	20	20	M14	M24	
BT50-OMS-40145	40	145	65	98	80	20	25	M16		
BT50-OMS-50170	50	170	90	123	90	35	35	M20		

NT-OMS

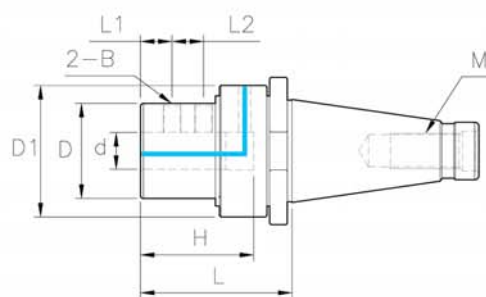

ORDER. NO.	DIMENSION								
	d	L	D	D1	H	L1	L2	B	M
NT40-OMS-20090	20	90	50	78	50	20	-	M12	5/8-11 UNC
NT40-OMS-25105	25	105	50	78	60	20	20	M12	
NT40-OMS-32110	32	110	65	88	70	20	20	M14	
NT50-OMS-20090	20	90	65	78	50	20	-	M12	1"-8 UNC
NT50-OMS-25105	25	105	65	78	60	20	20	M12	
NT50-OMS-32105	32	105	65	98	70	20	20	M14	
NT50-OMS-40120	40	120	65	98	80	20	25	M16	
NT50-OMS-50145	50	145	90	123	90	35	35	M20	
NT40-OMS-20090M	20	90	50	78	50	20	-	M12	M16
NT40-OMS-25105M	25	105	50	78	60	20	20	M12	
NT40-OMS-32110M	32	110	65	88	70	20	20	M14	
NT50-OMS-20090M	20	90	50	78	50	20	-	M12	M24
NT50-OMS-25105M	25	105	50	78	60	20	20	M12	
NT50-OMS-32105M	32	105	65	98	70	20	20	M14	
NT50-OMS-40120M	40	120	65	98	80	20	25	M16	
NT50-OMS-50145M	50	145	90	123	90	35	35	M20	

SK-OMS

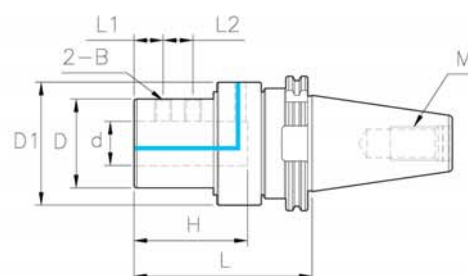

ORDER. NO.	DIMENSION								
	d	L	D	D1	H	L1	L2	B	M
SK40-OMS-20110	20	110	50	78	50	20	-	M12	M16
SK40-OMS-25125	25	125	50	78	60	20	20	M12	
SK40-OMS-32130	32	130	65	88	70	20	20	M14	
SK50-OMS-20105	20	105	65	78	50	20	-	M12	M24
SK50-OMS-25120	25	120	65	78	60	20	20	M12	
SK50-OMS-32125	32	125	65	98	70	20	20	M14	
SK50-OMS-40135	40	135	65	98	80	20	25	M16	
SK50-OMS-50165	50	165	90	123	90	35	35	M20	

MT-OMS

ARBOR (SIDE LOCK ARBOR)

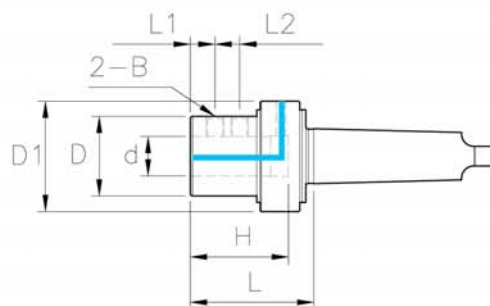

ORDER. NO.	DIMENSION							
	d	L	D	D1	H	L1	L2	B
MT4-OMS-20080	20	80	50	78	50	20	-	M12
MT4-OMS-25095	25	95	50	78	60	20	20	M12
MT4-OMS-32100	32	100	65	88	70	20	20	M14
MT5-OMS-20080	20	80	50	78	50	20	-	M12
MT5-OMS-25095	25	95	50	78	60	20	20	M12
MT5-OMS-32100	32	100	65	88	70	20	20	M14
MT5-OMS-40110	40	110	75	98	80	20	25	M16
MT5-OMS-50140	50	140	90	123	90	35	35	M20
MT6-OMS-20085	20	85	50	78	50	20	-	M12
MT6-OMS-25100	25	100	50	78	60	20	20	M12
MT6-OMS-32105	32	105	65	88	70	20	20	M14
MT6-OMS-40120	40	120	75	98	80	20	25	M16
MT6-OMS-50140	50	140	90	123	90	35	35	M20

BT-SLA

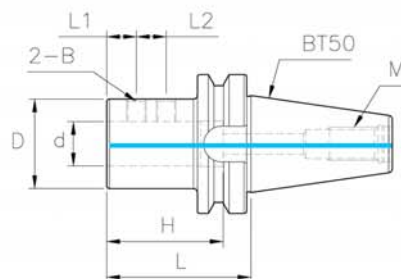

ORDER. NO.	DIMENSION							
	d	L	D	H	L1	L2	B	M
BT50-SLA-20105	20	105	50	50	20	-	M12	M24
BT50-SLA-25105	25	105	50	60	20	20	M12	
BT50-SLA-32105	32	105	65	70	20	20	M14	
BT50-SLA-40105	40	105	65	80	20	25	M16	

LIVETOOLS®
Machine Tool People.
www.livetools.com.au

NT-SLA

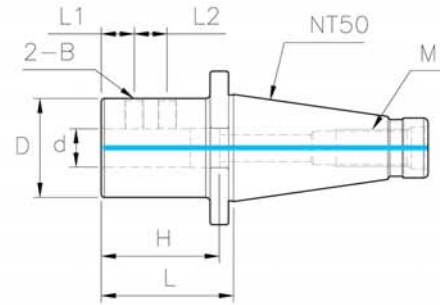

ORDER. NO.	DIMENSION							
	d	L	D	H	L1	L2	B	M
NT50-SLA-40090	40	90	65	80	20	25	M16	1" - 8UNC
NT50-SLA-40090M	40	90	65	80	20	25	M16	M24

SK-SLA

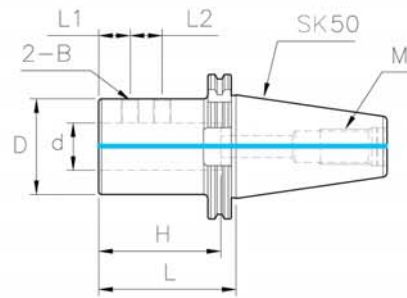

ORDER. NO.	DIMENSION							
	d	L	D	H	L1	L2	B	M
SK50-SLA-32105	32	105	65	70	20	25	M14	M24
SK50-SLA-40105	40	105	65	80	20	25	M16	

MT-SLA

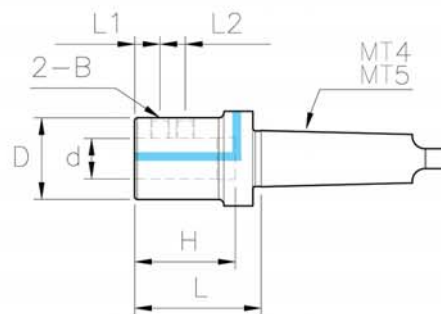

ORDER. NO.	DIMENSION						
	d	L	D	H	L1	L2	B
MT4-SLA-32105	32	105	65	70	20	20	M14
MT4-SLA-40105	40	105	65	80	20	25	M16
MT5-SLA-32105	32	105	65	70	20	20	M14
MT5-SLA-40105	40	105	65	80	20	25	M16
MT5-SLA-50130	50	130	90	90	35	35	M20

(SPARE PART)

(SPARE PART)

TYPE OF SCREW	PART NO.	DIMENSION		WRENCH	APPLICABLE HOLDER
		M	L		
	TSB-3508	M 3.5	8.0	TX - 15	CMN
	TSB - 0204	M 2.0	4.0	TX - 6	B2S
	TSB - 22060	M 2.2	6.0	TX - 6	
	TSB - 25065	M 2.5	6.5	TX - 7	
	TSB - 0307	M 3.0	7.0	TX - 9	
	TSB - 3508	M 3.5	8.0	TX - 15	
	TSB - 0410	M 4.0	10.0	TX - 15	
	TSB - 45110	M 4.5	11.0	TX - 20	
	TSB - 0204	M 2.0	4.0	TX - 6	B3S
	TSB - 25055M	M 2.5	5.5	TX - 8	
TSB - 0307	M 3.0	7.0	TX - 9		
TSB - 3508	M 3.5	8.0	TX - 15		
TSB - 0510	M 5.0	10.0	TX - 20	B4	
TSB - 20045	M 2.0	4.5	TX - 6		
TSB - 22060	M 2.2	6.0	TX - 6		
TSB - 25065	M 2.5	6.5	TX - 7		
TSB - 0408	M 4.0	8.0	TX - 15		
TSB - 0510	M 5.0	10.0	TX - 20		
TSB - 60120	M 6.0	12.0	TX - 25		
TSB - 18045	M 1.8	4.5	TX - 6	B5S	
TSB - 22060	M 2.2	6.0	TX - 6		
TSB - 25065	M 2.5	6.5	TX - 7		
TSB - 0307	M 3.0	7.0	TX - 9		
TSB - 3508	M 3.5	8.0	TX - 15		
TSB - 0410	M 4.0	10.0	TX - 15		
TSB - 0204	M 2.0	4.0	TX - 6	B6	
TSB - 22060	M 2.2	6.0	TX - 6		
TSB - 25065	M 2.5	6.5	TX - 7		
TSB - 3508	M 3.5	8.0	TX - 15		
TSB - 0410	M 4.0	10.0	TX - 15		
TSB - 243	M 5.0	11.0	TX - 20	B7	
BS7 - 20040	M 2.0	4.0	TX - 7		
BS7 - 20050	M 2.0	5.0	TX - 7		
BS7 - 25060	M 2.5	6.0	TX - 8		
BS7 - 30070	M 3.0	7.0	TX - 9		
BS7 - 40095	M 4.0	9.5	TX - 15		
BS7 - 50150	M 5.0	15.0	TX - 20		
BS7 - 60190	M 6.0	18.0	TX - 25	MUR, MUE, MUB	
JTB - 05070	M 5.0	7.0	L - 2.5		
JTB - 06080	M 6.0	8.0	L - 3.0		
JTB - 08115	M 8.0	11.5	L - 4.0		
JTB - 10145	M 10.0	14.5	L - 5.0		
JTB - 12175	M 12.0	17.5	L - 6.0		
JTB - 12195	M 12.0	19.5	L - 6.0		



DRILLING SYSTEM ASSEMBLY GUIDE (SIDE LOCK TYPE)

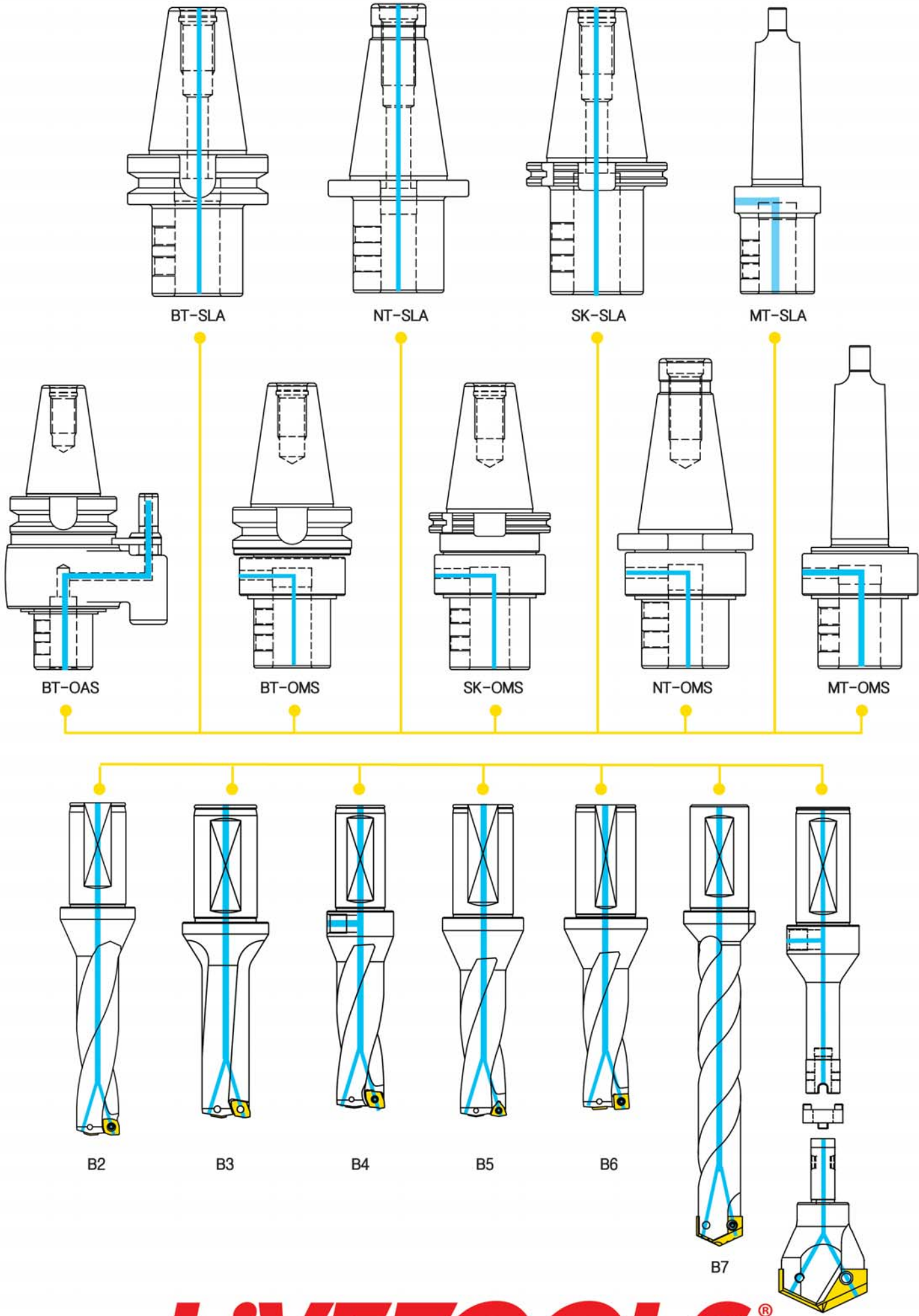

DRILLING SYSTEM ASSEMBLY GUIDE (MODULAR TYPE)

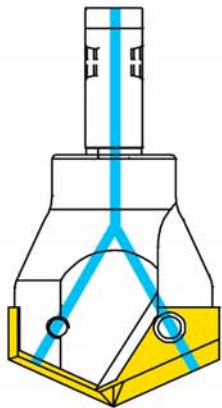
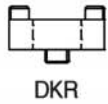
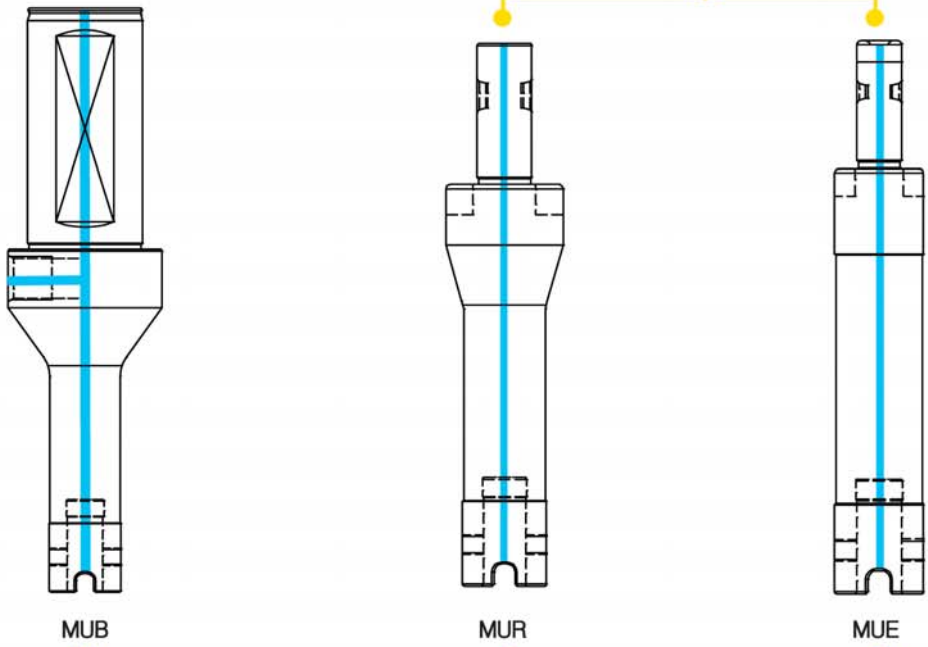
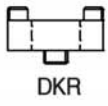
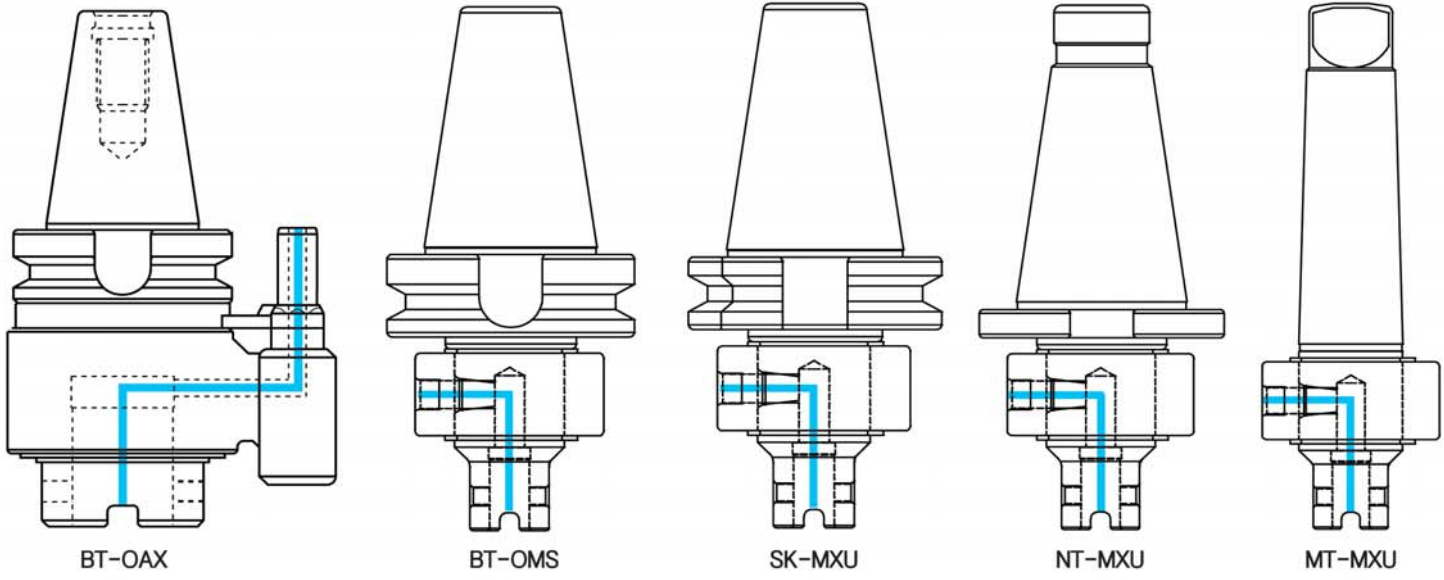

LIVETOOLS[®]

Machine Tool People.
www.livetools.com.au

 Sales@livetools.com.au

 www.livetools.com.au

Email: Sales@livetools.com.au

Web: www.livetools.com.au

Ph: +61 02 4017 0198

Address: 115 Young St Carrington NSW Australia 2294