

Quick jaw change

HG-F

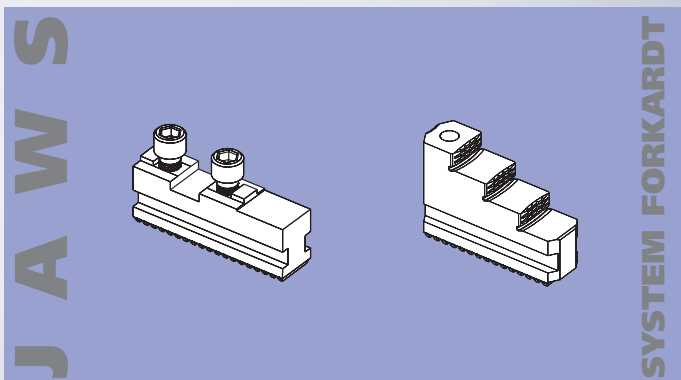

- Jaw change in less than 1 minute

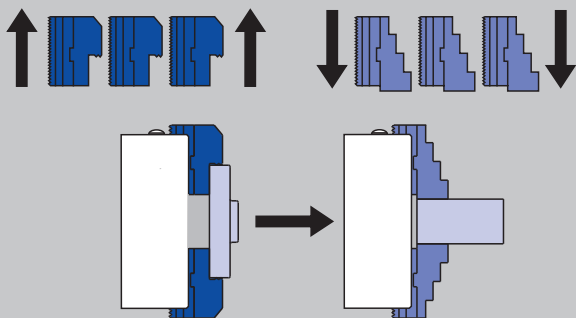

- Universal, because jaws can be radially adjusted and reversed = less jaw sets

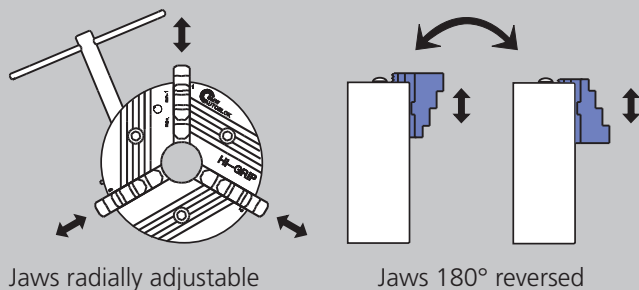

For highest speeds
Flat gripping force curve

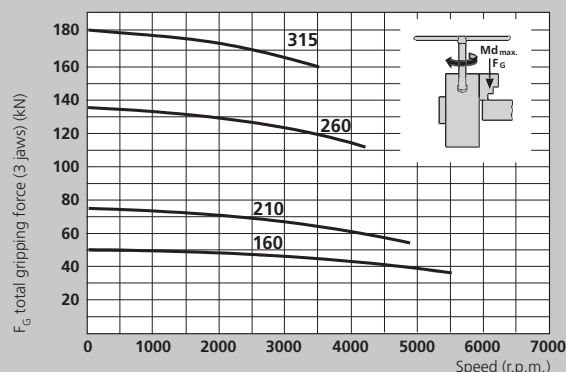

- The max. gripping force is the total, acting on the 3 jaws, obtained by applying to the chuck the max. allowed driving torque. The data refers to a chuck newly maintained accordingly to their service manual, using SMW K05 grease.

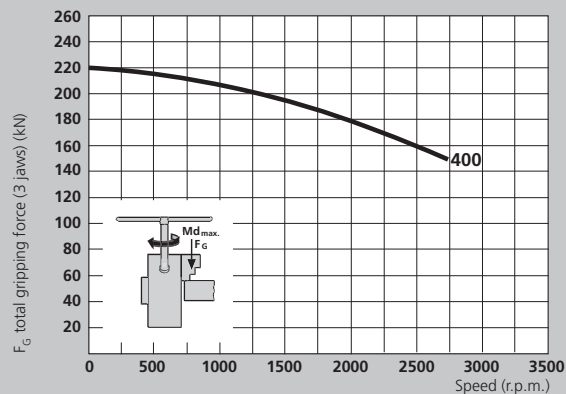

- The dynamic gripping forces have been measured using hardened standard stepped monoblock jaws type GST placed in a position not exceeding the outer diameter of the chuck.

⚠ Safety advice / danger of damage:

When using taller / heavier jaws and / or clamping on a more external position reduce driving torque / rotating speed accordingly.

manual chuck HI-GRIP®

Direct mounting

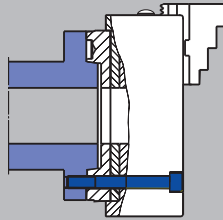

Recess and bolt circle to DIN 55026 / ISO-A 702/1

■ No re boring of already machined jaws necessary, because of runout < 0.02 (e.g. HG-F 210)

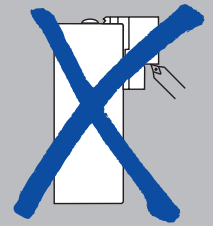

Wedge bar design guarantees highest precision, concentricity and repeatability as well as highest gripping forces

● Safety jaw release with interlock

● Jaw system "F" (compatible with Forkardt jaws)

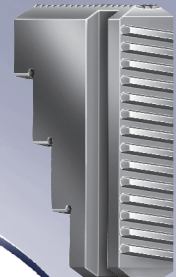
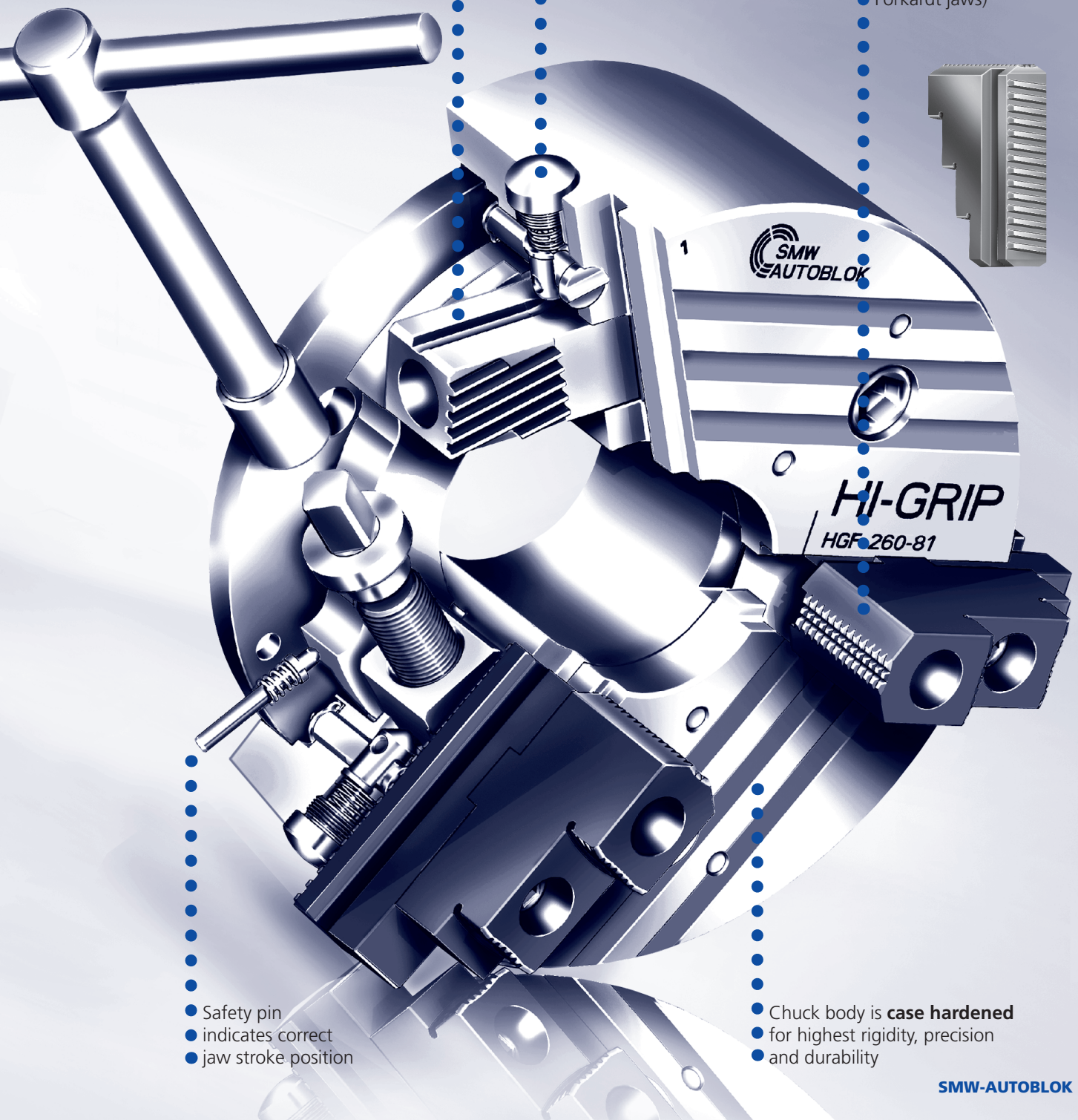

● Safety pin indicates correct jaw stroke position

● Chuck body is **case hardened** for highest rigidity, precision and durability

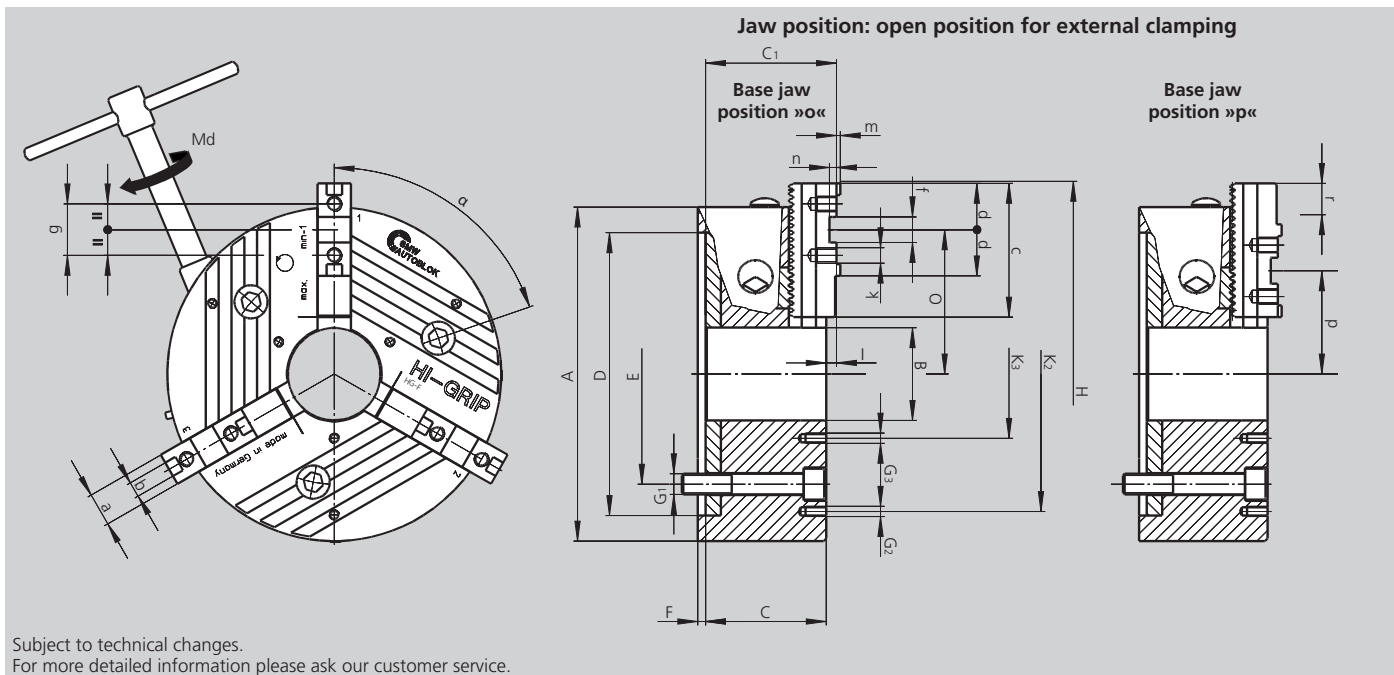

Subject to technical changes.
For more detailed information please ask our customer service.

SMW-AUTOBLOK Type HG-F		160-46	210-60	260-81	315-102	400-128
Mounting	Size	Z140	Z170	Z220	Z300	Z380
H6	A	165	210	260	315	400
	B	46	60	81	102	128
	C	64	85.5	94	111	132
	C1	71	92.7	101.7	120.1	141.9
	D	140	170	220	300	380
	E	104.8	133.4	171.4	235	330.2
	F	5	6	6	6	6
	G1	M10	M12	M16	M20	M24
	G2	-	M10 / 3 x 120°	M10 / 3 x 120°	M10 / 3 x 120°	M12 / 3 x 120°
	G3	M5 / 3 x 120°	M6 / 3 x 120°	M8 / 3 x 120°	M10 / 3 x 120°	M12 / 3 x 120°
Swing dia.	H	195	250	300	372	492
	K2	-	168	210	268	330
	K3	75	75	95	120	160
	α°	68	64	66	65.5	64.5
	β°	-	60	60	55	45
Master jaw		MFG 160	MFG 200	MFG 250	MFG 315	MFG 400
	a	20	22	26	32	45
f7	b	8	10	12	12	18
	c	74	90	110	125	160
	d	28	33	36	36	50
H7	f	18	20	20	26	30
	g	32	40	40	54	60
Thread / thread depth	k	M8 x 1 / 12	M8 x 1 / 13	M12 x 1.5 / 15	M12 x 1.5 / 17	M16 / 30
	l	6	7.2	7.7	9.3	9.9
	m	2.5	3	3	3	4
	n	5	6	6	8	9
Max. / min.	o	69.5 / 55.1	86.5 / 62	112.2 / 82.4	149 / 93	193.6 / 125.6
Max. / min.	p	51.5 / 37.1	67.3 / 42.8	74.3 / 44.3	103 / 54	134.3 / 66.3
Base jaw tooth pitch	-	4.8	4.9	6	7	8.5
Master jaw offset	r	14.4	24.5	30	56	68
Master jaw offset	teeth	3	5	5	8	8
Usable jaw stroke	mm	5.9	6.2	7.4	9.6	11.4
Max. total gripping force	kN	60	75	130	180	220
At max. torque Md	Nm	80	120	160	200	250
Speed	r.p.m.	5500	4800	4200	3500	2700
Weight without jaws	kg	8.3	19	32	53	103
Moment of inertia	kg·m ²	0.03	0.09	0.25	0.60	1.9

Ordering review

Chuck with center mounting DIN 6350

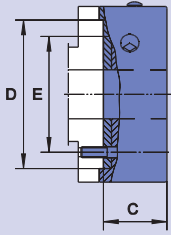

HG-F	160-46		210-60		260-81		315-102		400-128	
Mounting	Z140		Z170		Z220		Z300		Z380	
C	64		85.5		94		111		132	
D	140		170		220		300		380	
E	104.8		133.4		171.4		235		330.2	
Chuck with MFG + WAK										
Id. No.	090521		090026		090058		090090		090122	
Chuck with FST										
Id. No.	090523		090028		090060		090092		090124	
Chuck with MFG + GUA										
Id. No.	090522		090027		090059		090091		090123	

Chuck with ISO-A mounting DIN 55026

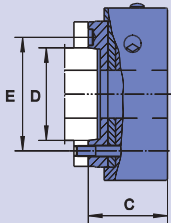

HG-F	160-46		210-60			260-81		315-102		400-128	
Mounting	A4	A5	A5	A6	A8	A6	A8	A8	A11	A11	A15
C	84	79	109.5	107.5	125.5	118	119	141	141	168	168
D	63.51	82.56	82.56	106.39	139.73	106.39	139.73	139.73	196.88	196.88	285.77
E	82.6	104.8	104.8	133.4	171.4	133.4	171.4	171.4	235.0	235.0	330.2
Chuck with MFG + WAK											
Id. No.	090524	090527	090543	090030	090034	090062	090066	090094	090098	090126	090130
Chuck with FST											
Id. No.	090526	090529	090545	090032	090036	090064	090068	090096	090100	090128	090132
Chuck with MFG + GUA											
Id. No.	090525	090528	090544	090031	090035	090063	090067	090095	090099	090127	090131

Chuck with bayonet mounting DIN 55027 Type C

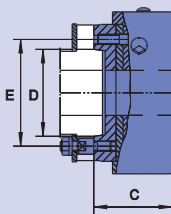

HG-F	160-46		210-60			260-81		315-102		400-128	
Mounting	C4	C5	C5	C6	C8	C6	C8	C8	C11	C11	C15
C	84	84	107.5	107.5	125.5	119	119	141	141	168	168
D	63.51	82.56	82.56	106.39	139.73	106.39	139.73	139.73	196.88	196.88	285.77
E	85	104.8	104.8	133.4	171.4	133.4	171.4	171.4	235.0	235.0	330.2
Chuck with MFG + WAK											
Id. No.	090530	090533	090546	090038	090042	090070	090074	090102	090106	090134	090138
Chuck with FST											
Id. No.	090532	090535	090548	090040	090044	090072	090076	090104	090108	090136	090140
Chuck with MFG + GUA											
Id. No.	090531	090534	090547	090039	090043	090071	090075	090103	090107	090135	090139

Chuck with camlock mounting DIN 55029 Type S

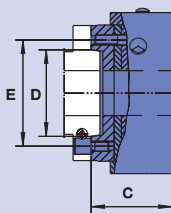

HG-F	160-46		210-60			260-81		315-102		400-128	
Mounting	S4	S5	S5	S6	S8	S6	S8	S8	S11	S11	S15
C	92	92	118.5	118.5	125.5	132	132	154	154	182	182
D	63.51	82.56	82.56	106.39	139.73	106.39	139.73	139.73	196.88	196.88	285.77
E	82.6	104.8	104.8	133.4	171.4	133.4	171.4	171.4	235.0	235.0	330.2
Chuck with MFG + WAK											
Id. No.	090536	090539	090549	090046	090050	090078	090082	090110	090114	090142	090146
Chuck with FST											
Id. No.	090538	090541	090551	090048	090052	090080	090084	090112	090116	090144	090148
Chuck with MFG + GUA											
Id. No.	090537	090540	090550	090047	090051	090079	090083	090111	090115	090143	090147

Parts included: Fixing elements (screws resp. studs resp. camlock bolts).

HG-F

QUICK JAW CHANGE
Jaw system Forkardt

Jaws

MFG

Hardened base jaws

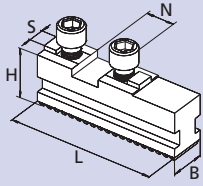

Chuck	HG-F 160	HG-F 210	HG-F 260	HG-F 315	HG-F 400
Jaw type	MFG 160	MFG 200	MFG 250	MFG 315	MFG 400
Id. No.	081303	081304	081305	081306	081307
B	20	22	26	32	45
H	29.5	35	40	46	55
L	74	90	110	125	160
N	18	20	20	26	30
S	8	10	12	12	18
kg / set	0.8	1.2	2.0	3.3	7.3

WAK

Soft top jaws

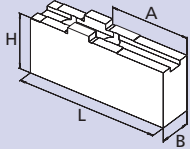

Chuck	HG-F 160	HG-F 210	HG-F 260	HG-F 315	HG-F 400
Jaw type	WAK 160-10	WAK 200-10	WAK 250-10	WAK 400-10	WAK 500-10
Id. No.	012491	012492	012493	012494	012495
B	20	22	30	35	50
H	35.5	42	50	54	73
L	85	105	125	145	180
A	42	50	70	74	100
kg / set	1.2	2.0	3.6	5.8	13.7

WAKS

Wide soft top jaws

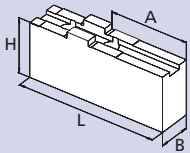

Chuck	HG-F 160	HG-F 210	HG-F 260	HG-F 315	HG-F 400
Jaw type	WAKS 140-10	WAKS 200-30	WAKS 250-20	WAKS 400-30	WAKS 500-30
Id. No.	012496	012497	012498	012500	012501
B	35	40	60	80	90
H	35.5	36	55	64	73
L	63	70	90	100	130
A	25	27	44	44	65
kg / set	1.5	1.9	6.2	11.0	16.4

BFR

Soft monoblock jaws

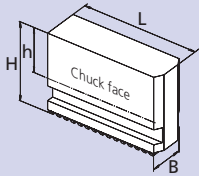

Chuck	HG-F 160	HG-F 210	HG-F 260	HG-F 315	HG-F 400
Jaw type	BFR 160	BFR 200	BFR 250	BFR 315	BFR 400
Id. No.	081272	081273	081274	081275	081276
B	20	22	26	32	45
H	45	60	70	81	93
h	24	35	40	46	45
L	79	94	115	140	176
kg / set	1.4	2.6	4.4	7.4	15.4

FST

Hardened stepped monoblock jaws

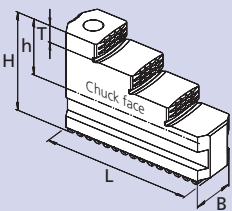

Chuck	HG-F 160	HG-F 210	HG-F 260	HG-F 315	HG-F 400
Jaw type	FST 170	FST 210	FST 250	FST 315	FST 400
Id. No.	081282	081283	081284	081285	081286
B	20	22	26	32	45
H	45	60	70	79	93
h	24	35	40	46	53
L	79	94	114	130	167
T	7.5	1.0	14	15	20
kg / set	1.1	1.9	3.3	5.2	10.8
A1	6-59	10-96	19-99	20-115	48-173
A2	42-89	56-130	76-142	85-180	116-238
A3	73-120	96-170	120-186	140-235	184-308
A4	104-151	136-210	164-230	195-290	252-378
J1	44-78	70-147	81-147	80-170	118-243
J2	74-110	109-187	125-191	135-225	186-310
J3	105-141	149-228	169-235	190-282	253-378
J4	135-182	186-260	211-278	255-350	328-448
S	198	244	280	350	456

Clamping ranges

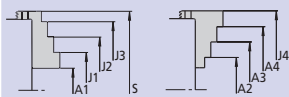

JAWS-CATALOG

Request or
download:
www.smw-autoblok.de



Jaws ■ Grease

GUA
Hardened reversible
stepped top jaws

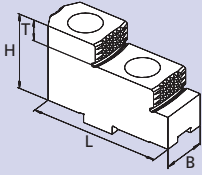

Clamping ranges

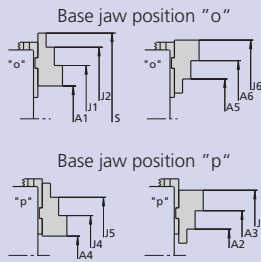

Chuck	HG-F 160	HG-F 210	HG-F 260	HG-F 315	HG-F 400
Jaw type	GUA 160	GUA 200	GUA 250	GUA 400	GUA 500
Id. No.	012484	012485	012486	012487	012488
B	20	22	30	36	45
H	36.5	38	50	56	70
L	63	72	90	105	130
T	7.5	10	14	15	20
kg / set	0.6	0.8	1.9	3.2	10.8
A1	32-69	55-111	73-161	64-194	108-264
A2	60-98	69-125	45-101	44-108	70-158
A3	85-123	96-152	125-181	156-220	171-259
A4	13-51	17-73	20-97	22-100	24-146
A5	78-116	104-163	76-165	72-202	121-277
A6	103-141	131-190	156-245	134-314	222-378
J1	91-129	117-174	152-240	140-270	223-379
J2	116-154	144-201	233-321	256-382	324-480
J3	144-181	158-215	204-259	323-296	286-374
J4	74-111	80-136	101-177	93-176	138-260
J5	99-136	107-163	180-257	210-288	239-361
J6	162-200	193-253	235-323	260-390	336-492
S	198	196-253/255	333	372	492

JAWS-CATALOG
Request or
download:
www.smw-autoblok.de



Important for maintenance and safe operation, to be ordered with the chuck

Grease K05®

Special grease for
manual and power chucks



Cartridge 14 Oz. (DIN 1284)
Grease content 500 g
Id. No. 016440

Can 1000 g
Id. No. 011881



- High adhesion
- High resistance against coolant
- High load bearing capacity
- Low friction coefficient
- High gripping force
- Avoids tribocorrosion

Grease gun

Grease gun (DIN 1283) for
cartridges 14 Oz. (DIN 1284)

■ Also refillable from grease can 1000 g



Lubrication set Id. No. 083726

Supply range

- Grease gun
- 1 Adapter flexible for high pressure grease nipple
- 1 Adapter for cone grease nipple