



Mail Manager®

Congratulations on the purchase of your Mail Boss® Mail Manager® locking security mailbox. The Mail Boss Mail Manager is designed with your security and convenience in mind. This mailbox is constructed of tough, vandal resistant, heavy gauge galvanized steel and comes with patented security features to keep your mail safe. The Mail Manager mailbox is designed with a large internal volume so that more than several days of mail can be securely stored inside. This product can be installed on a matching in ground steel post or simply attached to most pre-existing mailbox stands. If this mailbox was purchased without a post and you desire to install this mailbox on a matching steel post, you may purchase one as well as other accessories at www.mailboss.com.

On this insert you will find a list of hardware parts included as well as detailed instructions. Installation is quite simple and requires only a 13mm socket & ratchet, 13mm wrench or crescent wrench (note: If mounting onto an existing wood stand you will need a portable drill to drill four pilot holes). Installation will be most easily accomplished if you take the time to carefully sort the hardware and familiarize yourself with the function of each piece.

If you require assistance with assembly, part replacement, or any other matter, contact the toll-free Epoch Design Service Center from anywhere in the Continental United States, Monday through Friday, 9AM - 5PM Pacific Standard Time at 1-800-589-7990. You may also email your request or comments to info@mailboss.com and a service representative will respond.

You will also find helpful hints and tips on our website: www.mailboss.com.

Thank you.

Parts and Hardware List

- 4** 1 1/2" long lag screws
(13mm head)
Connect mailbox to a wooden mailbox platform



- 3** Security key
Used to lock and unlock your Mail Boss

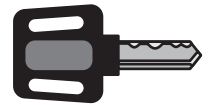

- 2** 3/4" stainless machine bolts
(#2 Phillips Head)
Attach Mail Boss to the Fast-Trak mounting plate

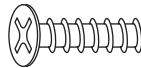

- 1** 1/4" pilot hole drill bit
For drilling pilot hole into existing wooden mailbox platform



- 1** Mail Manager mailbox
Locking security mailbox

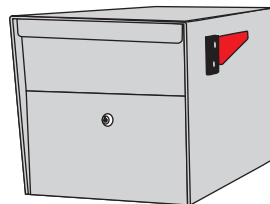

- 1** Floor liner
Used to receive mail smoothly and protect mailbox floor

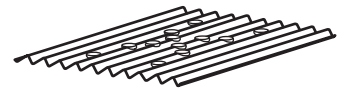

Accessory items and parts available: www.mailboss.com

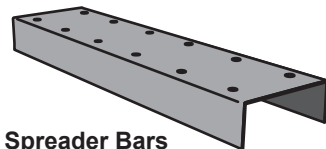

Spreader Bars
Allows Mounting Of Two, Three Or Four Mailboxes On One Post Available In All Colors

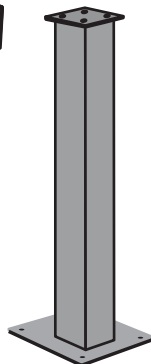

Surface Mount Post & Base Plate
Available In All Colors



In Ground Post
Available In All Colors



Flag

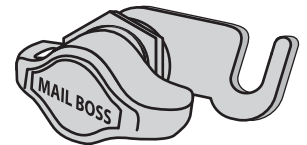

HASP Lock
Standard padlock compatible

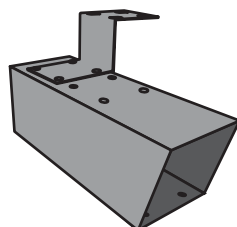

Newspaper Holder
Available In All Colors

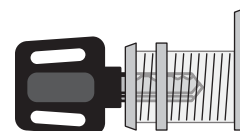

12 Disc High-Security Lock
Additional Keys and/or Lock



Lock Dust Cover
Protects lock mechanism

Have a question?... Need a part ASAP?...1-800-589-7990

Fits almost any post or platform!

It is advised to contact the local post office or mail carrier before installing the mailbox to ensure its correct placement at the street. Generally, mailboxes are installed at a height of 41" - 45" from the road surface to the point of mail entry for a locking mailbox, and are set back 6" - 8" from the front face of the curb or road edge to the mailbox door. Please note that it is not the responsibility of mail carriers to open mailboxes that are locked, accept keys for this purpose or lock mailboxes after delivery.

WOOD POST / WOOD GANG PLANK

We have provided 4 Lag screws that can be used to mount this mailbox onto wood. There are many ways to do this depending on your specific needs. You may want to look at examples in your neighborhood or on the internet to give you ideas on what is best for you.

- 1** Using a pen/pencil mark the holes you will be drilling into the wood using the bottom of the mailbox as your template.

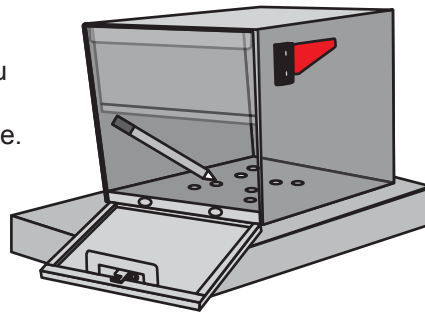

- 2** Use a 1/4" drill bit to pre-drill the holes into the wood post or gang plank.

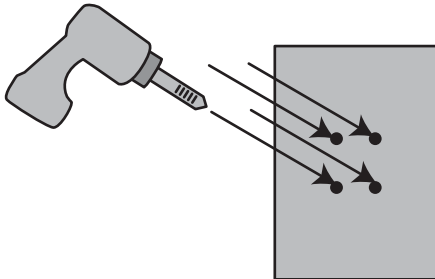

- 3** Secure the mailbox to the wooden platform using the lag bolts provided.

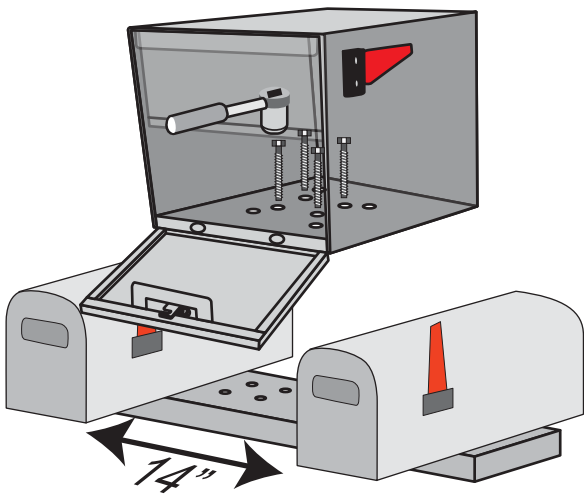

- 4** Place liner on floor inside of mailbox.



floor liner

METAL POST

- 1** Secure the mailbox to the top of the post using the machine screws provided with the post. Secure bolts with a 13mm socket or wrench.

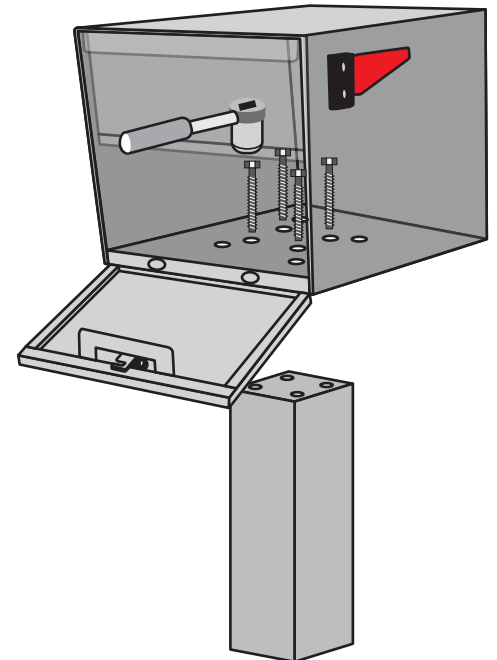

- 2** Place liner on floor inside of mailbox.

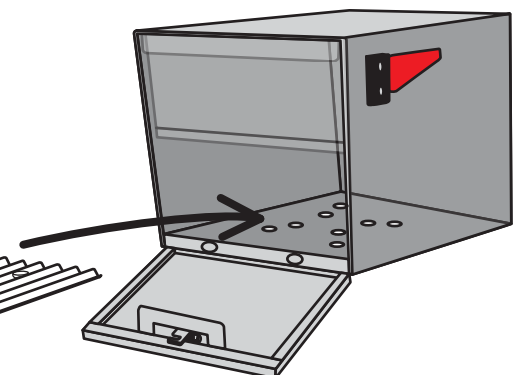

! IMPORTANT !

We strongly recommend you WRITE DOWN YOUR KEY NUMBER and keep it in a safe place.

Without a key number we will not be able to provide replacement keys, you will have to purchase a new lock and keys set. For security purposes, we reserve the right to deny key replacement without proof of purchase. Additional keys can be purchased at mailboss.com

CARE AND MAINTENANCE: Your new Mail Boss mailbox is designed to withstand the elements, to help preserve the UV and weather coating apply a clear or light colored car wax to the exterior of the box 2-3 times per year. If your mailbox finish is damaged exposing the metal, we recommend prompt application of a matching protective paint such as Rust-Oleum to prevent rusting. To preserve your lock we recommend the application of "Tri-Flow" lubricant to the interior of the lock twice a year. If you live in an area where dust, debris or salt spray is prevalent, you may consider purchasing a lock dust cover from mailboss.com for added protection.