

## Vehicle Detection Sensor for Gate

# ViiK Gate

## OVS-01GT

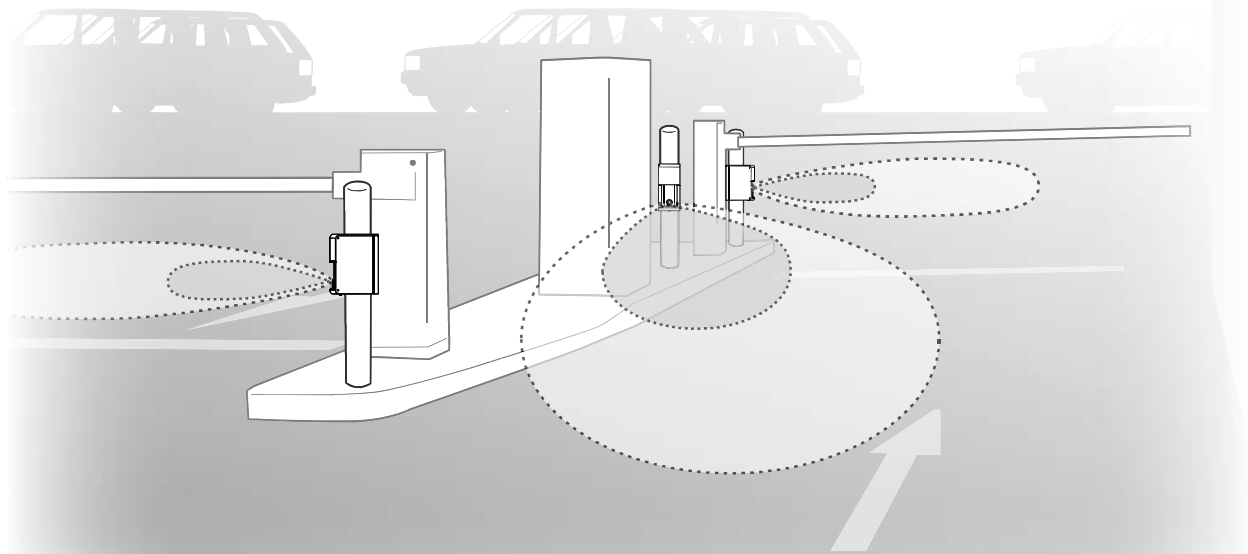

## Table of Contents

1	Safety Precautions	2
2	Component Name	3
3	Before Using the Product	4
3-1	Detection Principle and Basic Operation of the Sensor	4
3-2	Sensor Installation Recommendations	5
3-3	Sensor Detection Conditions	6
3-4	Installation Workflow	7
4	Installation Steps (Basic)	9
4-1	Installation of the Units	9
4-2	Setting Verification and Adjustment	12
4-3	Calibration	13
4-4	Detection Area Check	14
4-5	Other Functions	16
5	Advanced Installation	17
5-1	Sensitivity	17
5-2	Human Cancel Adjustment	18
5-3	Presence Detection Timer	19
5-4	Sensitivity Boost Timer	21
5-5	Ultrasonic Maximum Range	22
5-6	Input	23
6	Troubleshooting	24
7	Specifications	26
7-1	Specifications	26
7-2	Detection Area Diagram	27
7-3	Dimensions	27

## Features

- Vehicle detection is ensured by a combination of microwave and ultrasonic wave.
- A microwave sensor can detect the presence of a vehicle based on FMCW (Frequency-modulated continuous-wave).
- Detection of objects other than a vehicle can be reduced (patent pending).
- Built-in heater reduces snow on the sensor (automatically activates based on the outside air temperature).
- Not affected by underground obstructions, this product is installed above ground.
- Reduced installation time as access road for vehicle is not closed, as no civil engineering works is required..



# 1 Safety Precautions

This product is a vehicle detection sensor designed for activation and presence of a vehicle, installed close to the gate operator. Do not use the product for other purposes.



## For Safe Use

### About the Marks





The description given here is for correct usage of the product without causing damage to you, other personnel as well as damage to properties. The marks and their meanings are as follows: Please read the text after understanding the contents well.

 <b>WARNING</b>	Failure to follow the instructions provided with this indication and improper handling may cause death or serious injury.
 <b>CAUTION</b>	Failure to follow the instructions provided with this indication and improper handling may cause injury and/or property damage.





### EXAMPLES OF GRAPHICAL INDICATION

	The △ symbol indicates what you need to pay attention to (including warning). The specific warnings are indicated in the symbol (the figure to the left indicates danger of electric shock).
	The ⊘ symbol indicates prohibition. The specific warnings are indicated in or near the symbol (the figure to the left indicates prohibition of disassembly).
	The ● symbol indicates a compulsory conduct or an item to be observed. The specific instructions are indicated in or near the symbol (the figure to the left indicates that power should be turned off).

## WARNING

	Do not touch with wet hands	Do not touch the main unit or the power supply terminal with wet hands (Do not touch them when hands are wet with rain as well). Electric shock may occur.
	Do not disassemble or remodel the unit	NEVER perform disassembly or modification of the unit which is dangerous. Fire or electric shock may occur.
	Turn OFF the system power in case of abnormality	Should you use the unit under abnormal conditions if there is smoke or a smell, it may cause fire, electric shock, or burns. Immediately turn off the power and contact the contractor.
	Use the unit within the scope of its specifications	Use the unit within the scope of the specifications designated by this document. The unit will not work properly and fire or electric shock may occur.
	Always turn off the power during installation	Always turn off the unit's power on installation and/or wiring. Electric shock may occur.

## CAUTION

	Do not water the unit with high pressure water	Do not water the unit with bucket, hose, and/or high pressure washing machine. Water may get in the unit and cause damage.
	Perform wiring tightly and surely	Follow the steps described in this document for wiring. Fire or electric shock may occur.
	Fix tightly	Follow the steps described in this document when attaching the unit to a pole. The units may fall or its cable may become loose, resulting in injury, fire, and/or electric shock.
	Install and configure the units properly	Follow the steps described in this document for proper installation, configuration, and operation check. It may result in a failure of vehicle detection.
	Regularly clean the unit	Please clean the unit regularly. If you find any abnormality, do not use it.

# 2 Component Name

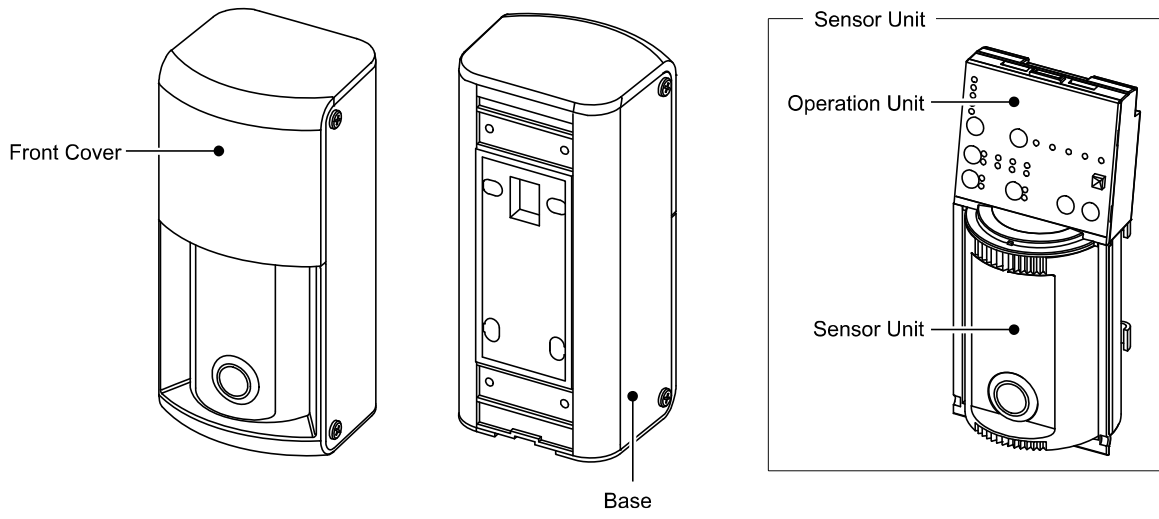

## ■ Operation Unit

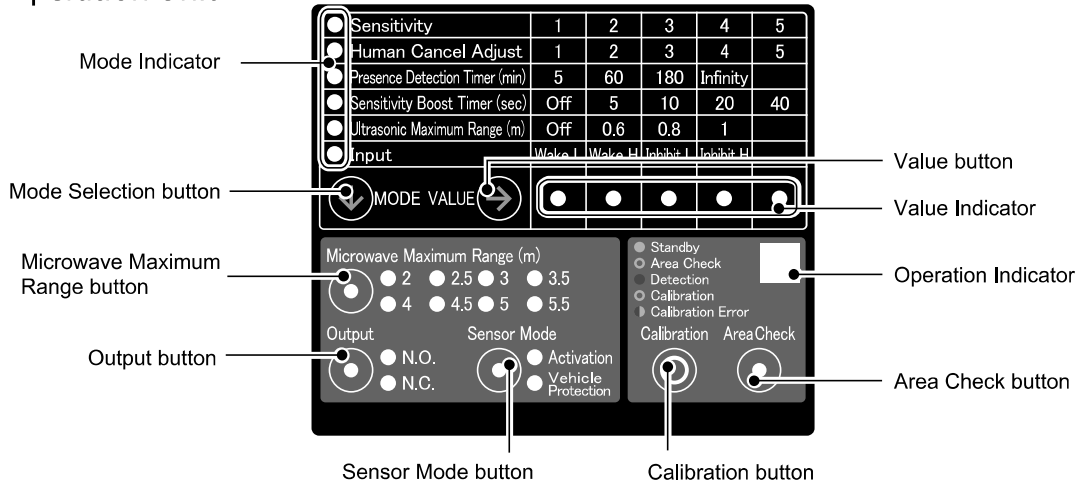

## ● Operation Indicator

Standard Operation	Standby: Solid Green, Detected: Solid Red
Detection Area Check	Non detection: Blinking Green, Microwave sensor detected: Blinking Yellow Ultrasonic sensor detected: Blinking Purple, Microwave/ultrasonic both sensor detected: Blinking Red
Calibration	Getting Ready: Slow Blinking Blue, Calibrating: Quick Blinking Blue, Ultrasonic sensor detection error: Alternate Blinking Red-Blue
Sensor Reset	Reset Complete: Solid Yellow for 2 seconds

## ■ Terminal Block

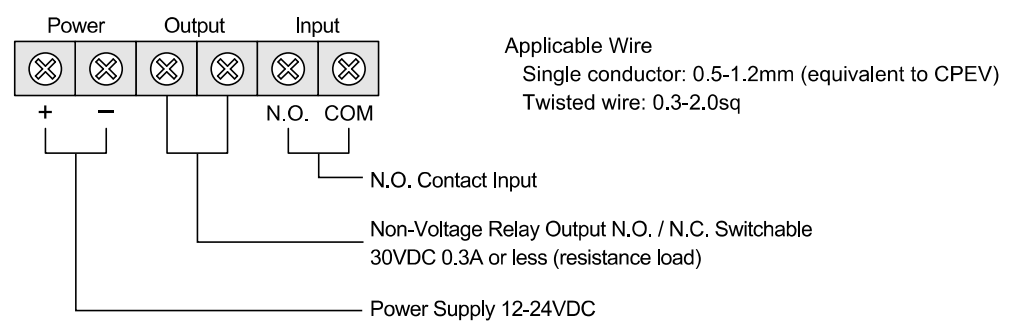

## 3 Before Using the Product

### 3-1 Detection Principle and Basic Operation of the Sensor

- Detection Principle
  - This sensor uses reflection of a microwave and ultrasonic to detect a vehicle.  
(The higher the reflection, the easier the detection becomes.)
  - The microwave sensor uses FMCW technology, it can detect the presence of a vehicle.
  - The ultrasonic sensor detects a vehicle close to the sensor.
  - The detection logic is shown below.

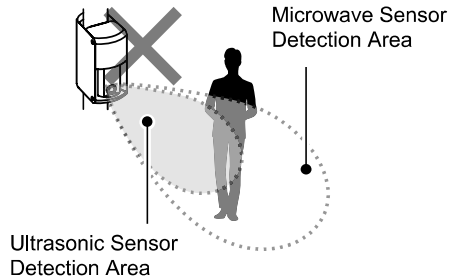

If only a person is in the detection area, the relay signal output will not trigger even if the ultrasonic sensor detects the person (except when the sensitivity level is set to 5).

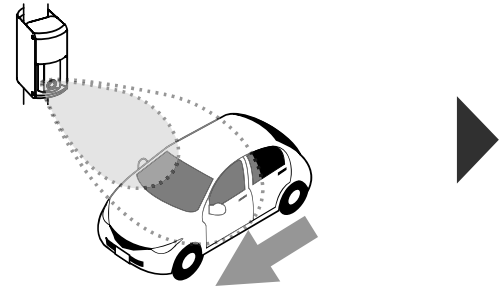

When a vehicle is present, the microwave sensor detects the vehicle and the ultrasonic sensor is activated at the same time (if the sensitivity level is configured at 5, the ultrasonic sensor will be activated all the time).

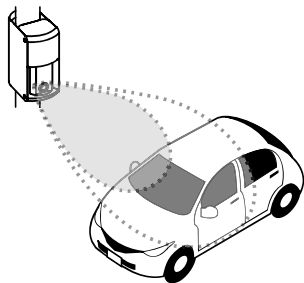

If a vehicle is parked in the detection area, the sensor will maintain the detection status.

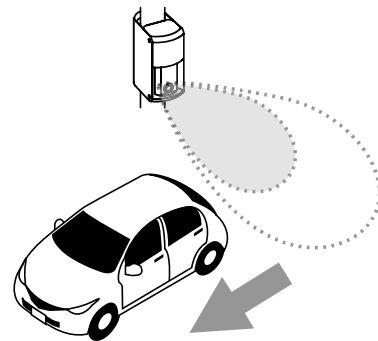

When the vehicle leaves the detection area, the sensor will change to a non-detection status. You can change non-detection timing by setting the OFF-delay timer.

#### NOTE

The following cases may occur due to the sensor detection principles.

- If a person or an object is in the detection area after the Vehicle leaves, the sensor will maintain the detection status even if the vehicle leaves the detection area.  
The sensor may not change to (or less tend to become) non-detection status due to a flag/banner, tall weeds, and/or snow.
- If one vehicle tailgates another vehicle very closely when entering the detection area, they may be regarded as one vehicle.

## 3-2 Sensor Installation Recommendations

There are two (2) types of sensor installations. Choose one depending on the site conditions from the following. The sensor will not work correctly unless the installation directions, height, and operation type are correct.

### • Barrier Gate

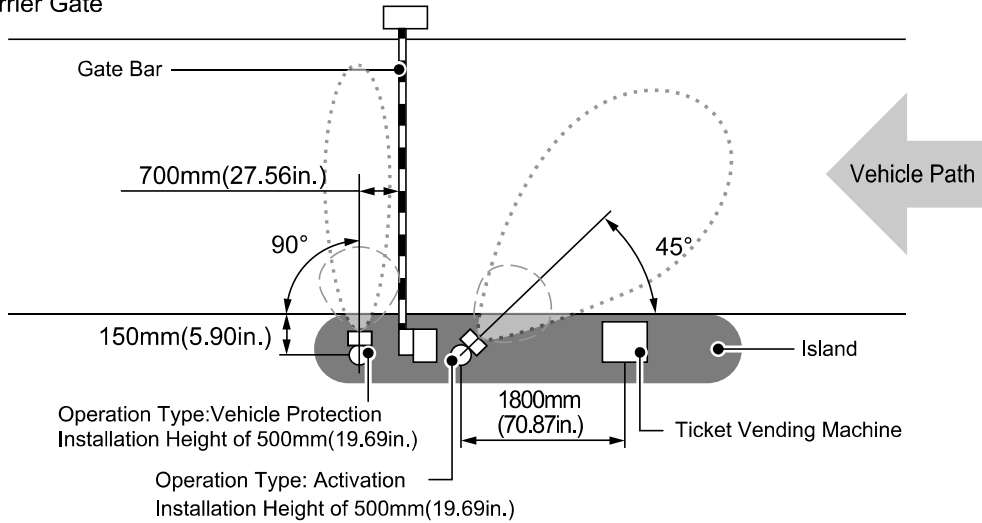

### • Slide Gate

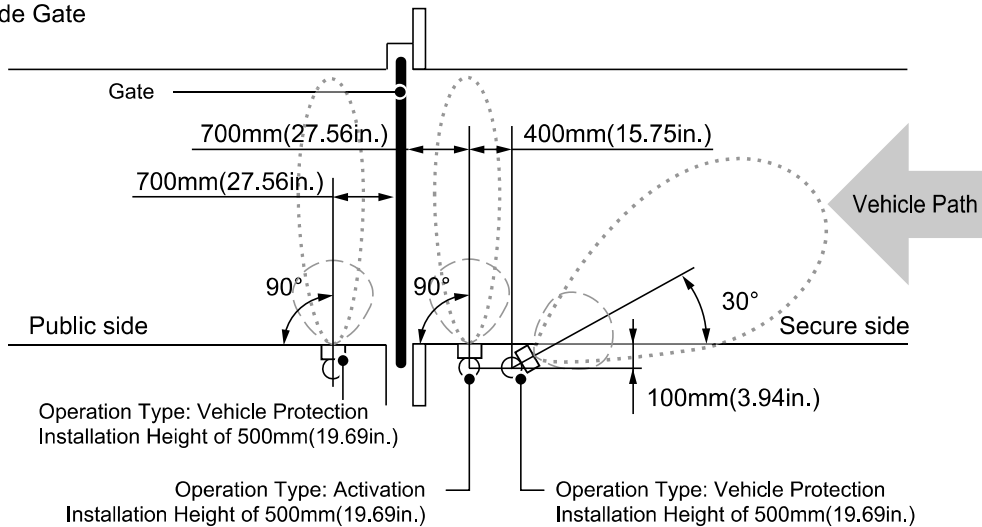

### NOTE

- Always install the sensor on the vertical pole that is mounted in or on the ground. Installing a sensor on a tilted pole will result in a detection of the ground by the ultrasonic sensor and correct operation is not ensured.

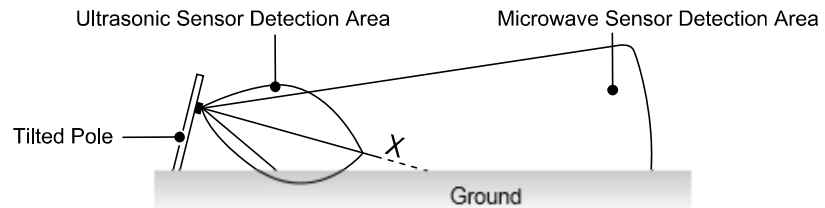

- If the pole is installed on a slope, install the sensor higher or lower in order to adjust the height of the set detection range to 500mm (19.69in.) from the ground. It may reduce the detection capability compared to the normal installation.

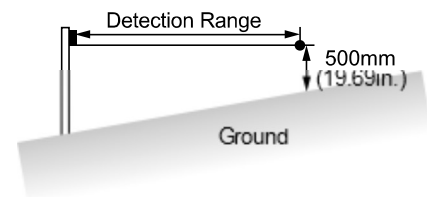

## NOTE

- Do not install any moving object such as flags or banners in the sensor's detection area. Remove any vegetation from the detection area, or reconfigure the detection area to be smaller. Not following these steps may stop the sensor reverting back to non-detection status or delay the change of status.
- Do not place an object such as a signboard close to the ultrasonic sensor's detection area. Sometimes the sensor may not become non-detection status or it may take a long time to become non-detection status after vehicle leaves.
- There should not be irregularity on the ground in the ultrasonic sensor's detection area. Sometimes the sensor may not become non-detection status or it may take a long time to become non-detection status after vehicle leaves.
- Do not use a fluorescent lamp around the detection area. It may prevent proper operation of the sensor.
- A gate bar with a curtain may cause unstable detection of the sensor. In such a case, detach or relocate the curtain where it does not affect the detection.

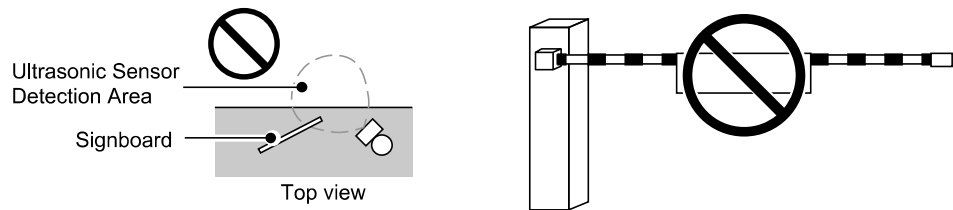

## 3-3 Sensor Detection Recommendations

- Shown below are vehicle conditions to be detected by the sensor.  
Minimum ground clearance: 150mm(5.91in.) or more
- A vehicle is detected when it approaches the gate with speed of 2 to 20 kph(1.24 to 12.43mph).

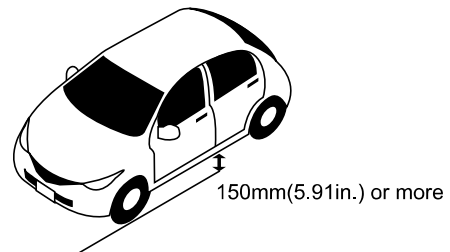

## NOTE

The following cases may occur due to the sensor's characteristics.

- The sensor may not work properly if it is installed in a location that does not meet the installation conditions.
- The sensor may not work correctly if it is not installed as per the instructions in this manual.
- Pedestrians, bicycles, or any large object entering the detection area may be detected.
- Depending on the position and/or direction of vehicle approach, the distance to be detected may become shorter or may not be detected.
- Performance of the sensor may be affected if :
  - The sensor pole is not vertical from the ground
  - The sensor surface is covered with ice, snow, or dirt.
  - A sensor unit is frozen
  - Heavy snowing conditions
  - It is raining heavily
  - Water splash is on a sensor
  - An object generating ultrasonic wave such as vehicle horn, motorcycle's engine sound, and air brake sound is approaching

## 3-4 Installation Workflow

Shown below is the sensor installation workflow. Please read carefully before installation.

### [1] Checking Installation Location: Go to P.5

Verify that the installation location meets the installation conditions.

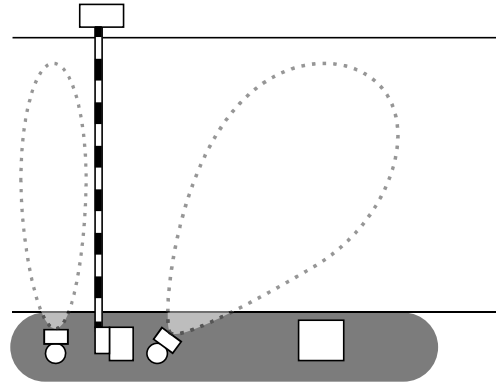

### [2] Unit Installation: Go to P.9

Remove the front cover and sensor unit, and attach the sensor and connect the wire.

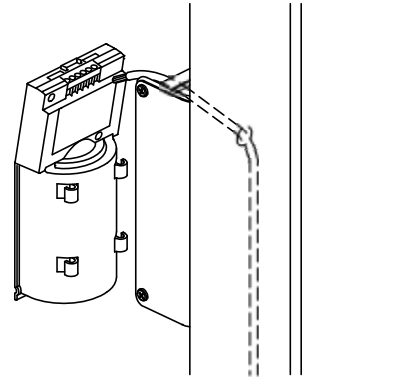

### [3] Setting Verification and Modification (if needed): Go to P.12

Check the settings, and if necessary, change them based on the installation environment and applications.

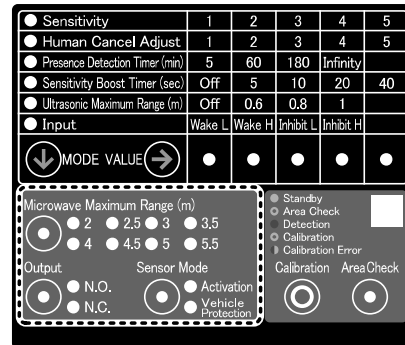

### [4] Calibration: Go to P.13

Pressing the button automatically adjusts the sensor to the installation environment.

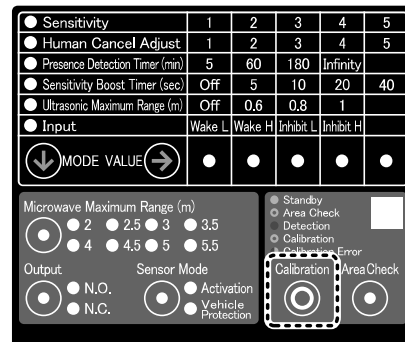

[5] Detection Area Check: Go to P.14

Verify the detection area. If needed, change the installation angle of the unit and/or sensing distance setting.

\* Once the installation condition such as the angle is modified, perform the calibration again.

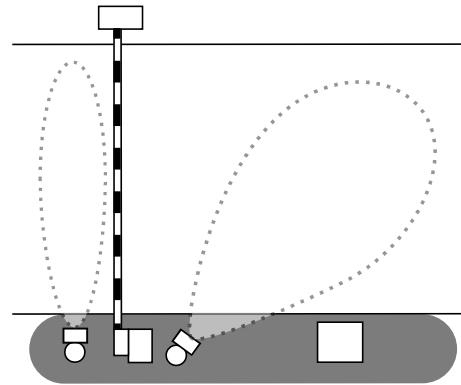
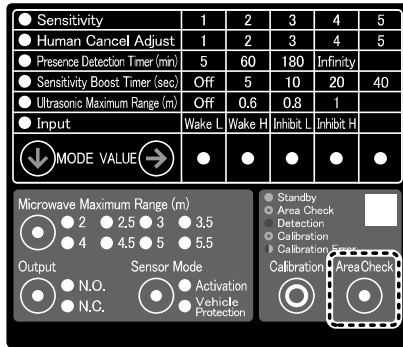

[6] System Operation Check: Go to P.15

Check the whole system operation that is connected to the sensor.

[7] Detailed Setting adjustment (if needed): Go to P.17

Change the parameter of settings if necessary after the system operation check.

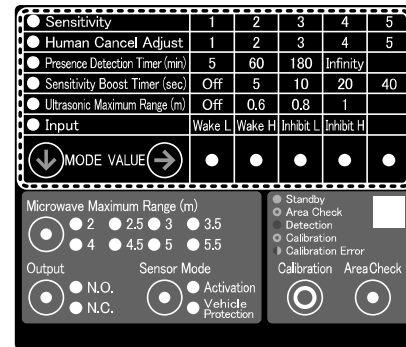

[8] Attaching Front Cover: Go to P.11

Attach the front cover, and the installation is complete.

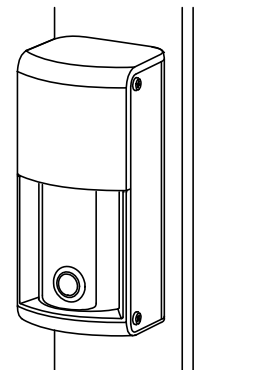

**NOTE**

**Maintenance Cleaning**

If the unit becomes dirty, lightly wipe sensor with a soft brush or cloth.  
 If not cleaned yet, use a neutral detergent to clean the sensor.

- Do not use chemicals such as alcohol.
- Do not apply high-pressure water. It may result in a failure or fire.



# 4 Installation Steps (Basic)

## 4-1 Installation of the Unit

### ■ Required Tools ■

● Precision screwdriver, Phillips #1

● Screwdriver, Phillips #2

[1] Drill pilot holes into the poles and attach the sensor.

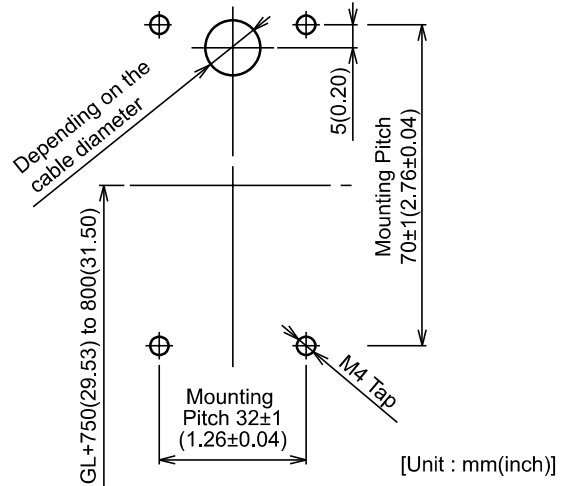

[2] Run the wire through the poles.

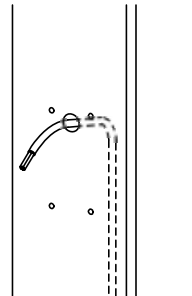

[3] Fix the poles so that the each sensor faces the angle shown below.

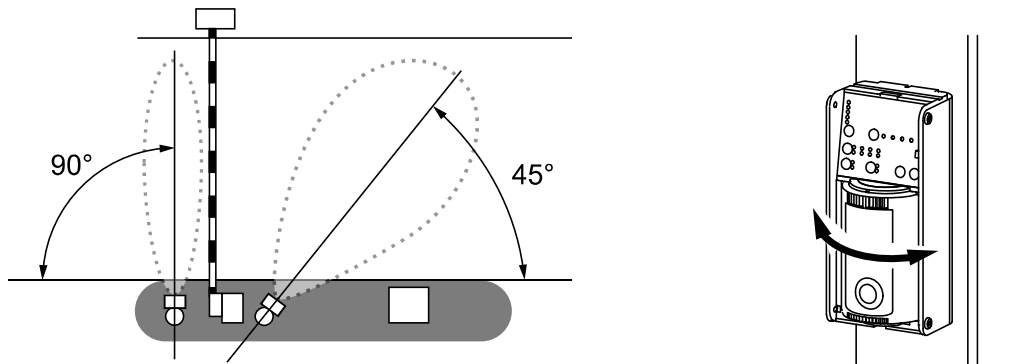

For fine angle adjustment after fixing to the poles, rotate the sensor unit to the correct angle. The sensor angle is adjustable up to 30 degrees to the left and right by 5 degree increments.

[4] Loosen the retaining screws on the bottom of the front cover and remove the front cover.

\* Do not loosen the screw completely. The screw may fall out.

If losing the screw, use a M3 x 10 philips screw.

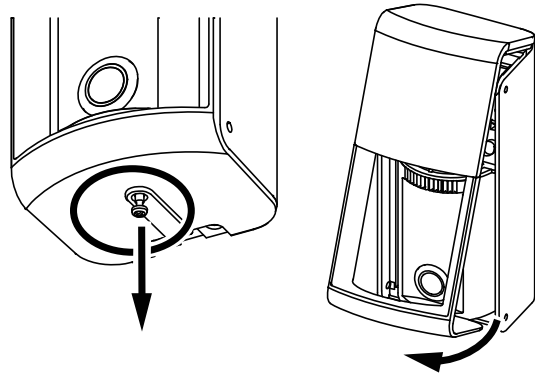

[5] Detach the sensor unit.

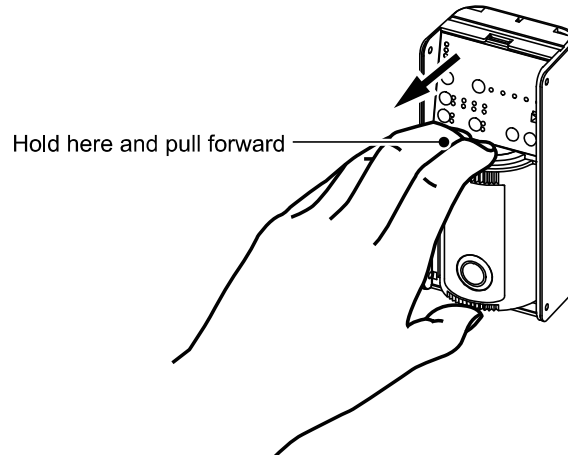

[6] Fix the base to the pole.

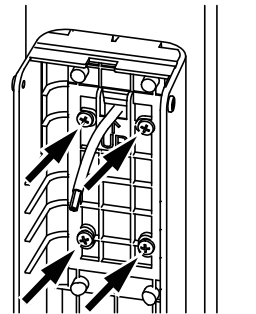

[7] Connect wires to the terminal.

Attach the relay output wire to "Output" terminal.

Attach the wakeup / inhibit wire to "Input" terminal.

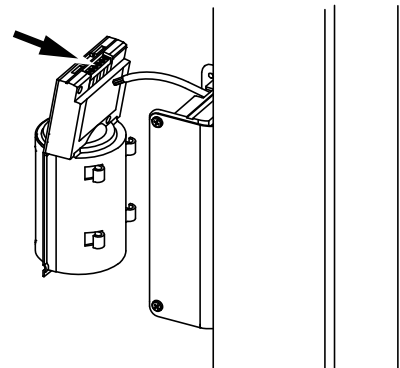
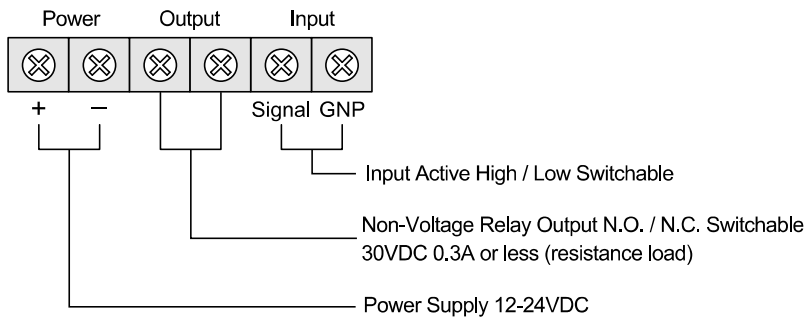

Applicable Wire

Single conductor: 0.5-1.2mm (equivalent to CPEV)

Stranded wire: 0.3-2.0sq

[8] Attach the sensor unit to the base.

Press the excess wire back into to the pole while attaching the unit.

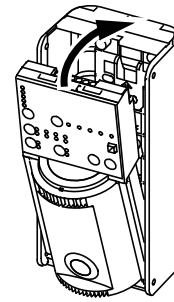

[9] Perform the steps in P.12 through 15 "4-2 Setting Verification and Adjustment", "4-3 Calibration", and "4-4 Detection Area Check".

[10] Put the front cover on the top of the base first, and attach it while spreading it open and pushing down the front cover.

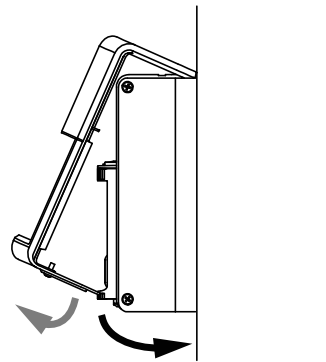
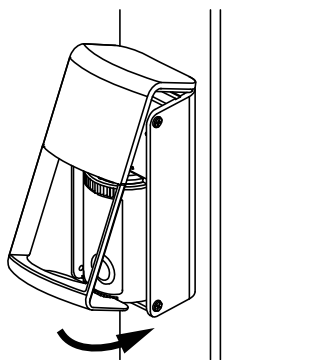

Attach the front cover while spreading it open and pushing down the bottom of the cover.

[11] Tighten the front cover retaining screw.

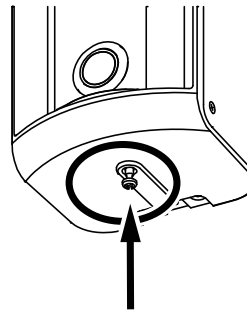

## 4-2 Setting Verification and Adjustment

● Sensitivity	1	2	3	4	5
● Human Cancel Adjust	1	2	3	4	5
● Presence Detection Timer (min)	5	60	180	Infinity	
● Sensitivity Boost Timer (sec)	Off	5	10	20	40
● Ultrasonic Maximum Range (m)	Off	0.6	0.8	1	
● Input	Wake L	Wake H	Inhibit L	Inhibit H	
MODE VALUE	●	●	●	●	●

Microwave Maximum Range (m)	● 2	● 2.5	● 3	● 3.5	● 4	● 4.5	● 5	● 5.5
Output	● N.O.	● N.C.						
Sensor Mode	● Activation	● Vehicle Protection						

This section describes how to verify the basic settings. Use the buttons to change the settings if needed.

Basic Setting Items

### [1] Output

It is possible to select the output terminal type from N.O. (make contact) and N.C. (break contact). Pressing the Output button switches between [N.O.] and [N.C.].

Factory default setting:  
N.O.

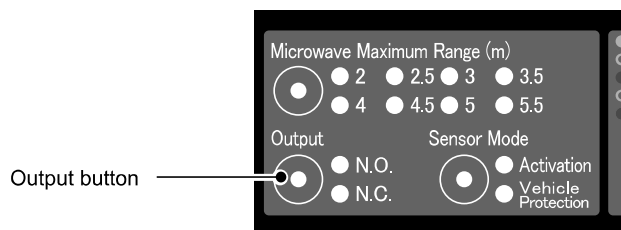

### [2] Sensor Mode

Refer to P.5 "3-2 Sensor Installation Conditions" to configure the proper sensor mode. Pressing and holding the Sensor Mode button for 2 seconds switches between [Activation] and [Vehicle Protection].

Factory default setting:  
Vehicle Protection

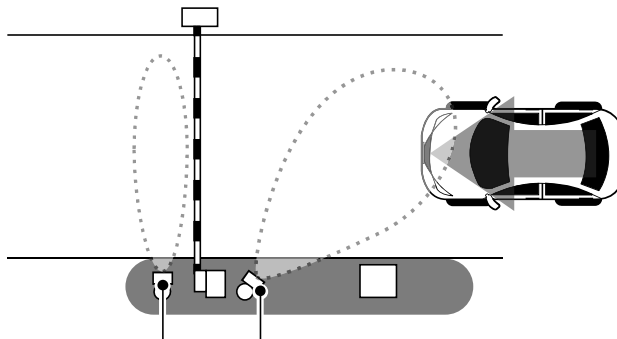

Sensor mode : Vehicle Protection    Sensor mode : Activation

### [3] Microwave Maximum Range

It is possible to adjust the detection range based on the lane width and position to detect. Pressing the Microwave Maximum Range button switches between range settings.

Factory default setting:  
3.5m(11.48ft.)

## NOTE

Recommended to set the range 500mm(1.64ft.) shorter than the actual width of the road.

Microwave Maximum Range button

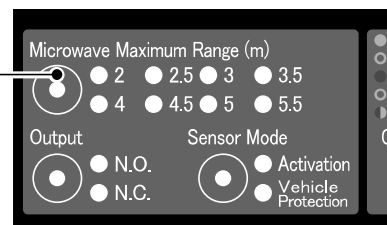

## 4-3 Calibration

### • Calibration function

This function records (memorizes) the background of the detection area without any pedestrians or vehicle present.

This process makes the sensor detection capability higher and provides stable detection.

If some noticeable change occurred around the detection area (such as construction of a wall or fence), you must perform the calibration again.

### NOTE

For normal sensor operation, the calibration must be properly performed.

The following instructions must be observed.

- Perform this after every sensor installation.
- It must be performed without vehicle, pedestrians or any other moving objects in the detection area.
- If a vehicle or pedestrian enters the detection area during the calibration, perform the calibration again.
- If changes are made to the sensor installation height, direction, and/or Microwave Maximum Range after the calibration, the calibration has to be performed again.

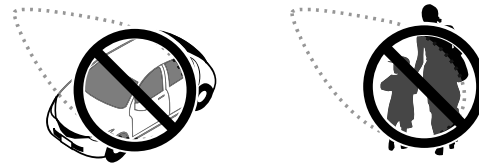

### • How to Perform Calibration

[1] Verify that within the detection area there is no vehicle, pedestrian, or objects. If anything is present remove them out of the detection area.

[2] Press and hold the Calibration button on the sensor unit for 2 seconds and verify that the operation indicator is blinking blue slowly.

The operation indicator blinks for 10 seconds and blinks more quickly for 2 seconds.

The first 10 seconds are preparation of calibration. You must keep the detection area vacant during this period.

The calibration is performed during the 2 seconds quick blinking period.

If a vehicle or pedestrian enter the detection area during calibration, perform the calibration again.

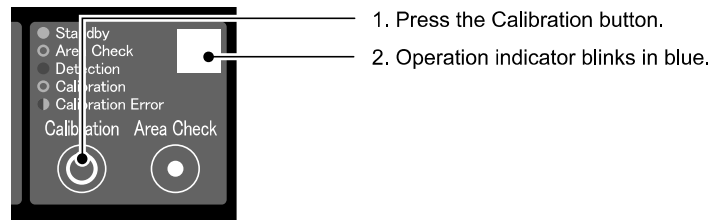

If the ultrasonic sensor detects an object during calibration, the operation indicator blinks in red and blue alternately, resulting in calibration error.

The error may be caused by the following. Remove the cause of the error and perform the calibration again. If the problem is unsolved, refer to P.22 "Ultrasonic Maximum Range" to reduce the range.

- The ultrasonic sensor detects any pedestrian or moving object (e.g. sign, gate, and gate bar) around the detection area or irregularity on the ground.
- The sensor is installed too low and detects the ground.
- The sensor pole is tilted and the sensor detects the ground.
- The sensor installation angle is not proper and the sensor detects a next vehicle or wall (fence).
- It may take more than 2 seconds for the calibration if the sensor detects a moving object.
- If the calibration does not complete, check if there is any pedestrian or moving object (e.g. flag, banner, tall weed) around the detection area. Remove it, and calibrate again.

[3] When the calibration is complete, the operation indicator turns to a solid green.

### • Cancelling Calibration

To cancel calibration, press and hold the Calibration button for 2 seconds again while the operation indicator is slowly blinking for 10 seconds. (The operation indicator turns to a solid green)

It is not possible to cancel it while the indicator is blinking quickly. Perform the calibration again.

## 4-4 Detection Area Check

- Detection Area Check Function

This function allows you to visually check the detection area of the microwave and ultrasonic signal using the operation indicator. It is possible to verify the correct angle and size of the detection area.

\*This detection area check must be performed after calibration.

- How to Check Detection Area

[1] Pressing the Area Check button switches to the Detection Area Check Mode and the operation indicator blinks green. (If you leave the unit in this mode for 30 seconds, it will automatically change back to the Normal Operation Mode)

If there is a pedestrian or an object in the detection area, the operation indicator turns either yellow, purple, or blinks red (the operation indicator color depends on the detection status of the microwave and ultrasonic sensors).

If the indicator is not blinking green, move the object out of the area until the indicator blinks green.

If the operation indicator is showing a yellow blink while there is no human or object in the detection area, perform the calibration again.

If the operation indicator is blinking purple or red, refer to P.22 "5-4 Ultrasonic Maximum Range" to reduce the range of the ultrasonic sensor.

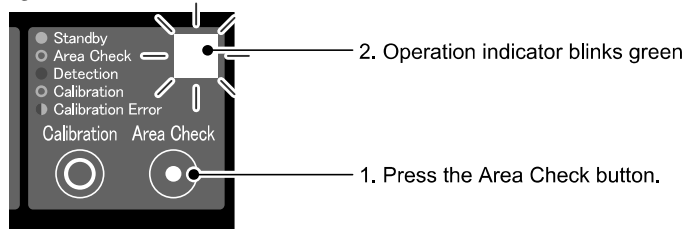

If there is a pedestrian or an object in the detection area, the indicator blinking color varies depending on the sensors' detection status.

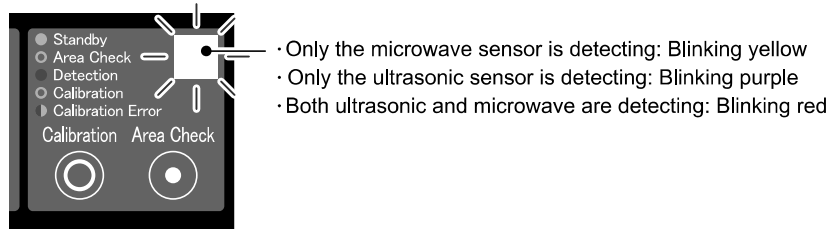

[2] Stand at the center of the vehicle lane (see Figure [A]) and walk in the direction of vehicle access.

When the operation indicator turns from green blinking (non-detection) to red blinking (detecting), it is the edge of the detection area. (Under the normal operation mode, the detection area by vehicle may be smaller)

If the detection area is not as expected, adjust the sensor angle and/or range again.

\*After the adjustment, perform calibration again.

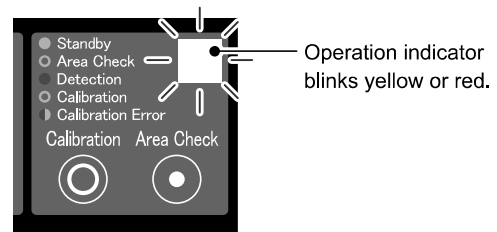
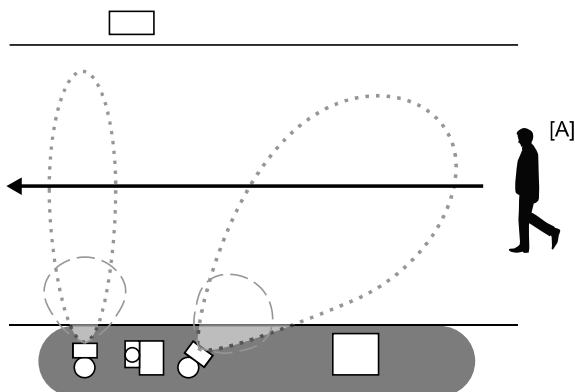

\*OFF-delay setting is not reflected under the Detection Area Check Mode.

[3] Stand at the edge of the vehicle lane (see Figure [B]), walk along the border and verify that the operation indicator keeps blinking green (not detecting).

If the operation indicator changes to yellow or Red, adjust the sensor angle and/or range setting again. After the adjustment, perform calibration again and start from [2].

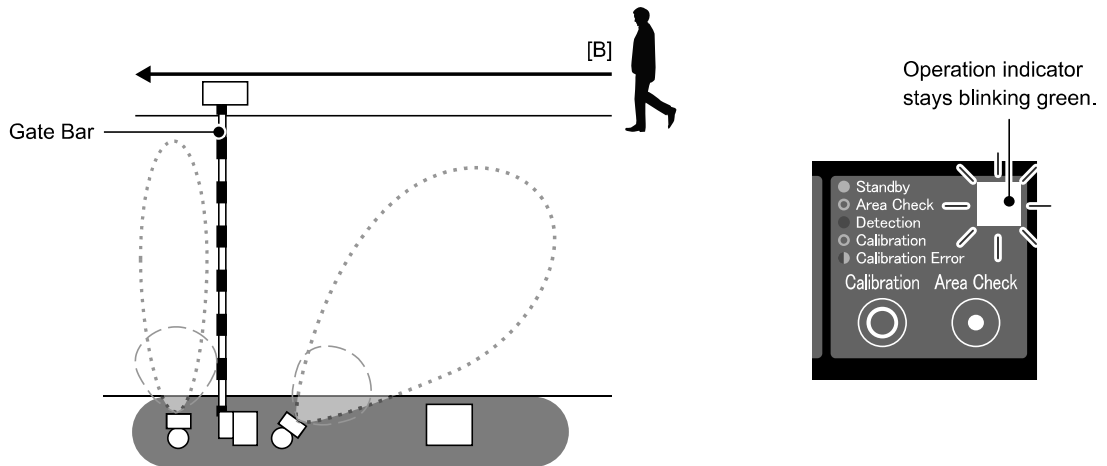

[4] After verifying the detection area, press the Area Check button again.

It switches the mode back to Normal Operation Mode and the operation indicator turns a solid green.

\*If leaving the unit in this mode for 30 seconds, it will automatically change back to the Normal Operation Mode.

## NOTE

Reducing the range of ultrasonic sensor reduces and hinders its original sensing performance. If there is a problem object around the detection area, it should be removed.

## System Operation Check

After verifying the detection area, check the entire operation system using a vehicle.

For the operation check, verify the proper operation with a vehicle on the left side, center, and right side of the lane.

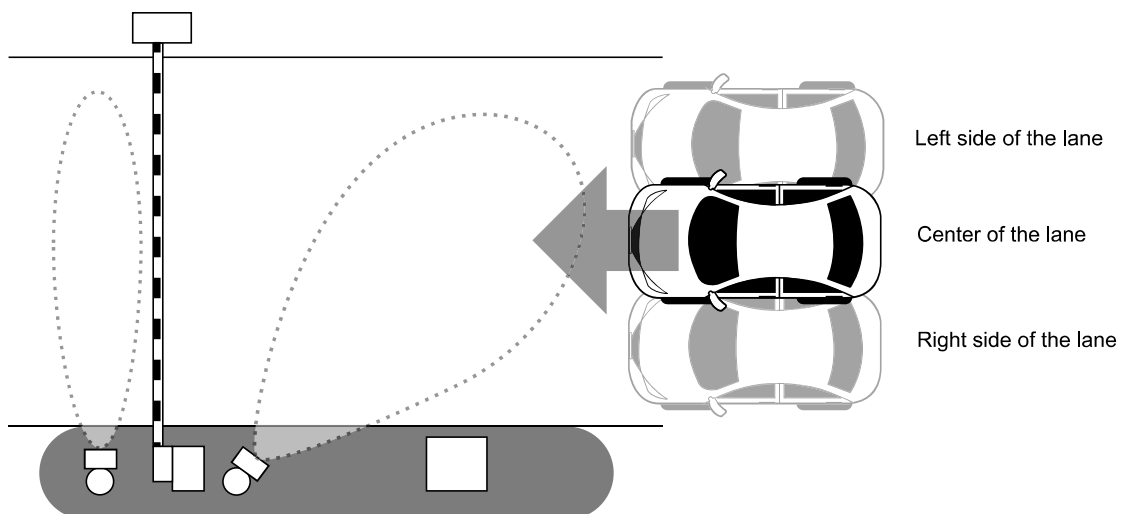

## 4-5 Other Functions

- Automatic Indicator OFF

If a button is not pressed for 30 minutes, the operation indicator dims and other indicators turn off. Pressing any button turns the indicators back on.

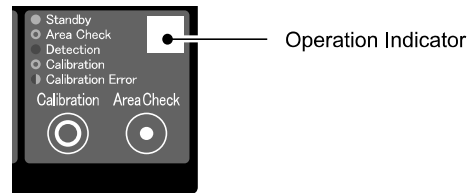

- Heater

To avoid frost and snow, the sensor unit has a built-in heater.

The heater is automatically activated when the external temperature drops below 5°C (41F) or less. (The heater is automatically deactivated when the external temperature reaches 5°C (41F) or higher)

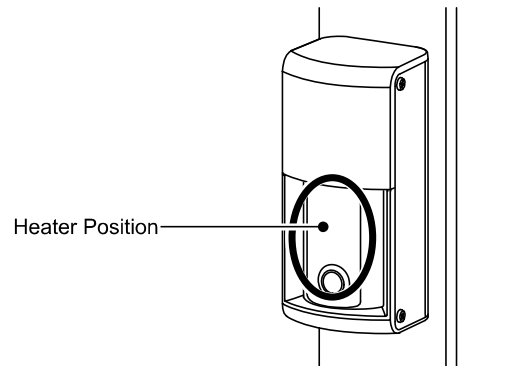

- Unsuitable environmental notification

In rare cases presence of a large metal object (i.e. a shutter) in the front of the sensor, the microwave performance may be affected and the sensor operation may become unstable.

In this particular instance, the operation indicator will be blinking green to inform you of an unsuitable environment.

When the indicator blinks in green, check if there is a large metal object in front of the sensor, and replace it as far as possible from the sensor.

\* Even if the indicator light blinks green, it does not always make the operation unstable.

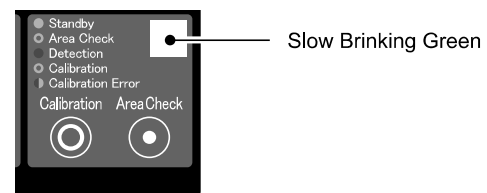

- Sensor Reset

It is possible to reset all of the settings including calibration to the factory setting. If the sensor is relocated, reset it.

To reset the sensor, press and hold both the Calibration and Area Check buttons at the same time for 2 seconds. When the reset process is completed, the operation indicator turns a solid yellow for 2 seconds.

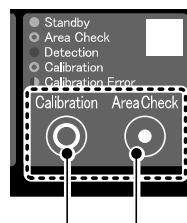

Press and hold both the Calibration button and Area Check button at the same time for 2 seconds.



# 5 Advanced Installation

The following setting parameters are to be configured if the sensor does not operate as expected in the system operation check or some error occurred. They are not necessary for a normal installation.

## 5-1 Sensitivity

Sensitivity setting and vehicle detection capability have the following relationship. In normal cases, use with the sensitivity level of 3.

Factory default setting:  
3

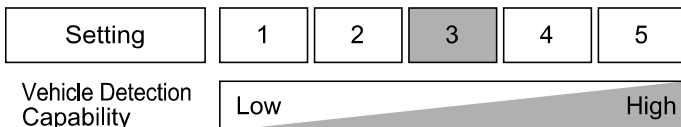

● Sensitivity	1	2	3	4	5
● Human Cancel Adjust	1	2	3	4	5
● Presence Detection Time (min)	5	60	180	Infinity	
● Anti Bump Timer (sec)	Off	5	10	20	40
● Ultrasonic Maximum Range (m)	Off	0.6	0.8	1	
● Input	Wakeup	Inhibit			
MODE VALUE	●	●	●	●	●

Setting change may be needed if:

- Increase..... Sometimes a vehicle is not detected  
Detection response is too slow
- Decrease..... Reverting back to non-detection status will take more time.

### ● How to Change Sensitivity Setting

[1] Press the Mode Select button and select [Sensitivity] the mode indicator (red).

Every time pressing the button, the mode indicator moves down by one.

[2] Press the Value button and select the desired sensitivity of the setting indicator (green).

Every time pressing the button, the sensitivity setting switches from 1 to 2, 3, 4, 5, then returns to 1, 2, and so on. The number of the setting indicator is equal to the selected sensitivity level (e.g.: If the sensitivity is 3, three indicators are turned ON).

1. Press the Mode Select button and select [Sensitivity].

2. Press the Value button to select the sensitivity.

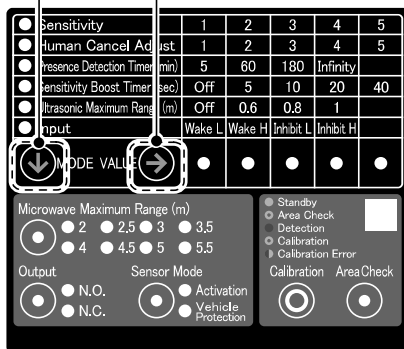

## 5-2 Human Cancel Adjustment

The human cancellation setting and human cancellation capability have the following relationship. In normal cases, use with the level of 3.

Factory default setting:  
3

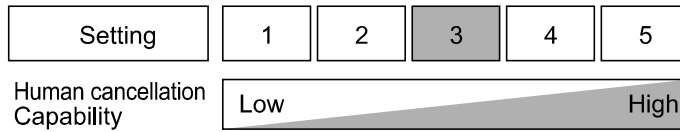

	1	2	3	4	5
● Human Cancel Adjust	1	2	3	4	5
● Presence Detection Timer (min)	5	60	180	Infinity	
● Sensitivity Boost Timer (sec)	Off	5	10	20	40
● Ultrasonic Maximum Range (m)	Off	0.6	0.8	1	
● Input	Wake L	Wake H	Inhibit L	Inhibit H	

MODE VALUE

Setting change you may need:

- Increase the value if: A human is detected sometimes  
The sensor detects a vehicle passing close to (but not in) the detection area
- Decrease the value if: A vehicle is not detected sometimes  
Response of detection is too slow

### ● How to Change the Human Cancellation Setting

[1] Press the Mode Select button and select [Human Cancel Adjust] the mode indicator (red).

Every time pressing the button, the mode indicator moves down by one.

[2] Press the Value button and select the desired sensitivity of the setting indicator (green).

Every time pressing the button, the sensitivity setting switches from 1 to 2, 3, 4, 5, then returns to 1, 2, and so on. The number of the setting indicator is equal to the selected sensitivity level (e.g.: If the sensitivity is 3, three indicators turn ON).

1. Press the Mode Select button and select [Human Cancel Adjust].
2. Press the Value button to select the sensitivity.

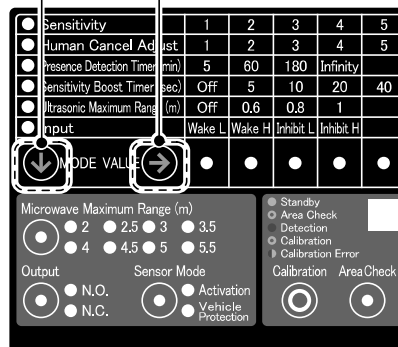

## 5-3 Presence Detection Timer

The presence detection timer periodically performs automatic calibration. It can prevent the sensor from detecting an object for a long period of time. If there is any of the following problems, configure the presence detection timer.

- The sensor keeps detecting due to an object in the detection area.
- The sensor keeps detecting after installing a roadblock.

Factory default setting:  
5min

●Operation transition of Presence Detection Timer and sensor (in case a sign is placed in the detection area)

[1] A sign is placed in the detection area of the microwave sensor and it detects the sign.

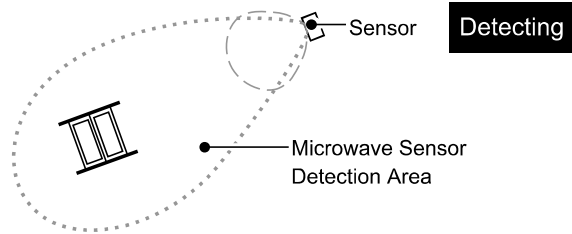

[2] When the time period of the presence detection timer runs out, the sensor no-detection because the sign is memorized as a background.

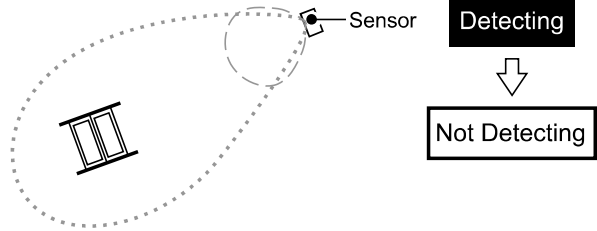

[3] When the sign is removed, the sensor may stay in a non detection, or detection state. If the sensor stays in the non detection state, it may have less sensitivity for a while.

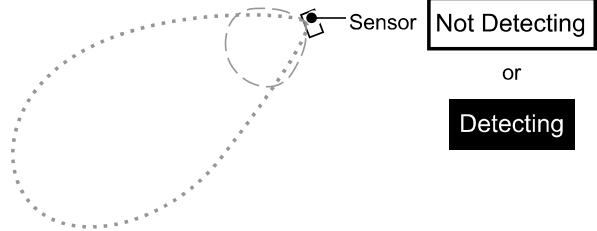

[4] If the sensor detects in [3], and when the time period of the presence detection ends, It will be memorized again as a background and be in no-detection status.

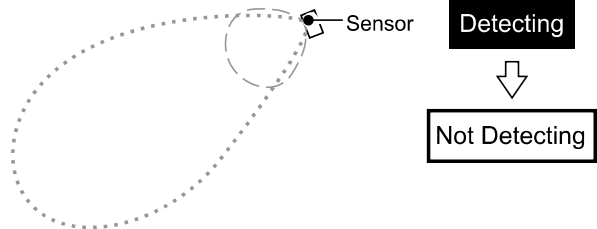

### NOTE

- If the sensor detects a moving object while the timer is active, the calibration will not be performed and the timer period will be extended.
- There is no Presence Detection Timer for the ultrasonic detection area.

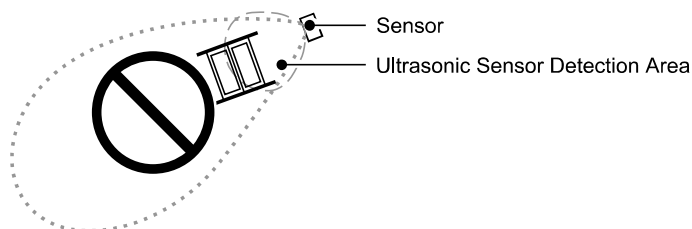

- How to Change the Presence Detection Timer

[1] Press the Mode Select button and select [Presence Detection Timer] the mode indicator (red). Every time pressing the button, the mode indicator moves down by one.

[2] Press the Value button and select the desired time period of the setting indicator (green). Every time pressing the button, the time period setting switches from 5 min to 60, 180, infinity, then returns back to 5 min.

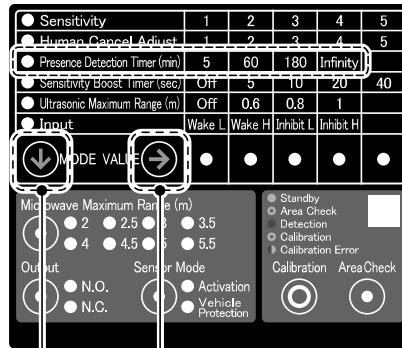

2. Press the Value button to select the presence detection timer

1. Press the Mode Select button and select [Presence Detection Timer].

## 5-4 Sensitivity Boost Timer

\* Use only if the Sensor Mode is configured as [Vehicle Protection]

The Sensitivity Boost Timer enhances the sensitivity for a certain period of time after a vehicle has passed through the detection area. Enable this function if a vehicle may back up unintentionally due to a slope in the exit area.

Factory default setting:  
Off

\* While the Sensitivity Boost Timer is enabled, a human or an object other than a vehicle can be detected.

\* The function cannot be used for a gate system without the reopen function.

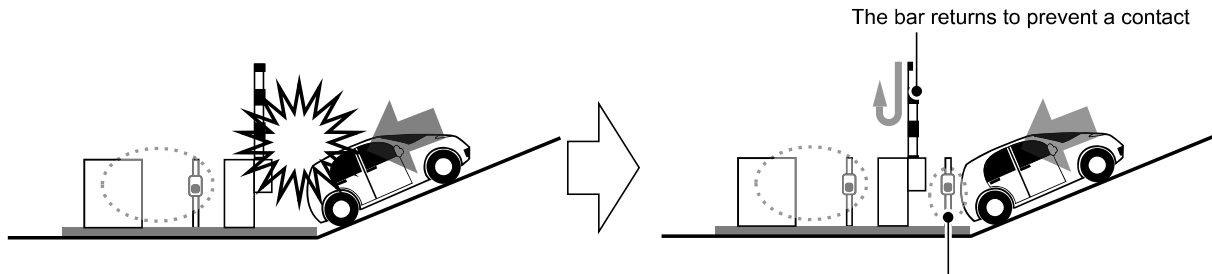

Increase the sensitivity for a certain period of time after the sensor does not detect. This will make detection of the backward rolling vehicle easier for the sensor.

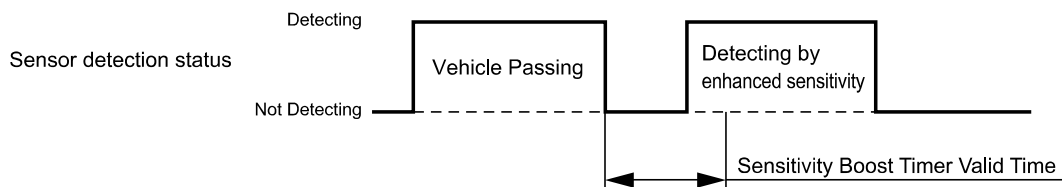

### • How to Change Sensitivity Boost Timer

If there is a traffic jam at the exit of the parking lot, increase the time period.

[1] Press the Mode Selection button and select [Sensitivity Boost Timer] the mode indicator (red).

[2] Press the Value button and select the desired time period of the setting indicator (green).

Every time pressing the button, the time period setting switches from 5 seconds to 10, 20, 40, OFF.

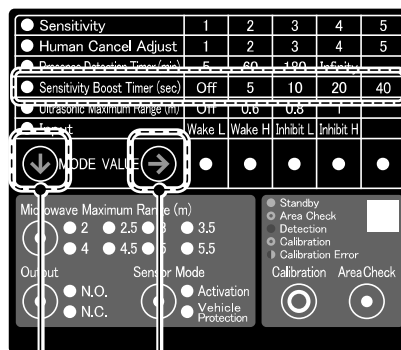

2. Press the Value button to select the time period.

1. Press the Mode Select button and select [Sensitivity Boost Timer].

## 5-5 Ultrasonic Maximum Range

If an error occurs due to an object that cannot be relocated such as the gate, avoid the error by reducing the range of the ultrasonic sensor.

Factory default setting:  
1m(3.28ft.)

- How to adjust the Ultrasonic Sensor range.

[1] Press the Mode Select button and select [Ultrasonic Maximum Range] the mode indicator (red).

[2] Press the Value button and select the desired sensing distance of the setting indicator (green).

Every time pressing the button, the sensing distance switches from 0.6m to 0.8, 1, OFF and returns back to 0.6.

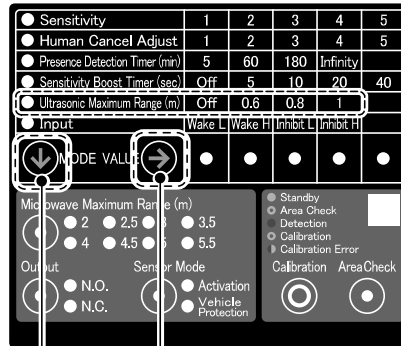

2. Press the Value button to select the sensing distance.

1. Press the Mode Select button and select [Ultrasonic Maximum Range].

### NOTE

·Reducing the range of the ultrasonic sensor reduces and hinders its original sensing performance. If a problem object is around the detection area please remove it.

## 5-6 Input

- Wake up

When using the input for vehicle protection, it is possible to use an external input to trigger a sensitivity enhancement.

Factory default setting:  
Wake L

[1] Connect the signal wire from an activation sensor or keypad to the input terminal.

[2] To connect to a N.C. device, switch the Input to Wake L. To connect to an N.O. device, switch to Wake H (Active High).

- Inhibit

When using the input for vehicle protection, it is possible to inhibit(Active low) the sensor when the input is triggered.

[1] Connect the sensor disable input signal to "Input" terminal.

[2] To connect to an N.C. device, switch the Input to Inhibit L(Active Low). To connect to an N.O. device, switch to Inhibit H(Active High).

- How to Change the Input

[1] Press the Mode Select button and select [Input] the mode indicator (red).

[2] Press the Value button and select the input of the setting indicator (green).

Every time pressing the button, the input switches from Wake L to Wake H, Inhibit L, Inhibit H, returns back to Wake L.

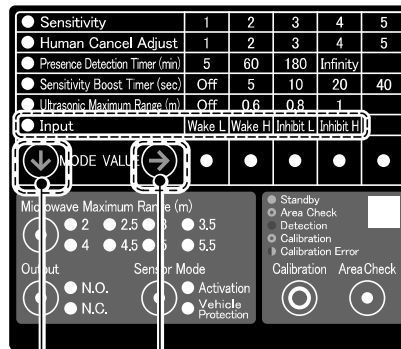

2. Press the Value button to select input.

1. Press the Mode Select button and select [Input].

### NOTE

### Factory Default and Recommended Settings based on the Operation Type

If you have changed the settings from the recommendations, record them in the table below, in the right end column.

Site:

Set Item	Factory default setting	Recommended setting		
		Activation	Vehicle Protection	
Microwave Maximum Range	3.5m(11.48ft.)	3.5m(11.48ft.)	3m(9.84ft.)	
Output	N.O.	N.O.	N.O.	
Sensor Mode	Vehicle Protection	Activation	Vehicle Protection	
Sensitivity	3	3	3	
Human Cancel Adjustment	3	3	3	
Presence Detection Timer	5min	5min	5min	
Sensitivity Boost Timer	Off	Off	Off	
Ultrasonic Maximum Range	1m(3.28ft.)	1m(3.28ft.)	1m(3.28ft.)	
Input	Wake L	N/A		

## 6 Troubleshooting

Symptom	Cause	Action
Operation indicator does not turn ON.	Power may not be supplied.	Connect power supply of 12-24VDC.
	The supply voltage may not be correct.	Check Power supply voltage 12-24VDC.
	The power supply polarity is wrong (wrong polarity does not cause a failure but the product does not work).	Check power supply polarity.
Sensor detection is not conveyed to a system device.	The relay output wiring may not be correct.	Check wiring connection is correct.
	Output contact type is incorrect.	Select the correct output contact type for the system device.
Calibration does not end.	There may be a moving object in detection area.	Remove the pedestrian or moving object (e.g. flag, banner, weeds) in front of the sensor.
The operation indicator blinks in red and blue alternately during calibration (calibration error).	The ultrasonic sensor may have detected a pedestrian or an object such as a signboard in the detection area. There is irregularity on the ground in the sensor's detection area like a grate.	Remove the pedestrian or the object in the detection area if any. If it cannot be removed, reduce the ultrasonic sensing distance.
	The sensor is installed too low and detected the ground.	Install the sensor set so that its bottom surface is 500mm(19.68in.) from the ground.
	The pole to which the sensor is attached or the ground is tilted and the sensor detected the ground.	The sensor set may not work properly if the pole is tilted towards the ground. Attach the sensor to a pole vertical to the ground.
	The direction of the sensor (detection area) is not correct.	Adjust the sensor's direction so as not to be affected by nearby vehicle, wall (fence), and/or gate bar.
	There may be an object on the sensor surface such as chewing gum.	Remove the object.
A vehicle moving the detection area is occasionally or never detected.	Power may not be supplied.	Connect power supply of 12-24VDC.
	The supply voltage may not be correct.	Check Power supply voltage 12-24VDC.
	Calibration may not have been performed correctly.	Perform calibration correctly.
	The direction of the sensor (detection area) is not correct.	Adjust the sensor (detection area) direction for correct detection.
	The sensor may be affected by the background.	Perform calibration again.
	The sensing distance may be too short.	Increase the sensing distance.
	Sensitivity may be too low.	Enhance sensitivity.
The sensor does not revert back to non detection status when a vehicle leaves the detection area, or takes long to change status.	There may be a human, bicycle, large package, weed, or snow. Or, there may be irregularity on the ground in the ultrasonic sensor's detection area such as grating.	Remove the object causing the problem. If it cannot be removed, reduce the sensing distance.
	There may be an object on the sensor surface such as chewing gum.	Remove the object.
	Calibration may not have been performed correctly.	Perform calibration again.
	The direction of the sensor (detection area) is not correct.	Adjust the sensor (detection area) direction to the correct detection.
	OFF-delay time may be too long.	Reduce the OFF-delay time.
The gate bar is detected. The gate bar repeatedly opens and closes.	Sensitivity may be too high.	Reduce sensitivity.
	The sensing distance may be too long.	Reduce the sensing distance.
	The sensor installation position may be too close to the bar.	The sensor must be installed away from the gate bar by 700mm(27.56in.) or more.
	The direction of the sensor (detection area) is not correct.	Adjust the direction of the sensor (detection area) so as to be parallel to the gate bar.
	The gate bar may have a curtain.	Remove the curtain.



Symptom	Cause	Action
The sensor detects a vehicle passing out of the detection area.	Sensitivity may be too high.	Reduce sensitivity.
	The sensing distance of the microwave may be too long.	Reduce the sensing distance of the microwave.
	The direction of the sensor (detection area) is not correct.	Adjust the sensor (detection area) direction for correct detection.
The sensor detects a pedestrian passing in the sensor's detection area.	Sensitivity may be too high.	Reduce sensitivity.
	The sensor mode may not be correct.	Check if the sensor mode is appropriate for the installation considerations.
	More than one pedestrian may be passing.	The sensor may detects a crowd. Take steps so that people should not pass through the area.
The sensor detects a pedestrian with large baggage or a metal object passing in the sensor's detection area.	Sensitivity may be too high.	Reduce sensitivity.
	The metal object or baggage is too large.	The sensor may not discriminate a large object from a vehicle. Take steps so that people should not pass the area.
Sensor's detection is too late. It should detect earlier (start detecting at a further distance).	Sensitivity may be too low.	Enhance sensitivity.
	The sensing distance of the microwave may be too short.	Increase the sensing distance of the microwave.
	The sensor mode may not be correct.	Check if the sensor mode is appropriate for the installation considerations.
Detection by the sensor for activation and a passing vehicle detection cannot be logically multiplied.	Sensitivity may be too low.	Enhance sensitivity.
	The direction of the sensor (detection area) is not proper.	Adjust the sensor (detection area) direction for correct detection.
	The sensing distance of the microwave may be too short.	Increase the sensing distance of the microwave.
	OFF-delay time may be too short.	Increase the OFF-delay time.
A vehicle turning right after leaving the parking lot is not detected.	Sensitivity may be too low.	Enhance sensitivity.
	The sensitivity boost timer may have been disabled.	Enable the function of sensitivity boost timer
	Time period of sensitivity boost timer may be too short.	Increase the time period of sensitivity boost timer.

If you still can't solve the problem even after following the instructions above, contact our sales representative or sales office.

# 7 Specifications

## 7-1 Specifications

Name		ViiK Gate (Vehicle Detection Sensor for Gate)
Model		OVS-01GT
Detection Method		Combination of microwave (Doppler shift, FMCW technologies) and ultrasonic wave
Sensor Frequency		Microwave : 24GHz, Ultrasonic : 56kHz
Response		500msec
Supply Voltage		12 - 24VDC
Power Consumption		Heater enabled: Up to 200mA, Heater disabled : Up to 80mA (at 24V)
Output		Relay output DC30V, 0.3A (N.O. / N.C. switchable)
Input		Active Low / High switchable
Sensing Distance	Microwave Sensor	0.8 to 5.5m (2.63 to 18ft.), Max. range adjustable
	Ultrasonic Sensor	0.1 to 1m (0.33 to 3.28ft.), Max. range adjustable
Detectable Vehicle Speed		2 - 20 kph (1.24 - 12.43mph)
Device Setting	Sensitivity	Level 1 to 5
	Human Cancel Adjust	Level 1 to 5
	Presence Detection Timer	5 / 60 / 180 / Infinity min
	Sensitivity Boost Timer	Off / 5 / 10 / 20 / 40 sec
	Input	Wake L / Wake H / Inhibit L / Inhibit H
	Output	N.O. / N.C.
	Microwave Maximum Range	2 / 2.5 / 3 / 3.5 / 4 / 4.5 / 5 / 5.5 m (6.56 / 8.20 / 9.84 / 11.48 / 13.12 / 14.76 / 16.40 / 18.04 ft.)
	Ultrasonic Maximum Range	Off / 0.6 / 0.8 / 1 m (Off / 1.97 / 2.62 / 3.28 ft.)
Indicator	Sensor Mode	Activation / Vehicle protection
	Normal Operation	Standby: Solid Green, Detected: Solid Red, Unsuitable environmental notification: Slow Blinking Green
	Detection Area Check	Non detection: Blinking Green, Microwave sensor detected: Blinking Yellow Microwave sensor detected: Blinking Purple, Microwave/ultrasonic sensor detected: Blinking Red
	Calibration	Getting Ready: Slow Blinking Blue, Calibrating: Quick Blinking Blue, Ultrasonic sensor detection error: Alternate Blinking Red-Blue
	Sensor Reset	Reset Complete: Solid Yellow for 2 seconds
Human Cancellation Function Operating		Yes (except for the setting of sensitivity level 5)
Ambient Temperature		-30 to 50°C (-22 to 122 F)
Operating Ambient Humidity		95% max. (no condensation)
Degree of Protection		IP65
Installation Location		Indoor / Outdoor
Installation Height		500mm(19.69in.) (distance from the ground to the bottom of the unit)
Sensor Angle Adjustment		Left and Right: ±30 degrees (5-degree step)
Weight		420g (14.82 oz)
Accessories		Retaining screws x 4, Installation manual (this document)

Specifications are subject to change without notice for improvement.

<Notice>

Please note that we are not responsible for any damage that occurred when the equipment was operated or installed improperly.

## 7-2 Detection Area Diagram

Top View

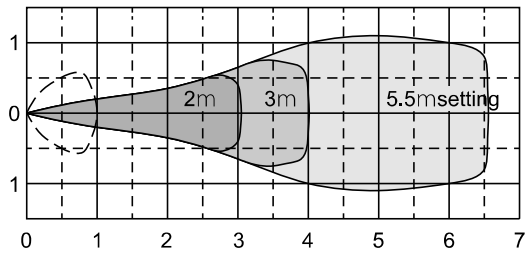

Side View

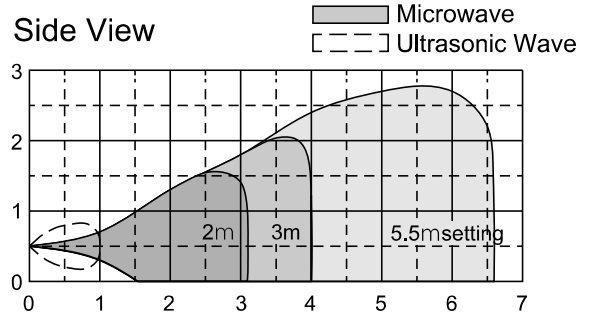

[Unit: m]  
1m=3.28ft.

Installation height 0.5m(1.64ft.), Operation type: Device activation, Sensitivity: 3,

Ultrasonic sensor sensing distance: 1m(3.28ft.), Detection area check mode

\* Under normal operation, the detection area by an actual vehicle may be smaller.

## 7-3 Dimensions

[Unit:mm(inch)]

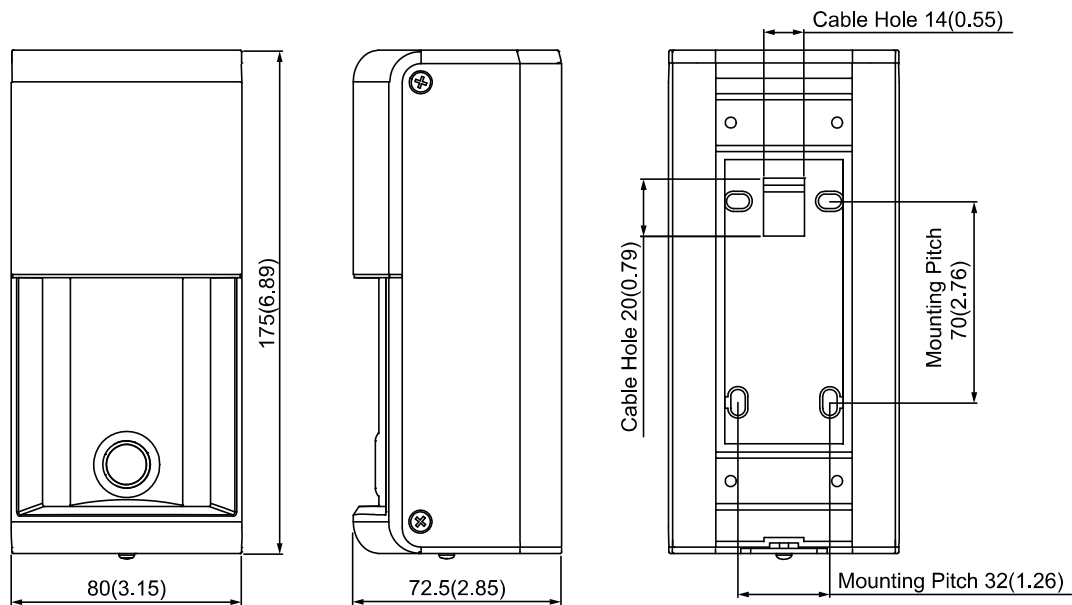

Hereby, OPTEX declares that the radio equipment type OVS-01GT is in compliance with RED 2014/53/EU. The full text of the EU DoC is available at the following internet address: [www.optex.net](http://www.optex.net)

EU contact information

Manufacturer:

OPTEX CO., LTD. 5-8-12 Ogoto, Otsu, Shiga, 520-0101 JAPAN

Authorised representative in Europe:

OPTEX (EUROPE) LTD. / EMEA HEADQUARTERS

Marandaz House 1 Cordwallis Park, Clivemont Road, Maidenhead, Berkshire, SL6 7BU, U.K.

Microwave emission Frequency and Power: 24.05 - 24.25 GHz 30mW e.i.r.p

FCC NOTICE

The following information must be indicated on the host device of this module; Contains FCC ID: DC9-OVS01 This device complies with part 15 of the FCC Rules. Operation is subject to the following two conditions:

(1) This device may not cause harmful interference, and (2) this device must accept any interference received, including interference that may cause undesired operation.

FCC WARNING(For USA)

Changes or modifications not expressly approved by the party responsible for compliance could void the user's authority to operate the equipment.

-NOTICE-

This equipment has been tested and found to comply with the limits for a Class B digital device, pursuant to part 15 of the FCC Rules. These limits are designed to provide reasonable protection against harmful interference in a residential installation. This equipment generates, uses and can radiate radio frequency energy and, if not installed and used in accordance with the instructions, may cause harmful interference to radio communications. However, there is no guarantee that interference will not occur in a particular installation. If this equipment does cause harmful interference to radio or television reception, which can be determined by turning the equipment off and on, the user is encouraged to try to correct the interference by one or more of the following measures:

-Reorient or relocate the receiving antenna.

-Increase the separation between the equipment and receiver.

-Connect the equipment into an outlet on a circuit different from that to which the receiver is connected.

-Consult the dealer or an experienced radio/TV technician for help.

-NOTICE-

1.The antennas cannot be exchanged.

2.To comply with FCC RF exposure compliance requirements, a separation distance of at least 20cm must be maintained between the antenna of this device and all persons.



**OPTEX CO.,LTD. (JAPAN)**

(ISO 9001 Certified) (ISO 14001 Certified)

5-8-12 Ogoto Otsu Shiga 520-0101 JAPAN

TEL:+81-77-579-8670

FAX:+81-77-579-8190

URL:<http://www.optex.co.jp/e/>

**OPTEX INC. (USA)**

TEL:800-877-6656 (Toll free)

FAX:+1-310-898-1098

URL:<http://www.optexamerica.com/>

**OPTEX (EUROPE)LTD. (UK)**

TEL:+44-1628-631000

URL:<http://www.optex-europe.com/>

**OPTEX SECURITY SAS (FRANCE)**

TEL:+33-437-55-50-50

URL:<http://www.optex-security.com/>

**OPTEX SECURITY Sp.zo.o. (POLAND)**

TEL:+48-22-598-06-55

URL:<http://www.optex.com.pl/>

**OPTEX KOREA CO., LTD. (KOREA)**

TEL:+82-2-719-5971

URL:<http://www.optexkorea.com/>

**OPTEX (DONGGUAN) CO., LTD.**

**SHANGHAI OFFICE (CHINA)**

TEL:+86-21-34600673

URL:<http://www.optexchina.com/>