

Contents

Hy5B Vehicle Detector Features 1
 Table 1: LED Display Status..... 1
Hy5B Installation 2
 Test the Vehicle Loop..... 2
 Check the Version of Software..... 2
 Install Hy5B Vehicle Detectors..... 2
 Table 2: Vehicle Loop Sets 3
Test Loop and Gate Operation 4
 Advanced Loop Configuration via the Installer Menu 4
 Accessing the Installer Menu 4
 Table 3: Menu Mode Navigation Buttons 4
 Setting Gate Function for Reversing Loops 5
 Viewing and Configuring Loop Set Features..... 5
 Table 4: Loop Frequency, Sensitivity, and Presence 5
 Table 5: Sensitivity Settings via the Installer Menu 5
 Loop Health 6
 Loop Presence 6
 Table 6: Setting Loop Presence 6
Technical Support 7
 Troubleshooting..... 7
 Table 7. Troubleshooting Tips 7
Hy5B Loop Health Scores..... 9
 Loop Noise Score 9
 Table 8. Loop Noise Score 9
 Possible Causes of Loop Noise 9
 Loop Step Changes Score 9
 Table 9. Loop Step changes Score 9
 Possible Causes of Loop Step Changes: 9
 Loop Reference Changes Score 10
 Table 10. Loop Reference Changes Score 10
 Possible causes of loop reference changes: 10
How a Vehicle Detector Works..... 11
Site design considerations:..... 11
Loop Wire Installation 12
 Table 11: Loop Wire Considerations 12
 Loop Phasing 12

Hy5B Vehicle Detector Features

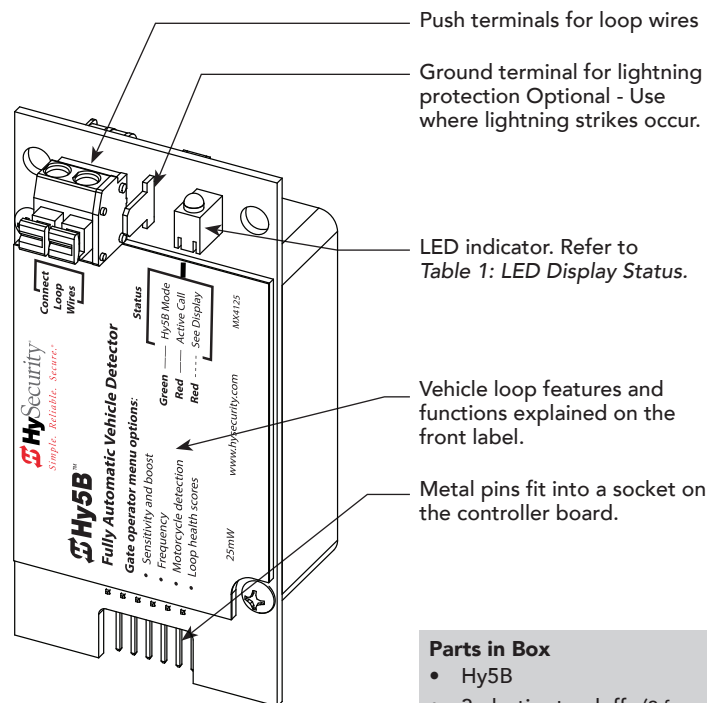

Diagram 1. Hy5B Vehicle Detector – front view

- Parts in Box**
- Hy5B
 - 3 plastic standoffs (2 for Hy5B install, 1 extra)
 - Installation Instructions
- Tools Needed**
- Wire cutters
 - Wire strippers
 - Needle nose pliers

- **Automatic Sensitivity** – The Hy5B monitors vehicle traffic over the loop and automatically adjusts the loop sensitivity based on vehicle type and volume.
- **Automatic Gate Compensation** – The Hy5B discerns gate travel over the loop and automatically compensates for its effect. The compensation allows the Hy5B to operate with a higher sensitivity which provides better detection capability.
- **No Loop Crosstalk** – Exclusive use of Hy5B vehicle detectors in HySecurity gate operators, completely eliminates crosstalk and the need to set frequency levels.
- **Vehicle Counting** – Hy5B detects passenger vehicles and motorcycles.
- **Automatic Lightning Suppression** - Where lightning strikes occur often, connecting to the ground terminal minimizes the chance of activation or lock-up.
- **Health Scores for Loop** – Hy5B monitors the loop for changes that are indicative of possible problems. A score is accessible through the event log, LG menu item.
- **Automatic Hy5A emulation mode** for backward compatibility.

Table 1: LED Display Status

LED Activity	Indicates	Condition & Resolution
OFF	Hy5A mode	Emulation mode. Some Hy5B features are unavailable.
GREEN PULSING	Heart beat	Normal operation.
RED ON	Call Mode	Status indicates loop activation in process.
RED FLASHING	View display for more information: <i>Initializing or Faulty loop</i>	If initializing, wait until initialization is complete. If flashing during loop operation, take following steps: 1. Check loop wiring. See <i>Test the Vehicle Loop on page 2</i> . 2. Replace loop. 3. If loop is not at issue, swap out Hy5B vehicle detector with a known operational Hy5B. 4. If necessary, replace Hy5B.

Hy5B Installation

To install an Hy5B vehicle detector, you will need to take the following steps:

- Test the vehicle loop
- To use all the features of Hy5B, update the software version on the gate operator to the latest version using S.T.A.R.T. and a PC laptop. Access free software updates from the HySecurity website: www.hysecurity.com
- Install the Hy5B vehicle detector
- Fully cycle the gate at least 2 times to allow the detector to adjust to the effects of the gate during travel. Drive a test vehicle over the loops.

Test the Vehicle Loop

Run diagnostic tests on the vehicle loops before installing Hy5B vehicle detectors to ensure the loops are in good working condition. The following tests cannot guarantee a functioning loop, but failure of either test means that the loop may be damaged or need to be replaced.

1. Test – Measure the resistance of the loop and lead-in wire. It should not exceed 4.0 ohms.
2. Test – Measure the resistance to earth ground with a Megohmmeter (Megger). It should be 100 Megohms or more. Below 50 mega-ohms, install a new loop.

NOTE: Loops may function at 100 Megohms or less, but will not be reliable (for example, when the ground is wet from rainfall). A low megohm reading on the resistance to earth ground usually occurs due to broken or moisture saturated insulation. Be sure to use wire with a direct burial jacket such as XLPE or XHHW wire. Do NOT use THHN wire.

Check the Version of Software

1. In the field, open the gate operator's Control Box.
2. To view the software version, press the RESET key. To use Hy5B features, the software version must be h4.55 or h5.56 (or higher). Otherwise, the Hy5B reverts to Hy5A emulation mode.
3. If you wish to update the software, download the current S.T.A.R.T. software to your PC laptop, and then load the gate operator code to the controller board before installing Hy5B vehicle detectors. See www.hysecurity.com for updates.



NOTE: Hy5A emulation mode does not include all the features of Hy5B. If you are replacing Hy5A detectors and updating the gate operator software, be aware Build Year 1 (BY1) or Build Year 2 (BY2) will need to be addressed. BY2 requires monitoring of external entrapment protection sensors per UL 325 - 2016 Standard of Safety. If the gate operator was installed prior to 2016, BY1 may be used. For more information, refer to the gate operator's product manual.

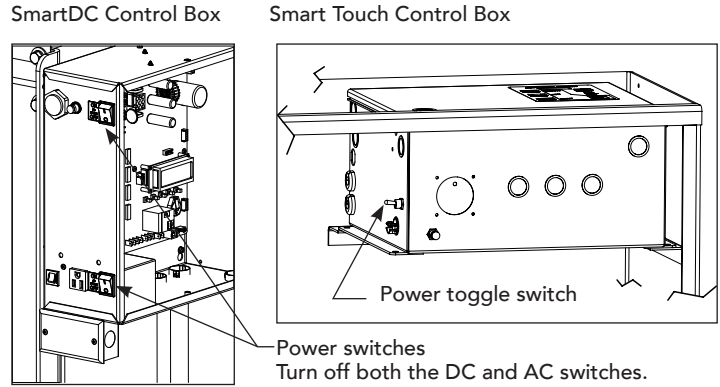

Diagram 2. Control Boxes

Install Hy5B Vehicle Detectors

Install one Hy5B detector at a time. Each vehicle detector socket is labeled as shown in column 2 of *Table 2: Vehicle Loop Sets*.

1. Turn power OFF in control box. See *Diagram 2. Control Boxes*.
2. Insert the squared-off end of the plastic standoff through the hole in the Hy5B detector. See *Diagram 3. Insert Plastic Standoffs*.
3. To minimize excessive flexing, keep each Hy5B perpendicular to the control board as you plug it into the Hy5B socket.
4. Secure the Hy5B by inserting each plastic standoff into the chassis.
5. Place the two wires from the loop into the push terminals of the Hy5B. For ease of installation, the wire gauge should be 20 - 14 AWG.

NOTE: If you have more Hy5B detectors, repeat the steps 2 through 4 for each additional Hy5B detector.

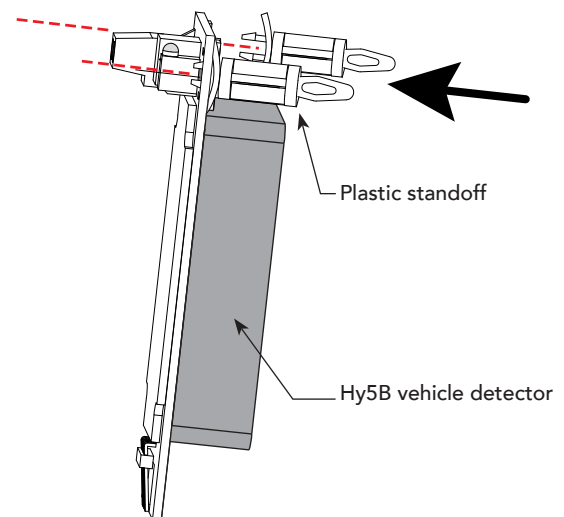

Diagram 3. Insert Plastic Standoffs

Table 2: Vehicle Loop Sets				
Loop Type	Installer Menu	Loops Smart DC	Loops Smart Touch	Description
Exit Loop	ELD	EXIT LOOP	FREE EXIT	Opens a fully-closed gate.
Inside Reversing Loop	ILD	INSIDE OBSTRUCTION	INSIDE OBSTR	Connects to the inside reversing loop.
Outside Reversing Loop	OLD	OUTSIDE OBSTRUCTION	OUTSIDE OBSTR	Connects to the outside reversing loop.
Reset/Shadow/Center	SLD/CLD	CENTER LOOP	SHADOW / RESET	Prevents a gate from starting open or closed when a vehicle is in the path of the gate.

- Turn power to the gate operator back ON.
- The Hy5B indicator light flashes red and the following appears.

Smart Touch 7-segment Display	STC (OLED) and Smart DC Displays
Initial	INITIALIZING

- When the LED on the Hy5B detector stops flashing red, it begins pulsing green which indicates **initialization is complete** and the detector is **ready for use**.

NOTE: If using Hy5A emulation mode, the LED does not flash green, it goes dark. Refer to *Table 1: LED Display Status on page 1*. The pulsing green LED indicates Hy5B mode.

- Press the Reset button.
When you press Reset, the following occurs:
 - Checks Hy5B loop connections and re-tunes Hy5B to prevent crosstalk
 - Un-installs memory of vehicle detectors physically removed
 - Clears alerts

NOTE: If the Hy5B is unplugged after it is initialized, an alert appears on the display, ALERT 10. If the issue is not resolved, ERROR 3 appears. When faults of this nature occur, the gate operator functions as if the Hy5B is triggered.



Do not connect Free Exit loop wires to the same Hy5B detector containing obstruction loop wires (reversing loops). You cannot combine Free Exit vehicle detection with reversing loop detection. If you attempt to do so, vehicles crossing over the Free Exit will not be detected.

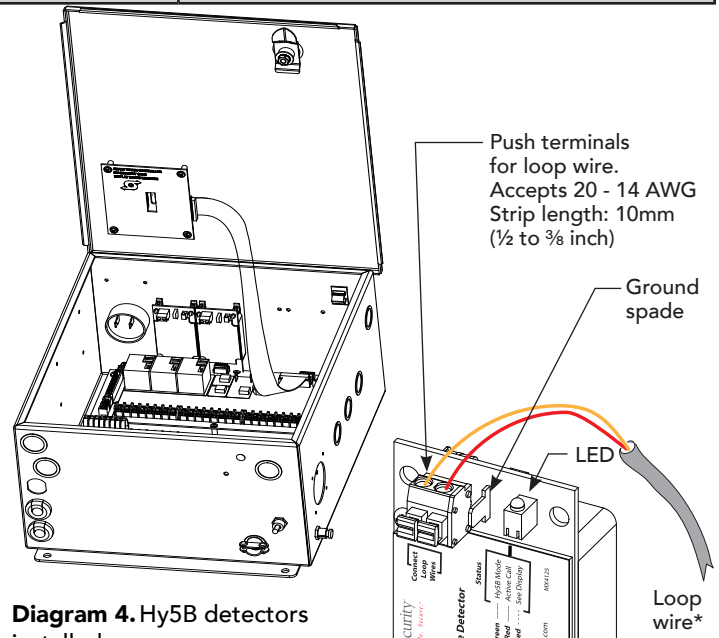
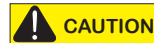

Diagram 4. Hy5B detectors installed



Do not leave excess loop wire coiled in the control box because it can generate false calls.

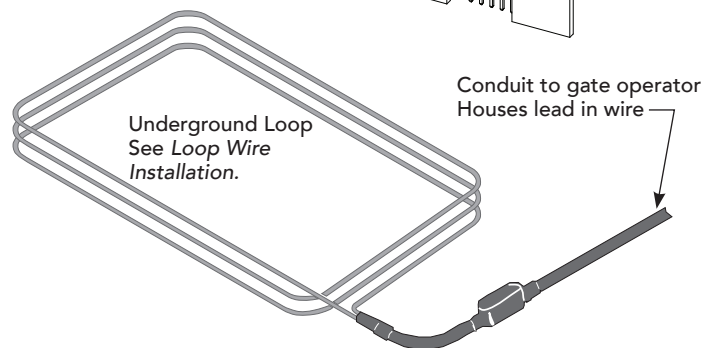

Diagram 5. Loops and Hy5B

***NOTE:** If connecting more than one reversing loop, wiring must be in series (not in parallel). Combine loops in series by tying together one lead from each loop (crimp or solder wires). Insert remaining leads (one from each loop) into the Hy5B vehicle detector set in either the OOLD or IOLD socket.

Test Loop and Gate Operation

NOTE: The Hy5B automatically tunes itself to gate movement during the first gate cycle and incorporates boost memory on the second open/close cycle. The effects of the passing gate are learned and the Hy5B software masks it for future gate cycles. This feature increases the ability to detect smaller vehicles without falsely detecting the gate and provides a more accurate vehicle count.

1. To initialize Hy5B automatic sensitivity and boost, use a vehicle to drive over the loops and perform a minimum of 3 gate open/close cycles. Make sure the vehicle crosses over all loops.
2. When the gate operator and vehicle loops are functioning properly, carefully replace the gate operator's cover and secure it to the chassis.

NOTE: When you turn on both DC and AC power switches for SlideSmart DC, StrongArmPark DC and WedgeSmart DC the gate, wedge, or arm will move while searching for its home target.

Advanced Loop Configuration via the Installer Menu

Access to the Installer Menu allows you to:

- Override Hy5B auto-sensitivity
- View the call level, sensitivity, loop inductance, or health in real time
- Set frequency (if using a combination of Hy5B and box vehicle detectors)
- Set call detection presence

NOTE: Installer Menu options can also be configured through the use of a laptop computer and S.T.A.R.T. See Smart Touch Analyze and Retrieve Tool information found on the HySecurity website: www.hysecurity.com

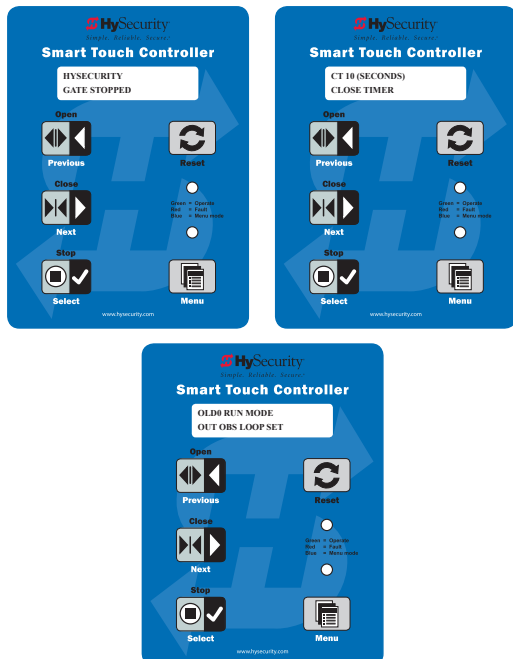

Diagram 6. Smart Touch Gate Status Displays

Accessing the Installer Menu

To access the Installer Menu, a gate status must appear on the display (Examples: Gate Stopped, Gate Open, Gate Closed).

1. Press the Menu button twice.
2. Access the Installer Menu by simultaneously pressing and holding the Reset and Open buttons.
3. Release both buttons and the display changes, indicating you have arrived at the first item in the Installer Menu.
4. Use the Next or Previous buttons on the keypad to navigate to a Loop Set socket. See *Table 2: Vehicle Loop Sets on page 3*. For more information on navigating within Menu Mode, refer to Table 3.

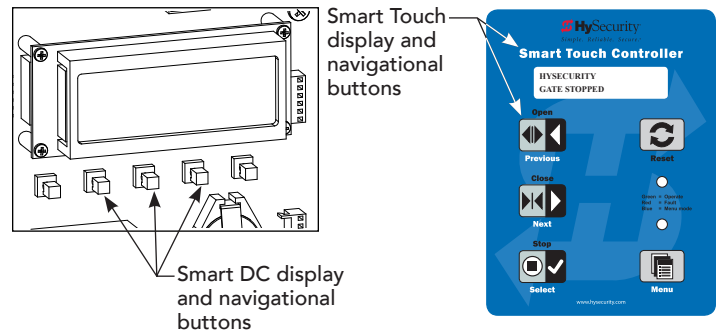

Diagram 7. Keypads

Table 3: Menu Mode Navigation Buttons	
To change data appearing in the display	Press Select. Two left characters blink.
To navigate through the Selections	Press Next or Previous. Continue pressing Next to view all selections.
To choose what appears on the display	Press Select. Blinking characters become static.
To navigate between menu items	Press Next or Previous Advance - press Next Precious - press Previous

Setting Gate Function for Reversing Loops

The default setting for a call (detection) on reversing loops is to stop and reverse the gate to full open. The gate operator can be reconfigured to pause gate closure, and then continue traveling in the same direction. To make changes to the setting, you need to access the Installer Menu.

The abbreviated item names appear in the menu as:

7 Segment Display	Smart Display	Description
0r 1	OR 1	Outside Obstruction Loop Detector
1r 1	IR 1	Inside Obstruction Loop Detector

The tables below describe the Hy5B items that appear in the Smart Touch or Smart DC Installer Menu.

1. Review the label associated with the socket containing the Hy5B vehicle detector.
2. Access the Installer Menu and select the menu item associated with the Hy5B socket. See *Table 2: Vehicle Loop Sets*.
3. When the Installer Menu item is displayed, press SELECT.
4. Press NEXT to scroll through the sub-menu. See tables.
5. Press SELECT to change menu item data (if allowed).
6. To learn how to navigate and select items within the menu tree, refer to, *Table 3: Menu Mode Navigation Buttons on page 4*.
7. To exit to Run Mode, press Menu.

For more information about free exit loop and detector logic settings, refer to your gate operator's product manual.

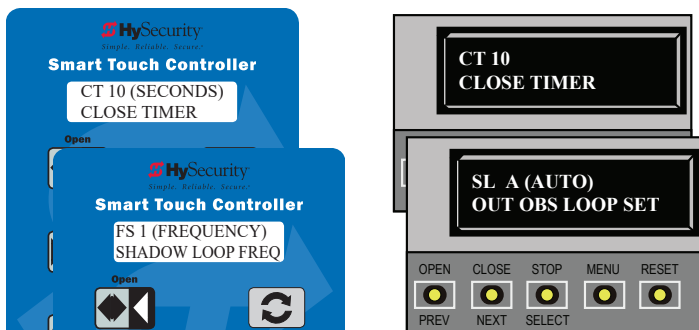

Diagram 8. Installer Menu Displays

Viewing and Configuring Loop Set Features

Installer Menu Sub-menu Item	Display	Description
1	SHOW FREQ	Show loop frequency
2	CALL LEVEL	Show CALL strength
3	SET FREQ	Change the frequency setting
4	SHOW SENS	Show the sensitivity setting
5	SET SENS	Change the sensitivity setting
6	SHOW INDUC	Show the loop inductance
7	SHOW HEALT	Show the loop health scores
8	SET PRESEN	Change the CALL hold time setting

NOTE: Do not exceed more than 200 square feet (61 square meters) of loop area to one detector. The detection height is roughly 2/3's the size of the shortest side of the loop.

As a basic guide, if manually reconfiguring loop sensitivity settings, consider:

- On a standard-sized 6 x 6 loop, 0 (with boost) and 4 provide the lowest sensitivity.
- As the loop's square foot area increases beyond standard-size, it requires a higher sensitivity number to detect same-sized vehicles.

Hy5B Sensitivity	LOOP SET Display	Description
A	(AUTO)	Hy5B only: Default setting. Automatically monitors vehicular traffic pattern and adjusts sensitivity. Boost feature enabled.
M	(MOTORCY)	Hy5B only: Automatically adjusts threshold to incorporate sensitivity for motorcycles. Boost feature enabled.
0	(LOW BST)	Hy5B: Lowest sensitivity. Boost enabled. *
1	(NORM BST)	Hy5B: Boost enabled. *
2	(HI BST)	Hy5B: Boost enabled. *
3	(XHI BST)	Hy5B: Highest sensitivity. Boost enabled. *
4	(LOW)	Hy5B: Lowest sensitivity. No boost. *
5	(NORM)	Hy5B: No boost. *
6	(HI)	Hy5B: No boost. *
7	(XHI)	Hy5B: No boost. *

NOTE: A boost feature is needed for detecting unusual vehicular traffic patterns or to assist when environmental factors (electrical or radio interference) exist. Boost increases the sensitivity during a call and is useful for maintaining continuous detection if the signal becomes weak. * The Hy5B sensitivity numbers equate to the Hy5A sensitivity dial. In Hy5A emulation mode, the Hy5B remains in AUTO mode until modified through the Installer Menu settings.

Loop Health

The Hy5B monitors loop health which is comprised of loop noise, loop step changes and loop reference changes. Loop health readings accumulate throughout a 24 hour period and the accrued readings are posted to the Event Log each day at midnight. After midnight, the loop health baseline resets to its highest value of 777.

Example of an Event Log posting:

```
Event log:
02/09 EVENT - CLD Loop Health: noise 5, step 6, ref 7
```

Loop Presence

Loop presence is dependent on "disturbance effect" of the entire vehicle. Presence determines how long to hold the "memory" of a stationary vehicle on a loop before it is forgotten and ignored. Set the presence of the loop:

- LONG (default) lasts about 20 hours dependent on call strength and sensitivity setting. The Hy5B tunes out the "disturbance effect" when a vehicle is stationary on a portion of the loop, but keeps the undisturbed (unaffected) portion of the loop operational.
- INFINITE never drops the call. The INFINITE setting requires a certain amount of signal strength. A "threshold" is maintained and it will hold the call forever. The loop connected to an Hy5B with this setting may become non-functioning.

Table 6: Setting Loop Presence		
Installer Menu Sub-menu Item	Display	Example Site Scenario
PR 0	(LONG)	With the sensitivity set to A (AUTO) and a large sedan stationary on the loop, LONG presence may hold the call for many hours before the vehicle's presence is tuned out. Then, the stationary vehicle is ignored and the unaffected portion of the loop becomes operational. In contrast, with the sensitivity set to M (MOTORCYCLE), the default threshold only lasts about 1 hour before the presence of the motorcycle on the loop is tuned out.
PR 1	(INFINITE)	A site where standing or parked vehicular traffic (on large area loops) is a daily or consistent basis, the INFINITE presence setting is a viable option. When the loop may have vehicles parked on it for more than several hours and it must hold the call, set the presence to INFINITE.

NOTE: The Hy5B has the ability to continue counting vehicles passing over the loop even though a stationary vehicle may be on a portion of the loop. The controller and Hy5B detector also exchange pertinent information, so if a power failure were to occur, the controller can determine if a vehicle is on the loop when power returns.

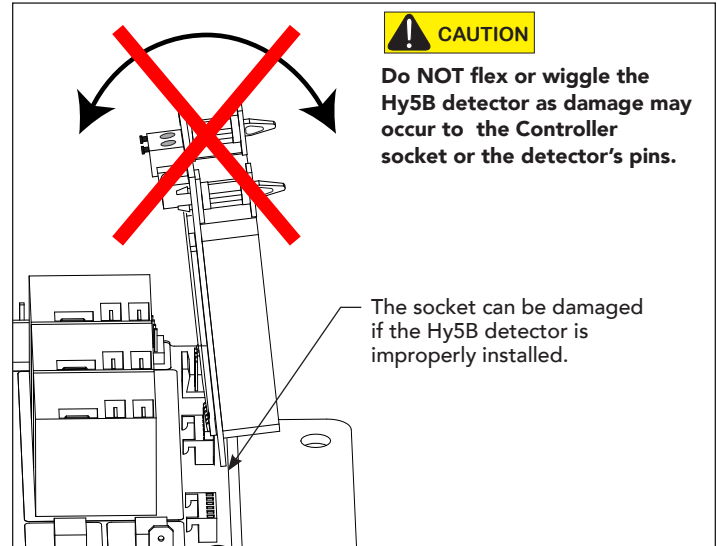

Diagram 9. Incorrect Installation

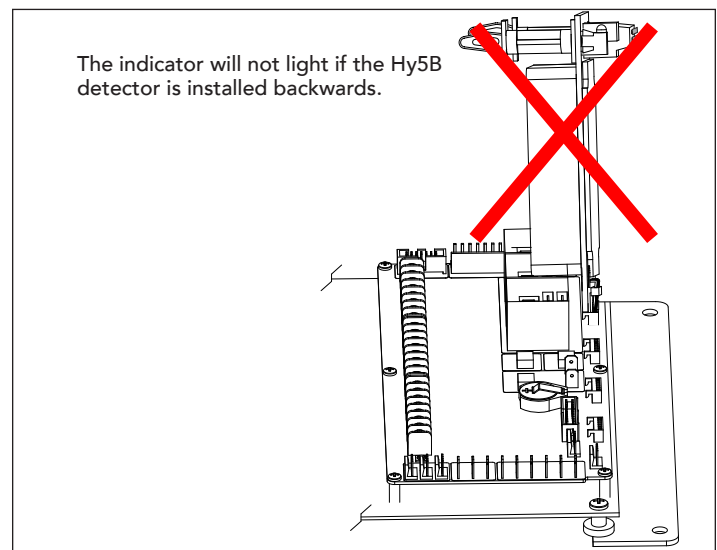

Diagram 10. Incorrect installation

Technical Support

For technical support, call your installer or authorized HySecurity distributor. Obtain the serial number of your operator before calling. For the name of a distributor near you, contact HySecurity at 800-321-9947.

Troubleshooting

The gate operator display shows vehicle detection alerts, faults and errors which can help in troubleshooting loop issues. For a full list of error codes, refer to the gate operator's product manual.

Check that you have accomplished the following, *before* calling Tech Support:

- Tested loop viability and gate operation. Using a vehicle to cross the loops, cycle the gate open & close at least two times to allow for automatic tuning to gate movement and to set appropriate thresholds in Hy5B memory.
- Correctly installed and initialized the Hy5B.
- If two loops are attached to the same Hy5B detector, make sure loops are **identical in length and width and number of windings**. If loops are odd shaped or not identical in form, you may need to manually adjust sensitivity via the Installer Menu or re-install the vehicle loops. For more information, refer to *Loop Phasing on page 12*.
- Check the display for descriptive messages.
- If you're planning to use Hy5B features, verify that the software version on the gate operator is the latest version. To view the software version, press the Reset key.
- Check Loop Health via the Installer Menu. To access loop health (SHOW HEALT), select the associated socket abbreviation. See *Table 2: Vehicle Loop Sets*. Scores on the low scale (0 through 5) indicate issues. A perfect Health score is 777. See *Hy5B Loop Health Scores on page 9*.

Table 7. Troubleshooting Tips

Symptoms	Problem	Resolution
Intermittent detection. False vehicle loop detection.	Phantom lockups - no vehicle over loop and detector goes into call mode. Chattering - Hy5B changes call states without evidence of vehicle. Symptoms can also occur when the Hy5B detector is seated improperly during installation. Do NOT flex the module into place. See Diagrams 9 & 10. The Hy5B module remains undamaged, but the socket on the Controller has been loosened or damaged.	Intermittent detection can be caused by bad or loose electrical connections. Wire nuts should never be used to splice loop connections. The preferred method of splicing loop wires is soldering or crimping. Any screw terminals should be checked for tightness. 1. If the Hy5B is mixed with box detectors, try changing the frequency of the Hy5B detector. 2. Access the Event Log. (User Menu setting, LG). Call levels and Health scores appear in the event log. Assess sensitivity settings and loop health. 3. To verify that the Hy5B is working correctly, exchange the vehicle detector for one known to be "working correctly." Reseat and re-initialize. See <i>Diagram 3. Insert Plastic Standoffs on page 3</i> . 4. Run both tests discussed in <i>Test the Vehicle Loop on page 2</i> .
Gate does not always open or close when a vehicle crosses the obstruction loops.	Most likely, the Hy5B detectors were connected to the controller as a group and then initialized.	1. Individually install each Hy5B module. 2. Wait until the indicator light turns off before pressing the Reset button and installing the next Hy5B detector.
No indicator light appears on the Hy5B detector.	Hy5A emulation mode. Normal operation. If you planned to use Hy5B mode, the Hy5B detector is installed backwards or it could be defective.	1. Disconnect the loop. If the LED flashes red, the loop and vehicle detector are working properly. 2. Check the orientation of the Hy5B detector and re-install it, if necessary. If using Hy5B mode, a green LED indicator should blink when the detector is operating properly.
ALERT 7 FREQ SHIFT FAULT	Hy5B detector has detected a frequency change outside the normal range.	1. Test loop viability. See <i>Test the Vehicle Loop on page 2</i> . 2. Electrical or radio interference causing problems in the area? 3. Check wiring integrity of the loops.
ALERT 8 LOOP SHORTED	Hy5B detector has detected a short circuit in the loop.	An ALERT 8 can be an indication that the coiled loop wire does not have enough turns in it. 1. To be sure the loop is at fault, temporarily switch detectors. Check if ALERT 8 continues to appear. 2. If the error continues, repair the loop.
ALERT 9 LOOP OPEN	Hy5B detector has sensed that the loop has become an open circuit.	1. Check all loop wiring connections. 2. If needed, use an ohmmeter to find out where the break is in the loop.





Table 7. Troubleshooting Tips

Symptoms	Problem	Resolution
ALERT 10 I ² C BUS ERROR	Communications error alert.	Hy5B has been removed or a lack of integrity in the socket connection exists. The display indicates which detector the alert applies to: Exit Loop (ELD), Inside Obstruction Loop (ILD), Outside Obstruction Loop (OLD), Center Loop (CLD). <ol style="list-style-type: none">1. Remove and re-install the Hy5B2. Press RESET.3. Replace the Hy5B, if necessary. If communication is not re-established within 30 seconds, the controller will reset and the message changes to ERROR 3.
ALERT 11 DETECTOR FAULT	Unknown fault.	<ol style="list-style-type: none">1. Perform the megaohm test and fix the loop, if necessary.2. Replace the Hy5B if the problem continues.
ALERT 12 ON TOO LONG	The detector believes there has been a vehicle on the loop for more than 5 minutes.	<ol style="list-style-type: none">1. Is there something metal on (or near) the loop? For example, manhole covers?2. Is the sensitivity set too high? If mixed with box detectors, cross-talk can occur. Use only Hy5B detectors or change the Hy5B frequency setting.3. Is the roadway solid? If the underground loop moves, it will give false readings. Does the loop cross an expansion joint? Also, preformed loops in PVC can experience wire displacement inside the PVC pipe. A problem may exist with the loop itself. New loops should read 100 mega-ohms or better, between 50 and 100 operation are generally OK. See <i>Test the Vehicle Loop on page 2</i> .
ERROR 3 Hy5B FAILED	One or more detectors are not communicating properly.	<ol style="list-style-type: none">1. Remove detectors.2. Reset the controller.3. Re-install detectors one at a time until faulty detector or loop is found.

Hy5B Loop Health Scores

Loop Noise Score

Score	Meaning	Possible Impact on Gate Operation
7	Near perfect, no discernable noise	None
6	Very slight noise	None
5	Some noise	Not likely - Holding detects
4	Enough noise to be a concern	Not likely - False detects, holding detects
3	Noise probably impacting operation	Likely - False detects, holding detects
2	Significant noise	Likely - False detects, holding detects, will not reset
1	Very significant noise	Very likely - False detects, holding detects, will not reset
0	Severe noise	Very likely - False detects, holding detects, will not reset

Possible Causes of Loop Noise

- Inductively-Coupled Loop Cross-talk – This is interference between two or more active loops. If all detectors used are Hy5Bs, this is not the source of the noise as the operator turns on and off each detector in sequence to ensure that this type of cross-talk cannot occur. If you are experiencing this issue, installing all Hy5Bs will be the most effective mitigation technique. If this is not possible, changing the frequency of one or both of the loops that are interfering usually reduces the cross-talk to acceptable levels.
- Capacitively-Coupled Interference – This is interference between electrical wiring in close proximity to each other (usually in the same conduit) for significant distances (usually 50 feet or more). The longer the distance the more pronounced the effect. Twisting of the loop wires will help with this. If a shielded cable is used for the loop wires, the shield of the cable should be left floating (unconnected) at both ends.
- Other Electrical Interference – This is usually interference that is coupled in to the loop, lead-in, or detector itself. Changing the loop frequency on the detector may help. If the interference is coupling in to the loop itself, a figure 8 loop may be needed to mitigate the source of interference. If the interference is at the detector, additional shielding may be needed.

Loop Step Changes Score

Score	Meaning	Possible Impact on Gate Operation
7	No step changes recorded	None
6	One step change recorded	Possible - False detects, locked in call
5	2 to 3 step changes recorded	Likely - False detects, locked in call
4	4 to 5 step changes recorded	Likely - False detects, locked in call
3	More than a few step changes recorded	Very likely - False detects, locked in call
2	Significant number of step changes recorded	Very likely - False detects, locked in call
1	Very significant number of step changes recorded	Very likely - False detects, locked in call
0	Severe number of step changes recorded	Very likely - False detects, locked in call

Possible Causes of Loop Step Changes:

- Loose Electrical Connections – If there are any splices in the loop wires, they should be checked. Wire nuts should never be used in loop connections and usually will create these types of issues. If there are splices, they should be soldered if possible or at the very least crimped.
- Failed Loop Wire Insulation – This normally occurs when there is a high moisture content in the air that condenses (rain, fog, or dew) and the loop wire insulation is damaged in some way and this moisture can wick its way to that failure point. Using a megaohm meter on the loop and getting a reading of less than 100 megaohms will usually this type of issue.
- Conductor Fatigue – If the loop is installed across a joint in the driving surface or the lead-in is exposed to significant vibration, the conductor in the wire may fatigue and change its resistance slightly when flexed. With this type of failure, the failed wire must be replaced.
- Objects Embedded in the Saw Slot – It is possible for objects (nails, screws, etc.) to become embedded in the saw slot sealant and over time get pressed down in to the loop wire (especially if good installation practices are not followed). Once this object touches a loop wire conductor, the loop must be replaced.

Loop Reference Changes Score

Score	Meaning	Possible Impact on Gate Operation
7	Very stable reference	None
6	Stable reference	None
5	Edge of normal temperature swing	None
4	Wide temperature swing	Not likely – False detects
3	Edge of effects due to any temperature swing	Not likely – False detects
2	Significant reference movement	Possible false detects
1	Very significant reference movement	Possible false detects
0	Severe reference movement	Possible false detects

Possible causes of loop reference changes:

- Wide Temperature Swings – The reference within the detector will change with temperature. If there are wide temperature swings during a 24-hour period, this score will go down and is expected and normal. The detector is designed to deal with ambient temperature changes of 2°F every minute. Rates of change faster than that may cause false detections (this usually only occurs if the cabinet is opened). If you are in an area that sees quick temperature changes (hot or cold), some insulation around the detectors may help.
- Temperature Sensitivity – It is possible that some of the components on the detector are abnormally temperature sensitive.

How a Vehicle Detector Works

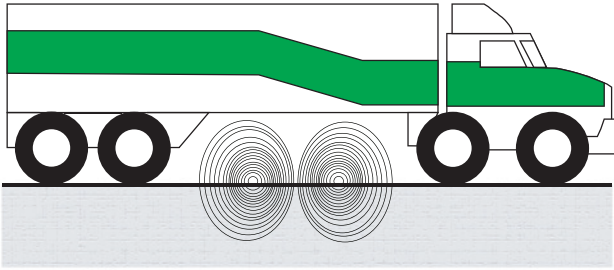

Loop dimension too small unable to detect high bed vehicle

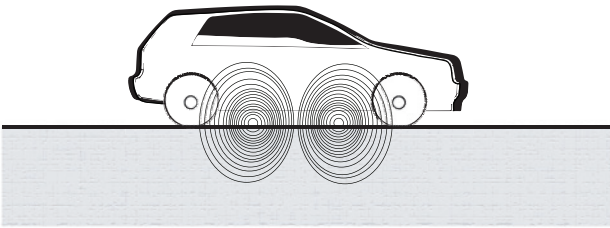

Loop dimension set correctly for the type of vehicle using the site

An inductance field is created when the vehicle detector passes a small amount of alternating current through an in-ground, coiled wire, closed-loop system. A component of the vehicle detector measures the field's frequency. When a vehicle passes over an activated loop, the vehicle detector senses the resultant frequency drop in the inductance field and triggers the vehicle detector to output a command signal.

The usable detection height (H) of the loop's inductance field is two thirds of the distance "X".

NOTE: Any metallic equipment (or item) that conducts electricity and is placed near the vehicle loop will change the frequency of the loop and affect the reading taken by the vehicle detector.

Site Design Considerations:

- Type of vehicular traffic using your site (high bed trucks, passenger vehicles, etc.)
- Proper size and number of vehicle loops (For general passenger vehicle detection, minimum loop size should be 6 x 6 foot (183 x 183 cm.) For truck traffic, minimum loop size is 6 x 8 foot (183 x 244 cm). In parking lot applications, the typical loop size is 2½ x 6 foot.
- Distance between threshold of gate opening and in-ground loop wire is a minimum of 4 feet (122 cm). (The exception to this rule is a Reset Loop used in barrier arm gates and a Shadow Loop commonly used with swing gates.)
- Conduit that runs parallel to a loop must have, at minimum, 1 foot (31 cm) of clearance

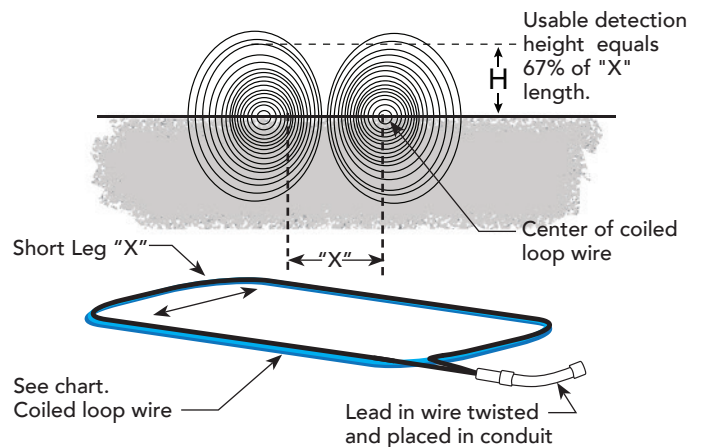

Multiply distance X by 0.67 to determine usable detection height of vehicle loop (inductance field created when loop is active). Direction of loop windings (CW or CCW) determine rotation of inductance field. Maximum loop size is 200 square feet.



CAUTION
Several factors that affect safety must be considered when installing vehicle detector loops. For example, spacing between loops, loop geometry, type of gate, location of gate in respect to the loops, etc. Vehicle detector loops that are sized too small may not sense high bed trucks and, inadvertently, send an "all clear" signal to close the gate which could cause damage to vehicles or injury to persons. If more than one loop is connected to an Hy5B, then the direction in which each loop is wound electrically is critical for safety and proper gate operation. Refer to *Loop Phasing* on page 12.

Loop Wire Installation

When two or more loops are connected to the same vehicle detector, the loops must be the same type (for example, two reversing loops) and *identical in length and width and number of windings*. If loops are not identical, unequal sensitivity for the two loops occurs. Manual sensitivity adjustments are not a viable solution.

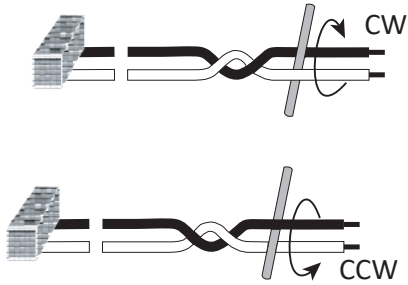

Twist wire cleanly. On Lead In wire, increase windings to 10 twists per foot

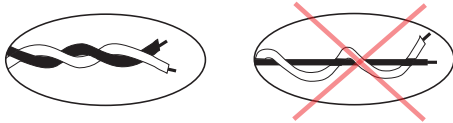

Loop Perimeter	# of Windings
12 feet (2 x 4 Loop)	5 turns
24 feet (6 x 6 Loop)	3 turns
32 feet (6 x 10 Loop)	3 turns
52 feet (6 x 20 Loop)	2 turns

Loop Phasing

The direction of the windings in the loop determine loop phasing.

Phasing Cancellation Effect

A "dead zone" (phasing cancellation effect) between loops occurs when loops are physically located near each other and both loop windings are electrically wound in the same direction (both loops clockwise CW, or both loops counterclockwise CCW).

Creating a "dead zone" may be desirable, when a reversing loop is placed on either side of a sliding gate. The gate can pass between the two loops without tripping the vehicle detector.

Field Enhancement Effect

When two loops are physically located near each other and are wound in electrically opposite directions (CW and CCW), inductance field enhancement occurs.

When the loops are both on the same side of the gate, *field enhancement* may be desirable so dead zones don't occur. For example, when motorcycles are part of your site's standard vehicular traffic, dead zones (where motorcycles travel across undetected) are significantly reduced.

But, on opposite sides of the gate, *field enhancement* may not be a desirable effect. For example, when two loops are placed on either side of a sliding gate, after a vehicle clears the loop, the gate is given a command to close. As the gate closes, it disturbs the inductance field. The vehicle detector senses the change in inductance and logic dictates a command to open. The gate continues this open / close cycle even though no vehicle is present.

REMEMBER!! Always check and test for proper phasing of the loops before leaving your installation site.