



User's Manual

English (US)

Version 1.5a

For use with models:
GS100, GS200, GS300
(2nd Generation)



Do **NOT** return product back to store
(Best Buy, EBay, Amazon, etc.)

Please contact GarageSmart™ Customer Service directly for all matters including returns/exchanges, help with installation (including Wi-Fi configuration), or any questions or comments that you may have.

The information contained herein may be changed at any time without prior notification. This manual nor any parts thereof may not be reproduced for any purpose whatsoever without the express written consent of GarageSmart. All technical specifications, drawings, etc., are subject to copyright law.

© 2017, GarageSmart
All rights reserved.

Table of Contents

Introduction	6
About this User Guide	6
List of nomenclature	6
List of definitions	6
List of icons	6
Precautionary and Safety Information	7
Legal notices	8
Liability	8
Trademarks	8
Customer Service	9
E-mail	9
The GarageSmart™ e-Store	9
Welcome.....	10
Introducing Your GarageSmart™ Device	10
Getting Started.....	11
What's Included.....	11
Optional Parts and Accessories	11
Tools Required for Installation.....	11
Pre-Installation.....	12
Creating a GarageSmart™ Account (Online Control Panel).....	12
Installation	13
Residential Installation.....	13
Mounting the GarageSmart™ Device	13
Mounting and connecting the GarageSmart™ Sensors	14
Custom mounting and connecting the GarageSmart™ Sensors	17
Connecting the GarageSmart™ Device to the Garage Door Motor	17
Commercial Installation	20
Other Installation Applications	21
Wi-Fi Setup.....	22
Configure the GarageSmart™ Device to a secure Wi-Fi network	22
Router Security Configuration	26
Controlling the GarageSmart™ Device	29
The GarageSmart™ App	29
App Installation.....	29
Adding Users, Remote Keys, and Scheduling.....	29
App Setup	30
Controlling Garage Doors using the GarageSmart™ App.....	32
Verify Garage Door Status using the GarageSmart™ App	34

Troubleshooting & Help	35
Finding your default gateway address	35
Most Common Problems	36
Frequently Asked Questions	37
Maintenance	38
Cleaning	38
Adjustments.....	38
Scheduled or Preventative Maintenance	38
Technical Specifications	39

Introduction

About this User Guide

List of nomenclature

PC	Personal Computer
RF	Radio Frequency
ISP	Internet Service Provider
DST	Daylight Savings Time
GSX+	Garage Sense positive inputs (GS1+, GS2+, GS3+)
GSX-	Garage Sense negative inputs (GS1-, GS2-, GS3-)
GDX+	Garage Drive positive outputs (GD1+, GD2+, GD3+)
GDX-	Garage Drive negative outputs (GD1-, GD2-, GD3-)

List of definitions

Port Forwarding	Port forwarding is a feature that forwards inbound traffic from the Internet on a specific port, to reach a single device on your local network.
DHCP reservation	Router assigns a unique, static (fixed) IP address to a specific device on your network.

List of icons



A Video (visual information or tutorial) is available within the specified section of the manual.



Some sections within the manual contain Notes (located at the end of each section), which provides further information pertaining to an item or step within the section. This is shown by one or more numbers at the end of a sentence or paragraph, Example: ⁽¹⁾ ⁽²⁾

Precautionary and Safety Information

- CAUTION:** Internal circuit card components are extremely sensitive to electrostatic discharge. Be careful not to touch internal circuitry prior to discharging any static buildup on yourself. To discharge yourself, touch a grounded metal object such as conductor an earth-grounded metal enclosure.
- CAUTION:** Do not install the GarageSmart™ device outside (except for inside a garage as directed) as this may damage the unit and void its warranty.
- CAUTION:** Do not get the GarageSmart™ device wet or expose to extreme moisture as this may damage the unit and void its warranty.
- CAUTION:** The included AC Power Adapter is provided by a third party and should not be used with any other devices other than the GarageSmart™ device. As many other devices require their own chargers or AC Power Adapters; GarageSmart™ will not be responsible for any damage of any kind that may occur from using the included third party AC Power Adapter.
- CAUTION:** Do not remove the cover or touch inside the GarageSmart™ device with power applied as shock may occur.

Legal notices

Liability

The software, websites, apps and the manual are subject to change without notice. GarageSmart™ is not liable for the accuracy of the information contained in this manual, on its websites, in its apps or for damages resulting from the use of the GarageSmart™ device, this manual, websites or apps.

Trademarks

GarageSmart™ is a trademark of GarageSmart™

 is a trademark of GarageSmart™

All other trademarks mentioned herein are property of their respective companies.

Customer Service

Visit the **GarageSmart™** website, www.garagesmart.net/support.html to view our support page.

On this page you can:

- Reset your account password.
- Find warranty information.
- Send an e-mail to GarageSmart™ customer service.
- Faqs on the most asked questions and answers.

E-mail

To ensure a timely response, use e-mail at www.garagesmart.net/contact.html
Customers will receive a response within a short period of time.

The GarageSmart™ e-Store

If you need accessories or parts for your GarageSmart™ device, please visit the GarageSmart™ web store at www.garagesmart.net/buynow.html

Welcome

Introducing Your GarageSmart™ Device

Welcome to the exciting world of monitoring, opening and closing your garage doors.

With the use of a **GarageSmart™** device, you can reliably monitor, open, close or stop your residential or commercial garage doors anywhere in the world from any flip-phone, smartphone, tablet, PC (basically any device that has internet or text message capabilities) anytime while receiving email and text alerts.

The GarageSmart™ device allows you to grant remote access with the use of a **Master Key** to as many users (staff members, employees, etc.) as needed. Customized individual schedules are also available by providing unique **Remote Keys** that expire when you need them to. The GarageSmart™ device also keeps an accurate log so that you'll always know exactly when and who is opening and closing your garage doors.

The GarageSmart™ device also contains built in Auto Shut features. Set your garage doors to close automatically from 10 minutes up to 2 hours after being left open, or have them close at a pre-determined time of your choosing (for example; every night at 10:00PM for security).

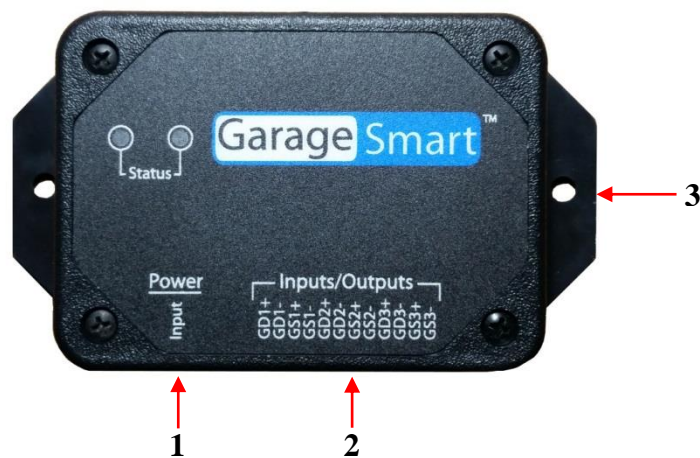

- 1 USB Power Cable input
- 2 Garage Door Drive (outputs) and Sensor (inputs)
- 3 Mounting Flanges

Getting Started

What's Included

Your GarageSmart™ device comes with the following parts or accessories:

- AC Power Supply ⁽¹⁾
- USB Power Cable
- Garage Door Sensor Kit(s) ⁽²⁾
- Welcome and Warranty Letter



1. AC Power Supply may also include a power adapter for certain countries that is determined at the time of order.
2. The number of Garage Door Sensor Kits (shipped with the GarageSmart™ device) is determined at time of order. GS100 includes one (1) sensor kit, GS200 includes two (2) sensor kits, and GS300 includes three (3) sensor kits.
3. If the contents are incomplete, please notify us within 7 days of purchase.

Optional Parts and Accessories

The following parts and accessories are available and can be purchased by contacting GarageSmart™ or through the GarageSmart™ web store:

- Garage Door Sensors
- Hook-up Wire
- Garage Door Sensor Kits
- AC Power Supply's
- USB Power Cables
- Premium Account Upgrade

Tools Required for Installation

The following tools are required for proper installation of the GarageSmart™ device and sensors:

- Ladder or Step Stool high enough to reach garage door tracks, motor or top of door.
- Wire Strippers
- Wire Cutters
- Small Phillips Screw Driver

Pre-Installation

Creating a GarageSmart™ Account (Online Control Panel)

Creating a GarageSmart™ account is required as this provides you with access to an Online Control Panel for setting up individual remote keys, custom schedules, and other configuration settings for controlling your GarageSmart™ device.

1. Visit https://www.garagesmart.net/account_setup.html
2. Enter in all required information on the Account Setup page, including the **Mac Address** and **Device ID** from the back of the GarageSmart™ device ⁽¹⁾.
3. Once a GarageSmart™ account has been created, you will then be able to log into your **Online Control Panel** located at <https://www.garagesmart.net>, by clicking on **MY ACCOUNT** at the top of the page ⁽²⁾.



1. Only one GarageSmart™ Account is required, using a valid Mac Address and Device ID.
2. Multiple GarageSmart™ devices can be added or removed from your account at any time, using the Online Control Panel.

Installation

Residential Installation

Residential installation is for residential garage door motors (typically found in homes), that have a single wall mounted pushbutton that opens and closes the garage door.

Mounting the GarageSmart™ Device

The GarageSmart™ device has a mounting flange that contains two mounting holes. The two mounting holes are centered 3.875" across from each other.

1. Using two of the supplied tie wraps, mount the GarageSmart™ device to the garage door bracket just above the motor as shown below ⁽¹⁾.

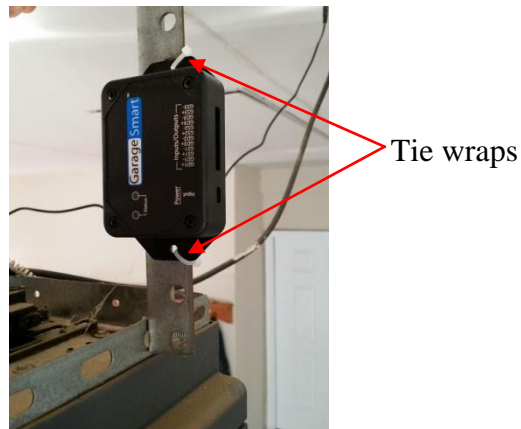

2. Plug the “AC Power Supply” into any 120V outlet (an outlet is usually mounted on the ceiling just above the garage door motor).
3. Plug one end of the “USB Power Cable” into the “AC Power Supply” and the other end into the GarageSmart™ device.



1. For locations that have three (3) garage doors, mount the GarageSmart™ device to the middle garage door bracket (just above the motor) as this will shorten the length of running wires to the other garage door motors and sensors. Otherwise, additional wire will have to be used for proper installation.

Mounting and connecting the GarageSmart™ Sensors

1. Verify that the garage door is fully closed.
2. Apply the supplied double sided tape to the bottom of the sensor (the one without screw terminals) as shown below.



3. Attach the sensor to the side of the garage door (near the top) making sure that the sensor doesn't rub against the wall or interfere with any moving parts when the garage door is opening or closing as shown below ⁽¹⁾.

Top of garage door

Sensor
(without screws terminals)

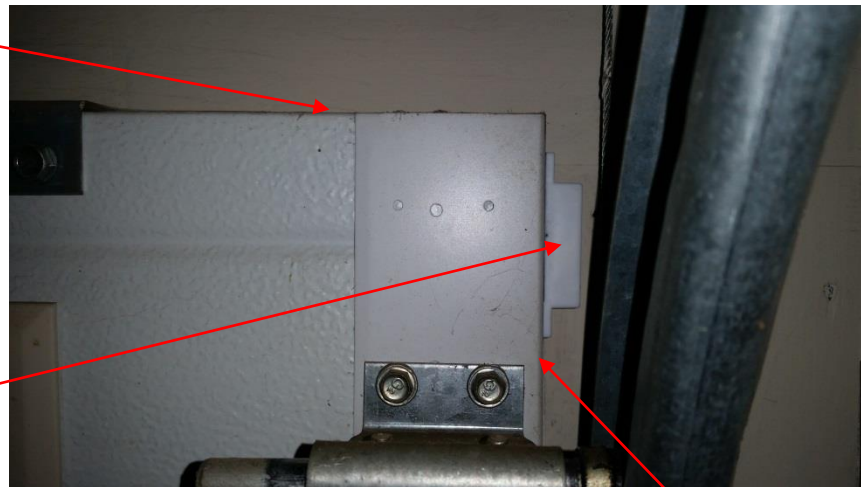

Side of garage door

4. Carefully remove the protective cover from the sensor (with screw terminals) and put to the side.
5. Loosen the screw terminals.

6. Apply the supplied double sided tape to the bottom of the sensor (the one with screw terminals) as shown below.



7. Mount the sensor (with screw terminals) to the wall directly next to the other sensor, making sure that the sensor doesn't interfere with any moving parts when the garage door is opening or closing⁽¹⁾. It is also important that both sensors are aligned with each other and maintain about a 0.25" gap between each other as shown below⁽²⁾.

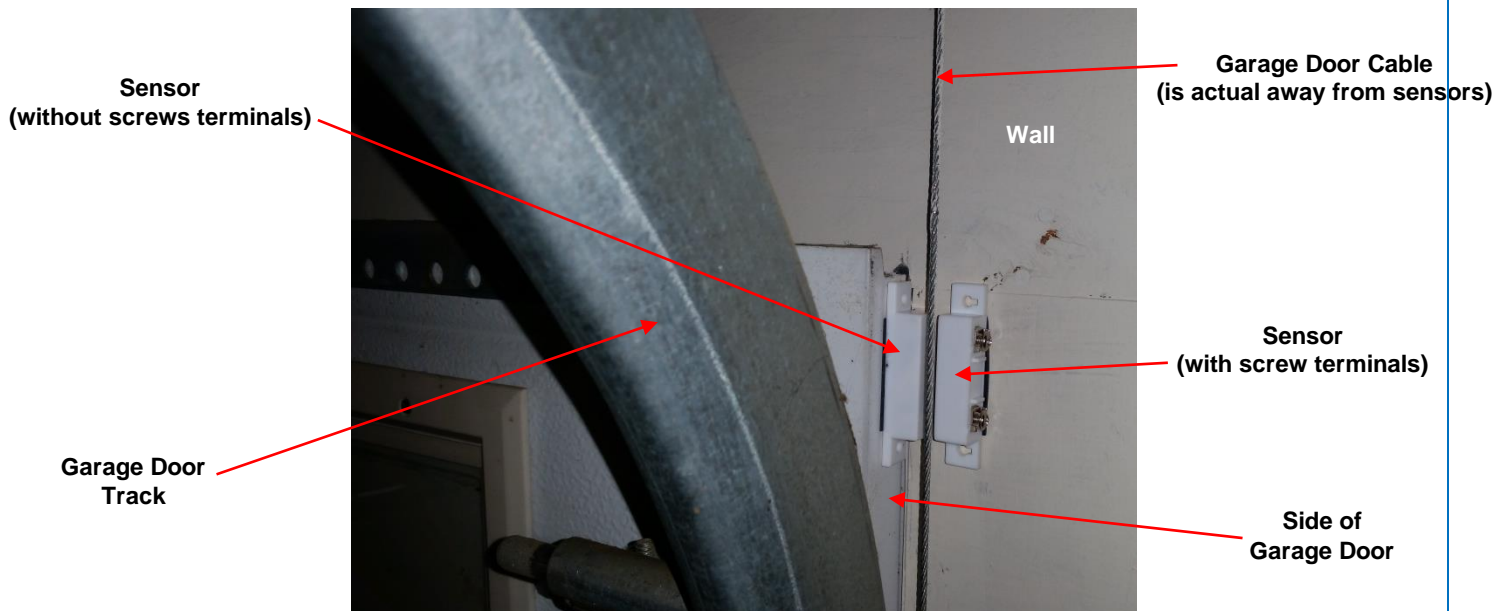

8. Using the supplied hook-up wire, strip both wires on one end about ½ inches.

- Attach and securely screw the wires to the sensor as shown below.

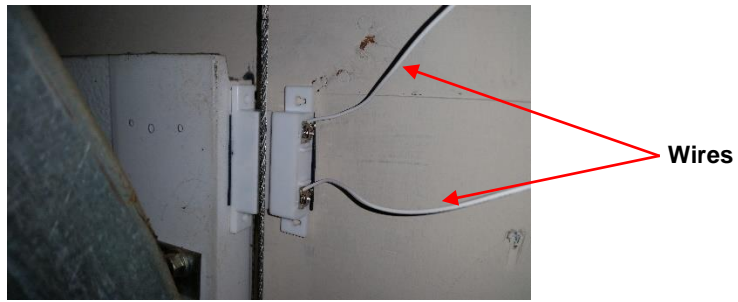

- Carefully put the protective cover back onto the sensor as shown below.

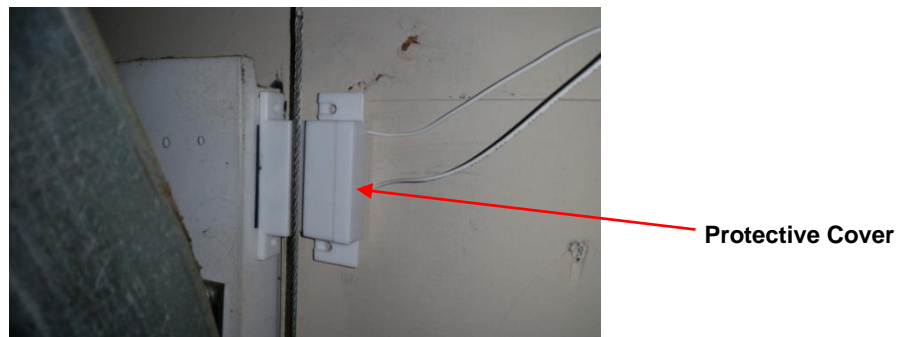

- Run the wire from the sensor to the GarageSmart™ device keeping free of all moving and mechanical parts by using the provided wire holders and tie wraps.
- Cut the wire making sure to leave enough slack to allow for stripping and connection of the wires to the GarageSmart™ device ⁽³⁾.
- Strip both wires about ¼ inches long each.
- First determine what garage door (1, 2 or 3) that the sensor is being installed to. Then using the table below, insert the two wires into the proper (bottom-circular) ports of the GarageSmart™ device. Either wire can be inserted into either the plus (+) or minus (-) port, providing that they are from the same sensor ⁽⁴⁾⁽⁵⁾.

Garage Door	Sensor Ports	Hole Number (from left)
1	“GS1+” and “GS1-“	3 and 4
2	“GS2+” and “GS2-“	7 and 8
3	“GS3+” and “GS3-“	11 and 12

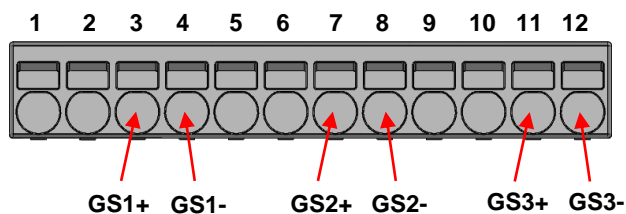

15. For locations that have more than one garage door, repeat the above steps in this section for each garage door (if required).
16. Once all garage door sensors have been fully installed, use the section “Verifying Sensor Alignment” in this manual to test and verify that all sensors have been aligned properly.



1. Failure to keep the sensor and wires free and clear of any moving parts may result in breaking of the sensors or wires.
2. If the sensors are not aligned properly, the GarageSmart™ device will not report the proper Door Status causing false notifications or improper operation.
3. Depending on the location and distance of the GarageSmart™ device to the sensor locations, wire lengths will vary and additional wire may be needed.
4. The plus (+) and minus (-) ports are not polarity sensitive and either wire can be inserted into either port. However, failure to insert wires into the proper GS1x, GS2x or GS3x ports of the GarageSmart™ device pertaining to the same garage door number, will cause false readings, false notifications, and operation or damage may occur to the GarageSmart™ device. For example; for garage door 1, use the GS1+ and GS1- ports.
5. If for any reason a wire needs to be removed, simply insert a small object into the rectangular hole just above the wire to be removed, as this will release the spring that is holding the wire in place.

Custom mounting and connecting the GarageSmart™ Sensors

While GarageSmart™ strives to meet installation for every garage door possible; there may be a need for custom mounting of the sensors due to garage door manufacturer changes in design of the tracks, chains or obstacles.

If necessary, contact GarageSmart™ for assistance and other mounting methods if you find that the above mounting procedures do not fit your garage door application.

Connecting the GarageSmart™ Device to the Garage Door Motor

1. Verify that the garage door is closed.
2. Using the supplied hook-up wire, determine the length between the GarageSmart™ device and the garage door motor. Then cut the wire leaving enough slack to allow for stripping and connection of the wires ⁽¹⁾.
3. Strip both wires on one end about ½ inches long.
4. At the garage door motor, loosen and remove the wires that run to the garage door wall switch as there should be two wires.
5. Using the stripped wires from step 3, twist one wire around each removed wire from step 4 ⁽²⁾.

6. Re-attach the wire to the garage door motor by inserting or screwing in place as show below.

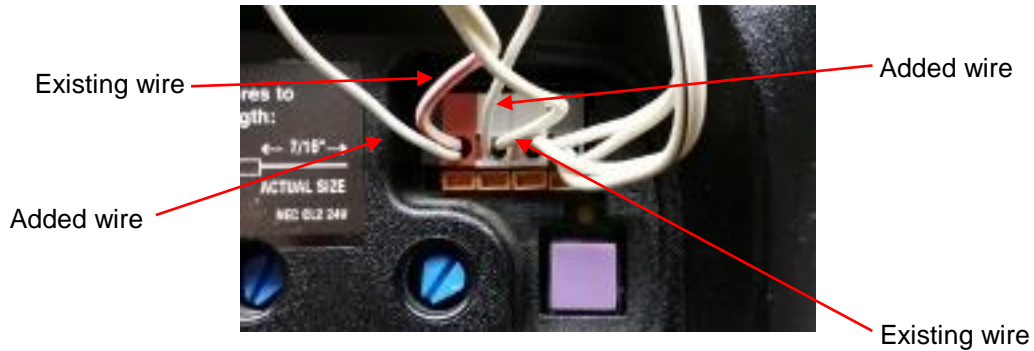

7. Strip the wires on the opposite end about ¼ inches long.
8. First determine what garage door (1, 2 or 3) is being controlled. Then using the table below, insert the two wires into the proper (bottom-circular) ports of the GarageSmart™ device. Either wire can be inserted into either the plus (+) or minus (-) port, providing that they are from the same garage door motor as shown below ⁽³⁾ ⁽⁴⁾.

Garage Door	Drive Ports	Hole Number (from left)
1	“GD1+” and “GD1-“	1 and 2
2	“GD2+” and “GD2-“	5 and 6
3	“GD3+” and “GD3-“	9 and 10

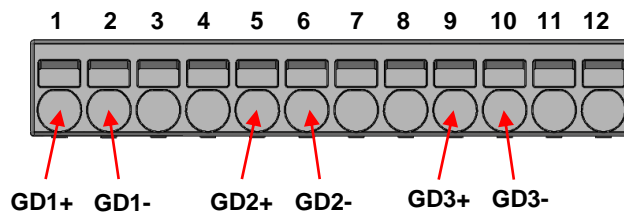

9. If required, for locations that have more than one garage door, repeat the above steps in this section for each garage door.
10. Once all garage door drive connections have been fully installed, use the section “Verifying Garage Door Control” in this manual to test and verify that all garage door drive wires have been installed properly.



1. Depending on the location and distance of the GarageSmart™ device to the garage door motor, wire lengths will vary.
2. Some garage door openers have screw terminals instead of push terminals. If that is the case loosen the screw terminals and attach the wires.

3. The plus (+) and minus (-) ports are not polarity sensitive and either wire can be inserted into either port. However, failure to insert wires into the proper GD1x, GD2x or GD3x ports of the GarageSmart™ pertaining to the same garage door number, will cause the garage doors not to open/close properly and may damage the motor or GarageSmart™ device. For example; for garage door 1, use the GD1+ and GD1- ports.
4. If for any reason a wire needs to be removed, simply insert a small object into the rectangular hole just above the wire to be removed, as this will release the spring that is holding the wire in place.

Commercial Installation

Commercial installation is for commercial garage door motors (typically found in businesses or factories), that have a 3-button wall mounted pushbutton (in which each pushbutton individually opens, closes and stops the garage door).

The GarageSmart™ device is setup the same way as in the Residential Installation (refer to section if necessary), but with the following changes:

1. Mount the GarageSmart™ device near a power outlet (closest to the motor control board).
2. Choose the best and most practical location to install the sensor, making sure that the sensor (without screw terminals) is mounted to the door, and the sensor (with screw terminals) is mounted to a non-moving object (such as a wall or door frame). The sensors must also be mounted in which they are no more than 0.5" apart from each other when the garage door is closed.
3. Connect and insert the sensor wires into the GS1+ and GS1- (bottom-circular) port of the GarageSmart™ device. Either wire can be inserted into either the plus (+) or minus (-) port.

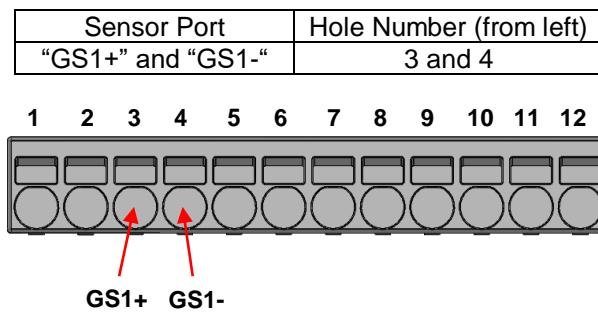

4. Connect the GarageSmart™ drive ports per the below steps (referring to the following diagram if necessary):
 - a. Remove the existing "STOP" wire from the "STOP" terminal of the motor control board, and then connect in parallel to the GD1-, GD2-, and GD3- ports of the GarageSmart™ device.
 - b. Connect the GD1+ port of the GarageSmart™ device to the "OPEN" terminal of the motor control board.
 - c. Connect the GD2+ port of the GarageSmart™ device to the "CLOSE" terminal of the motor control board.
 - d. Connect the GD3+ port of the GarageSmart™ device to the "STOP" terminal of the motor control board.

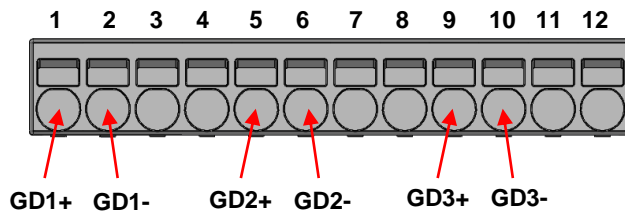
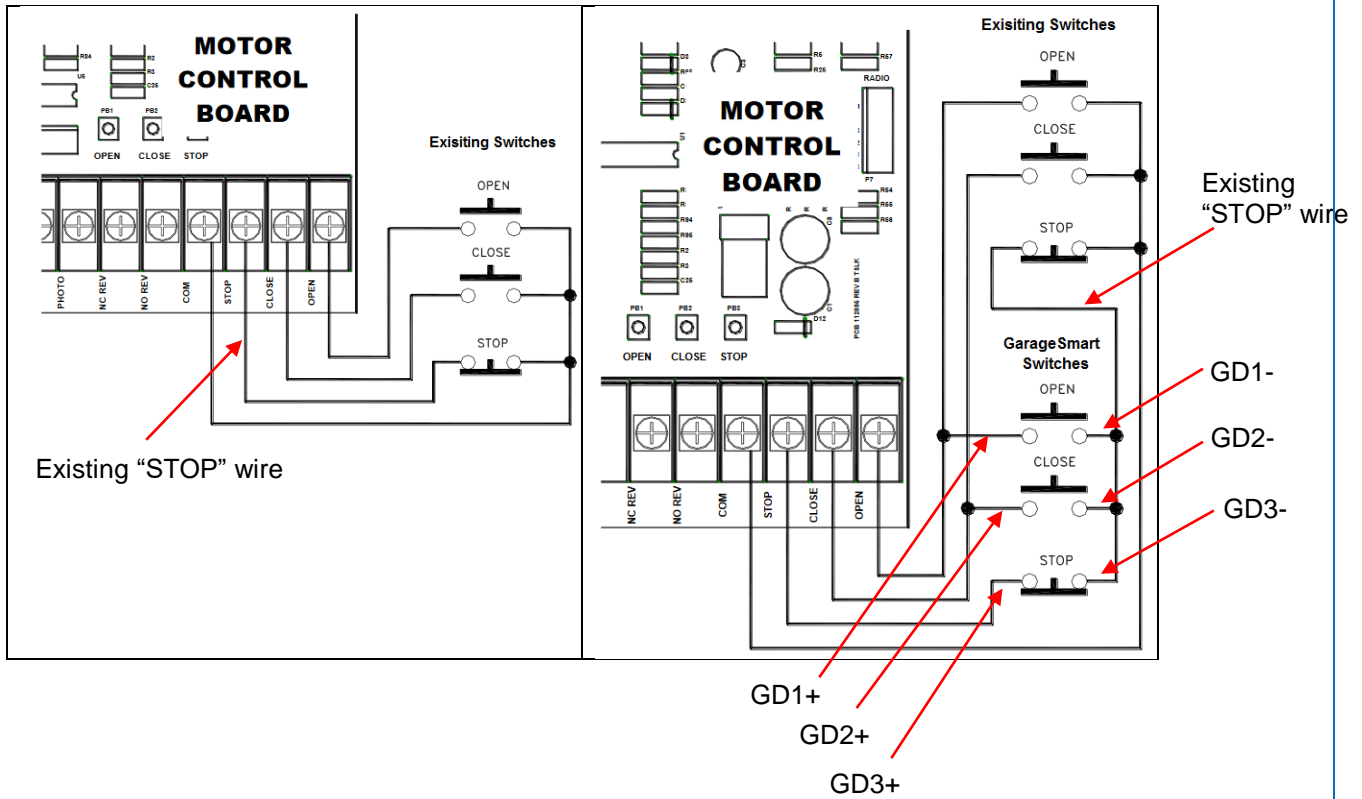

Other Installation Applications

The GarageSmart™ GS100 basically contains (3) internal switches that can be installed into other applications (such as gates, electronic door locks, etc.) that requires control signals to energize or de-energize a circuit.

The wiring convention is straight forward and application dependent.

Switch 1: Pins 1 – 2
 Switch 2: Pins 5 – 6
 Switch 3: Pins 9 – 10

Once installed and operating properly, your application will also be able to customize Remote Keys to control your applications from anywhere.

No matter what your application is, contact GarageSmart™ for assistance with any installation questions, or help that you may need.

Wi-Fi Setup

Configure the GarageSmart™ Device to a secure Wi-Fi network

The GarageSmart™ device can be connected to a secured Wi-Fi network using a “Static IP” or “DHCP”. ⁽¹⁾ ⁽²⁾

When initially powered up, the GarageSmart™ device will become a Wi-Fi Access Point for device configuration purposes and will broadcast its unique SSID in the form of GarageSmart_80_xxxx. ⁽³⁾

For security reasons, the GarageSmart™ device will stop broadcasting its unique SSID after a short period of time. The GarageSmart™ Wi-Fi Access Point can be re-enabled by removing and then applying power to the GarageSmart™ device.

1. Apply power to the GarageSmart™ device.
2. Using any Wi-Fi enabled device (such as a cellphone, tablet, computer, etc.), search and connect to the “**GarageSmart_80_XXXX**” Wi-Fi network. ⁽³⁾
3. When prompt for a password, enter the complete Mac Address of the GarageSmart™ device (no spaces and lowercase letters only). ⁽⁴⁾
4. Once connected to the GarageSmart Wi-Fi network, open any web browser and type in the following address: <http://192.168.4.1/wifisetup> as the following screen should be shown below; otherwise see note ⁽⁵⁾ below.

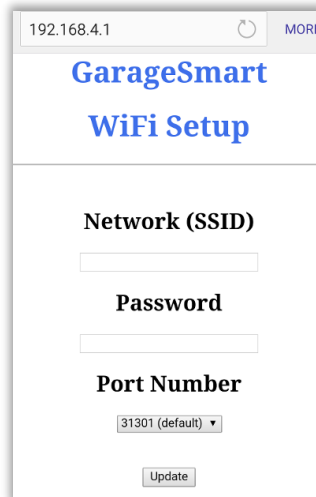

The screenshot shows a mobile web browser interface for the GarageSmart WiFi Setup. At the top, the address bar shows '192.168.4.1' and a 'MORE' option. The main heading is 'GarageSmart WiFi Setup'. Below this, there are three sections for configuration: 'Network (SSID)' with an empty text input field, 'Password' with an empty text input field, and 'Port Number' with a dropdown menu set to '31301 (default)'. At the bottom of the form is an 'Update' button.

5. Enter the Network Name (SSID) and Password of your Wi-Fi network.
6. Select the **Port** from the dropdown menu (if shown), that your router will use to talk to the GarageSmart™ device. Use the default port “**31301**” if this is the only

GarageSmart™ device that will be configured on your routers Wi-Fi network; otherwise see note ⁽⁶⁾ below.

7. Click “Update”.
8. Within a few seconds the Status LED of the GarageSmart™ device will alternate between **RED** and **GREEN** a few times, signaling the start of the Wi-Fi update process. If not, use your browsers back button and repeat steps 5, 6, 7 and 8 above to resend the update.

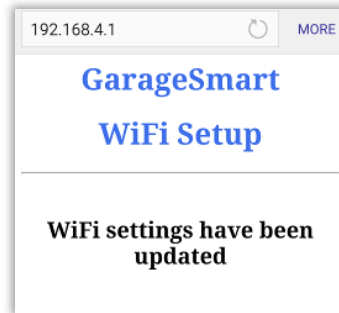

9. The Status LED will then remain **RED** for at least 5 seconds while the GarageSmart™ device goes through a reboot process.

10. The Status LED will eventually blink a specific color and pattern. Using the table below, determine the Result and Solution to perform (if necessary).

Status Led Color	Number of Blinks	Result	Solution
RED	Solid	Reboot started.	Wait a few seconds for reboot process to start. ⁽⁷⁾
RED	1	Wi-Fi disconnected or wrong password.	Repeat this procedure verifying that the Network Name (SSID) and password is correct.
RED	2	Searching for Wi-Fi network.	Repeat this procedure verifying that the Network Name (SSID) is correct.
RED	3	Error Occurred	Repeat this procedure verifying that the Network Name (SSID) and password is correct.
AMBER	1	GarageSmart™ device is connected to the router; however, the internet connection has been lost.	Verify and restore internet connection. ⁽⁸⁾
AMBER	2	GarageSmart™ device is connected to the router. However, the Device ID is invalid on the GarageSmart™ network.	Contact GarageSmart for assistance.
AMBER	3	GarageSmart™ device is connected to the router. However, Router Security Configuration (Port Forwarding) has not been set up on the router.	Perform the section called, “ Router Security Configuration ” in the below sections.
GREEN	1	The GarageSmart™ device has successfully connected to the router and is fully online.	If not done so yet, the GarageSmart™ device is ready for installation. See Installation sections below.
GREEN	Solid	The GarageSmart™ device is downloading new firmware.	Wait for the download to finish as the device will eventually reboot.



1. The router must be 802.11b, 802.11g, 802.11n, or 802.11ac (2.4 GHz) compatible. The 2.4 GHz Wi-Fi network must be used as the GarageSmart™ device will **NOT** work on 5 GHz Wi-Fi networks.
2. For international countries, plug the “AC Power Supply” into a power adapter. Then plug the power adapter into any power outlet.

- The "GarageSmart" Wi-Fi Network name (SSID) may contain extra characters at the end of the SSID. Whereas the first group (5 numbers) represents the **Port** that the GarageSmart™ device is currently assigned to and last group (4 letters or numbers) represents the last four characters of the GarageSmart™ devices Mac Address.

For example; "GarageSmart_31301_bc78" specifies that the GarageSmart™ device is currently assigned to port "31301" and the last four characters of the GarageSmart™ devices Mac Address is "bc78".

Each GarageSmart™ device will have its own unique GarageSmart™ Wi-Fi Network name (SSID).

- The Mac Address can be found by looking at the back of the GarageSmart™ device or within the users online control panel by logging into "My Account". The Mac Address is twelve (12) characters long, with each character being either a number "0" thru "9" or a lowercase letter "a" thru "f".
- If the GarageSmart Wi-Fi Setup screen does not appear after a few attempts, then first determine which GarageSmart Wi-Fi Network (SSID) that your Wi-Fi enabled device is connected to. Then using the table below, use the corresponding Web Address to connect to the GarageSmart™ device, as the device may be configured to a different port.

GarageSmart Wi-Fi Network (SSID)	Web Address
GarageSmart_80_XXXX	http://192.168.4.1/wifisetup or http://192.168.4.1:80/wifisetup
GarageSmart_31301_XXXX	http://192.168.4.1:31301/wifisetup
GarageSmart_31302_XXXX	http://192.168.4.1:31302/wifisetup
GarageSmart_31303_XXXX	http://192.168.4.1:31303/wifisetup
GarageSmart_31304_XXXX	http://192.168.4.1:31304/wifisetup
GarageSmart_31305_XXXX	http://192.168.4.1:31305/wifisetup
GarageSmart_31306_XXXX	http://192.168.4.1:31306/wifisetup
GarageSmart_31307_XXXX	http://192.168.4.1:31307/wifisetup
GarageSmart_31308_XXXX	http://192.168.4.1:31308/wifisetup
GarageSmart_31309_XXXX	http://192.168.4.1:31309/wifisetup
GarageSmart_31310_XXXX	http://192.168.4.1:31310/wifisetup

- If more than one GarageSmart device is being connected to the same Wi-Fi router, then use the table below to determine what port to select for each GarageSmart device, to avoid conflicts between devices:

GarageSmart Device	Port (to use)
1	31301 (default)
2	31302
3	31303
4	31304
5	31305
6	31306
7	31307
8	31308
9	31309
10	31310

- During the reboot process, the Status LED of the GarageSmart™ device may blink different colors or patterns at different times. The reboot process is complete when the color of the Status LED and the number of blinks no longer changes.
- The router must have an active internet connection in order for the GarageSmart™ to be able to communicate with the GarageSmart™ network. Restore the routers internet connections or consult with your local Internet Service Provider if service continues not to be available.

Router Security Configuration

For the GarageSmart™ device to receive inbound commands (red arrows below) from the Internet and the GarageSmart™ Network, **Port Forwarding** must be setup properly within the router.

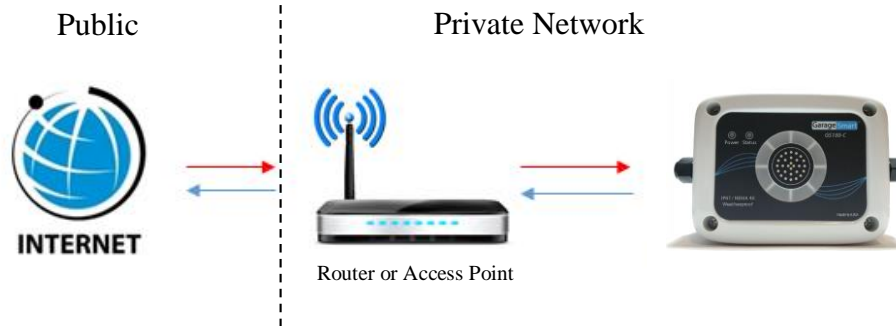

1. Apply power to the GarageSmart™ device.
2. After a few seconds, verify that the Status LED is blinking **AMBER** 3 times (3x) repeating.
3. Using any Wi-Fi enabled device (such as a cellphone, tablet, computer, etc.), search and connect to the "**GarageSmart_31301_XXXX**" Wi-Fi network. ⁽¹⁾
4. For DHCP Mode (or to verify that the router has assigned an IP Address), once connected, open any web browser and type in the default address: <http://192.168.4.1:31301/ip> as the following screen should be shown below; otherwise see note ⁽²⁾ below.

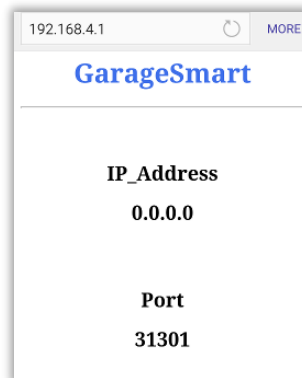

5. Write down the **IP Address** that the Wi-Fi router has assigned to the GarageSmart™ device and the **Port** number that the GarageSmart™ device is currently using, as they will be needed in the following steps.

6. Login into your router as this is usually accomplished by typing the Gateway Address into your web browser. ⁽³⁾ ⁽⁴⁾

If you don't know the default **Gateway Address** of your router, see [Finding your default gateway address](#) in the **Troubleshooting & Help** section of this manual.

7. Under your routers **Port Forwarding** settings, add the following information: ⁽⁵⁾

- a. **IP Address:** Select an available IP Address or the IP Address that was shown in Step 4 above.

- b. **Start Port:** Select **31301** as the Start Port.

Each GarageSmart™ device requires a different **Port** when used on the same network. Example: 31301 for the first device, 31302 for the second device, 31303 for the third device, etc.

- c. **End Port:** This is the same as **Start Port** above. ⁽⁶⁾

- d. **External IP Address:** If your router has this setting, set this to 0.0.0.0

- e. **Protocol:** TCP

- f. **Description, Application Name, or Device Name:** GarageSmart ⁽⁷⁾

Forwarding Rules Added	
Local IP Address	192.168.0.202
Start Port	31302
End Port	31302
External (Internet) IP Address	0.0.0.0
Start Port	31302
End Port	31302
Protocol	TCP
Description	GS100-C
Enable/Disable	Enable
<input type="button" value="Edit"/> <input type="button" value="Clear"/>	

Example

8. Save changes to the router.
9. Remove power from the GarageSmart™ device for a few seconds, and then reapply power.
10. After a few seconds, the Status LED should be blinking **GREEN**. If so, then Port Forwarding has been successfully configured within the router and the GarageSmart™ device is fully online.



1. The “GarageSmart” Wi-Fi Network name (SSID) may contain extra characters at the end of the SSID. Whereas the first group (5 numbers) represents the **Port** that the GarageSmart™ device is currently assigned to and last group (4 letters or numbers) represents the last four characters of the GarageSmart™ devices Mac Address.

For example; “GarageSmart_31301_bc78” specifies that the GarageSmart™ device is currently assigned to port “31301” and the last four characters of the GarageSmart™ devices Mac Address is “bc78”.

Each GarageSmart™ device will have its own unique GarageSmart™ Wi-Fi Network name (SSID).

2. If the GarageSmart screen does not appear after a few attempts, then first determine which GarageSmart Wi-Fi Network (SSID) that your Wi-Fi enabled device is connected to. Then using the table below, use the corresponding Web Address to connect to the GarageSmart™ device, as the device may be configured to a different port.

GarageSmart Wi-Fi Network (SSID)	Web Address
GarageSmart_31301_XXXX	http://192.168.4.1:31301/ip
GarageSmart_31302_XXXX	http://192.168.4.1:31302/ip
GarageSmart_31303_XXXX	http://192.168.4.1:31303/ip
GarageSmart_31304_XXXX	http://192.168.4.1:31304/ip
GarageSmart_31305_XXXX	http://192.168.4.1:31305/ip
GarageSmart_31306_XXXX	http://192.168.4.1:31306/ip
GarageSmart_31307_XXXX	http://192.168.4.1:31307/ip
GarageSmart_31308_XXXX	http://192.168.4.1:31308/ip
GarageSmart_31309_XXXX	http://192.168.4.1:31309/ip
GarageSmart_31310_XXXX	http://192.168.4.1:31310/ip
---	---

3. Every routers login, DHCP Reservation and Port Forwarding process is different from one another. If you do NOT have access or know how to login into your router, enable DHCP reservation, assign a static (fixed) IP Address (if needed), or add Port Forwarding to your router, then refer to your routers manual or **contact your Internet Service Provider (ISP)** as they will be able to assist you on making the required changes to your router easily.
4. For more information on port forwarding or a list of the most common type’s routers, visit www.portforward.com/routers.htm and www.setuprouter.com
5. Regardless of what brand the router is or what software is on the router, the same type of information will be entered (a text field where you can type in the name of the application or service, which incoming port number the router should watch for, and which protocol to use).
6. Set the Port Forward range (or Start and End Ports) the same.
Example: If the GarageSmart device has been configured to use Port 31301, then set the Start Port and End Port to 31301 also.
7. The “Application Name” can be named anything that you choose, such as; GarageSmart, GarageSmart2, etc.

Controlling the GarageSmart™ Device

The GarageSmart™ GS100-CR device can **Open**, **Close** or **Stop** your garage door from anywhere using any smartphone, pc/laptop, tablet or any other device that has a connection to the internet.

The GarageSmart™ App

GarageSmart™ provides a user-friendly app that allows users to Open, Close, Stop or Monitor multiple GarageSmart™ devices from any Android or Apple smartphone or tablet.

App Installation

1. Visit Google Play or the App Store and search for **GarageSmart**, or scan the associated QR code below.



Google Play



App Store

2. Download and install the GarageSmart™ app onto your smartphone or tablet.

Note: A Windows version is also available on request.

Adding Users, Remote Keys, and Scheduling

Before a **User** can start to control and monitor a GarageSmart™ device, the **User**, a **Remote Key**, and **Schedule** for that **User** must be added to your account, all of which can be achieved by using the **Online Control Panel**.

An **Installer Mode** feature is also available within the **Online Control Panel Manual** that allows a professional installer to fully test the installation and use of the GarageSmart™ App to control the doors, by having the **Access Code**, **User** and **Remote Key** sent to their email address.

If needed, see the **Quick Start** section within the **Online Control Panel Manual**. This can be found by logging into the **Online Control Panel**, then clicking on **Help**. There you will find step-by-step instructions as well as a tutorial video on how to add **Users**, **Remote Keys**, and custom **Schedules** to your account.

If an **Online Control Panel** account has not been setup previously, then see the section [Creating a GarageSmart™ Account \(Online Control Panel\)](#) above, to create an account before performing the **App Setup** section below.

App Setup

Because the GarageSmart™ app is designed to be used in both Residential and Commercial use, there are two modes that the GarageSmart™ app can run in, **Classic** mode or **Advanced** mode.

This section will show how to setup the GarageSmart™ app in **Classic** mode, using a **Device ID** and **Remote Key**. The app must be in **Classic** mode when using the GarageSmart device to control residential doors.

Further information on the differences between **Classic** and **Advanced** can be found within the **Online Control Panel Manual**, that can be found by logging into your **Online Control Panel**, then clicking on **Help**.

1. Find and run the GarageSmart™ app that is installed on your device.
2. The **App Settings** page will automatically be shown; the first time the app is opened (after installation). If not, from the main screen of the GarageSmart™ App, click the **Settings** icon, then **App Settings**.

Set **App Mode** to **Classic** and make any other changes as necessary.

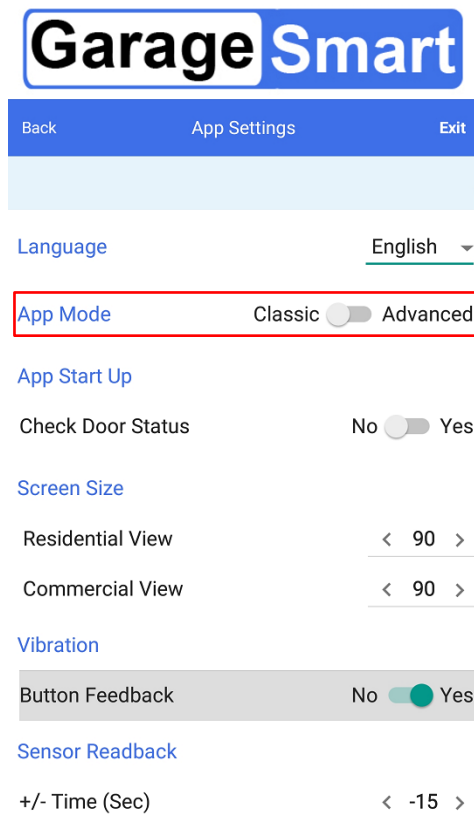

Function	Options	Description
Language	English	Displays all text in English
	French	Displays all text in French
	Spanish	Displays all text in Spanish
App Mode	Classic	Displays each Residential or Commercial device on a separate page. Must set to Classic if any Residential devices are installed.
	Advanced	Displays all devices on a single page for easier viewing and door selection. This mode only works for Commercial devices and is recommend if multiple Commercial devices are being installed.
App Start Up	Check Door Status	Automatically checks the status of the doors (for the current selected device) every time the app opens (restarts). This feature is only available when App Mode is set to Classic .
Screen Size	Residential View	Changes the size of the residential Open/Close images on the main page.
	Commercial View	Changes the size of the commercial Open/Close/Stop images on the main page.
Vibration	Sensor Feedback	Determines whether the smartphone shall vibrate or not when controlling doors.
Sensor Readback	Additional Time (Sec)	Default is set to "0". Incrementing this value increases the time it takes for the sensor to provide door status (for slower moving doors). Decrementing this value decreases the time it takes for the sensor to provide door status (for faster moving doors).

3. Click **Exit**.
4. From the main screen of the GarageSmart™ App, click the **Settings** icon, then **Device Settings**.

5. Enter a **Device Name** (this can be anything such as Home, Work, etc.)
6. Enter the **Device ID**.⁽¹⁾
7. Enter the **Remote Key**.⁽¹⁾
8. Click **Save Device**, a message will appear **Device has been saved**.⁽²⁾
9. Click the **Exit** button within the app.

Controlling Garage Doors using the GarageSmart™ App

The GarageSmart™ app has the capability of controlling either one door at a time, or multiple doors.

Control and Monitoring Garage Doors:

1. Checking the Status of the Garage Doors:
 - At any time, click the refresh icon to check and verify the status of the all garage doors that pertain to the device that is currently selected. The status of each door will be visible by a small **GREEN** or small **RED** circle next to the door number at the bottom.
2. Opening a garage door that is currently closed:
 - Select the Garage Door number at the bottom of the screen that needs to be opened (indicated by a small **GREEN** circle next to the door number).
 - Press and hold the Closed Garage Door symbol (indicated by a **GREEN** glowing ring) until the door starts to open.
 - The app will then eventually show the real-time status of each garage door.
3. Closing a garage door that is currently open:
 - Select the Garage Door number at the bottom of the screen that needs to be closed (indicated by a small **RED** circle next to the door number).
 - Press and hold the Opened Garage Door symbol (indicated by a **RED** glowing ring) until the door starts to close.
 - The app will then eventually show the real-time status of each of each garage door.

4. Closing multiple garage doors that are currently open:

- Press and hold, **Hold here to close all garage doors** (indicated by a blue box at the bottom of the screen) until the doors start to close ⁽⁴⁾.



1. Device information will not be saved if the user does not click on "Save Device" before changing screens or exiting out of settings.
2. Remote keys are assigned within the control panel of your account. Please see the "Online Control Panel Guide" for more information on creating or changing Remote Keys for your GarageSmart™ device.
3. If no selection is made for a garage door, then the current state of the garage door will remain.
4. The blue box at the bottom of the screen will only show if two or more garage doors are open and if the garage door controls are visible for those doors.

Verify Garage Door Status using the GarageSmart™ App

Monitoring the Garage Doors requires that the GarageSmart™ App has already been installed and setup properly.

1. At any time, click the refresh icon  to check and verify the status of the garage door that pertains to the device that is currently selected.

The status of current selected door will be visible by a **GREEN** or **RED** halo around the Garage Door button.



A **GREEN** halo around the Garage Door button means that everything is **Secured** and the door is closed.

A **RED** halo around the Garage Door button means **Caution** and that the door is open.

Also the **GREEN** or **RED** circles located at the bottom, next to each door indicates the status of each door.

Troubleshooting & Help

The GarageSmart™ device is completely tested at the factory before being packaged and shipped. If installed properly and in accordance with the installation instructions in this manual, your GarageSmart™ devices should provide many years of trouble free service. If the device should not function or you need help, the following guides will assist in troubleshooting.

Finding your default gateway address

On most home and small business networks, where you have a single router and several connected devices, the router's private **IP Address** is the default **Gateway Address**. All devices on your network send traffic to that **IP Address** by default.

The default **Gateway Address** of your router can be found using one of the following methods:

On the Router:

- i. Look for the **Gateway Address** at the back or bottom of your router.

On Windows:

- ii. Search and run the command **CMD**
- iii. Type **ipconfig**, then enter.
- iv. Look for **Default Gateway**.

On Mac:

- v. Go to **System Preferences**.
- vi. Select **Network**.
- vii. Select **Advanced**.
- viii. Click the **TCP/IP** tab.
- ix. Your router's gateway will appear next to **Router**.

On iOS:

- x. Go to **Settings**.
- xi. Tap **Wi-Fi**.
- xii. Tap your current active Wi-Fi network.
- xiii. Your default gateway's IP address will appear next to **Router**.

On Android:

- xiv. Go to **Settings**.
- xv. Tap **Wi-Fi** (Note: on Samsung devices, first tap **Connections**, then tap **Wi-Fi**).
- xvi. Tap your current active Wi-Fi network.
- xvii. Tap **Advanced**.
- xviii. Your default gateway's IP address will appear under **Gateway**. (Note: on Samsung devices, for **IP Settings**, select **Static** to view the Gateway Address).

Most Common Problems

Below is a compiled list of the Most Common problems that can occur. Before contacting GarageSmart™ for support, please review the list as one of the solutions may correct the issue that you may be experiencing.

Problem	Solutions
<ul style="list-style-type: none">Garage door(s) are not opening or closing when using individual Remote Keys through the website, mobile site or app.	<ul style="list-style-type: none">Check and verify that the GarageSmart™ device has power by checking if the Status LED is blinking Green.Verify that you have entered the correct Device ID and Remote Key.The Remote Key has not expired. This information can be checked by logging into your Online Control Panel.Check for any broken or detach wires (GD1 +/-, GD2 +/-, or GD3 +/-) between the GarageSmart™ device and the garage door motor.
<ul style="list-style-type: none">The website, mobile site or app is showing the wrong status or always shows Open for my garage door(s).	<ul style="list-style-type: none">Visual inspect the GarageSmart™ sensor for any broken wires and make sure that the two sensors are aligned properly when the door is closed.
<ul style="list-style-type: none">The Auto Shut feature is closing my garage door(s) at the wrong time.	<ul style="list-style-type: none">Verify within the Online Control Panel that you have the correct location settings. ⁽¹⁾
<ul style="list-style-type: none">When closing the garage door(s), the garage door(s) open again.	<ul style="list-style-type: none">Verify that there are no obstacles in the way or blocking your garage door floor sensors.

Still having problems? If assistance is needed after performing the above troubleshooting procedures, do not remove or return the unit and contact GarageSmart™ for support.

We will assist you in troubleshooting the device or the installation to get the unit to operate correctly.

You may also contact GarageSmart™ using e-mail at www.garagesmart.net/contact.html



1. Selecting the wrong Time Zone will affect real-time operation, notification and logging.

Frequently Asked Questions

Question	Answers
Can I monitor all garage doors?	Yes, GarageSmart™ device will show the real live status (Closed or Open) for each garage.
Can GarageSmart™ close my garage door(s) automatically?	Yes, the GarageSmart™ adds Auto Shut features that allow you to set your garage doors to close automatically from 10 minutes up to 2 hours after being left open, or have them close at a pre-determined time of your choosing (for example; every night at 10:00PM for security).
Is the GarageSmart™ protected under any warranty?	Yes, all GarageSmart™ devices have a standard (1) year “limited warranty” that starts from the product ship date (excluding external parts and accessories). However, the warranty can be upgraded to a longer term.
How do I add a Device, User or Remote Keys to my account for controlling the GarageSmart™ device?	Log into your Online Control Panel to make changes to your account. There you can find manuals and videos under Help .

Maintenance

Cleaning

No cleaning methods or procedures are required.

Adjustments

No direct hands on or field adjustments are required for the GarageSmart™ device.

Scheduled or Preventative Maintenance

No preventative or scheduled maintenance is required.

Technical Specifications

GarageSmart™ Device

Input Voltage: 5VDC
Input Current: 5mA (Normal Operation), 200mA (during worse-case TX events)

Temperature Range: -20 degrees C to +55 degrees C
Relative Humidity Range: 0 - 95% Non-Condensing

Wi-Fi Radio 802.11 b/g/n/ac (2.4 GHz)
TX Power 802.11b +20 dBm
802.11g +17 dBm
802.11n +14 dBm

Operation Wi-Fi Range Typical Ranges*
802.11b 115 feet indoors, 460 feet outdoors
802.11g 115 feet indoors, 460 feet outdoors
802.11n 230 feet indoors, 820 feet outdoors

* Typical ranges are dependent on the user's router transmission power, antenna type, the location, and the environment. Ranges have been reported to be longer than the Typical Ranges shown above.

Radio Certification FCC, CE, TELEC, SRRC