

ENFORCER®

E-936-S45RRGQ

Retro-Reflective Photoelectric Beam Sensor

Manual



Intertek
Conforms to UL325-2016



Features:

- Range 45 ft (14m)
- Weatherproof (IP66) construction for indoor/outdoor usage
- Pre-wired 6-foot cord
- Bracket and mounting hardware included for both sensor and reflector
- Adjustable sensing range
- Compact size

Typical Applications:

- Sensor for garage doors or outdoor gates
- Entry detection for store fronts
- Assist in measuring parking distance
- Light on type

IMPORTANT: The E-936-S45RRGQ conforms to UL325-2016 for gate operators that use the N.C. or 10kΩ resistor for monitoring.

Caution:

- This sensor was not designed to prevent bodily injury or loss of life.
- This sensor was not designed for use in environments where explosive gasses may be present.
- Use of this sensor in certain security applications may be regulated by local laws or codes. SECO-LARM is not responsible for compliance with such laws or codes.

ENFORCER Retro-Reflective Photoelectric Beam Sensor

Parts List:

1x Transmitter/Receiver	1x Round reflector	1x Adjustment screwdriver
1x $1\frac{3}{16}$ " Phillips/slotted wood screw	1x Plastic wall anchor	4x $1\frac{3}{16}$ " Phillips wood screws
4x $1\frac{3}{4}$ " Phillips machine screws	2x Hex nuts	2x $1\frac{1}{4}$ " Phillips/slotted machine screws
1x $\frac{5}{8}$ " Phillips/slotted machine screw		1x Reflector hood for round/square reflector
1x Sensor mounting bracket E-931ACC-BLS5Q		1x Sensor mounting bracket E-931ACC-BLS1Q

Specifications:

Type	Retro-reflective	
Sensing range	0.5~45 ft (0.2~14 m)	
Operating voltage	12-30V DC/AC 60Hz, 100mA	
Current draw	Standby	70mA@12VDC
	Active	55mA@12VDC
Response time	10ms	
Light source	IR LED	
LED indicators	Yellow LED (Alignment), Red LED (Power on)	
Trigger output	SPDT Relay output (NO/NC/COM, with built-in 10KΩ resistor on N.O. output)	
Switching capacity	2A@30VAC/VDC	
Enclosure	IP 66 Weatherproof	
Operating temperature	-4~131°F (-20~55°C)	
Mounting brackets for sensor and reflector	Included	

Sample Installations:

Parking Distance Monitor

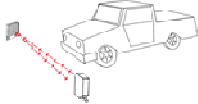

Main Entrance Door

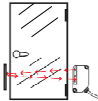

Garage Door

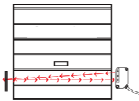

Entry Gate

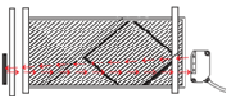

Store Entrance

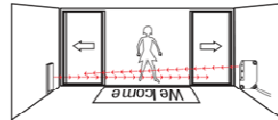

Dimensions:

Reflector

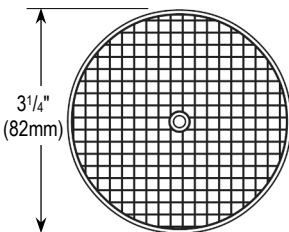

Transmitter/Receiver

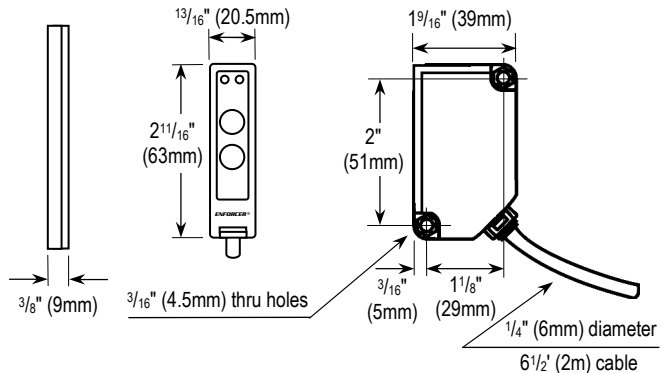

Installation and Adjustment:

LED Functions:

- Red LED – When ON, indicates the sensor is powered.
- Yellow LED – When ON, indicates the sensor is properly aligned with the reflector, and the sensor is not triggered.

Fig. 1

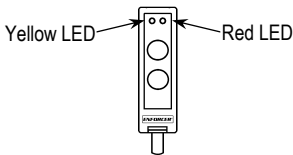

Sensing Range Adjustment Functions:

The Sensing Range adjustment knob sets how powerful the infrared signal emitted by the sensor is.

- Min. Setting – The infrared power signal emitted by the sensor is at its minimum or weakest.
- Max. Setting – The infrared power signal emitted by the sensor is at its maximum or strongest.

The objective of this function is to set the appropriate power of the infrared signal corresponding to the distance between the sensor and the reflector of a particular application. The factory default setting is set at "Max."

Note: If the infrared signal is too strong, the sensor may not trigger. If the infrared signal is too weak, the sensor may be susceptible to false alarms.

Installation:

1. Mount the reflector and the sensor so they face each other (see pg. 4, "Mounting the Sensor").
2. Connect power to the sensor (see pg. 4, "Wiring"). The red LED will turn ON indicating that the sensor is powered on. If the yellow LED is ON, it indicates that the sensor and reflector are aligned (although it still may be necessary to slightly adjust the alignment).
3. Turn the sensing range knob to Max.
4. To find the correct alignment, slowly adjust the angles of the sensor (and/or reflector) up, down, left or right.

Note: Correct alignment is reached when the yellow LED turns ON.

Note: If adjusting the sensor will not turn the yellow LED on, the sensor is at the edge of sensing the signal, and may not work properly.

Adjusting the Sensing Range:

After the sensor and the reflector have been properly installed, the next step is to adjust the appropriate setting for the sensing range.

1. Open the top cover of the sensor as shown in Fig. 2.
2. Peel back the tape covering the sensitivity adjustment access holes, taking care not to soil the tape so that it can be easily reapplied.

3. Starting from the Max. position, slowly turn the knob counter-clockwise until the yellow LED turns OFF. This position represents the weakest point of the infrared signal for this particular application. The setting of the sensing range must be a little higher than this point, so turn the knob clockwise to have a little distance from the weakest point. The ideal setting is midpoint between the weakest point and Max. Close the top cover securely to prevent water from entering the sensor.

4. Place the tape back over the sensitivity adjustment access holes and snap the cover back into place, ensuring that the cover is firmly seated.

Note: When turning the knob counter-clockwise from the Max. position, if the weak point is near the Max. position, the knob should be set at Max.

Note: Ensure that the tape is properly reapplied over the sensitivity adjustment access holes, so that water will not enter and cause damage.

Testing:

1. Power up the sensor. Both LEDs should be ON.
2. Pass the object to be detected between the sensor and reflector. The yellow LED should turn OFF. This indicates that the object has been detected.

Note: If a shiny object, such as a chrome-plated item or something with reflective tape, is within close proximity of the path of the IR beam the sensor may not be able to detect the passing object. In this case it may be necessary to turn the sensitivity knob counter-clockwise until the desired sensitivity setting is obtained.

Fig. 2

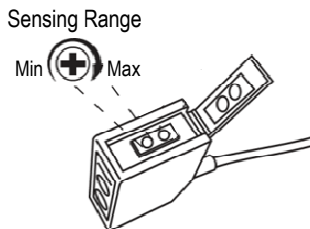

Note: Depending on the monitoring system used by the gate motor, it may be necessary to use either the N.C. output or the built-in 10kΩ resistor on the N.O. output. Please refer to the gate operator manual or the gate operator manufacturer for the preferred monitoring method.

The E-936-S45RRGQ will not work with gate operators that monitor using the "heartbeat" method.

ENFORCER Retro-Reflective Photoelectric Beam Sensor

Wiring:

Connection (5 wires)

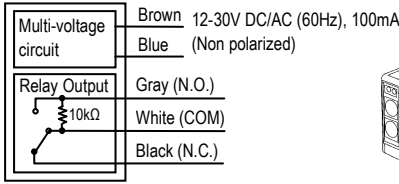

Note:

1. Can be connected to AC or DC voltage
2. Maximum cable extension length is 325 ft (100 m)

Mounting the Sensor:

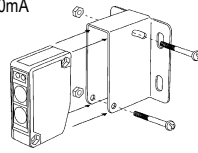

For E-931ACC-BLS5Q Bracket

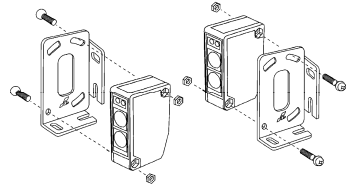

For E-931ACC-BLS1Q Bracket

Troubleshooting:

Sensor does not detect the object. • Change the angle of the sensor or readjust the sensitivity setting

Yellow LED does not turn on

- Clean the sensor and reflector with a damp (not wet) cloth
- Adjust the reflector and/or sensor for proper alignment

Optional Accessories Available from SECO-LARM®:



E-931ACC-R2Q
Square Reflector



E-931ACC-RC1Q
Round Reflector



E-931ACC-HR1Q
Reflector Hood for
Round/Square Reflector



E-931ACC-BLR2Q
Reflector Bracket



E-931ACC-BLS1Q
Sensor Bracket



E-931ACC-BLS5Q
Sensor Bracket



E-931ACC-BLS7Q
Wall Bracket



E-931ACC-BLS8Q
Door Frame Bracket



E-931ACC-BLS6Q
Single-gang Bracket

WARRANTY: This SECO-LARM product is warranted against defects in material and workmanship while used in normal service for 1 (one) year from the date of sale to the original customer. SECO-LARM's obligation is limited to the repair or replacement of any defective part if the unit is returned, transportation prepaid, to SECO-LARM. This Warranty is void if damage is caused by or attributed to acts of God, physical or electrical misuse or abuse, neglect, repair or alteration, improper or abnormal usage, or faulty installation, or if for any other reason SECO-LARM determines that such equipment is not operating properly as a result of causes other than defects in material and workmanship. The sole obligation of SECO-LARM and the purchaser's exclusive remedy, shall be limited to the replacement or repair only, at SECO-LARM's option. In no event shall SECO-LARM be liable for any special, collateral, incidental, or consequential personal or property damage of any kind to the purchaser or anyone else.

NOTICE: The SECO-LARM policy is one of continual development and improvement. For that reason, SECO-LARM reserves the right to change specifications without notice. SECO-LARM is also not responsible for misprints. All trademarks are the property of SECO-LARM U.S.A., Inc. or their respective owners. Copyright © 2017 SECO-LARM U.S.A., Inc. All rights reserved.

SECO-LARM® U.S.A., Inc.

16842 Millikan Avenue, Irvine, CA 92606
Phone: (949) 261-2999 | (800) 662-0800

Website: www.seco-larm.com
Email: sales@seco-larm.com



ML_E-936-S45RRGQ_170919.docx