

Installation/Owner's Manual

1601 / 1602

Barrier Gate Operator

Use this manual for circuit board 1601-010 Revision W or higher.

1601-065-D-12-17

THIS PRODUCT IS TO BE INSTALLED AND SERVICED BY A TRAINED GATE SYSTEMS TECHNICIAN ONLY.
Visit www.dkslocator.com to find a professional installing and servicing dealer in your area.

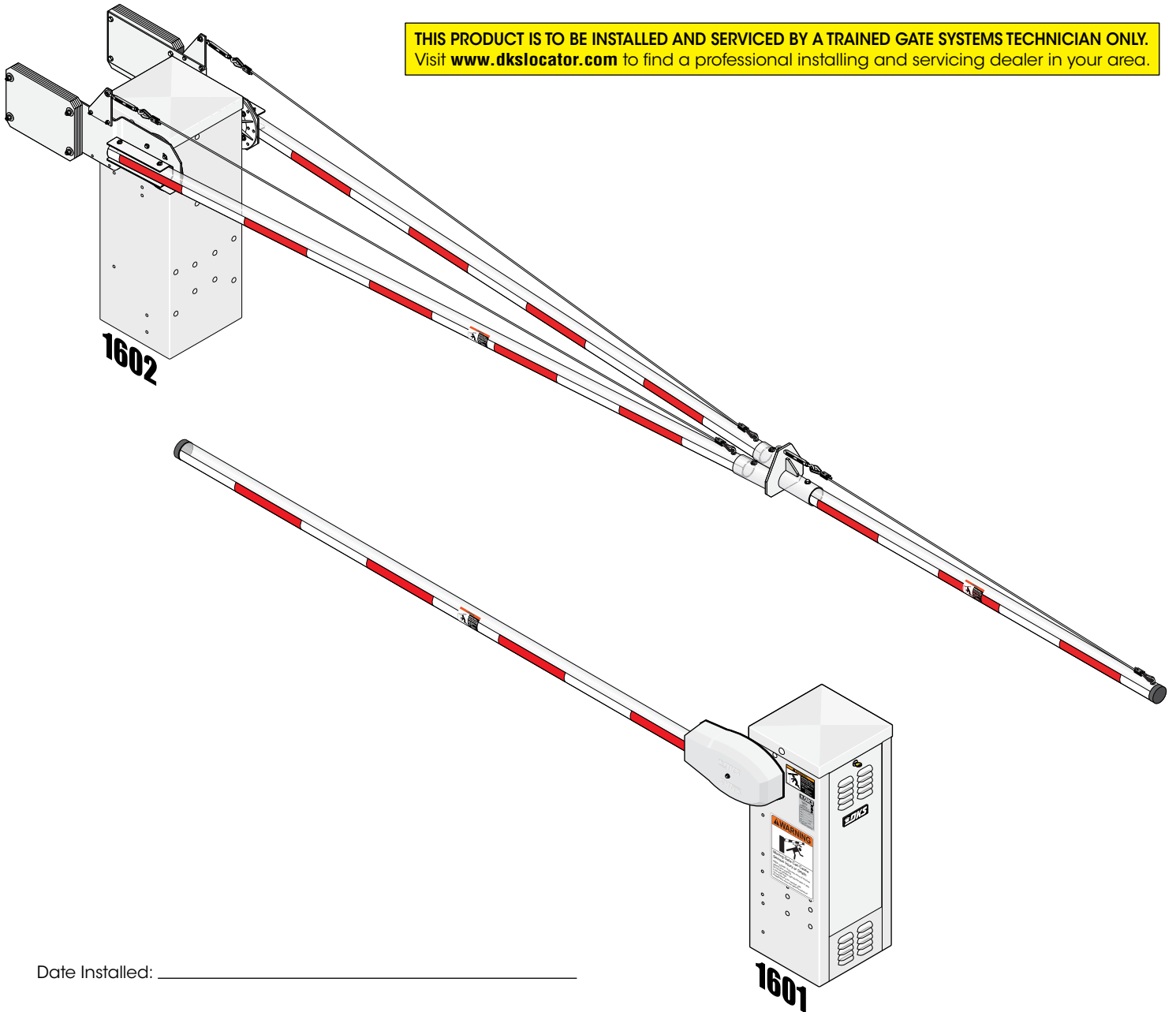

Date Installed: _____

Installer/Company Name: _____

Phone Number: _____

Circuit Board
Serial Number
and Revision Letter: _____

Leave Manual with Owner

Copyright 2017 DoorKing, Inc. All rights reserved.



UL 325 Compliant



UL 325 Entrapment Protection for Vertical Barrier Arm

UL 325 Classifications



Class I - Residential Vehicular Gate Operator

A vehicular gate operator (or system) intended for use in garages or parking areas associated with a residence of one-to four single families. This does **NOT** apply to a vertical barrier arm.



Class III - Industrial/Limited Access Vehicular Gate Operator

A vehicular gate operator (or system) intended for use in an industrial location or building such as a factory or loading dock area or other locations not accessible by or intended to service the general public.

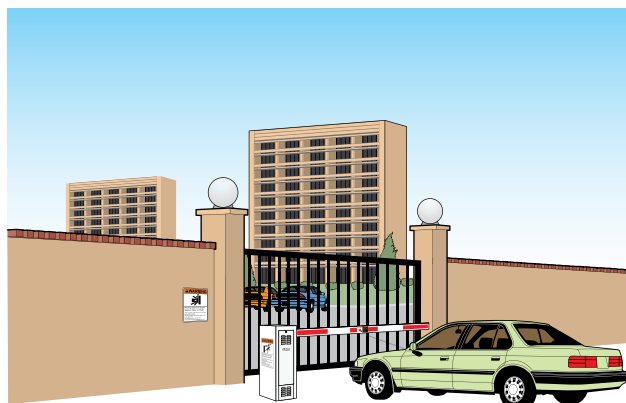

Class II - Commercial/General Access Vehicular Gate Operator

A vehicular gate operator (or system) intended for use in a commercial location or building such as a multi-family housing unit (five or more single family units), hotel, garages, retail store, or other buildings accessible by or servicing the general public.



Class IV - Restricted Access Vehicular Gate Operator

A vehicular gate operator (or system) intended for use in a guarded industrial location or building such as an airport security area or other restricted access locations not servicing the general public, in which unauthorized access is prevented via supervision by security personnel.

Gate Operator Category

Effective January 12, 2016	Horizontal Slide, Vertical Lift, Vertical Pivot	Swing, Vertical Barrier (Arm)
Entrapment Protection Types	A, B1*, B2* or D	A, B1*, B2*, C or D

Type A - Inherent entrapment protection system.

Type B1 - Non-contact sensor (photoelectric sensor or the equivalent).

Type B2 - Contact sensor (edge device or equivalent).

Type C - Inherent force limiting, inherent adjustable clutch or inherent pressure relief device.

Type D - Actuating device requiring constant pressure to maintain opening or closing motion of the gate.

* B1 and B2 means of entrapment protection must be MONITORED.

Vertical Barrier Note: Barrier gate operators (arm) that is not intended to move toward a rigid object closer than 16 inches (406 mm) are not required to be provided with a means of entrapment protection.

Safety and Traffic Management for Vertical Barrier Arm

Vehicular barrier gate operators can produce high levels of force. It is important that you are aware and eliminate possible HAZARDS; Pinch Points, Entrapment Areas, Overhead Power Wires, Absence of Controlled Pedestrian Access, and Traffic Management.

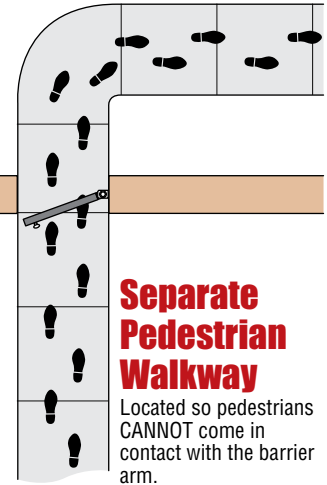
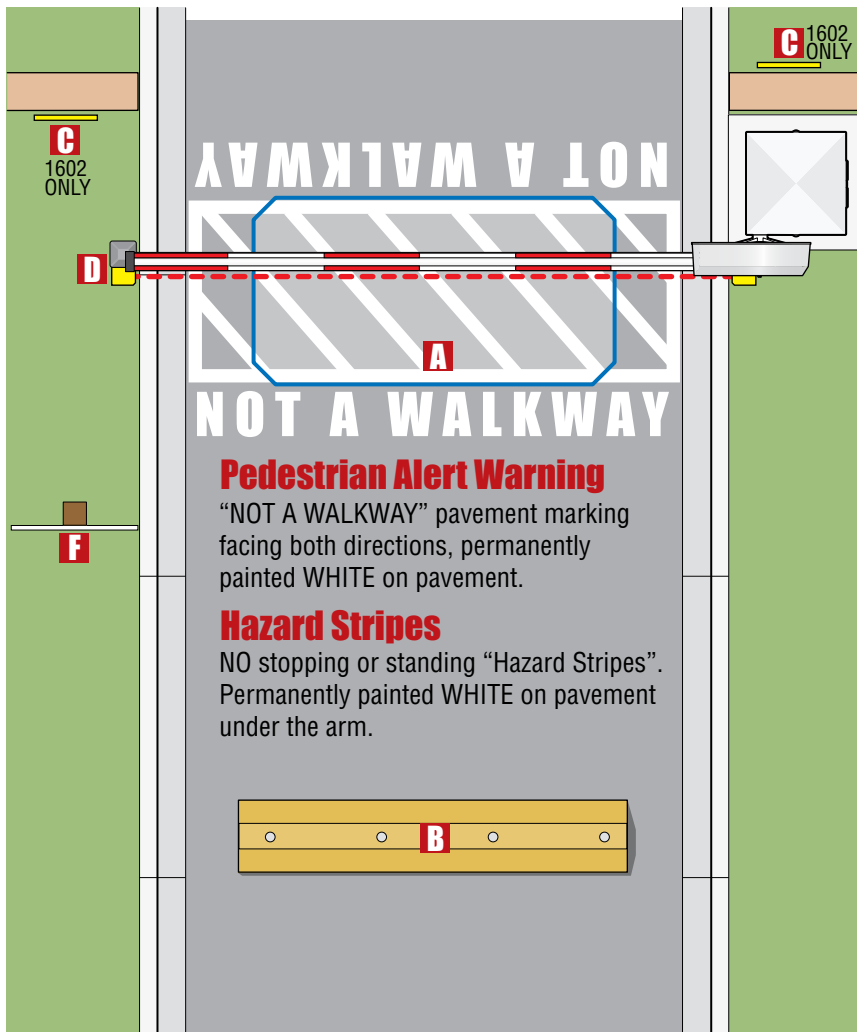

A In-Ground Loop(s)

Loops minimize the potential of the arm closing when a vehicle is present. Number and placement of loop(s) is dependent on the application.

B Speed Bump

Helps increase distance and time between vehicles.

C Warning Signs

Permanently mounted on operator and arm and easily visible.



Note: 2 warning signs are included with the 1602 and MUST be mounted on both sides of the gated area and easily visible.

D Non-Contact Sensor

Minimizes the potential of the arm lowering on vehicular or other traffic that loops cannot sense. Located directly under arm.

E Contact Sensor

Minimizes the potential of the arm lowering on vehicular or other traffic that loops cannot sense.

F Speed Limit Sign

Helps control traffic.

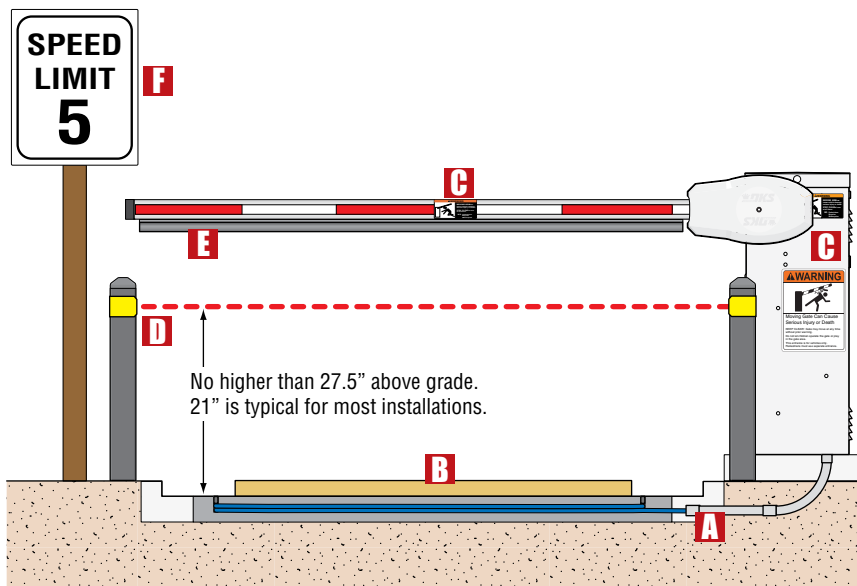

IMPORTANT Safety Information for Vertical Barrier Arm

Reduce the risk of injury or death, read and follow all instructions.

Familiarize yourself with safety warnings, instructions, illustrations, and wiring guidelines to ensure that the installation is performed in a safe and professional manner. **Prior to installation check all local building codes and ordinances to ensure compliance.**

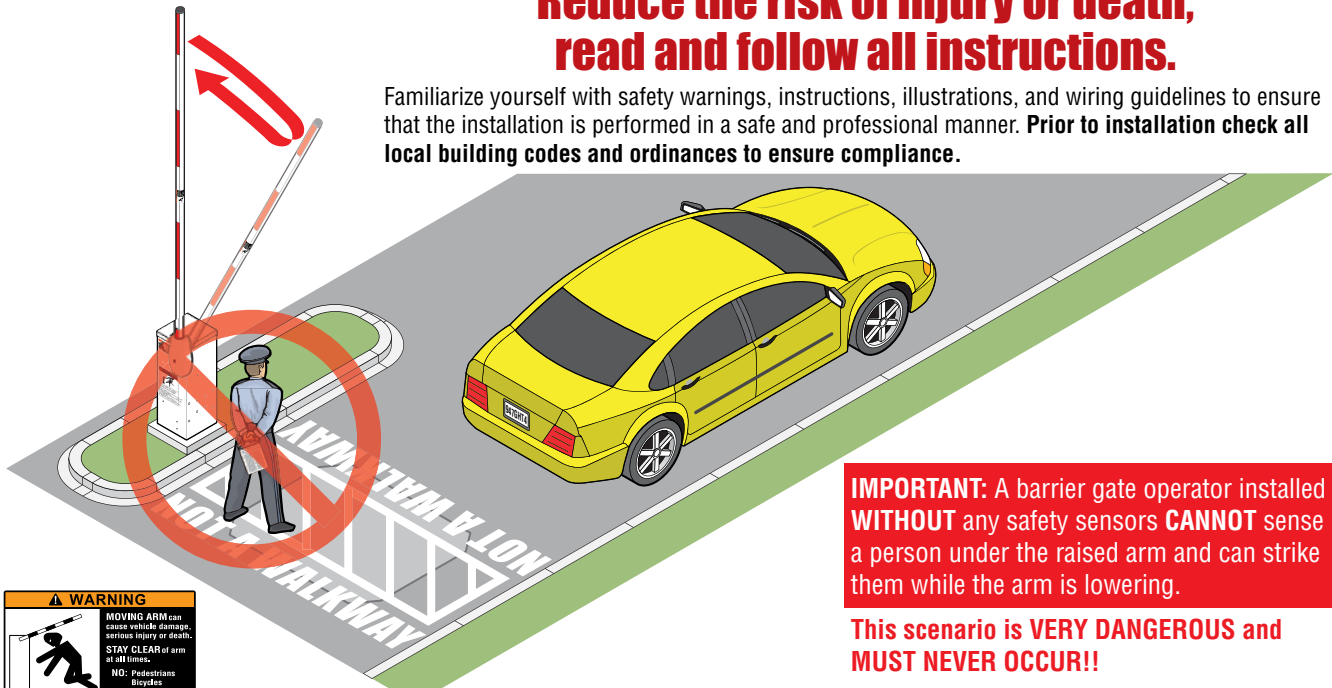

IMPORTANT: A barrier gate operator installed **WITHOUT** any safety sensors **CANNOT** sense a person under the raised arm and can strike them while the arm is lowering.

This scenario is VERY DANGEROUS and MUST NEVER OCCUR!!

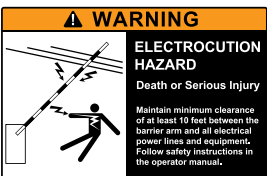
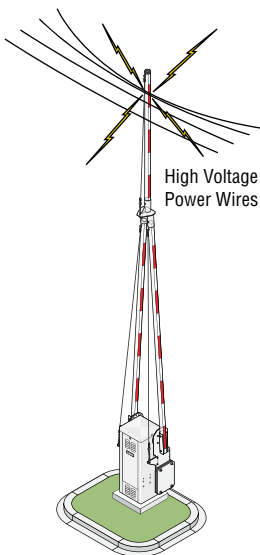

- Make sure all warning signs are on operator and arm. The 1602 2 warning signs **MUST** be mounted on **BOTH** sides of the gated area and easily visible.
- **Do not install the operator in such a way that the arm moves within 16 inches of a rigid object or 10 feet from high voltage power wires with arm in the raised position.**
- **Speed limit through barrier area is 5 MPH.** Install speed bumps, warning signs and hazard stripes where visible in the area of the barrier gate, failure to do so may result in injury, damage to operator and vehicle.
- Users should be familiar with proper use of operator, these include; hardware operation, reversing functions and testing, reversing loops, inherent reversing system, electric edges, photoelectric cells related external devices and possible hazards.
- **Keep adults, children and objects away from operator and HAZARD ZONES.**
- **Automotive traffic only - No bicycles or motorcycles. Pedestrians MUST be provided with separate access.**
- All electrical connections should be made in accordance with local electrical codes.
- Security features should be installed to **avoid unauthorized use.**
- Controls intended for user activation must be located at least six feet (6') away from any moving part of the barrier gate and where the user is prevented from reaching over, under or around the barrier gate to operate the controls. Emergency access controls only accessible by authorized personnel (e.g., fire, police, EMS) may be placed at any location in the line-of-sight of the barrier gate.
- When **manually** operating the gate operator arm, the user **MUST** make sure that the gate area is clear **BEFORE** operating the controls. Any activity in the entrance and exit lanes should be monitored to ensure a safe operation when opening or closing the barrier gate. The motion of the barrier boom must be directly observable by the person operating the barrier. While the barrier boom is in motion **NO** pedestrian and **NO** vehicle shall be in the immediate vicinity of the barrier.
- When removing the operator lift the arm to the full open position and **shut off power at the service panel.**
- **Operators and components should be properly installed and maintained** following the recommended service schedule, test the operator monthly. Keep all debris away from operator housing vents and off of arm. Contact your service dealer for any maintenance or repairs.
- Vehicular barrier gate operators can produce high levels of force, it is important that you are aware and **eliminate possible HAZARDS; Pinch Points, Entrapment Areas, Overhead Power Wires, Absence of Controlled Pedestrian Access, Traffic Backup.**

DoorKing Recommended Safety for Vertical Barrier Arm

Reduce the risk of injury or death to a pedestrian, DoorKing recommends installing a non-contact sensor directly under the arm.

The barrier gate operator **CANNOT** sense a pedestrian under the raised arm without installing an external safety device. To help protect against an arm lowering on a pedestrian, **DoorKing recommends installing a photo sensor directly under the arm.**

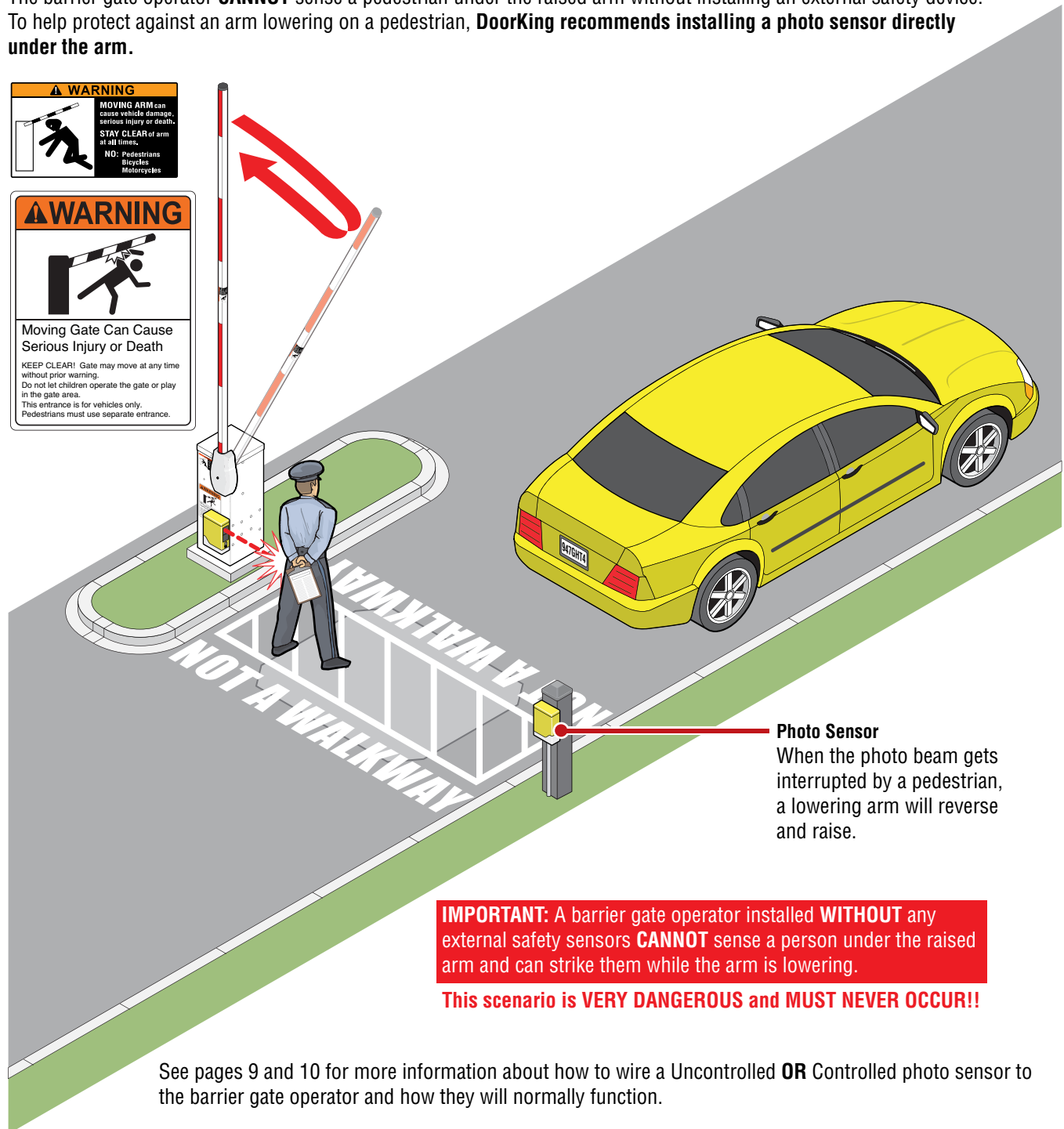

See pages 9 and 10 for more information about how to wire a Uncontrolled **OR** Controlled photo sensor to the barrier gate operator and how they will normally function.

QUICK GUIDE: Terminal Descriptions



Relay Contacts

Input LEDs:

The LED that is above the terminal wiring input will light when that terminal input gets activated.

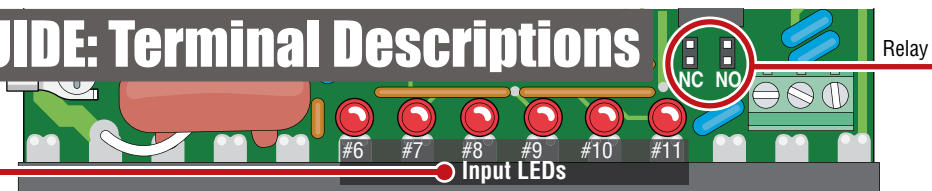

Terminal #5 Note:
Exceeding 250 mA of power from this terminal may cause the circuit board transformer to overheat, causing intermittent problems.

115 VAC Motor
115 VAC Power
115 VAC Motor
115 VAC Motor

24 VAC - 250 mA max.

UP Input

UP INPUT or UP LOOP Output

DOWN/REVERSE Input

REVERSE Input

MOMENTARY UP Input

ENABLE UP Input

Dry Relay Contact

Dry Relay Contact

Low Voltage Common

DANGER HIGH VOLTAGE!

Function is dependent on the setting of programming SW 1, switch 6. When switch 6 is **OFF**, this input will cause the operator to rotate the arm to the up position. If the arm is in the down cycle, this input will reverse the arm to the up position. If this terminal has a constant input, the arm will remain in the up position regardless of any down input or timer command to rotate down. When switch 6 is **ON**, this input will cause the operator to rotate the arm to the up position when it is down, and will cause the operator to rotate the arm to the down position when it is up. If the auto timer is turned ON (Not recommended if switch 6 is ON), this input will override the timer and rotate the arm to the down position. If the arm is in the down cycle, this input will reverse the arm to the up position.



Function is dependent on the setting of programming SW 1, switch 5. When switch 5 is **OFF**, activation of the down loop will activate the relay. When switch 5 is **ON**, activation of the UP loop will activate the relay.

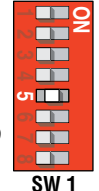

Relay contacts can be set for Normally Open (NO) or Normally Closed (NC) operation.
Contact rating is 1 amp maximum at 24 Volts.

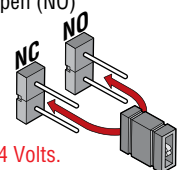

Function is dependent on the setting of programming SW 1, switch 8. When switch 8 is **ON**, the function of this input is identical to terminal 6. When switch 8 is **OFF**, this terminal becomes the logic output of the up loop detector.

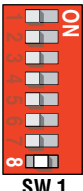

Function is dependent on the setting of programming SW 1, switches 1 and 4. With switch 1 **OFF** and switch 4 **ON**, activation and then deactivation of this input will rotate the arm to the down position, provided that the deactivation of the input happens while the arm is in the full up position. This input will override the auto timer if it is turned **ON**. If the arm is in the down position, traveling in the down cycle, or traveling in the up cycle, activation and deactivation of this input has no effect on the arm. With switches 1 and 4 are **ON**, activation and then deactivation of this input will rotate the arm to the down position after it reaches the full up position regardless of when the deactivation of the input occurred. When switch 4 is **OFF**, this input is identical to the reverse input, terminal 9.

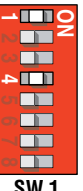

This input is used when sequencing the 1601 with a slide or swing gate operator in **PAMS** applications. This input is only active after a **MOMENTARY UP** input is received. Activation of this input will rotate the arm to the up position or reverse an arm in the down cycle to the up position.

This input is used when sequencing the 1601 with a slide or swing gate operator in **PAMS** applications. Activation of this input will rotate the arm to the up position one time, and activates the enable up input.



See pages 9 and 10 for terminal wiring.

When the arm is in the down position, activation of this input has no effect. When the arm is in the up position, activation of this input will prevent the arm from rotating to the down position. If the arm is in the down cycle, activation of this input will reverse the arm to the up position. This input can be controlled to allow the arm to lower for tailgating vehicles but NOT get lowered when a pedestrian is underneath it. The 9411 plug-in loop detector must be installed for this function, see page 10 for more information about controlled non-contact sensors.

TABLE OF CONTENTS

IMPORTANT SAFETY INFORMATION	Safety-1-4
QUICK GUIDE - TERMINAL DESCRIPTIONS	Quick Guide-1
SPECIFICATIONS FOR 1601 AND 1602	2-3
SECTION 1 - INSTALLATION	4
1.1 Underground Conduit Requirements	4
1.2 New Concrete Pad	5
1.3 Trenching Existing Concrete	5
SECTION 2 - WIRING	6
2.1 High Voltage Wire Runs	6
2.2 High Voltage Terminal Connections	6
2.3 Dual Gate Operators (Primary/Secondary)	7
2.4 Main Terminal Description	8
2.5 Control Wiring	9-10
2.6 P.A.M.S. Multiple Gate Operator Sequencing	11
SECTION 3 - LOOP DETECTOR LANE SETUPS	12
3.1 Entry Lane Only	12
3.2 Exit Lane Only	13
3.3 2-Way Traffic Lane	14
3.4 Ticket Spitter Entry Lane	15
3.5 Operator Timer ON Entry Lane (No Down Loop)	16
SECTION 4 - ARM INSTALLATION	17
4.1 Mounting Hub(s)	17
4.2 Mounting Arm(s)	18
4.3 1602 3-Piece Arm Assemblies	18
SECTION 5 - ADJUSTMENTS	19
5.1 1601 Circuit Board Description and Adjustments	19
5.2 DIP-Switch SW 1 and SW 2 Settings	20-22
5.3 Reverse Arm UP and DOWN Positions	23
5.4 Magnetic Limit Adjustment	24
5.5 Reverse Sensor Adjustment	24
5.6 Manual Operation of the Arm	25
SECTION 6 - OPTIONAL CONVENIENCE OPEN SYSTEM	26
6.1 Circuit Board Settings and Descriptions	26
6.2 DC System Wire Schematic	27
SECTION 7 - OPTIONAL ACCESSORIES INSTALLATION	28
7.1 Contact Sensor (Reversing Edge)	28
7.2 Fan Kit	29
7.3 Heater Kit	30
SECTION 8 - TECHNICAL INSTRUCTIONS	31
8.1 Maintenance Schedule	31
8.2 Diagnostics Check	32
8.3 Troubleshooting	32-33
8.4 Accessories Parts List	34
Wiring Schematics	35-36

1601 SPECIFICATIONS

Use this manual for the Model 1601 operators with circuit board 1601-010 Rev W or higher ONLY.



Class of Operation

Model 1601 - UL 325 Class II, III, IV – ETL Listed

Type of Gate

Single Traffic Lane Vehicular Barrier Gate Only

Arm Types

Wood/Plastic/Aluminum – Straight or Folding Arm

Gate Cycles

High Cycle

Pedestrian Protection

Inherent entrapment sensing system (Type A)

Provision for connection of a non-contact sensor (Type B1) and/or contact sensor (Type B2)

Model #	Convenience Open	Horsepower - Volts	Amp	Max Arm Length	Speed 90°
1601-080	No	1/2 HP - 115 VAC	5.7	14 Ft.	1.5 Sec
1601-081	Yes	1/2 HP - 115 VAC	5.7	14 Ft.	1.5 Sec

Note: 208/230/460/575 VAC input voltage can be connected to the operator by installing an "Optional" High Voltage Kit (P/N 2600-266).

1601 Housing

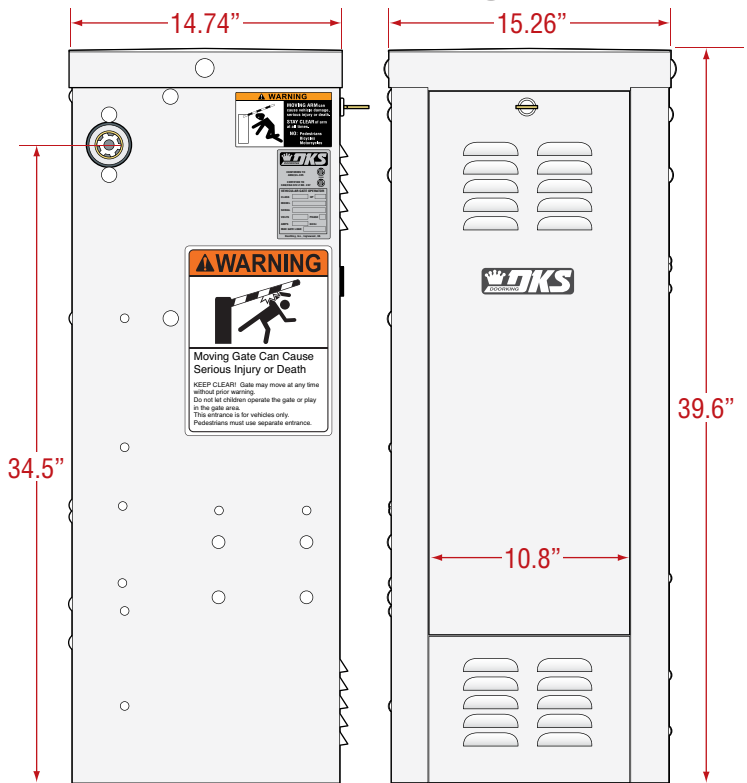

1601 Barrier Arm Options

Plastic



12 Ft. Plastic Arm Only
P/N 1601-571
Plastic Arm Mounting Kit (No Arm)
P/N 1601-241
Plastic Folding Arm Kit (With Arm)
P/N 1601-383

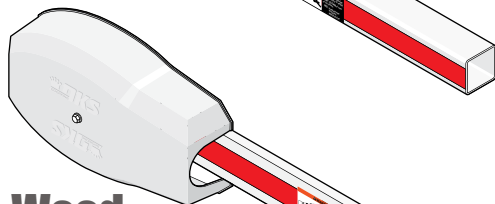

Wood

14 Ft. Wood Arm Only
P/N 1601-348
Wood Arm Mounting Kit (No Arm)
P/N 1601-240
Wood Folding Arm Kit (With Arm)
P/N 1601-384

Aluminum

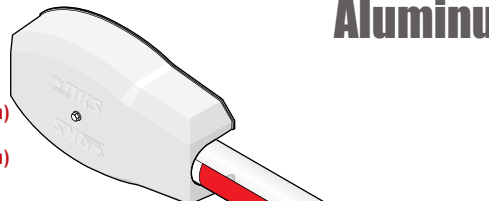

Standard Aluminum Arm
14 Ft. Aluminum Arm Only
P/N 1601-516
Aluminum Arm Mounting Kit (No Arm)
P/N 1601-242
Aluminum Folding Arm Kit (With Arm)
P/N 1601-610

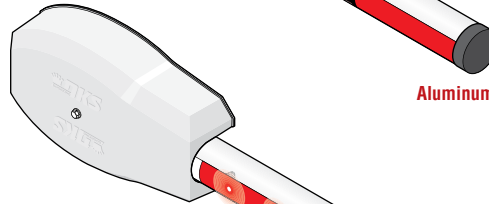

Break-Away Aluminum Arm
14 Ft. Aluminum Break-Away Arm Only
P/N 1601-522
Aluminum Break-Away Arm Mounting Kit (No Arm)
P/N 1601-285

Notes:

- Folding arm kits are for low headroom applications.
- Break-Away arms **CANNOT** be used on a convenience open operator.

Lighted Aluminum Arm

14 Ft. Aluminum LED Arm Only
P/N 1601-518
Aluminum LED Arm Mounting Kit (No Arm)
P/N 1601-531

Lighted Break-Away Aluminum Arm

14 Ft. Aluminum LED Break-Away Arm Only
P/N 1601-520
Aluminum Break-Away Arm Mounting Kit (No Arm)
P/N 1601-285

DoorKing, Inc. reserves the right to make changes in the products described in this manual without notice and without obligation of DoorKing, Inc. to notify any persons of any such revisions or changes. Additionally, DoorKing, Inc. makes no representations or warranties with respect to this manual. This manual is copyrighted, all rights reserved. No portion of this manual may be copied, reproduced, translated, or reduced to any electronic medium without prior written consent from DoorKing, Inc.

1602 SPECIFICATIONS

Use this manual for the Model 1602 operators with circuit board 1601-010 Rev W or higher ONLY.

Class of Operation

Model 1602 - UL 325 Class III, IV – ETL Listed

Type of Gate

Wide Traffic Lane Vehicular Barrier Gate Only

Arm Types

Wood/Aluminum 3-piece counter-balanced assembly

Gate Cycles

Low Cycle

Pedestrian Protection

Inherent entrapment sensing system (Type A)

Provision for connection of a non-contact sensor (Type B1) and/or contact sensor (Type B2)

Model #	Convenience Open	Horsepower - Volts	Amp	Max Arm Length	Speed 90°
1602-080	No	1 HP - 115 VAC	9.7	28 Ft.	5.5 Sec
1602-081	Yes	1 HP - 115 VAC	9.7	28 Ft.	5.5 Sec

Note: 208/230/460/575 VAC input voltage can be connected to the operator by installing an "Optional" High Voltage Kit (P/N 2600-266).



2 Warning Signs (Included) MUST be mounted on EACH side of gated area and easily visible.

1602 Housing

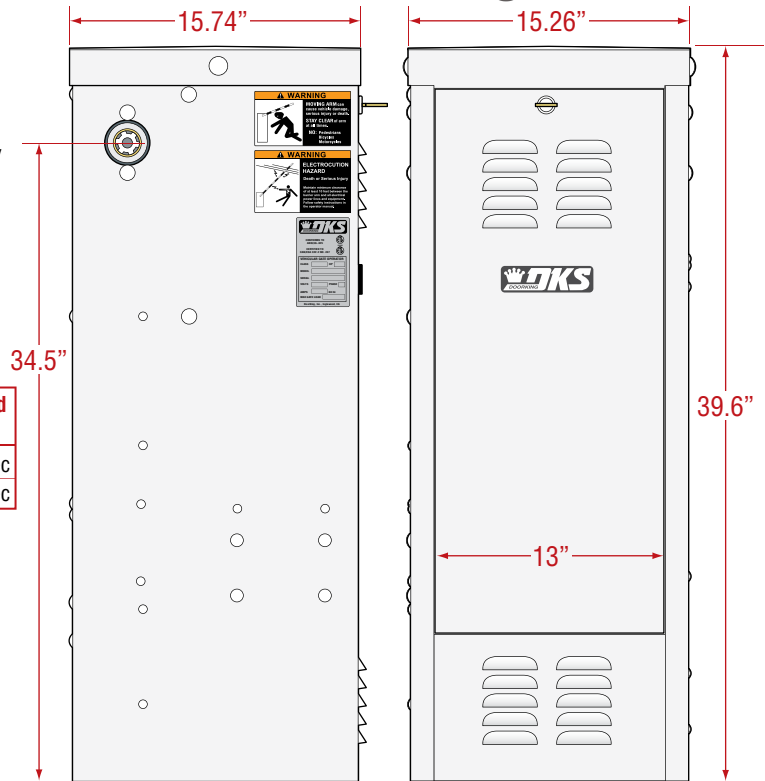

Drawings not to scale

1602 Barrier Arm Kit Options

Standard Aluminum Arm

3-Piece 20 Ft. Aluminum Arm Kit P/N 1602-162

3-Piece 24 Ft. Aluminum Arm Kit P/N 1602-164

3-Piece 27 Ft. Aluminum Arm Kit P/N 1602-166

(All hardware included in kits)

Lighted Aluminum Arm

3-Piece 20 Ft. Lighted Aluminum Arm Kit P/N 1602-172

3-Piece 24 Ft. Lighted Aluminum Arm Kit P/N 1602-174

3-Piece 27 Ft. Lighted Aluminum Arm Kit P/N 1602-176

(All hardware included in kits)

3-Piece 20 Ft. Wood Arms Only P/N 1602-340

3-Piece 20 Ft. Wood Arms Mounting Kit P/N 1602-041

SECTION 1 - INSTALLATION

Prior to beginning the installation of the barrier gate operator, we suggest that you become familiar with the instructions, illustrations, and wiring guide-lines in this manual. This will help insure that your installation is performed in an efficient and professional manner.

The proper installation of the vehicular barrier gate operator is an extremely important and integral part of the overall access control system. Check all local building ordinances and building codes prior to installing this operator. Be sure your installation is in compliance with local codes.

1.1 Underground Conduit Requirements

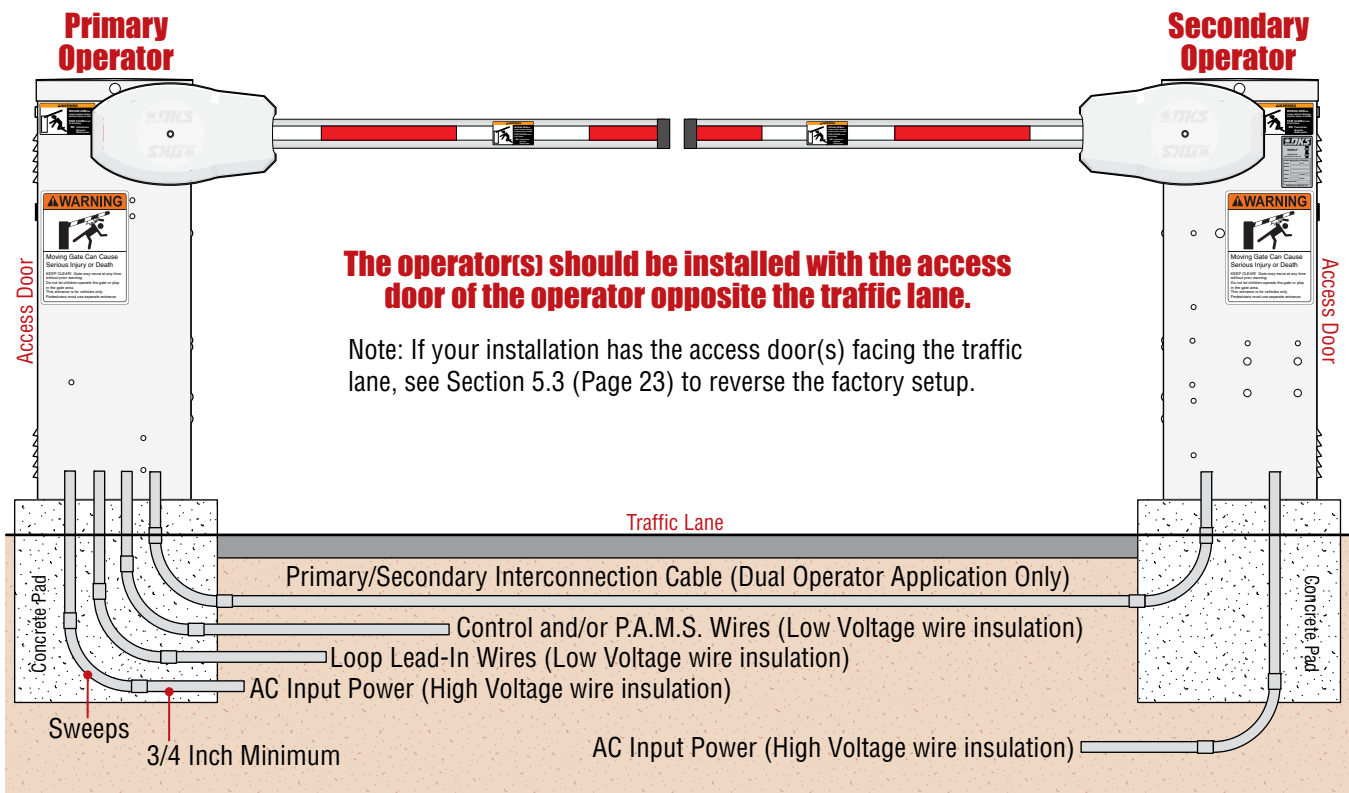

- The conduit requirements are for a typical slide gate operator installation (the secondary operator is shown for those applications where a secondary operator may be used). **The conduit requirements for your application may vary from this depending on your specific needs.**
- Use only sweeps for conduit bends. Do not use 90° elbows as this will make wire pulls very difficult and can cause damage to wire insulation.
- DoorKing recommends using 3/4-inch conduit.
- Be sure that all conduits are installed in accordance with local codes.
- **Never** run low voltage rated wire insulation in the same conduit as high voltage rated wire insulation.

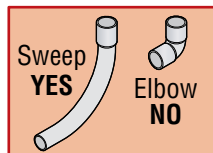

1.2 New Concrete Pad

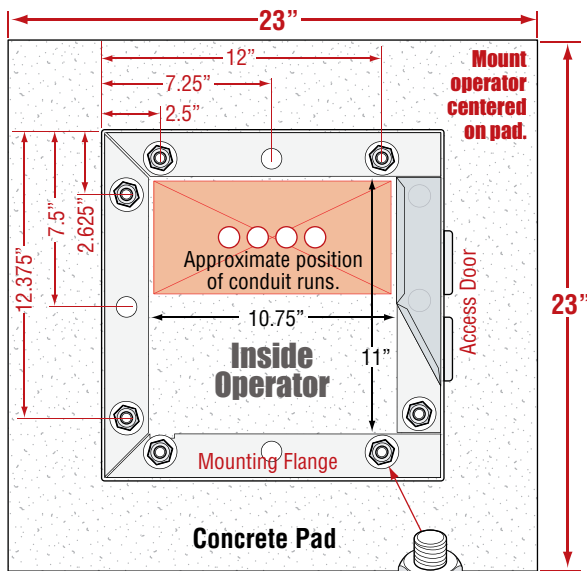

IMPORTANT: A barrier gate operator installed **WITHOUT** any external safety sensors **CANNOT** sense a person under the raised arm and can strike them while the arm is lowering. DoorKing recommends installing an external photo sensor directly under the arm. See safety pages in front of this manual for more information.

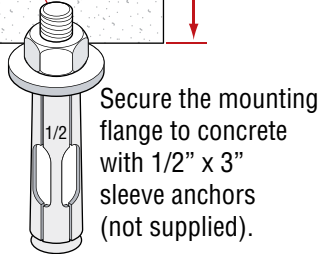

The operator(s) should be installed with the access door of the operator opposite the traffic lane.

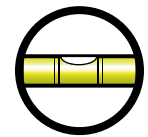

Concrete pad MUST be level.
Note: Bevel the edges of concrete pad to eliminate water puddling under the operator.

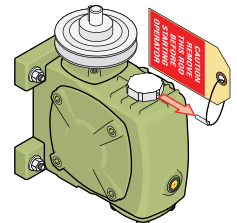
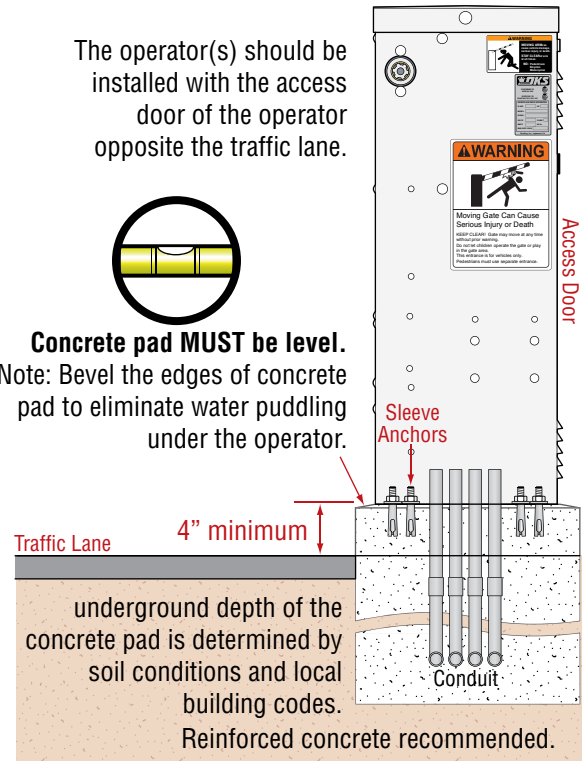

Remove breather pin from gear reducer **AFTER** the operator has been secured in place.

1.3 Trenching Existing Concrete

Trench path(s) in the existing concrete wide enough for all the conduit runs. After the conduit has been run, fill the trench with soil to bottom of existing concrete and tamp down. Pour new concrete with a 4 inch pad height minimum (Reinforce concrete if possible). Secure the mounting flange to concrete with 1/2" x 3" sleeve anchors (not supplied). See illustration above for mounting operator.

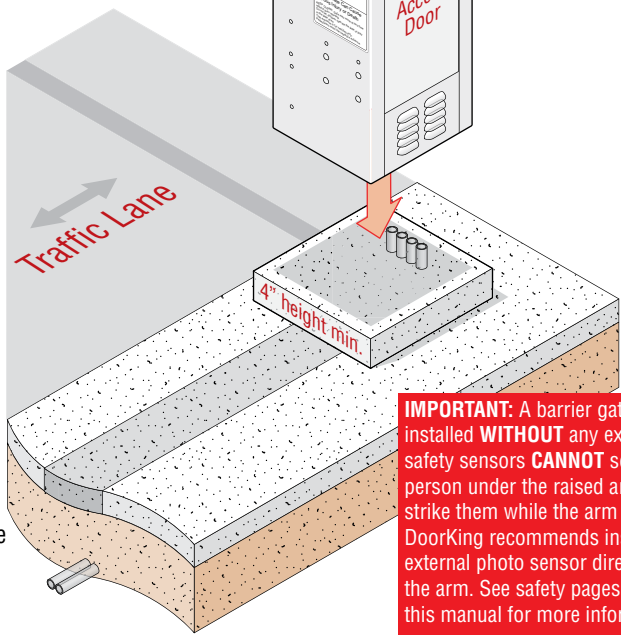
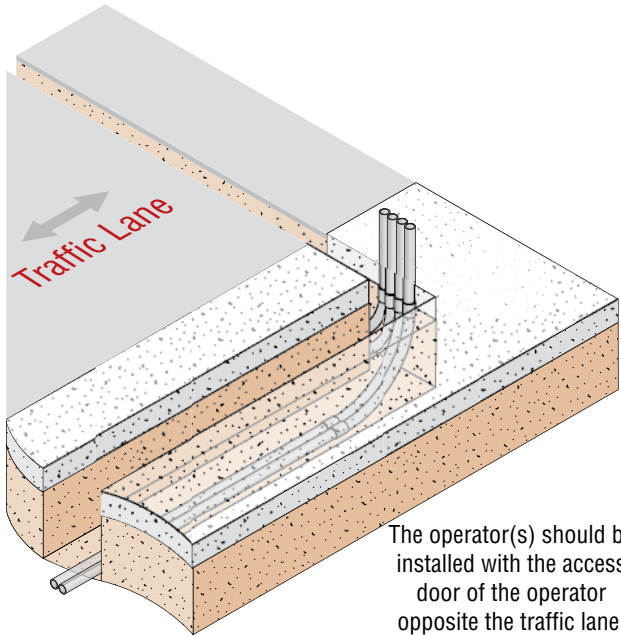

IMPORTANT: A barrier gate operator installed **WITHOUT** any external safety sensors **CANNOT** sense a person under the raised arm and can strike them while the arm is lowering. DoorKing recommends installing an external photo sensor directly under the arm. See safety pages in front of this manual for more information.

SECTION 2 - WIRING

Before attempting to connect any wiring to the operator, be sure that the circuit breaker in the electrical panel is in the OFF position. Permanent wiring must be installed to the operator as required by local electrical codes. It is recommended that a licensed electrical contractor perform this work.

Since building codes vary from city to city, we highly recommend that you check with your local building department prior to installing any permanent wiring to be sure that all wiring to the operator (both high and low voltage) complies with local code requirements.

THIS GATE OPERATOR MUST BE PROPERLY GROUNDED!!

2.1 High Voltage Wire Runs

The distance shown in the chart is measured in “Feet” from the operator to the power source. If power wiring is greater than the maximum distance shown, it is recommended that a service feeder be installed. When large gauge wire is used, a separate junction box must be installed for the operator connection. The wire table is based on stranded copper wire. Wire run calculations are based on the NEC recommended maximum 3% voltage drop on the power line, plus an additional 10% reduction in distance to allow for other losses in the system.

This table illustrates the high voltage AC power wire size and distance limitations.

Model Type	Voltage Required	Amps Required	Wire Size / Max Distance in Feet			
			12 AWG	10 AWG	8 AWG	6 AWG
1601 - 1/2 HP	115	5.7	170	275	460	690
1602 - 1 HP	115	9.7	100	162	270	405

Never run low voltage rated wire insulation in the same conduit as high voltage rated wire insulation.

“Optional” Heater Installation Note: When installing a heater, refer to the “high voltage AC power wire size and distance limitations” table on the instruction sheet with the heater kit for AC power wire run limitations.

“Optional” High Voltage Kit Installation Note: When installing the high voltage kit for 208/230/460/575 VAC input power, refer to the “high voltage AC power wire size and distance limitations” table on the instruction sheet with the high voltage kit (P/N 2600-266) for AC power wire run limitations.

2.2 High Voltage Terminal Connections

- Route incoming high voltage power in its **OWN** conduit.
- Be sure wiring is installed in accordance with local codes. Be sure to color code all wiring.
- It is recommended that a surge suppressor be installed on the high voltage power lines to help protect the operator and circuit board from surges and power fluctuations.
- Dual operators (Primary/Secondary) require AC power to each operator.

⚠ Keep wire clear of all moving parts.

DO NOT power up and cycle the operator until the “DIP-Switches” have been set for the 1601 **OR** 1602 model (See pages 20 and 22). The operator will not function properly unless the switches have been correctly set.

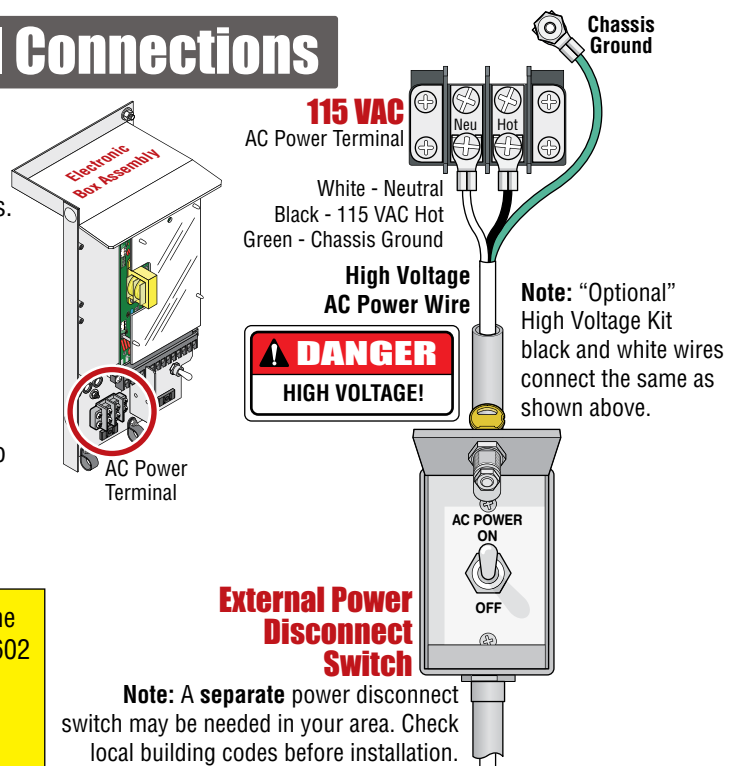

2.3 Dual Gate Operators (Primary/Secondary)

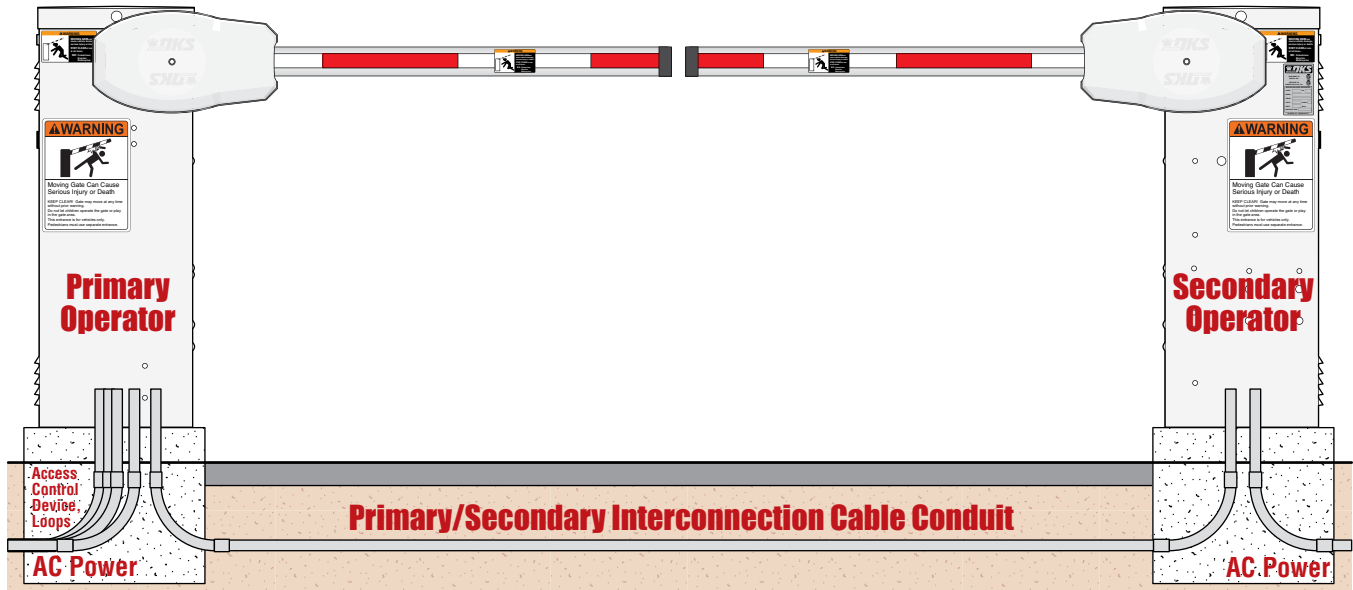

Primary Circuit Board

Secondary Circuit Board

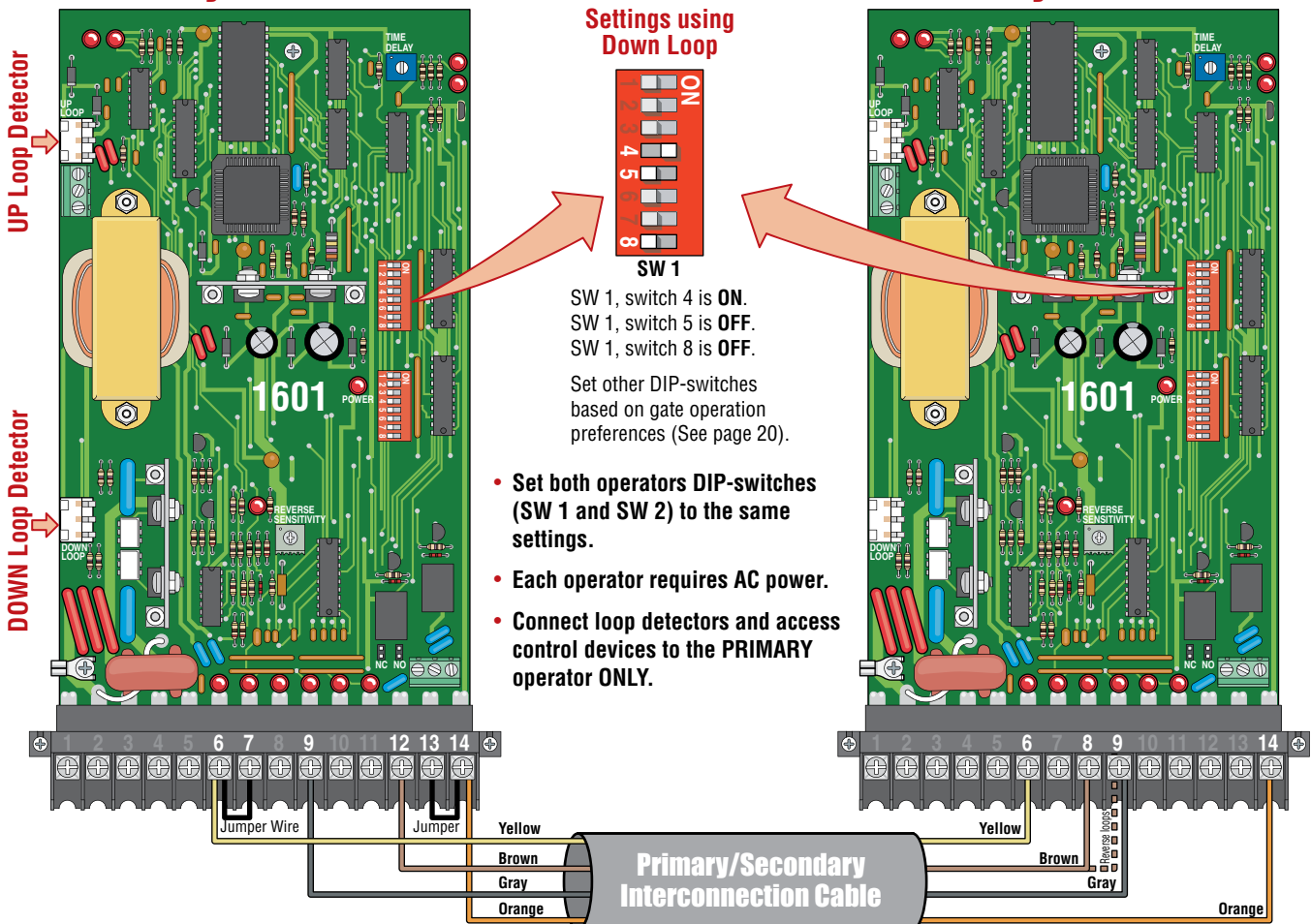

Sold separately from DoorKing.
 4 wires used (8 - 18 AWG wires total).

When using Reverse Loops:

DIP-Switch settings: SW 1, switch 4 is OFF. SW 1, switch 5 is OFF. SW 1, switch 8 is OFF. Set other DIP-switches based on gate operation preferences.

Interconnection cable: The BROWN wire must be connected to SECONDARY TERMINAL #9 along with the GRAY wire. All other terminal wire connections are the same as shown above.

2.4 Main Terminal Description

Relay Contacts

Input LEDs:

The LED that is above the terminal wiring input will light when that terminal input gets activated.

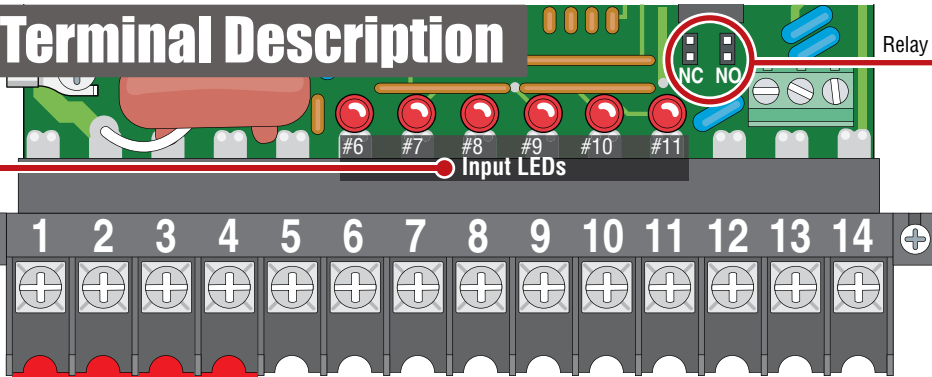

Terminal #5 Note:
Exceeding 250 mA of power from this terminal may cause the circuit board transformer to overheat, causing intermittent problems.



Function is dependent on the setting of programming SW 1, switch 6. When switch 6 is **OFF**, this input will cause the operator to rotate the arm to the up position. If the arm is in the down cycle, this input will reverse the arm to the up position. If this terminal has a constant input, the arm will remain in the up position regardless of any down input or timer command to rotate down. When switch 6 is **ON**, this input will cause the operator to rotate the arm to the up position when it is down, and will cause the operator to rotate the arm to the down position when it is up. If the auto timer is turned ON (Not recommended if switch 6 is ON), this input will override the timer and rotate the arm to the down position. If the arm is in the down cycle, this input will reverse the arm to the up position.

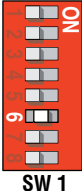

Function is dependent on the setting of programming SW 1, switch 5. When switch 5 is **OFF**, activation of the down loop will activate the relay. When switch 5 is **ON**, activation of the UP loop will activate the relay.

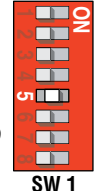

Relay contacts can be set for Normally Open (NO) or Normally Closed (NC) operation. Contact rating is 1 amp maximum at 24 Volts.

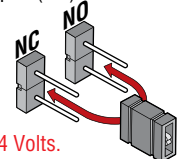

Function is dependent on the setting of programming SW 1, switch 8. When switch 8 is **ON**, the function of this input is identical to terminal 6. When switch 8 is **OFF**, this terminal becomes the logic output of the up loop detector.

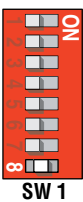

Function is dependent on the setting of programming SW 1, switches 1 and 4. With switch 1 **OFF** and switch 4 **ON**, activation and then deactivation of this input will rotate the arm to the down position, provided that the deactivation of the input happens while the arm is in the full up position. This input will override the auto timer if it is turned ON. If the arm is in the down position, traveling in the down cycle, or traveling in the up cycle, activation and deactivation of this input has no effect on the arm. With switches 1 and 4 are **ON**, activation and then deactivation of this input will rotate the arm to the down position after it reaches the full up position regardless of when the deactivation of the input occurred. When switch 4 is **OFF**, this input is identical to the reverse input, terminal 9.

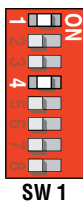

This input is used when sequencing the 1601 with a slide or swing gate operator in PAMS applications. This input is only active after a MOMENTARY UP input is received. Activation of this input will rotate the arm to the up position or reverse an arm in the down cycle to the up position.

This input is used when sequencing the 1601 with a slide or swing gate operator in PAMS applications. Activation of this input will rotate the arm to the up position one time, and activates the enable up input.



When the arm is in the down position, activation of this input has no effect. When the arm is in the up position, activation of this input will prevent the arm from rotating to the down position. If the arm is in the down cycle, activation of this input will reverse the arm to the up position. This input can be controlled to allow the arm to lower for tailgating vehicles but NOT get lowered when a pedestrian is underneath it. The 9411 plug-in loop detector must be installed for this function, see page 10 for more information about controlled non-contact sensors.



2.5 Control Wiring for Single/Primary Operator

DoorKing Access Control System (Model 1833, 1835, 1837 or 1838) tracker system can be connected. This system can keep track of gate operator cycle count, shorted inputs, loop detector problems, any forced entry attempts, if the gate has struck anything during the open or close cycle, power interruptions, etc. For more detailed information refer to the Tracker Installation and Wiring Manual, DoorKing P/N 2358-010.

Terminal 6 required only if the tracker board will activate the gate operator. Refer to the manual 2358-065 for detailed information.

Terminal #5 Note:
Exceeding 250 mA of power from this terminal may cause the circuit board transformer to overheat, causing intermittent problems.

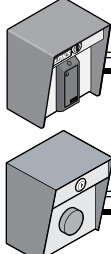
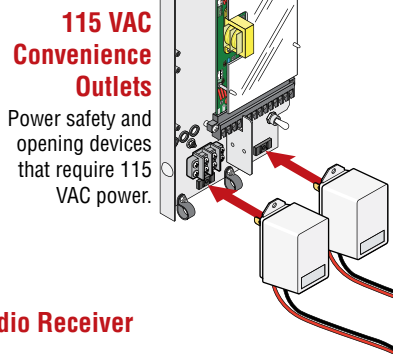
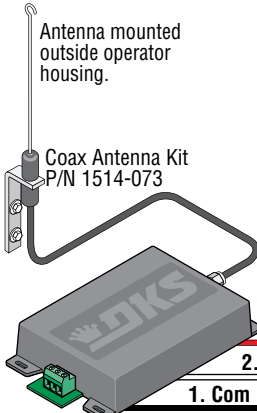
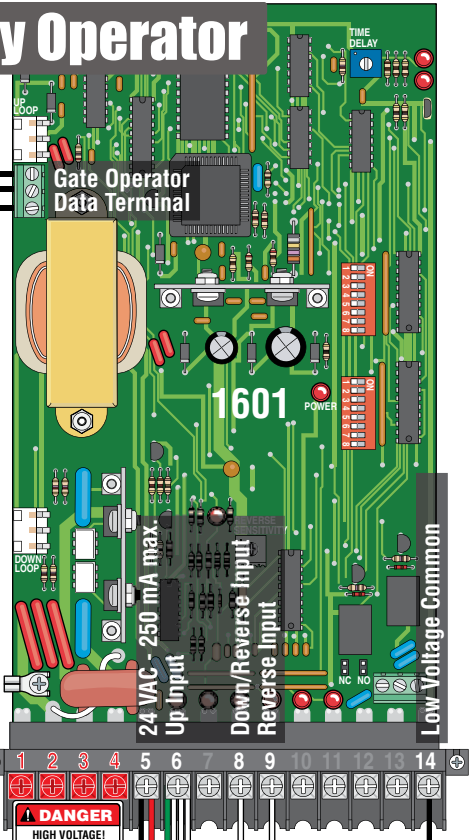
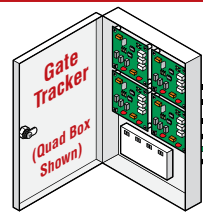

WARNING
User **MUST** make sure gate area **IS CLEAR** before manually operating gate arm.

Manual Gate Control Toggle P/N 1200-017
Up toggle position: User toggles switch up to hold gate open.
Center toggle position: Is neutral for normal operation.



Contact Sensors Note: Helps minimize the potential of the arm lowering on vehicular or other traffic that loops cannot sense.

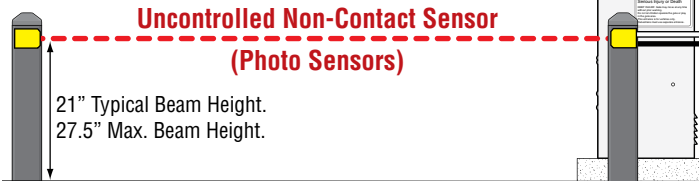

Uncontrolled Non-Contact Sensors Note: Helps minimize the potential of the arm lowering on vehicular or other traffic that loops cannot sense. **Lowering arm will always reverse when beam gets blocked.** See next page for CONTROLLED non-contact sensor layout.

2.5 Continued

Controlled Non-Contact Sensor (Optional)

DoorKing offers a way to control vehicular traffic and help protect pedestrians from a lowering arm. The arm will **NOT** allow a tailgating second vehicle unauthorized entry but prevents the raised arm from lowering on a pedestrian that is in the arm swing path when the photo beam gets interrupted. DoorKing's 9411 plug-in loop detector (sold separately) and a down loop **MUST** be installed directly under the arm for this detection system to function (see below). See instruction sheet included with 9411 loop detector for more information about loop detector adjustments and wiring.

Section 3 Note: The wiring layouts shown in section 3 **CANNOT** be used when a controlled non-contact sensor 9411 plug-in loop detector is installed.

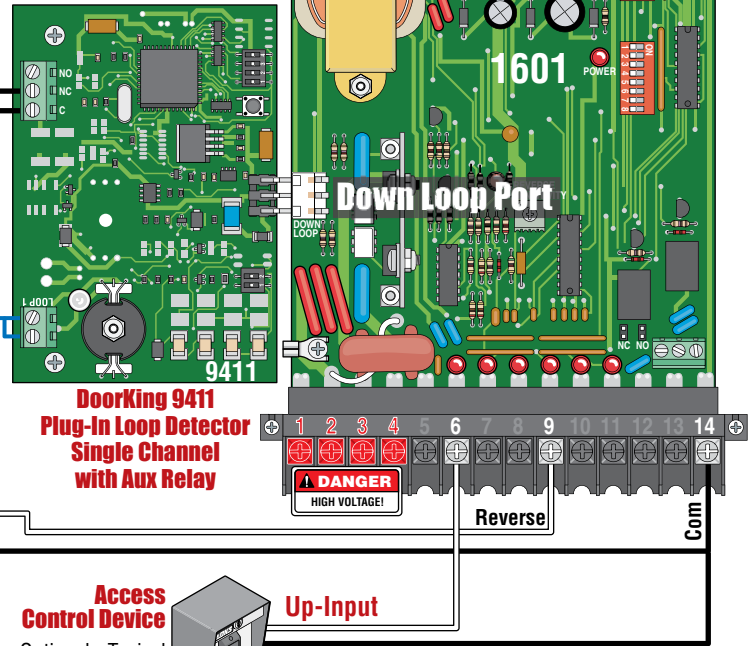
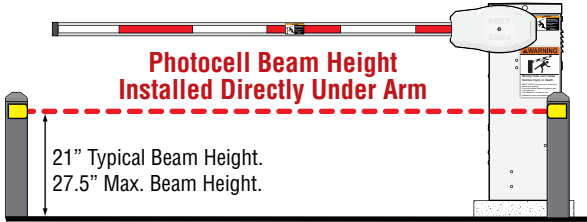
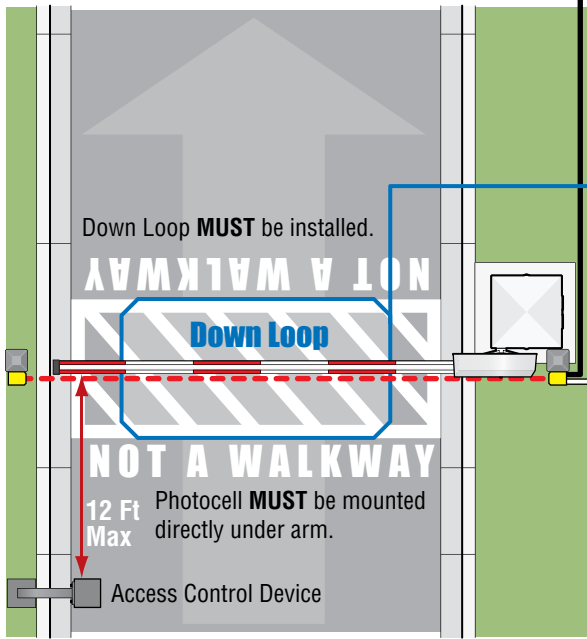

Typical DIP-Switch settings when using a 9411 Loop Detector with a Down Loop and a Access Control Device

See page 20 for more information.

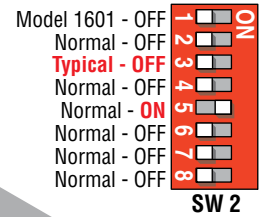
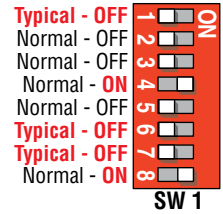

An interrupted photo beam **WILL** reverse a lowering arm for a pedestrian but will **NOT** reverse a lowering arm for an unauthorized tailgating vehicle.

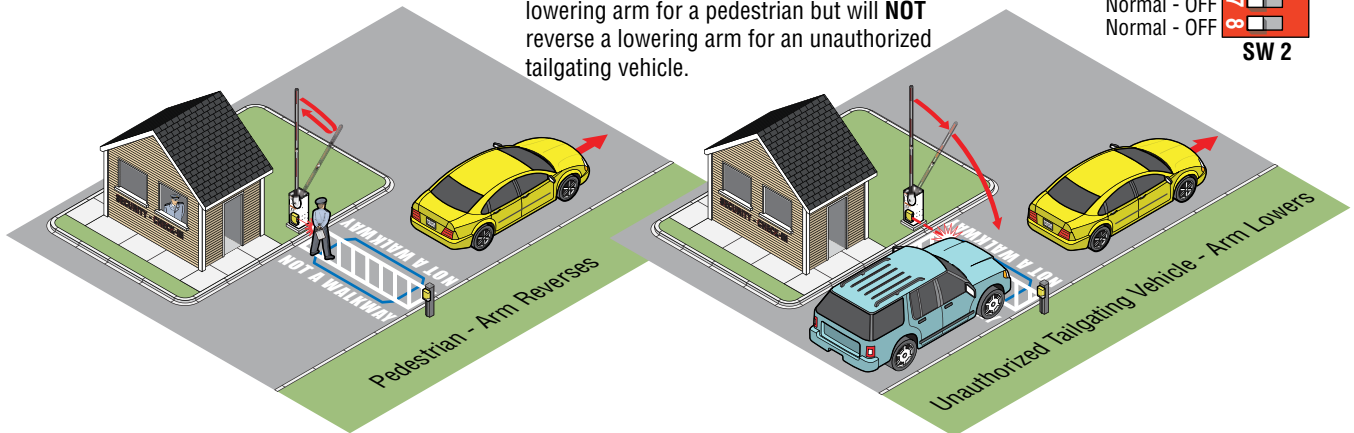

2.6 P.A.M.S. Multiple Gate Operator Sequencing

Perimeter Access Management Solution (PAMS) application allows open and close cycle sequencing of a DoorKing barrier gate operator and a DoorKing slide or swing gate operator. For detailed PAMS wiring information, refer to the PAMS Technical Information and Wiring Manual.

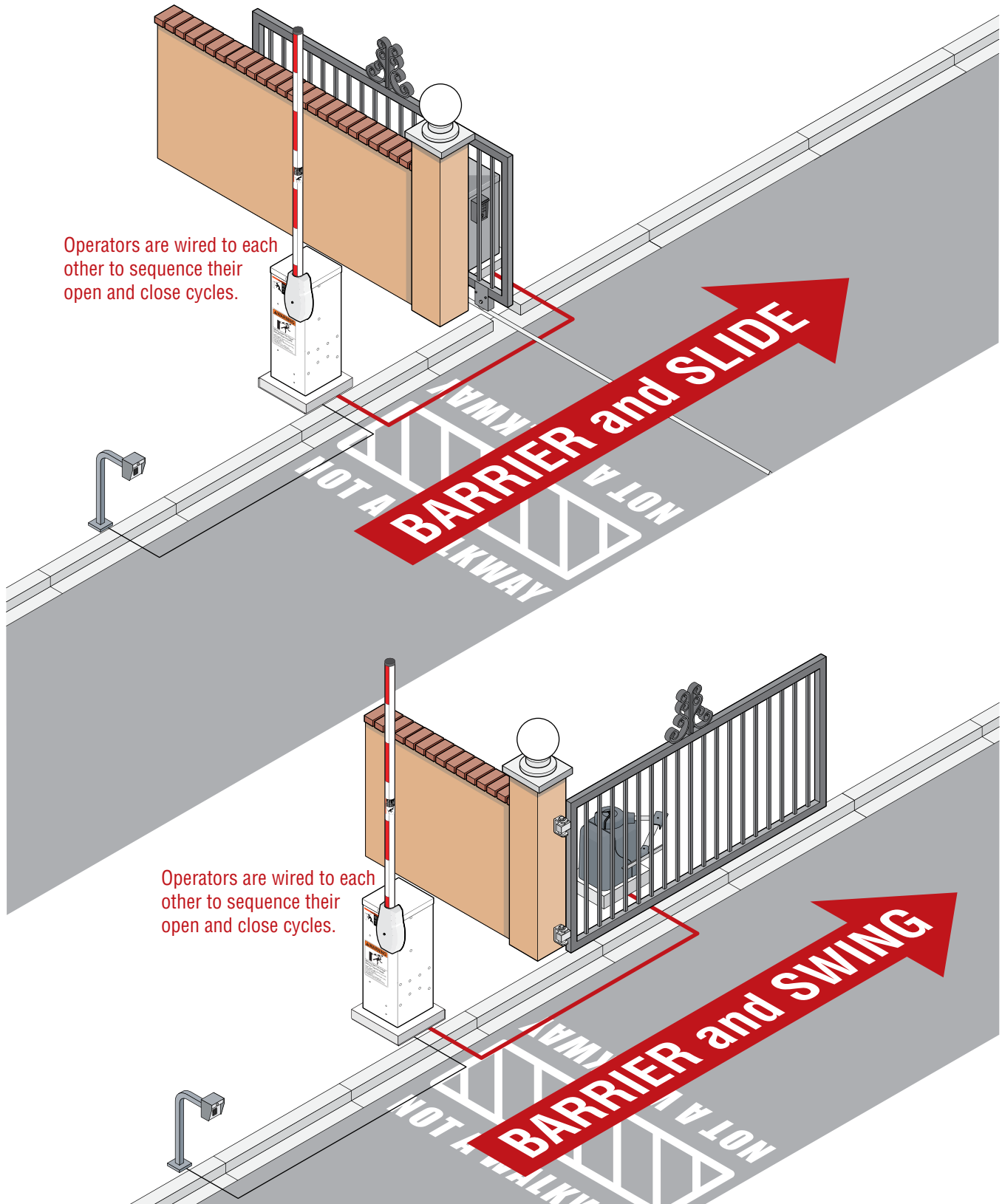

SECTION 3 - LOOP DETECTOR LANE SETUPS

Before attempting to connect any wiring to the operator, be sure that the circuit breaker in the electrical panel is in the OFF position. Permanent wiring must be installed to the operator as required by local electrical codes. It is recommended that a licensed electrical contractor perform this work.

Loop detector wiring shown is for DoorKing model 9409 Dual Channel and 9410 Single Channel plug-In loop detectors only. If using other loop detectors refer to the separate Loop Information Manual for installation instructions, loops/preformed loops and wiring diagrams. All inputs to the main terminal are NORMALLY OPEN.

3.1 Entry Lane Only

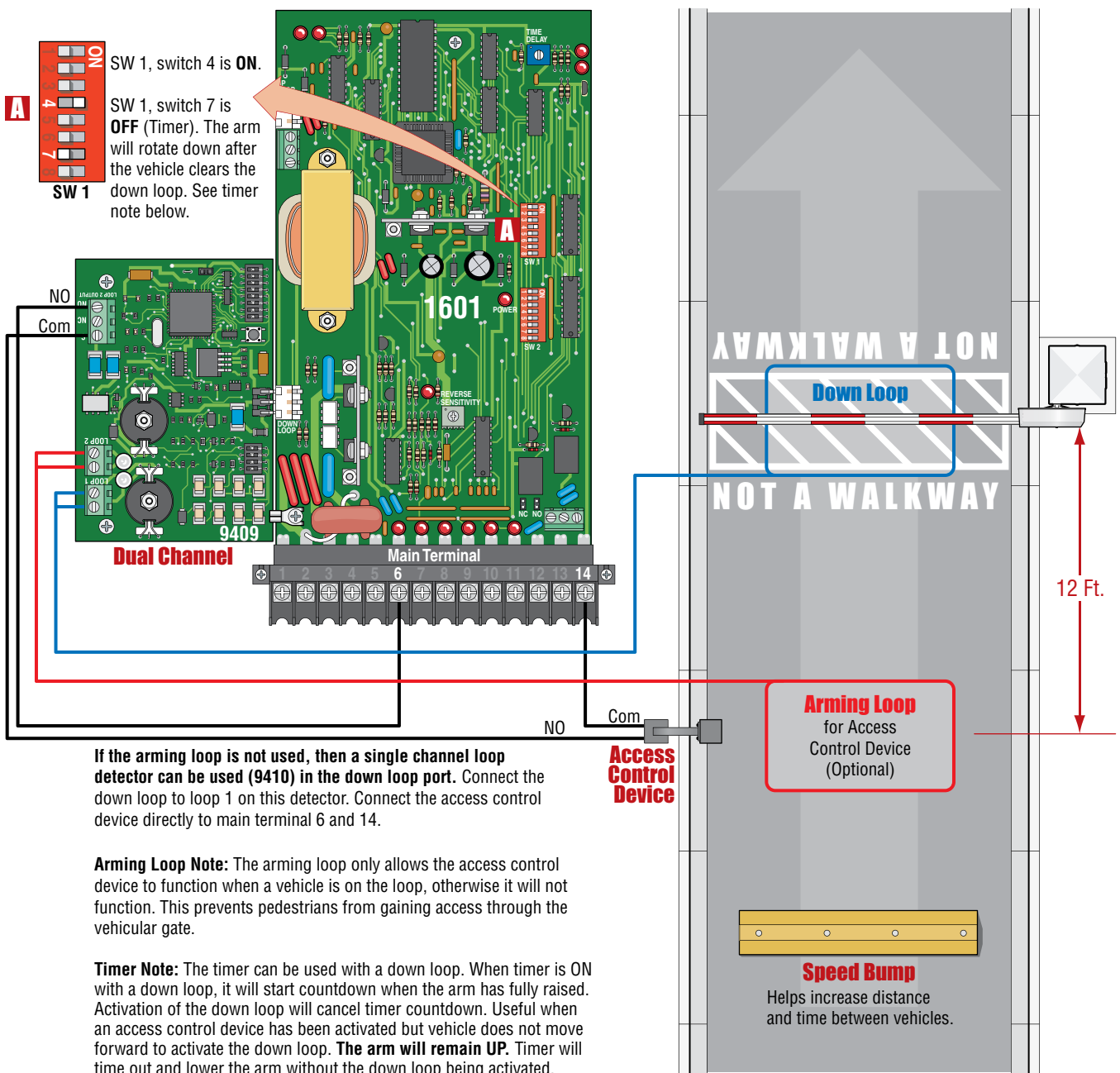

If the arming loop is not used, then a single channel loop detector can be used (9410) in the down loop port. Connect the down loop to loop 1 on this detector. Connect the access control device directly to main terminal 6 and 14.

Arming Loop Note: The arming loop only allows the access control device to function when a vehicle is on the loop, otherwise it will not function. This prevents pedestrians from gaining access through the vehicular gate.

Timer Note: The timer can be used with a down loop. When timer is ON with a down loop, it will start countdown when the arm has fully raised. Activation of the down loop will cancel timer countdown. Useful when an access control device has been activated but vehicle does not move forward to activate the down loop. **The arm will remain UP.** Timer will time out and lower the arm without the down loop being activated.

3.2 Exit Lane Only

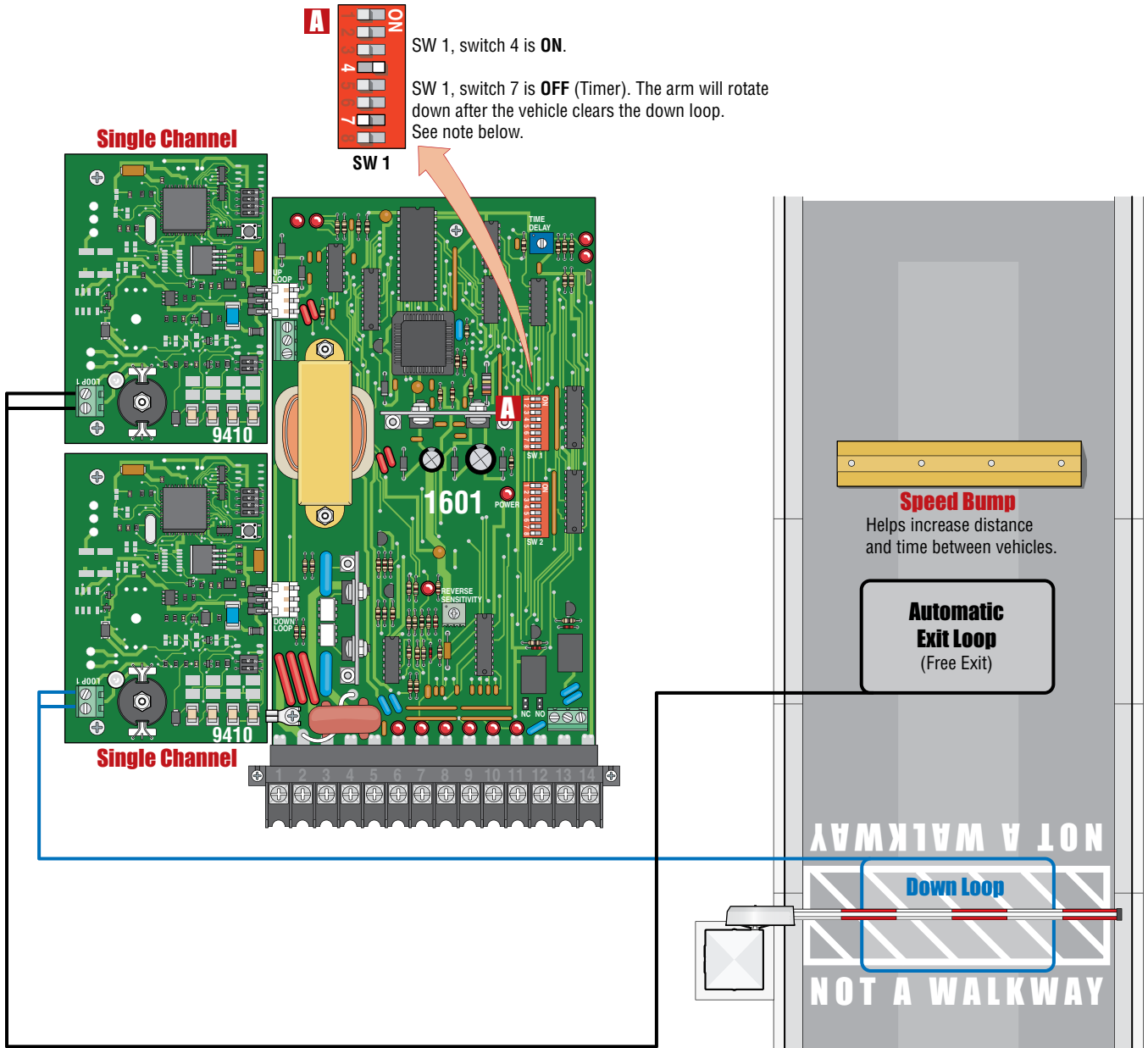

Note: The timer can be used with a down loop. When timer is ON with a down loop, it will start countdown when the arm has fully raised. Activation of the down loop will cancel timer countdown. Useful when the automatic exit loop has been activated but vehicle does not move forward to activate the down loop. **The arm will remain UP.** Timer will time out and lower the arm without the down loop being activated.

3.3 Two-Way Traffic Lane

When a vehicle enters, the down loop will be overridden by the automatic exit loop which will continue to hold the arm up. When the interior down loop has been cleared by the vehicle, the arm will lower.

When a vehicle exits, the automatic exit loop will raise arm and when the down loop is cleared, the arm will lower. The interior down loop is inoperative for exiting vehicles.

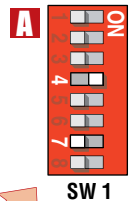

SW 1, switch 4 is ON.
SW 1, switch 7 is OFF (Timer). The arm will rotate down after the vehicle clears the down loops. See timer note below.

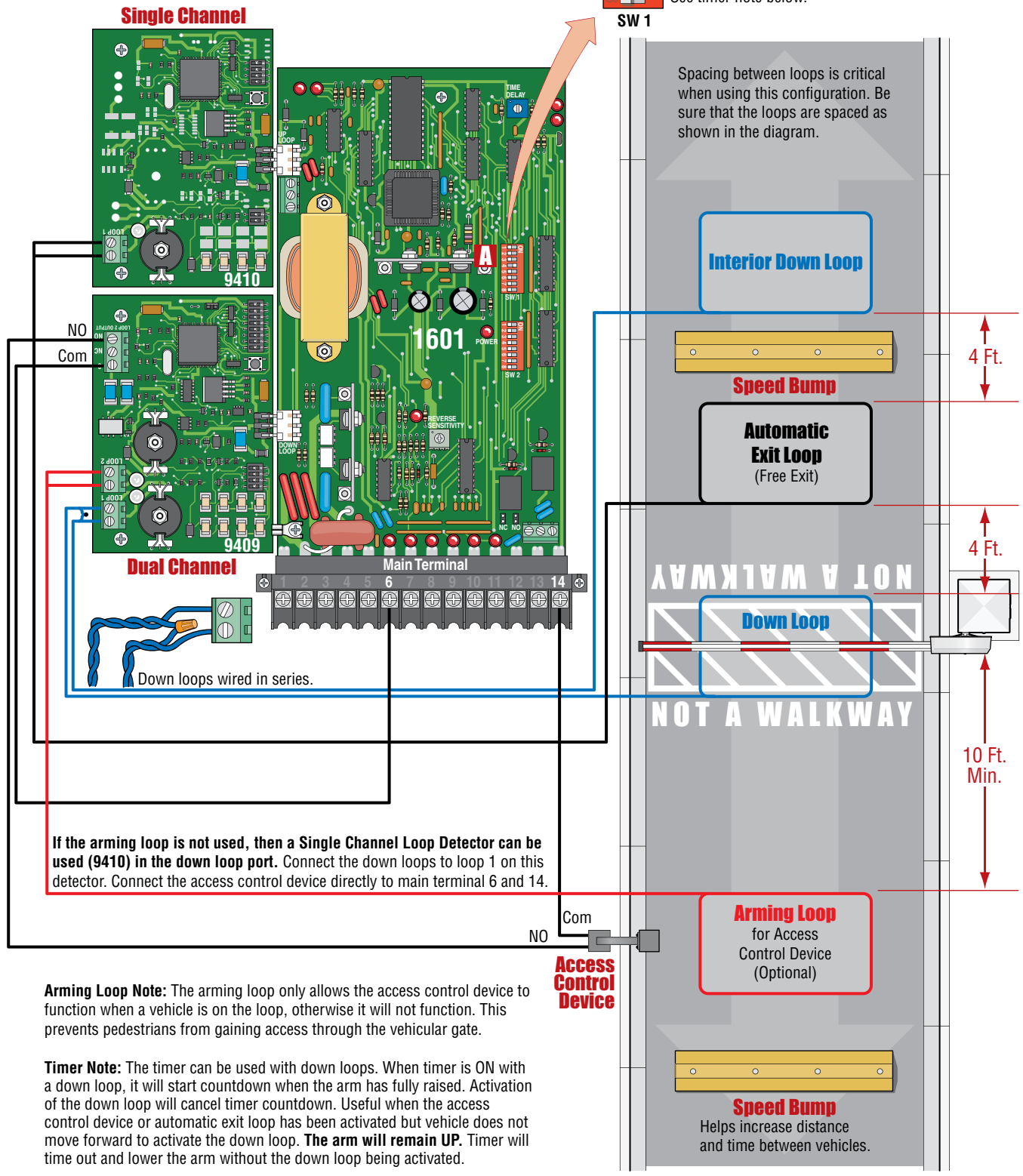

If the arming loop is not used, then a Single Channel Loop Detector can be used (9410) in the down loop port. Connect the down loops to loop 1 on this detector. Connect the access control device directly to main terminal 6 and 14.

Arming Loop Note: The arming loop only allows the access control device to function when a vehicle is on the loop, otherwise it will not function. This prevents pedestrians from gaining access through the vehicular gate.

Timer Note: The timer can be used with down loops. When timer is ON with a down loop, it will start countdown when the arm has fully raised. Activation of the down loop will cancel timer countdown. Useful when the access control device or automatic exit loop has been activated but vehicle does not move forward to activate the down loop. **The arm will remain UP.** Timer will time out and lower the arm without the down loop being activated.

3.4 Ticket Spitter Entry Lane

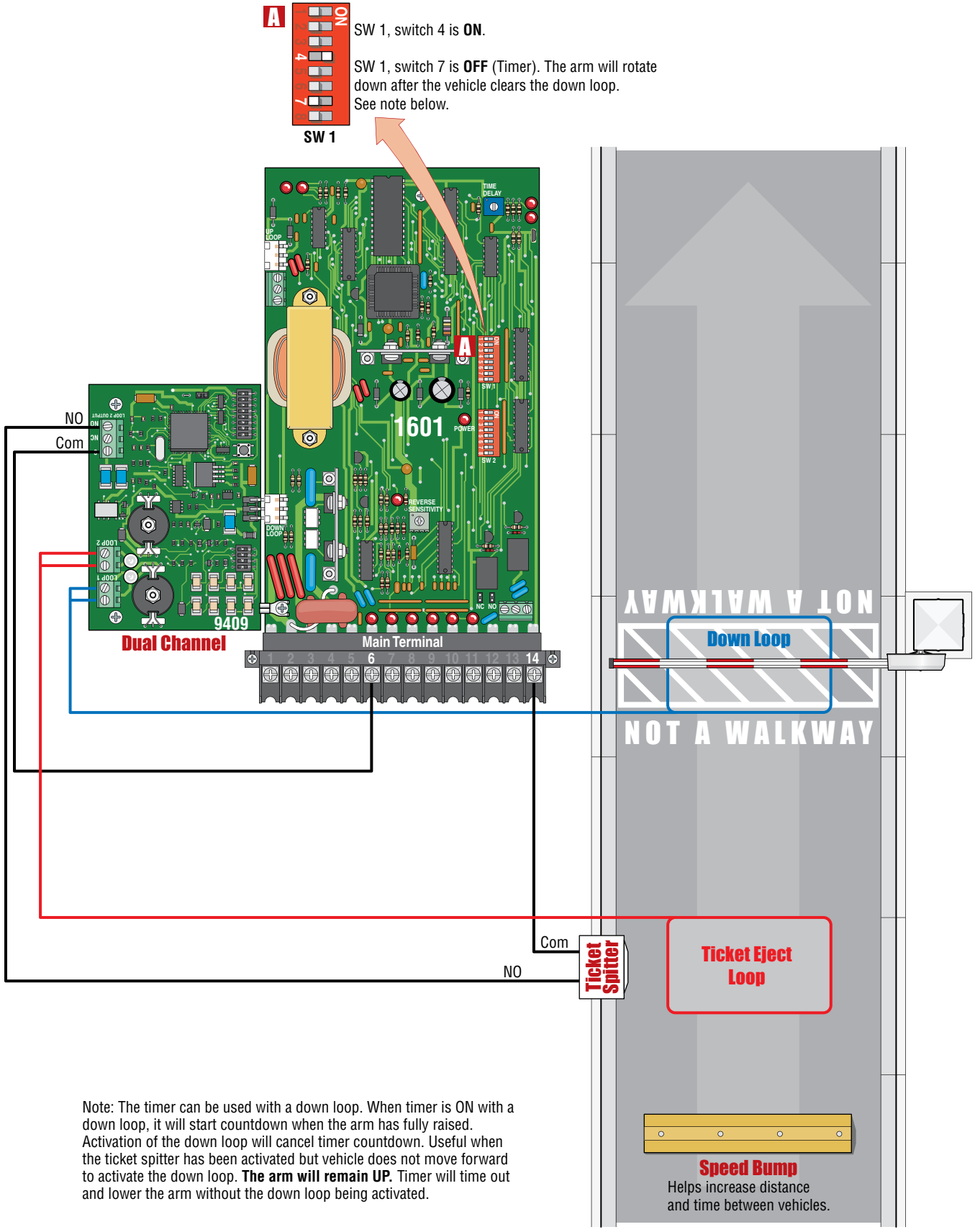

Note: The timer can be used with a down loop. When timer is ON with a down loop, it will start countdown when the arm has fully raised. Activation of the down loop will cancel timer countdown. Useful when the ticket spitter has been activated but vehicle does not move forward to activate the down loop. **The arm will remain UP.** Timer will time out and lower the arm without the down loop being activated.

3.5 Operator Timer ON Entry Lane (No Down Loop)

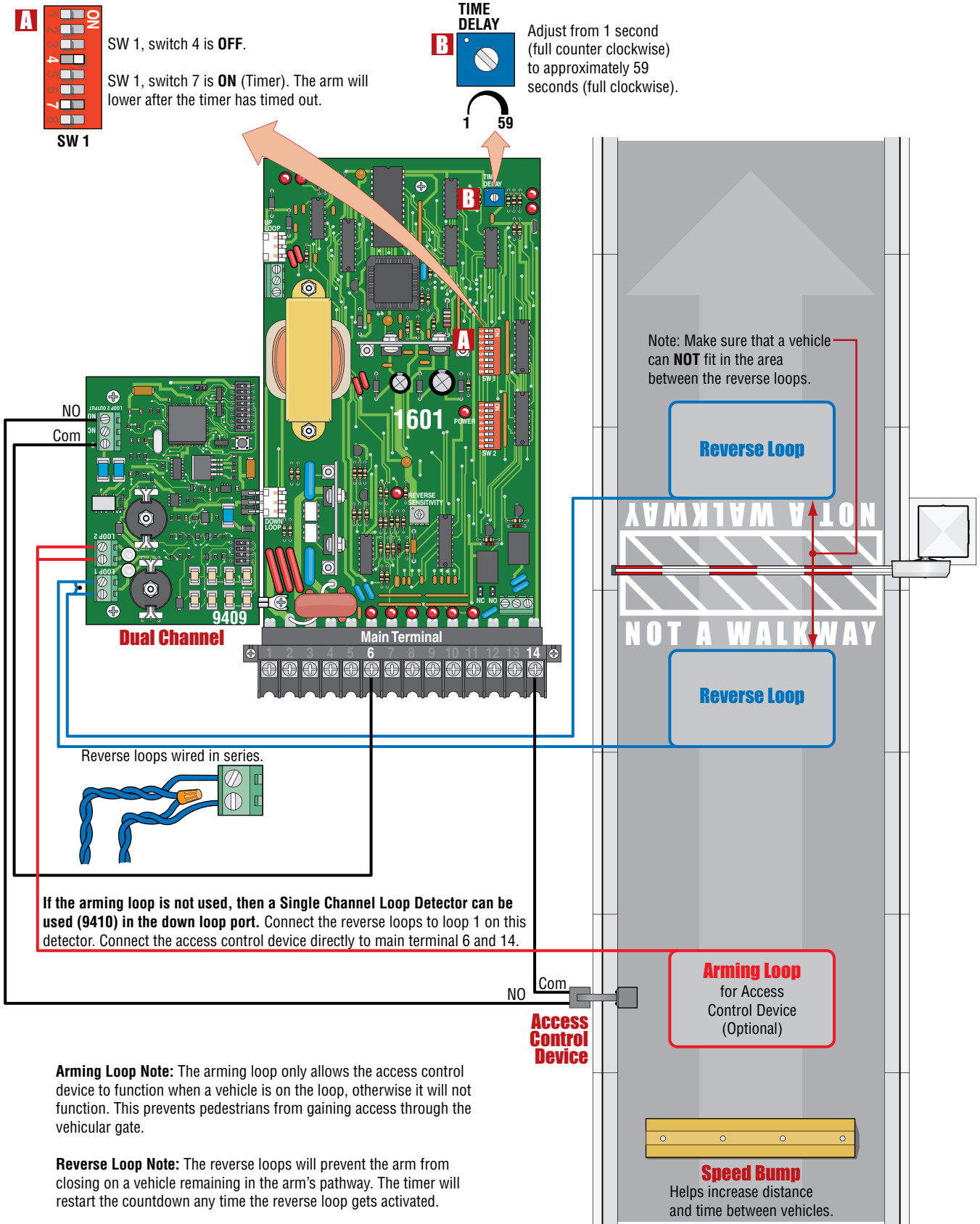

Arming Loop Note: The arming loop only allows the access control device to function when a vehicle is on the loop, otherwise it will not function. This prevents pedestrians from gaining access through the vehicular gate.

Reverse Loop Note: The reverse loops will prevent the arm from closing on a vehicle remaining in the arm's pathway. The timer will restart the countdown any time the reverse loop gets activated.

SECTION 4 - ARM INSTALLATION

Arm installation varies depending on the operator model and individual installation requirements. All operators are equipped with 2 hub connections on opposite sides of the operator.

The 1601 operates with a single 14 ft. arm (either straight or folding arm). The 1601 **can not** operate with the 20 ft. to 27 ft. 3-piece arm assemblies.

The 1602 operator is designed for the 3-piece 20 ft. to 27 ft. arm assemblies only.

4.1 Mounting Hub(s)

Mount hub(s) as shown with operator in the **DOWN** position. A single hub should be mounted on the **SAME** side as oncoming traffic.

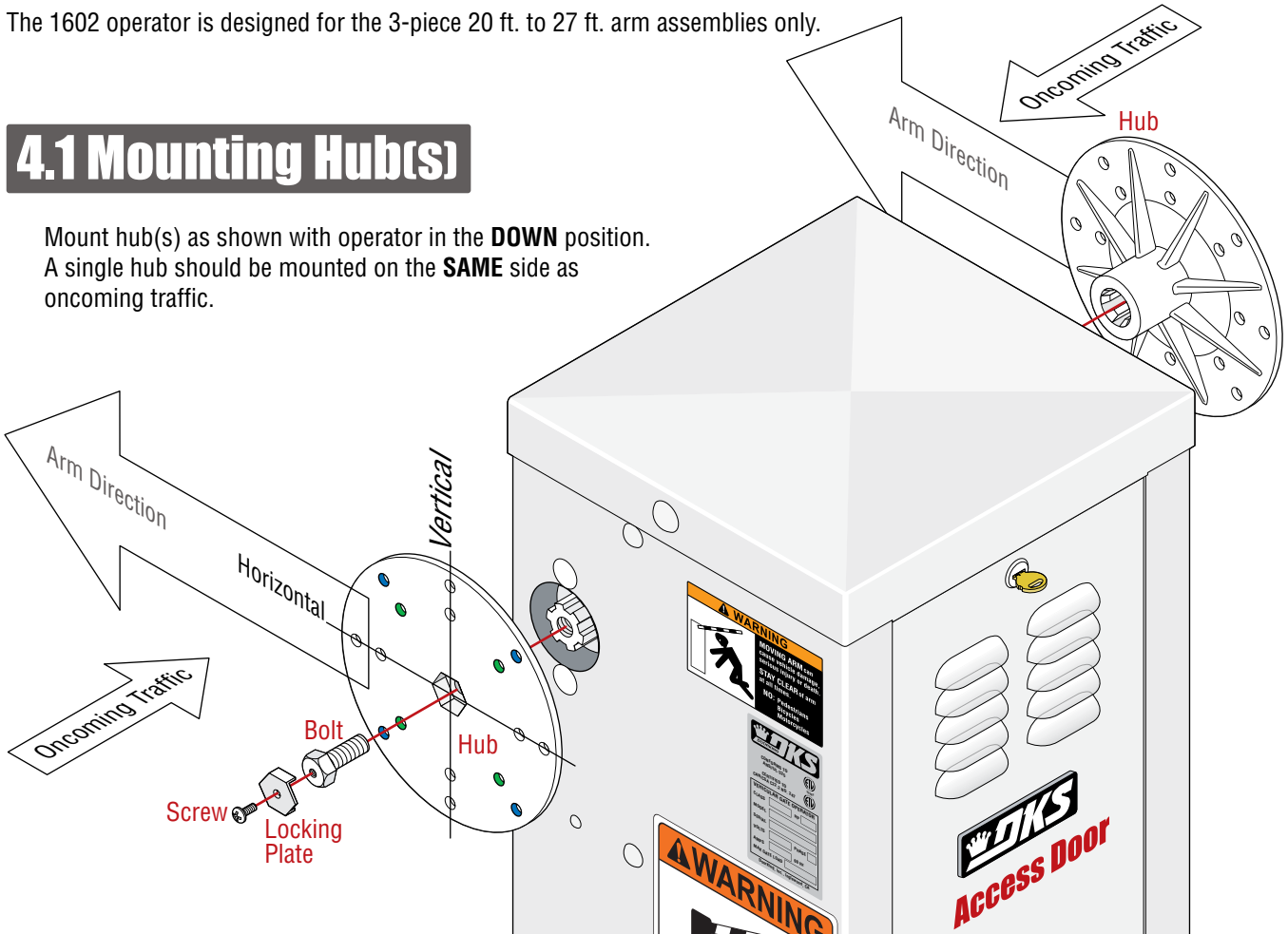

Arm Direction and Bracket Hole Positions

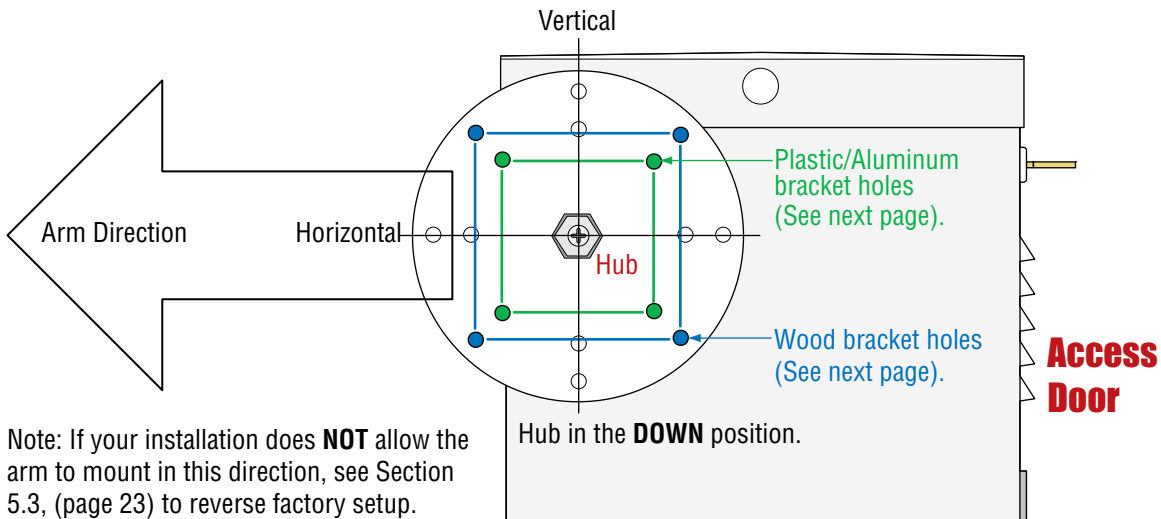

4.2 Mounting Arm(s)

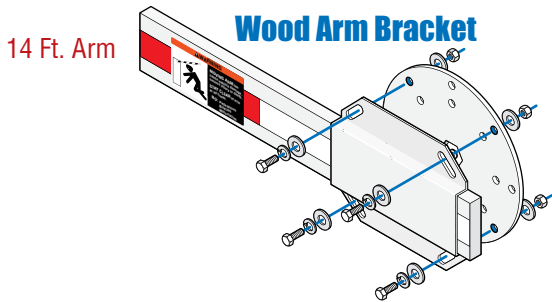

14 Ft. Arm

Wood Arm Bracket

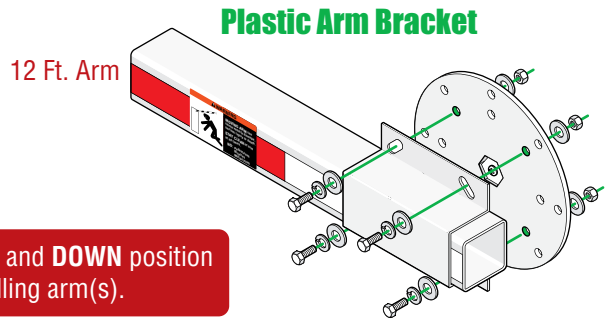

12 Ft. Arm

Plastic Arm Bracket

Test hub **UP** and **DOWN** position before installing arm(s).

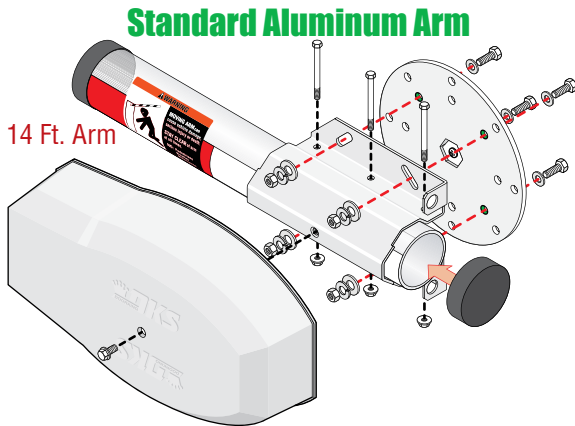

14 Ft. Arm

Standard Aluminum Arm

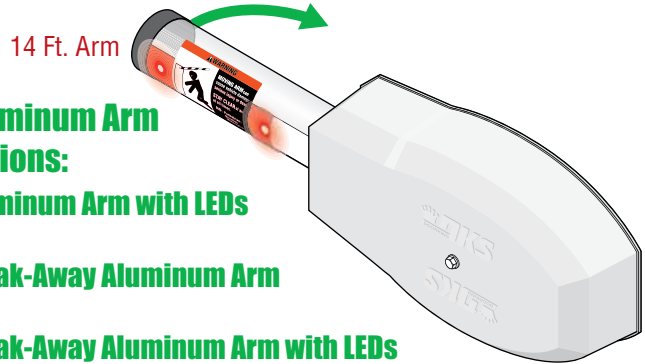

14 Ft. Arm

Aluminum Arm Options:

Aluminum Arm with LEDs

OR

Break-Away Aluminum Arm

OR

Break-Away Aluminum Arm with LEDs

See instruction sheets for mounting optional aluminum arms.

4.3 1602 3-Piece Arm Assemblies

Counter-balance weights are mandatory and **MUST** be installed on any style arm.

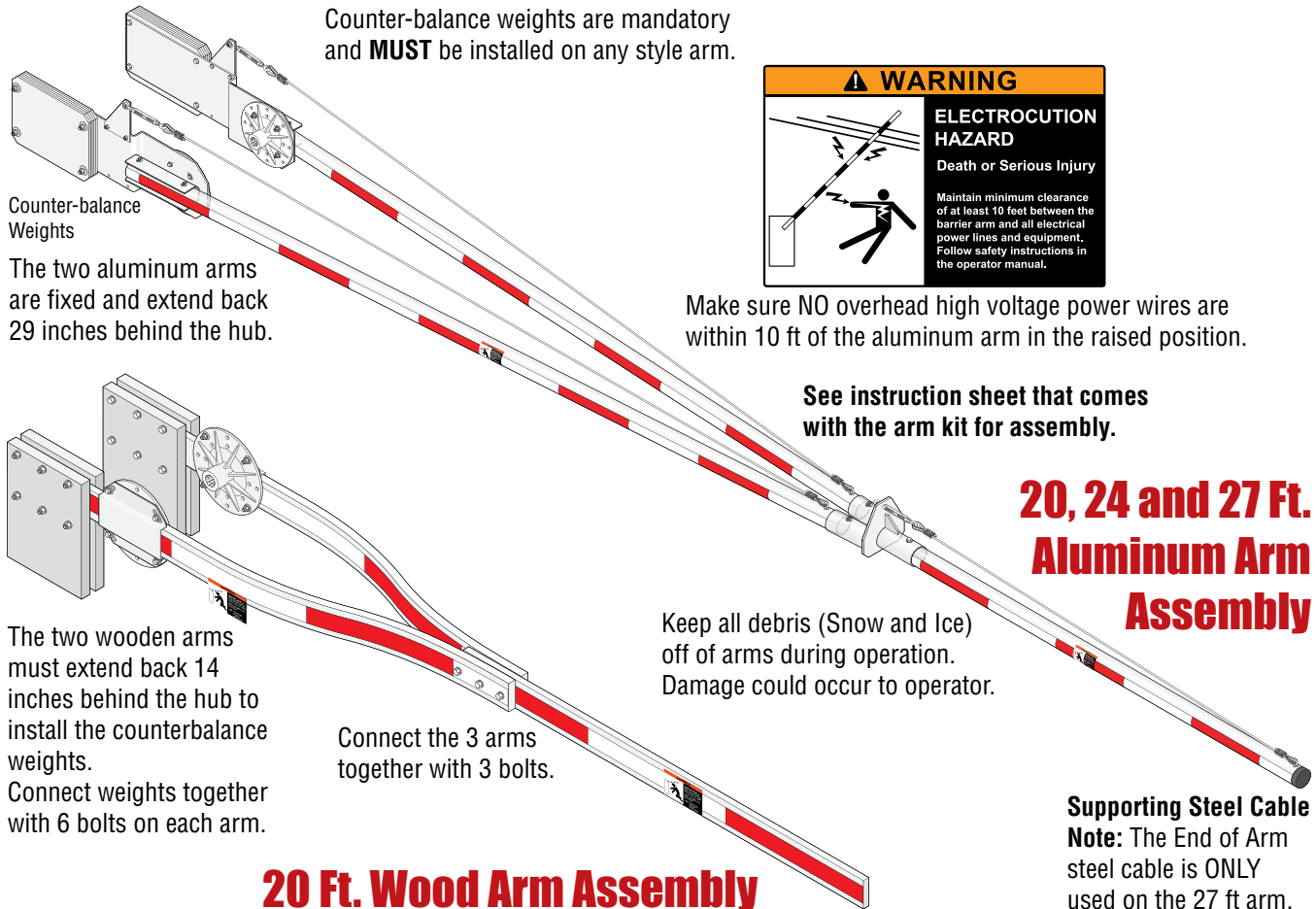

Counter-balance Weights

The two aluminum arms are fixed and extend back 29 inches behind the hub.

The two wooden arms must extend back 14 inches behind the hub to install the counterbalance weights. Connect weights together with 6 bolts on each arm.

Connect the 3 arms together with 3 bolts.

⚠ WARNING	
ELECTROCUTION HAZARD	
Death or Serious Injury	
<small>Maintain minimum clearance of at least 10 feet between the barrier arm and all electrical power lines and equipment. Follow safety instructions in the operator manual.</small>	

Make sure **NO** overhead high voltage power wires are within 10 ft of the aluminum arm in the raised position.

See instruction sheet that comes with the arm kit for assembly.

20, 24 and 27 Ft. Aluminum Arm Assembly

Keep all debris (Snow and Ice) off of arms during operation. Damage could occur to operator.

Supporting Steel Cable Note: The End of Arm steel cable is **ONLY** used on the 27 ft arm.

20 Ft. Wood Arm Assembly

SECTION 5 - ADJUSTMENTS

The switch settings and adjustments in this chapter should be made after your installation and wiring to the operator is complete. **Whenever any of the programming switches on the circuit board are changed, power must be shut-off, and then turned back on for the new setting to take effect.**

5.1 1601 Circuit Board Description and Adjustments

Gate Tracker Activity LED

An automatic sensor system that senses entrapment of a solid object and is incorporated as a permanent and integral part of the operator.

Gate Operator Data Terminal

Operator status reporting; cycle count, shorted inputs, loop detector problems, power interruptions, etc. See page 9.

Auto Close Timer

Auto close timer (when turned on) SW 1, switch 7.

Adjust from 1 second (full counter clockwise) to approximately 59 seconds (full clockwise).



SW 1



1 59

How LEDs Function



Illuminated LEDs Indicates that low voltage power is being applied to the circuit board.

Input LEDs should be OFF and will only illuminate when the input is activated.

Limit LEDs will only illuminate when the respective limit sensor has been activated.

Self Test

Self test (when turned on) SW 1, switch 2.

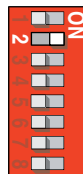

SW 1

DIP-Switches

Set the DIP-switches on the circuit board to the desired setting. See switch settings information on the next 3 pages.

Note: SW 2, switch 1 **MUST** be set for the correct model operator that has been installed.

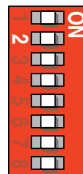

SW 1

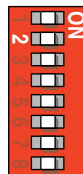

SW 2

Arm Relay Contacts

(C – NC – NO) This relay can be used for a variety of purposes and is typically used to signal when the arm is up or down.

Dry Relay Contact

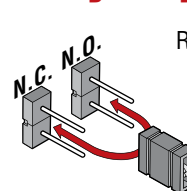

Relay activation is dependant on setting of SW 1, switch 5.



SW 1

Dry relay contacts (terminals 12-13) can be set for Normally Open (NO) or Normally Closed (NC) operation by placing the relay shunting bar on the N.O. or N.C. pins respectively. See page 8 and next page.

Single Channel Loop Detector

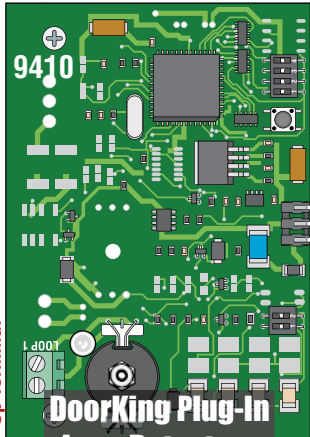

DoorKing Plug-In Loop Detectors

(Sold separately)

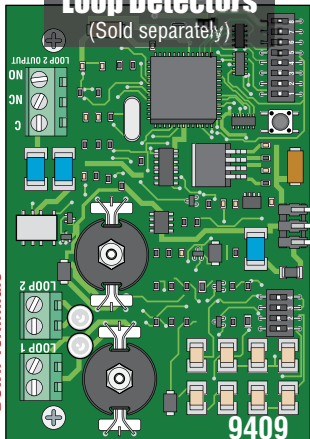

Dual Channel Loop Detector

Reverse Sensor

Adjust reversing sensitivity for the DOWN direction of arm. See page 24.

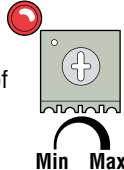

Min Max

Input LEDs Note: The LED that is above the terminal wiring input will light when that terminal input gets activated.

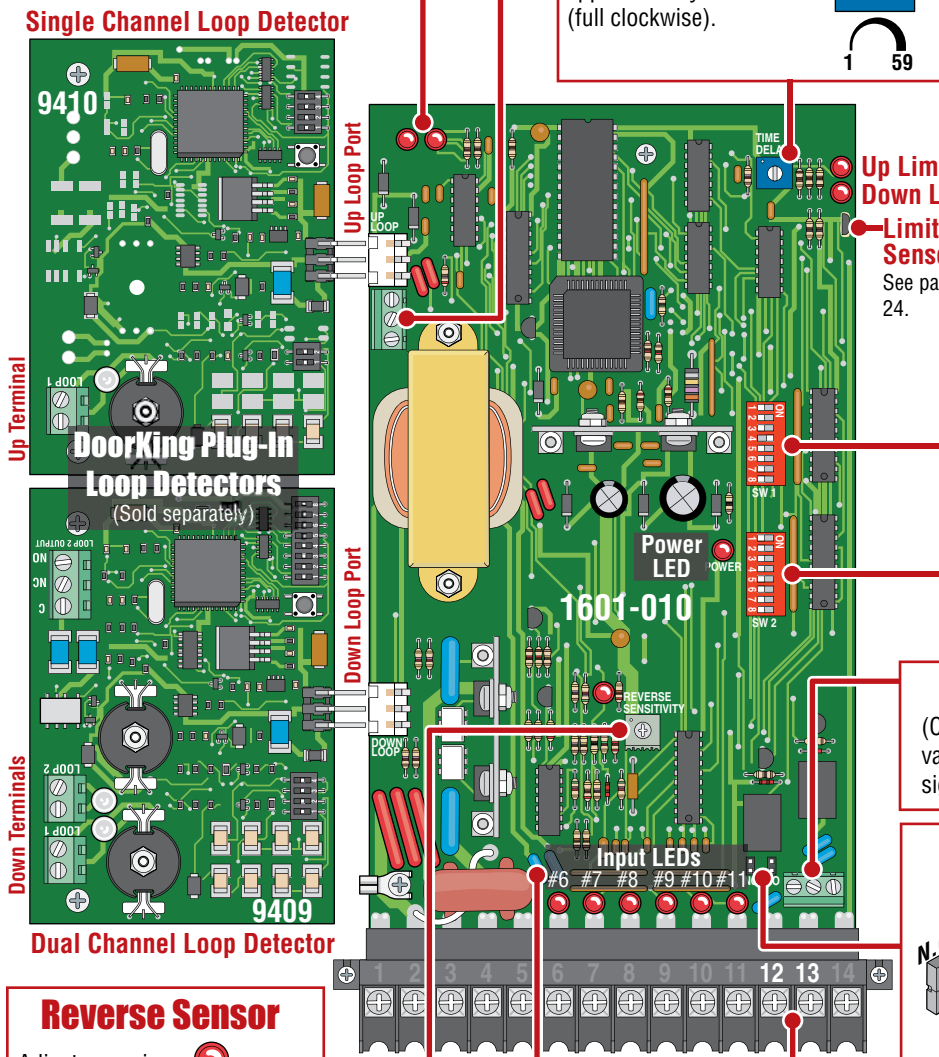

5.2 DIP-Switch SW 1 and SW 2 Settings

The two DIP-switches located on the circuit board are used to program the operator to operate in various modes and to turn on or off various operating features. Whenever a switch setting is changed, power to the operator must be turned OFF and then turned back on for the new setting to take affect. Check and review ALL switch settings prior to applying power to the operator.

SW 1 (Top 8 Switches)			
Switch	Function	Setting	Description
1	Down Active when arm is full up.	OFF	Activation and then deactivation of the down loop or down / reverse input will cause the arm to rotate down ONLY if the deactivation occurred after the arm reached the FULL UP position.
	Down Active when arm is moving up or is up.	ON	Activation and then deactivation of the down loop or down / reverse input will cause the arm to rotate down AFTER reaching the FULL UP position regardless of when the deactivation occurred.
2	Self-Test	OFF	Normal setting. Self-test is turned off.
		ON	Run self-test.
3	Gear Box Travel	OFF	Normal setting. Operator uses 360° of gearbox. Extends wear life of gearbox.
		ON	Operator uses 180° of gearbox. See page 24.
4	Down / Reverse Loop and Input	OFF	Down / Reverse loop and input will function as a REVERSE loop and REVERSE input.
		ON	Normal setting. Down / Reverse loop and input will function as a down input and cause the arm to rotate down upon deactivation of the input. See SW 1, switch 1 for additional information.
5	Relay 1 Activation	OFF	Normal setting. Relay activates when the DOWN loop detector (DoorKing plug-in detector only) senses a vehicle presence.
		ON	Relay activates when the UP loop detector (DoorKing plug-in detector only) senses a vehicle presence.
6	Up Input Function	OFF	Up Input will raise arm and/or reset the down timer. Input will not lower the arm.
		ON	Up Input will raise arm if it is down, or will lower arm if it is up.
7	Timer	OFF	Timer to lower arm is OFF.
		ON	Timer to lower arm is ON. Set from 1 to 59 seconds for close time delay. Timer can be used as a secondary closing command for a down loop. Timer countdown starts when arm has fully raised. Down loop activation will cancel timer and lower arm OR arm will lower when timer has timed out.
8	Up Loop Port Input	OFF	Output of the loop detector plugged into the UP loop port is switched to terminal 7 for connection to other input terminals.
		ON	Normal setting. Output of the loop detector plugged into the UP loop port will raise arm when activated.

SW 2 (Bottom 8 Switches)			
Switch	Function	Setting	Description
1	Model 1601	OFF	Switch must be OFF for model 1601 barrier gate operator.
	Model 1602	ON	Switch must be ON for model 1602 barrier gate operator.
2	Multiple Input Memory ON/OFF Switch	OFF	Normal setting. Operator will respond to a single UP command, then require a DOWN command. Operator will not accept multiple Up commands. Operator will not accept the next UP command until the previous DOWN command is in progress.
		ON	Turns ON the multiple input memory option 1 or 2 (See switch 3). SW 1, switch 4 must also be on.
3	Multiple Input Memory Options (SW2, Switch 2 must be ON) (SW1, Switch 4 must be ON)	Option 1 (OFF Position)	Override a DOWN command – When the arm is in the up position for a vehicle passing through and the next vehicle's UP command is received, the operator will hold the arm up and wait for the next vehicle to clear the down loop before lowering the arm. The operator will not count multiple UP commands. Distance between access control device and barrier operator is a factor when using this option. Remote transmitters recommended for this option. See next page for more information.
		Option 2 (ON Position)	Override Multiple DOWN commands – The operator will count multiple UP commands received during an UP command and require a matching number of DOWN commands before lowering the arm. Distance between access control device and barrier operator is a factor when using this option. Remote transmitters NOT recommended for this option. See page 22 for more information.
4	Stop Arm Function	OFF	Normal setting. Arm will NOT stop DURING the down cycle.
		ON	Stop Arm Function – Arm will stop DURING the down cycle if a vehicle activates the down loop. An UP command will raise the arm, or the arm will continue down AFTER the down loop is cleared.
5	Reverse Delay	OFF	Arm reversal is delayed approximately .5 seconds when a reverse input from terminal 9 is received during the down cycle. (eg. non-contact sensor beam is blocked). Limited application use.
		ON	Normal setting. Instant Reverse – Arm reversal is delayed approximately .1 second when a reverse input from terminal 9 is received during the down cycle. (eg. non-contact sensor beam is blocked)
6	Arm Rotation Direction	OFF	Normal setting. Leave in OFF position.
7	Spare	OFF	Normal setting. Leave in OFF position.
8	Spare	OFF	Normal setting. Leave in OFF position.

Option 1 - Override a DOWN Command **sw2, Switch 3 OFF**

Remote transmitters are recommended for this option.

Basic operator UP/DOWN cycle:
A. Valid **UP** command from the access control device will raise arm.
B. Vehicle activating and clearing the down loop will lower the arm.

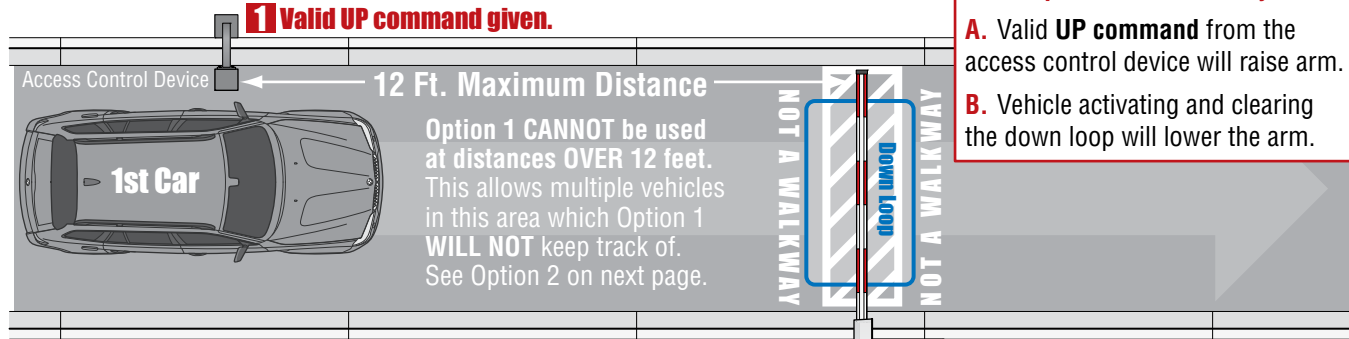

2 Operator will raise arm.

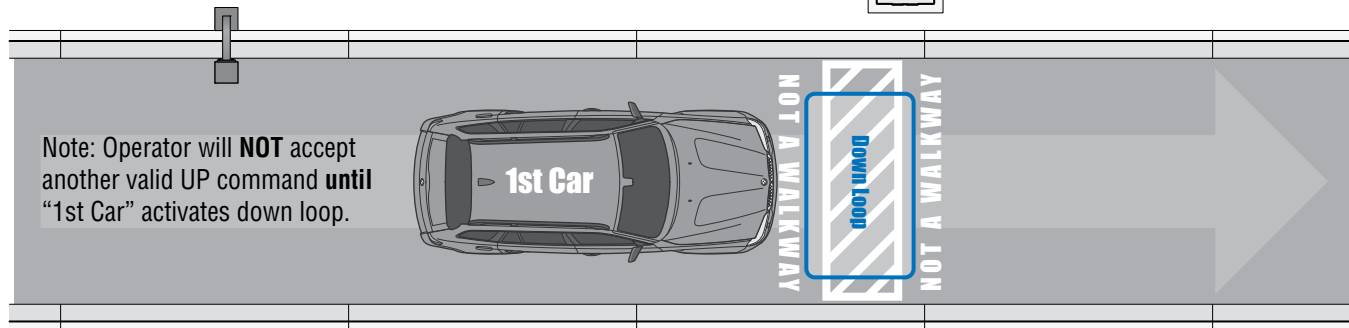

3 1st Car activates down loop.

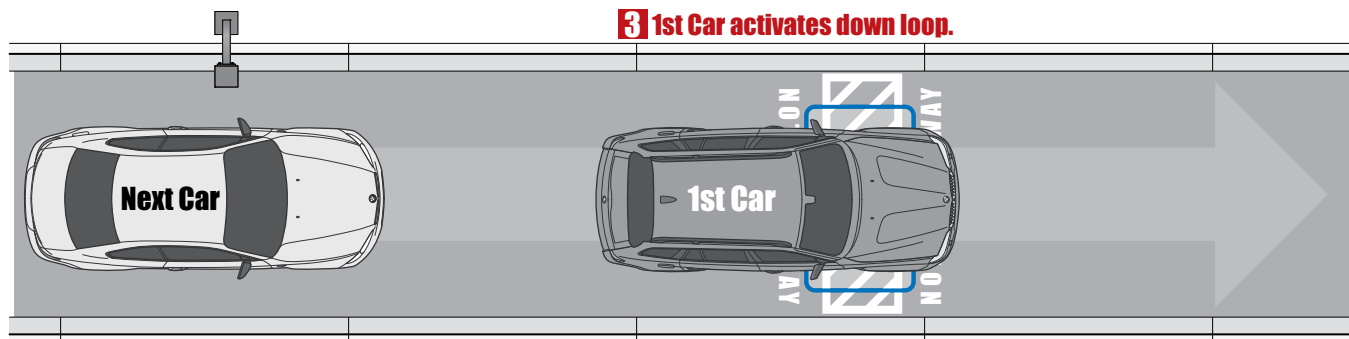

4 While 1st Car is on down loop, the next UP command is given.

5 Operator will override "1st Car's" DOWN command. Arm will remain up and wait for the "Next Car's" down loop to be activated.

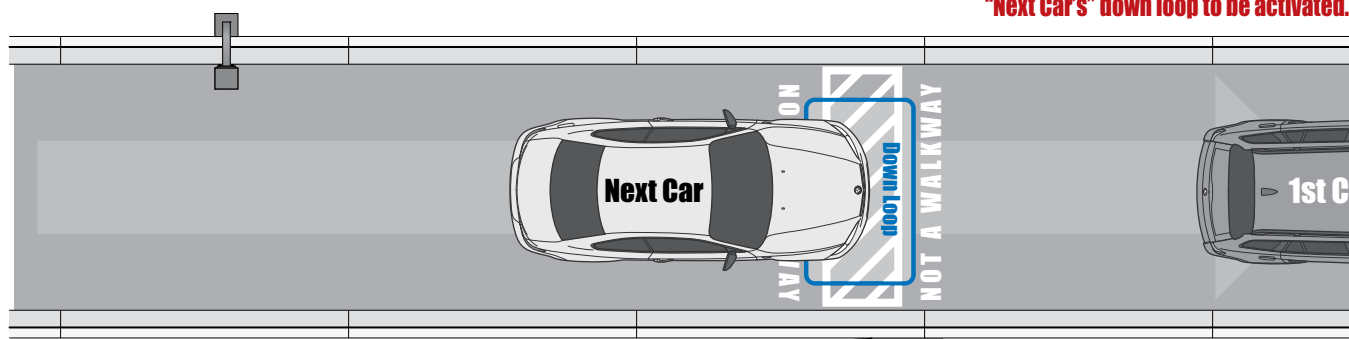

6 When "Next Car" activates then clears down loop, arm will lower.

Note:
 If an UP command is given while the arm is lowering, the arm will raise.

Option 2 - Override Multiple DOWN Commands sw2, switch 3 ON

Basic operator UP/DOWN cycle:

- A.** Valid **UP** command from the access control device will raise arm.
- B.** Vehicle activating and clearing the down loop will lower the arm.

This option allows the access control device and the barrier gate operator to have multiple vehicles in the area between them. The operator will count all the valid UP commands received and require a down loop activation for each one. The arm will lower only after the last vehicle activates then clears the down loop.

Remote transmitters are **NOT** recommended for this option because **one vehicle's remote** can accidentally be pressed **multiple times** which will get counted by the operator as multiple vehicles.

Note:
If a valid UP command is given while the arm is lowering, the arm will raise.

1 Valid UP command given

Access Control Device

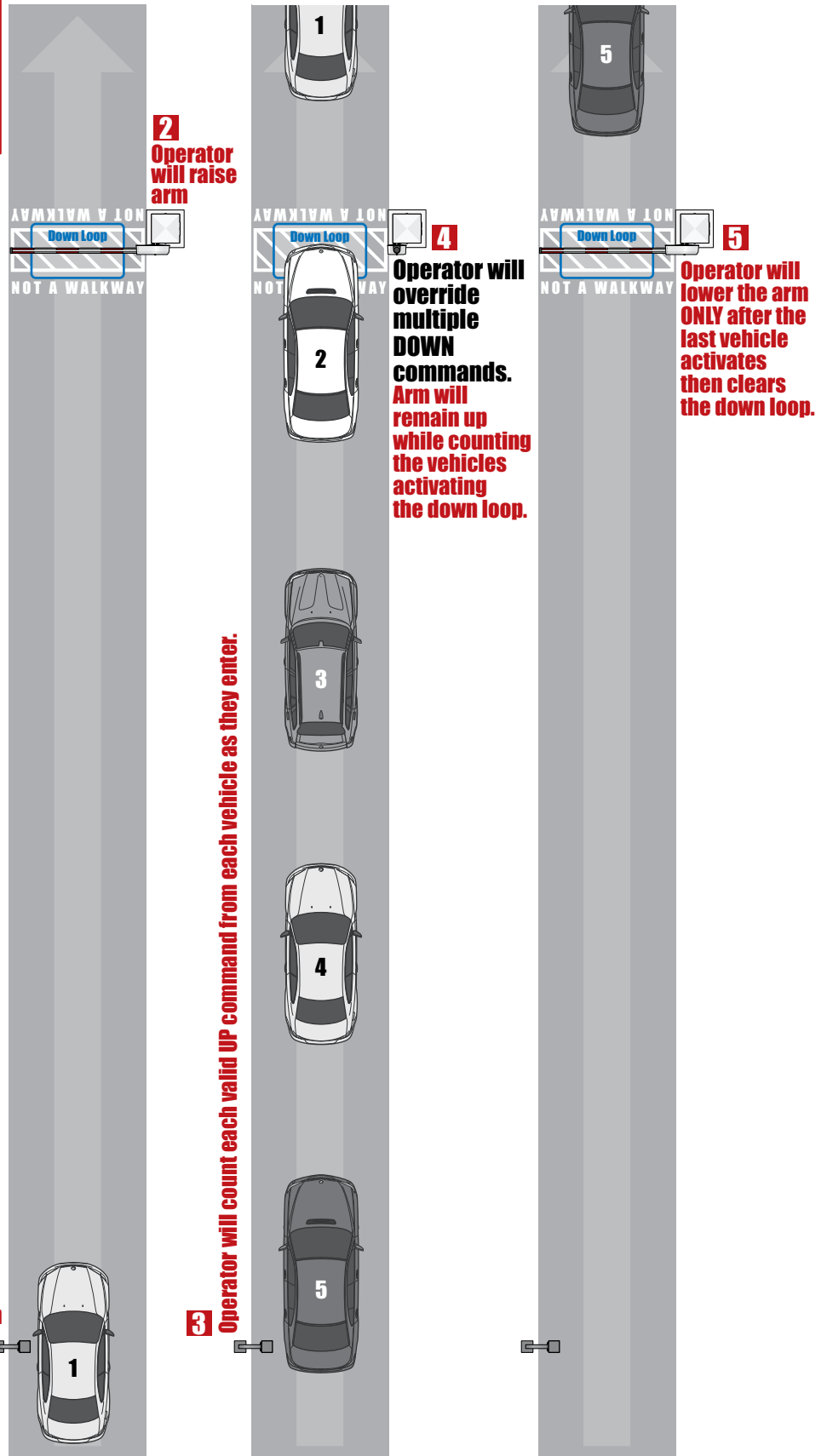

5.3 Reverse Arm UP and DOWN Positions

The operator has been setup from the factory to have the access door opposite the traffic lane.

If the operator has been installed with the access door facing the traffic lane, the arm will operate in the **reverse** direction from the factory setup. The UP and DOWN magnet positions must be reversed on the limit plate.

Operators equipped with the convenience open system must adjust the DC limit assembly (See below).

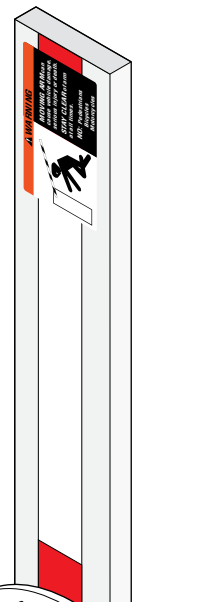
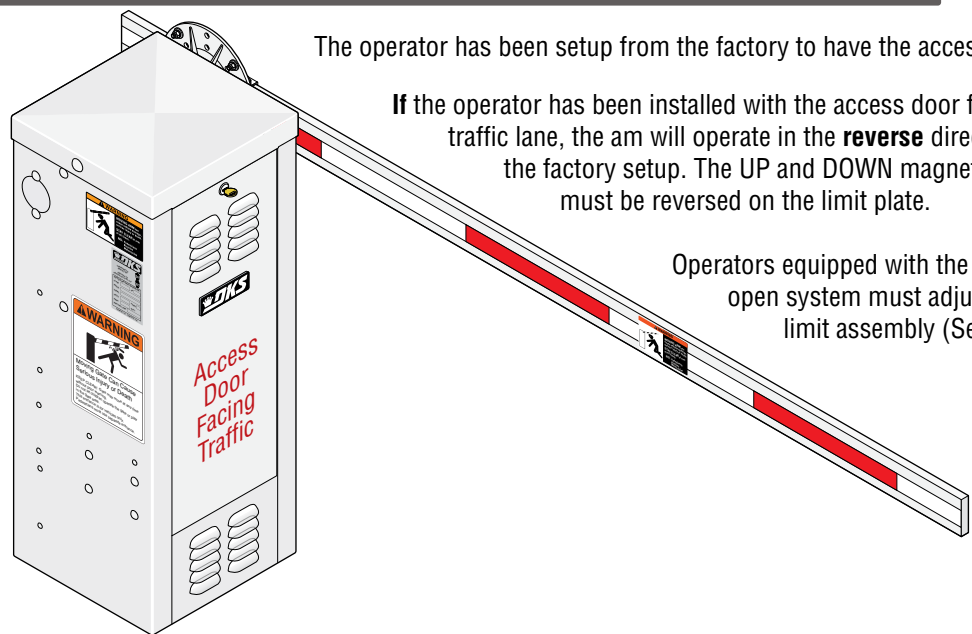

Note: Magnets can be removed from assemblies with 3 screws and flipped over to show or hide the white dot.

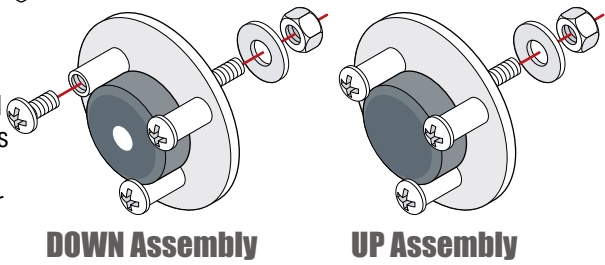

Magnetic Limit Assemblies

Reverse the positions of the magnets on the limit plate. The white dot will be visible on the **DOWN** assembly magnet **ONLY**.

Be careful when reversing assemblies not to damage circuit board.

UP Position of Limit Plate

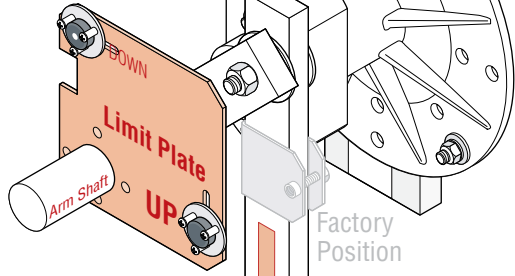

DC Limit Assembly

DC Limit Sensor

DOWN Position of Limit Plate

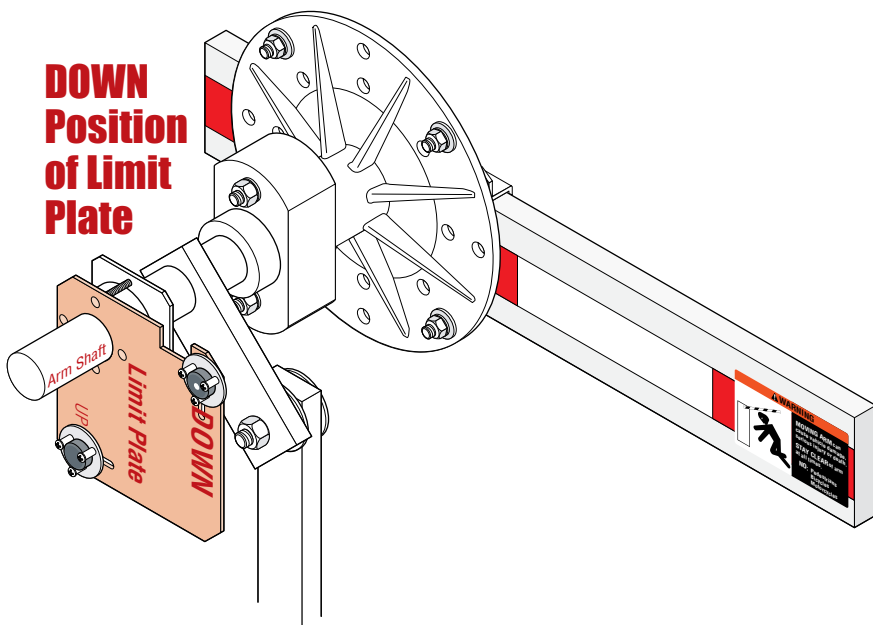

Convenience Open System

Slide the DC limit assembly down the linking arm to align with the DC limit sensor when the arm is in the **UP** position.

Note: DC limit sensor is used to hold the arm in the UP position during an AC power failure.

5.4 Magnetic Limit Adjustments

The operator has been preset at the factory to rotate 90°. **No adjustments are necessary when used in a normal 90° setup.**

If the arm needs to rotate less than 90°:

- 1** Turn operator power **OFF**.
- 2** Set the DIP-switch SW 1, switch 3 to **ON**. This changes the rotation of the gearbox from 360° to 180° allowing the gearbox to rotate the arm less than 90°.
Note: The arm will **always** cycle to 90° open with the 360° gearbox setting.

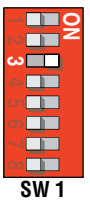

- 3** Loosen magnet limit assembly nuts and slide the assemblies to the desired **UP** and **DOWN** positions. Tighten nuts when desired positions are achieved.

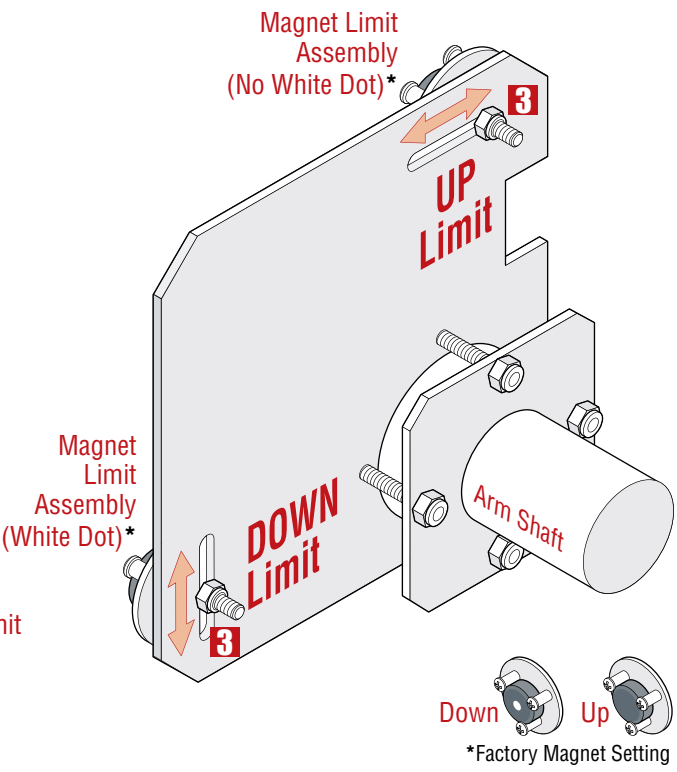
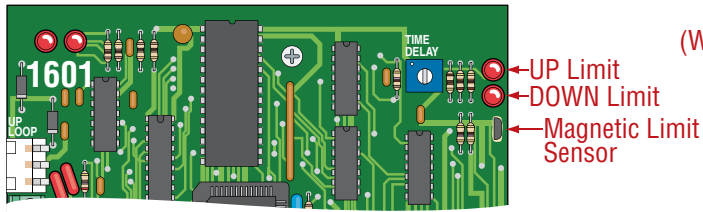

5.5 Reverse Sensor

Reverse sensitivity adjustment will cause the barrier arm to reverse direction of travel should an object be encountered during the down cycle. The amount of force required for the arm to reverse direction depends on the reverse sensitivity potentiometer. **CAUTION: Keep pedestrians and vehicles clear of the arm zone while adjusting sensor!**

While operator has AC power:

- 1** Turn control switch to **UP**. Arm will rotate UP.
- 2** Turn control switch to **DOWN**. While arm is traveling down, rotate reverse sensor clockwise until the **reverse LED lights up** and the arm reverses direction. Rotate reverse sensor back counterclockwise approximately 1/8 turn.
- 3** Repeat the adjustment as needed to find a satisfactory setting.

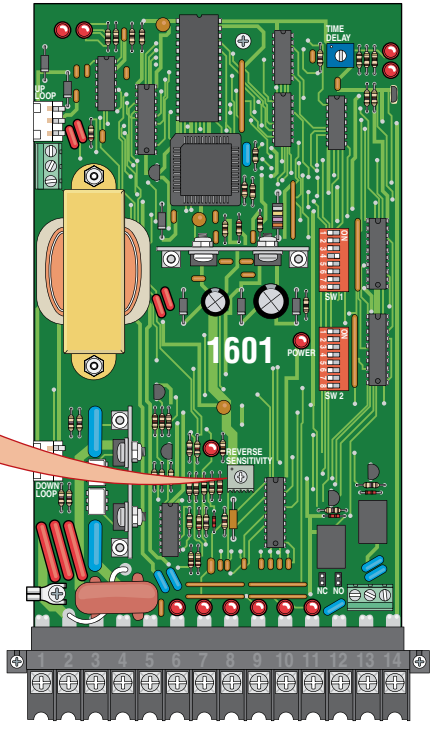
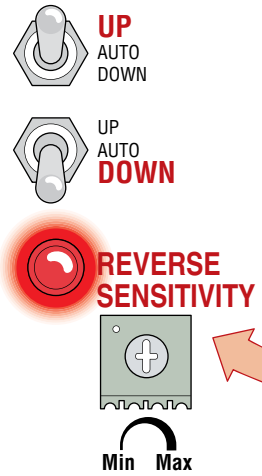

5.6 Manual Operation of the Arm

When a power failure occurs in an operator **WITHOUT** the convenience open feature with the arm (3-piece arm for the 1602) in the down position and the pathway needs to be open, **the arm MUST be unbolted from the hub with 4 bolts and removed to clear the pathway.** A manual release kit is offered from DoorKing to physically crank the arm up if desired (See below).

Operators **WITH** the convenience open feature can be set to automatically open the arm(s) during a power failure.

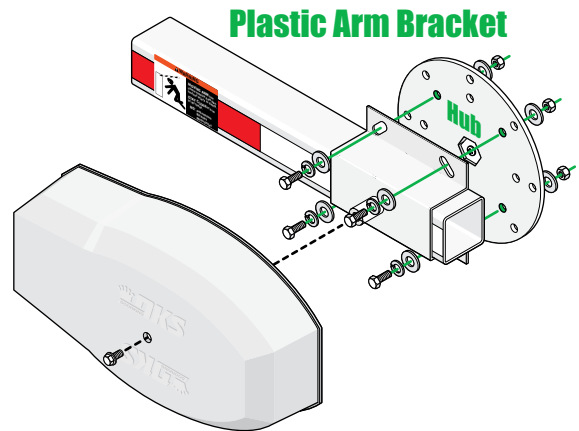
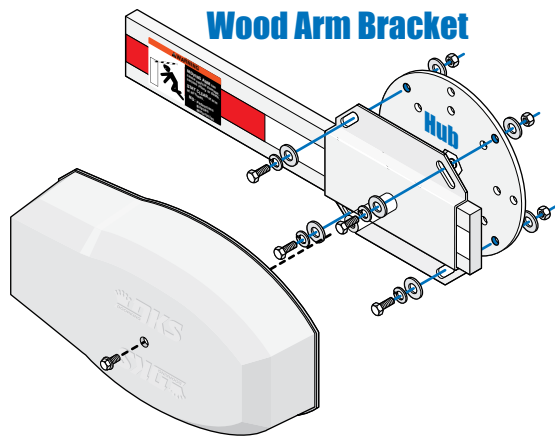

Standard Aluminum Arm or Lighted Arm

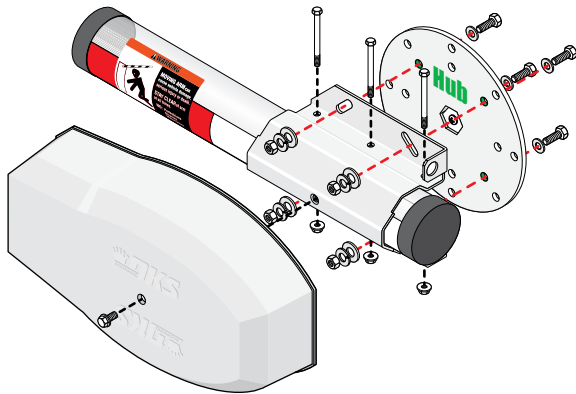

Lighted Arm Note: Unplug wire harness and remove from operator housing **BEFORE** unbolting arm from hub.

Break-Away Aluminum Arm

Note: Unplug wire harness and remove from operator housing **BEFORE** unbolting arm from hub.

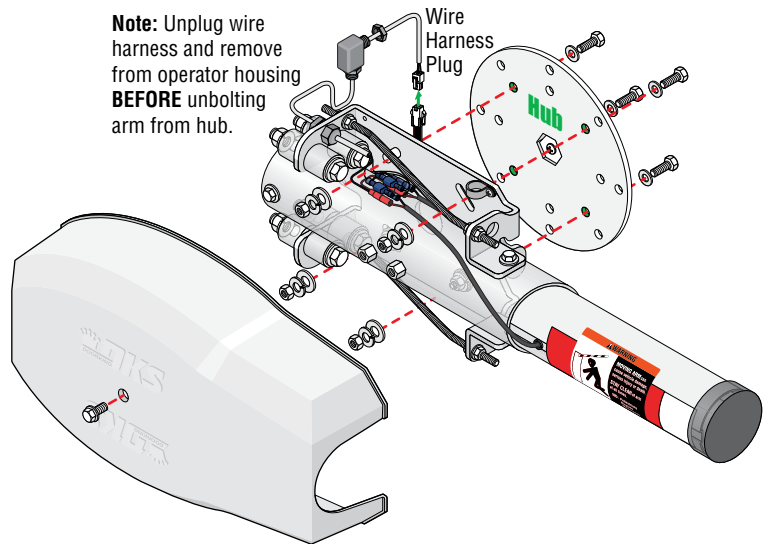

“Optional” Manual Release Kit

DoorKing offers a kit designed to be installed on the 1601 or 1602 barrier gate operators **WITHOUT** the convenience open feature. It provides a crank tool to manually move the arm up or down. **DO NOT install on convenience open models.** For further information about this kit, refer to the instruction sheet provided with the kit (P/N 1601-270) or go to DoorKing’s technical web site at: www.dkaccess.com.

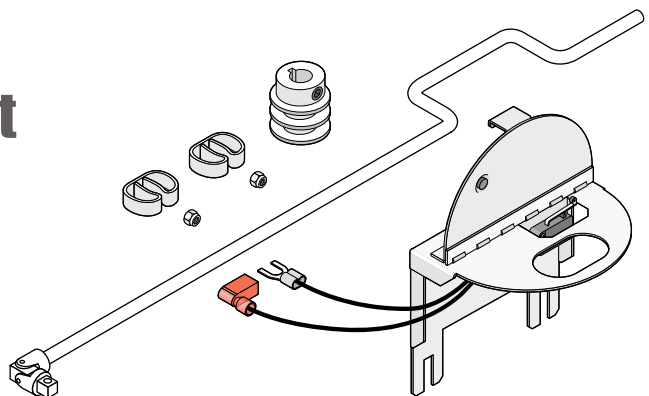

SECTION 6 - OPTIONAL CONVENIENCE OPEN SYSTEM

The optional convenience open system installed in your vehicular gate operator is designed as a convenience enhancement only. It is not designed or intended to provide continuous gate operation during a power outage. Its sole purpose is to provide a method to open the vehicular gate to allow unimpeded traffic flow when the gate and access control system is without power. If your access control system requires 100% power backup and continuous operation when primary (AC) power has failed, a power inverter / backup system, such as DoorKing's Model 1000 is required.

- The convenience open system **cannot** provide continuous gate operation during a power outage.
- **This system cycles the arm to the open position one time only after AC power failure.**
- The convenience open system requires testing on a monthly basis to insure the batteries are fully charged and that the system is operational.
- The convenience open system uses two 12-volt, 3.0 amp-hour gel-cell batteries. These batteries should be replaced every two years on average, or sooner if required.
- Batteries are affected by temperature. Cold temperatures will reduce the effectiveness of the batteries. High temperatures will result in a shortened battery life.
- Batteries are not covered under warranty.

6.1 Circuit Board Settings and Descriptions

This convenience open system consist of a control board (1473-010), motor and power supply (batteries) providing a completely redundant drive system to open the barrier arm should a power outage occur. This system is not designed to maintain continuous barrier operation; rather it provides a convenient method to open the arm **once** during adverse conditions. **If continuous barrier and access control system operation is required, refer to the DoorKing Model 1000 Inverter / Backup Power System.**

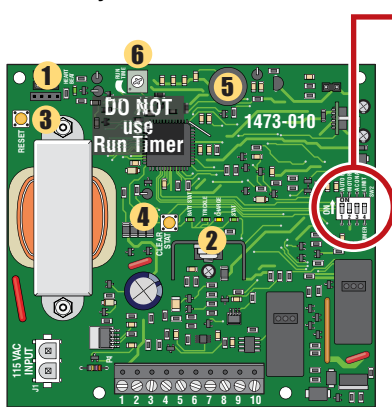

DIP-Switches

Switch	Function	Setting	Description
1	Auto Open Operation After Power Outage	OFF	DO NOT USE. Manual Mode.
		ON	(Auto Mode) Apartment complexes, gated communities, etc.: Arm will automatically raise to the operator's UP limit position.
2	Motor Dir Motor Direction	OFF	Set so that the arm opens to the UP direction upon loss of AC power.
3	AC on ACT Restore Power Operation	OFF	DO NOT USE. Physical Input Required.
		ON	Auto: a 1-second pulse is automatically sent to the barrier gate operator input to restore normal operation again.
4	Timer-OFF Limit-ON Operator Type	Timer-OFF	DO NOT USE. "Run timer" is used and MUST be adjusted.
		Limit-ON	Operator limits are used to stop arm at UP position.

1 HEART BEAT LED

Blinking: Indicates board is operating normally.

2 Battery LEDs

BATT STAT LED

2 Blinks: Replace batteries.

3 Blinks: Battery level is too low.

4 Blinks: Batteries are not connected.

5 Blinks: Bad battery.

6 Blinks: Battery charge current exceeds maximum, possible shorted cell.

TRICKLE LED

Steady Green LED: Battery is fully charged and a trickle charge is being used to maintain a full charge.

CHARGE LED

Steady Yellow LED: Battery is being bulk charged.

Blinking Yellow LED: Battery is 90% of a full charge.

STAT LED

3 Blinks: Extreme temperature, charging suspended.

3 Reset Button

Press to reset board.

4 Clear Stat Button

Press and hold the **CLEAR STAT** button for 4 secs clears the battery replacement reminder counter and resets the beeper. LEDs will also indicate battery status.

5 Beeper

A beep every 20 seconds indicates that battery replacement is needed. Press and hold the **CLEAR STAT** button to reset the battery reminder beeper and clear the counter. LEDs will also indicate battery status.

6 Run Timer DO NOT USE.

Operating Note: Arm will cycle to UP position **automatically** (DIP-Switch 1 **ON**) during an AC power failure. Operator's DC limit sensor will stop and hold the arm in the UP position (DIP-Switch 4 **ON**). Operator will **automatically** return to normal operation once AC power has been restored (DIP-Switch 3 **ON**).

Initial Power Up Convenience Open Note: The DC power is not present on the main circuit board until the **first** initial cycle.

6.2 DC System Wire Schematic

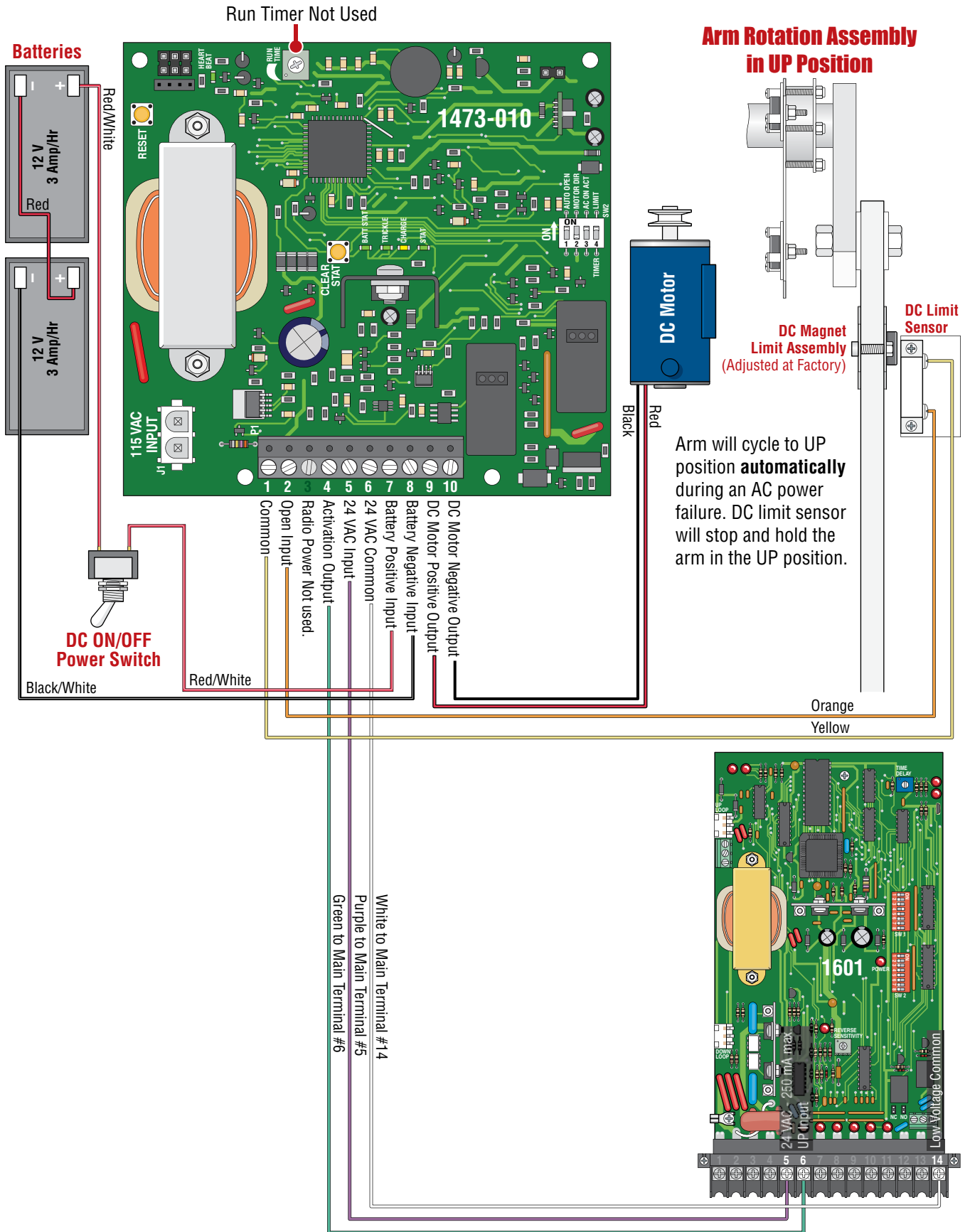

SECTION 7 - OPTIONAL ACCESSORIES INSTALLATION

7.1 Contact Sensor (Reversing Edge)

In addition to the electronic reversing device (ERD) an optional electric reversing edge may be installed offering additional protection to the arm, operator and obstruction. Available from DoorKing to fit all arm lengths.

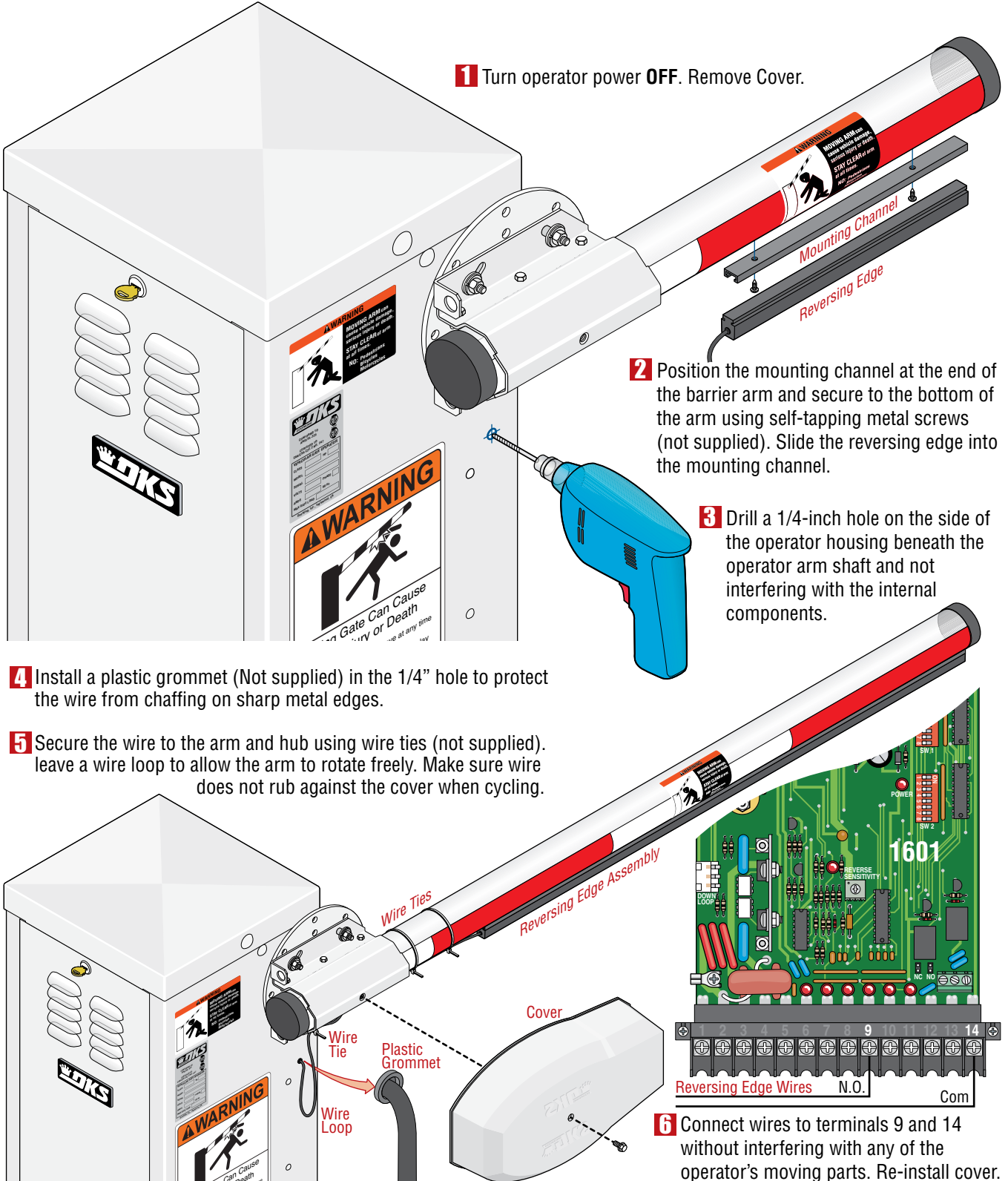

7.2 Fan Kit

An optional fan kit (P/N 1601-093) is recommended in hot humid climates to prevent heat and moisture build-up inside the housing.

- 1 Shut off AC power to operator.
Turn off DC power switch on certain models.

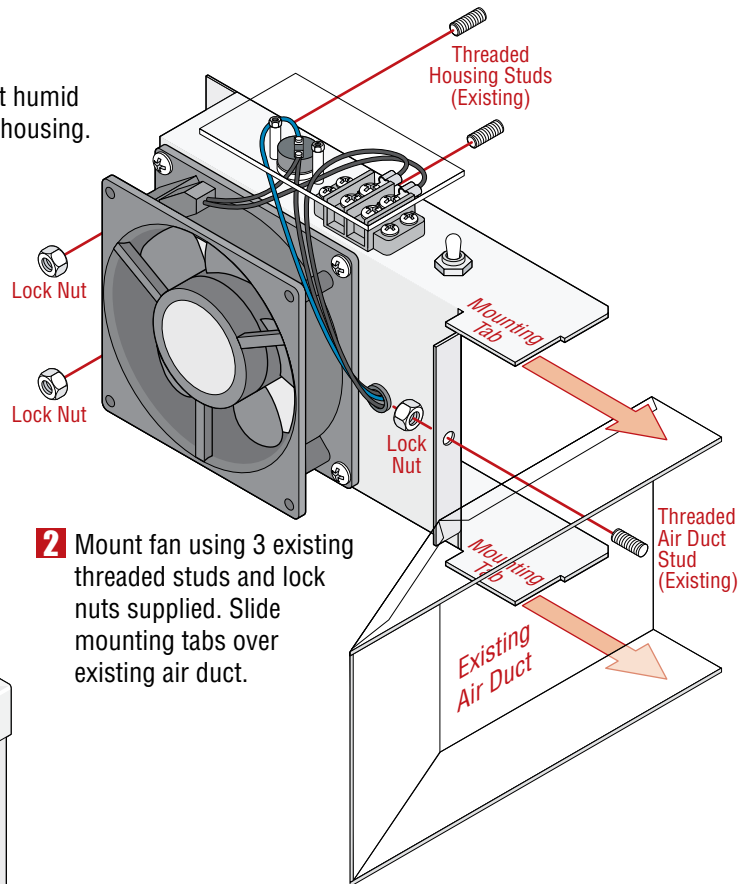

- 2 Mount fan using 3 existing threaded studs and lock nuts supplied. Slide mounting tabs over existing air duct.

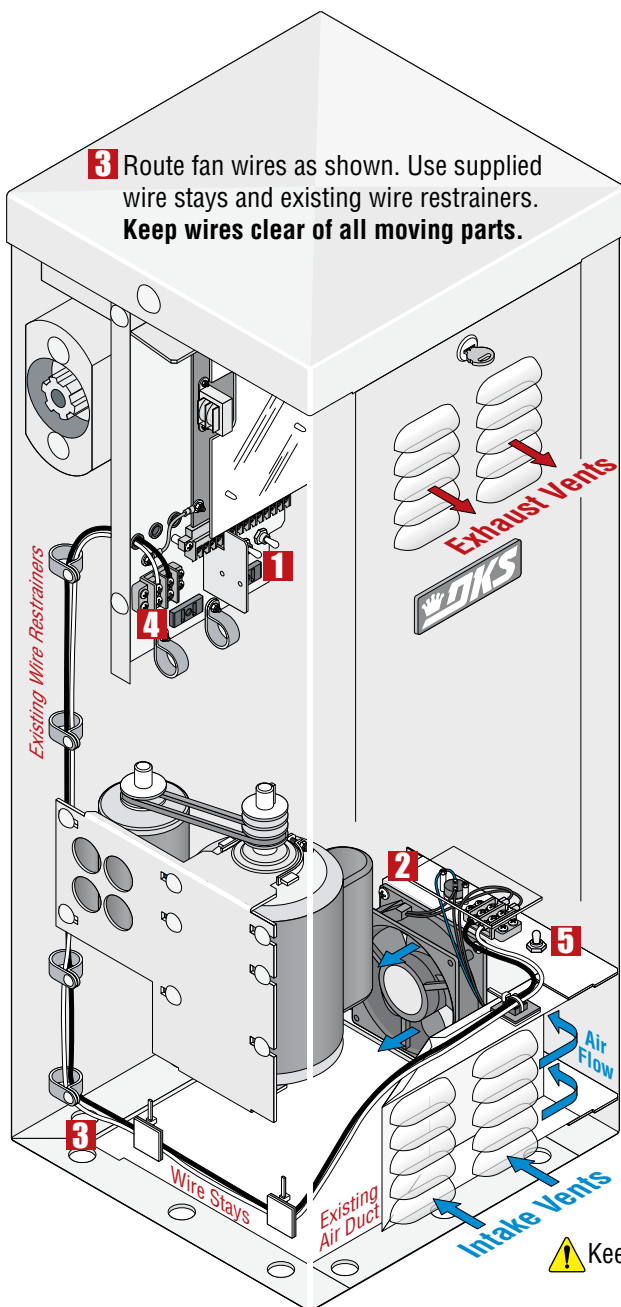

- 3 Route fan wires as shown. Use supplied wire stays and existing wire restrainers. **Keep wires clear of all moving parts.**

- 4 Connect the fan power wires.

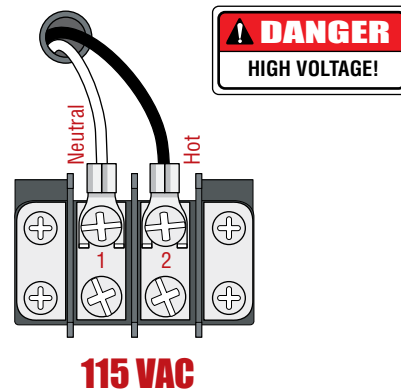

- 5 Fan switch settings.



ON - Turns the fan on continuously.

OFF - Turns the fan off.

AUTO - Normal setting. Automatically turns the fan **ON** when the temperature rises above 90°F inside the housing, and turns the fan **OFF** when the temperature drops below 90°F.

Keep intake vents clear of debris.

7.3 Heater Kit

To avoid the gearbox oil from freezing an optional heater kit (115 VAC - P/N 1601-092) is recommended in areas where temperatures routinely drop below 40°F (4°C).

- 1** Shut off AC power to operator.
Turn off DC power switch on certain models.

- 3** Route heater wires as shown. Use supplied wire stays and existing wire restrainers.
Keep wires clear of all moving parts.

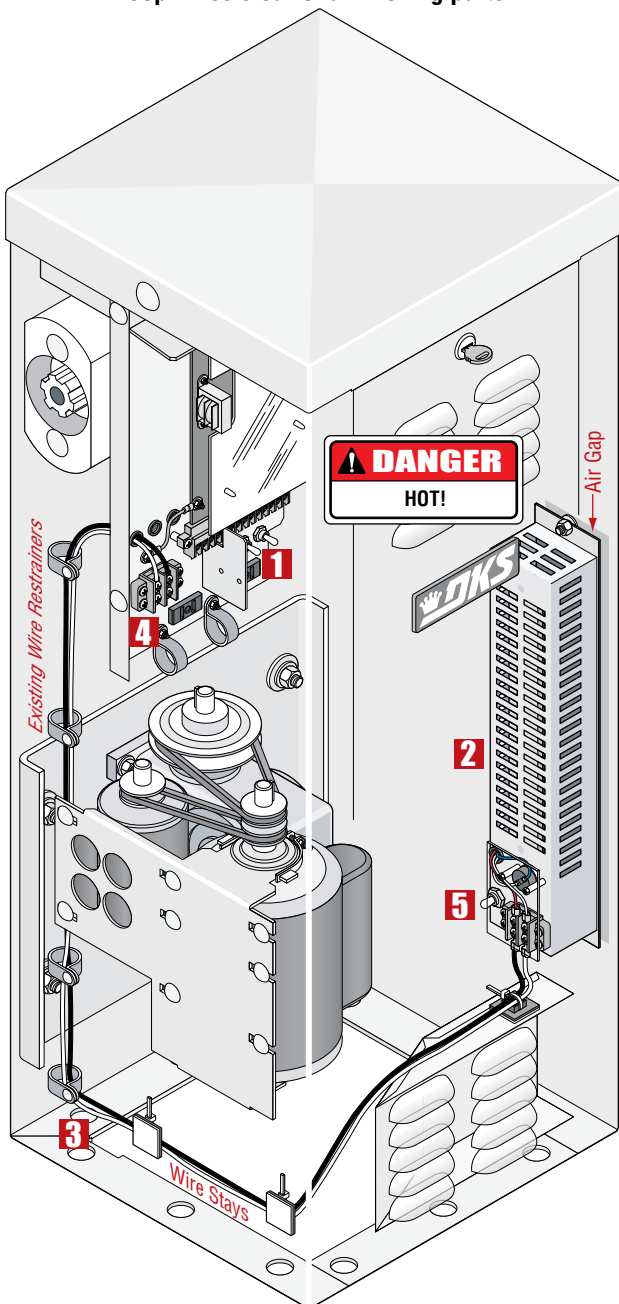

- 2** Mount heater with 2 lock nuts.
Place the 2 supplied washers between the operator wall and the heater to create an air gap.

CAUTION: Heat will be transferred to the outside wall of the operator if **NO** air gap exists between the heater and the inside wall of the operator.

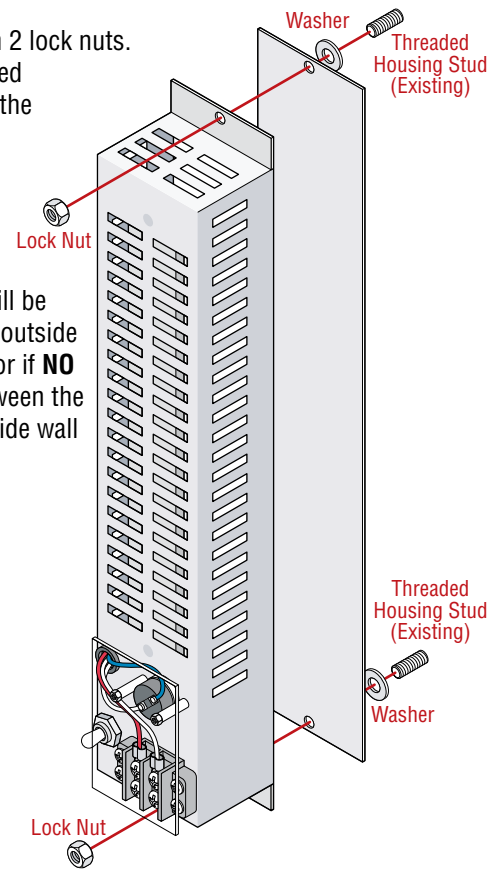

- 4** Connect the heater wires.

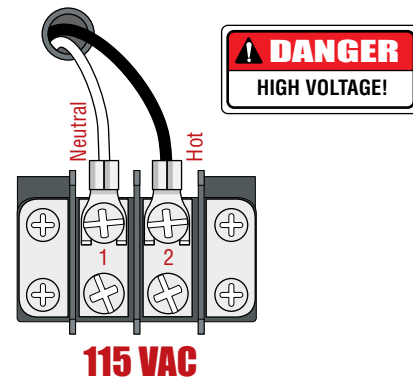

- 5** Heater switch settings.



AUTO - Normal setting. Automatically turns the heater **ON** when the temperature drops below 40°F inside the housing, and turns the heater **OFF** when the temperature rises above 40°F inside the housing.

OFF - Turns the heater off.

ON - Turns the heater on continuously. The heater will become **VERY HOT** when running continuously.

SECTION 8 - MAINTENANCE AND TROUBLESHOOTING

Inspection and service of this gate operator by a qualified technician should be performed anytime a malfunction is observed or suspected. High cycle usage may require more frequent service checks.

8.1 Maintenance

When servicing the gate operator, always check any external reversing devices (loops, photo eyes, etc.) for proper operation. If external reversing devices cannot be made operable, do not place this operator in service until the malfunction can be identified and corrected.

Always check the inherent reversing system when performing any maintenance. If the inherent reversing system cannot be made operable, remove this operator from service until the cause of the malfunction is identified and corrected. Keeping this operator in service when the inherent reversing system is malfunctioning creates a hazard for persons which can result in serious injury or death should they become entrapped.



If replacing arm, make sure warning decal is on both sides of arm.

When servicing this gate operator, always turn power **OFF!!** If equipped with batteries, make sure battery power switch is **OFF**.

If gearbox requires oil, use only Mobil SHC-629 Synthetic Gear Oil. Do not completely fill gearbox with oil. Gearbox is full when oil completely covers inspection window.

Operator Component	Maintenance	Monthly Interval		
		3	6	12
Arm(s)	Check for alignment, tightness and wear. Make sure warning decals are on operator and arm and easily visible.		✓	✓
Drive Belt(s)	Check for alignment, tightness and wear.		✓	✓
ERD Reversing System	Check that the arm reverses on contact with an object in closing cycle. Adjust the reversing sensor if necessary.	✓		✓
Batteries (On select models)	If operator is equipped with optional convenience open system, check the batteries for any leakage or loose connections. Batteries should be replaced every two years.	✓		
Convenience Open System (Not on all models)	If operator is equipped with optional DC open system, check to be sure the system opens the arm upon loss of AC power. Operator should resume normal operation when AC power has been restored.	✓	✓	✓
Fire Dept.	Check emergency vehicle access device for proper operation.	✓		✓
Gearbox	Check oil level and fill if necessary. Do not overfill.			✓
Linkages	Check internal linkages for wear. Inspect bushing for wear.		✓	✓
Loop(s)	Check all external ground loops for proper operation.	✓		✓
Pulleys	Check set screw for tightness.		✓	✓
External Reverse Device(s)	Check electric reversing edges and photo-cells for proper operation.	✓		✓
Complete System	Perform a complete system check. Include all reversing devices, loops, access system devices, Fire Dept. access devices, etc.			✓

8.2 Diagnostics Check

Have the following diagnostic tools available: VOM meter with minimum voltage memory or min-max range to check voltage and continuity. Meg-ohm meter capable of checking up to 500 megohms of resistance to properly check ground loop integrity.

A malfunction can be isolated to one of the following:

- Gate Operator
- Loop System
- Keying Devices

Disconnect all external inputs to the circuit board terminal.

1. Use caution when checking high voltage areas: terminals 1 through 6, the motor capacitor and the motor.
2. Check the input indicator LED's. They should only come ON when a keying device (card reader, push button, etc.) is activated. If any of the input LED's are ON continuously, this will cause the gate operator to hold the arm up. Disconnect the keying devices one at a time until the LED goes OFF (see troubleshooting guide).
3. If the operator stops or holds open, check external entrapment protection devices for any shorts or malfunction.
4. A malfunction in a loop or loop detector can cause the gate operator to hold the arm up, or not detect a vehicle when it is present over the loop. Pull the loop detector circuit boards from the loop ports on the operator circuit board. If the malfunction persists, the problem is not with the loop system. For more information refer to the loop detector instruction sheet and the DoorKing Loop and Loop Detector Information Manual.
5. Check that there are no shorted or open control wires from the keying devices to the gate operator. If a keying device fails to open the arm, momentarily jumper across terminals 6 and 14 on the control board terminal. If the gate operator starts, this indicates that a problem exist with the keying device and not with the gate operator.
6. Check the supply voltage and batteries. A voltage drop on the supply line (usually caused by using wires that are too small) will cause the operator to malfunction. Batteries should be fully charged for proper operation, replace batteries every two years on average.

8.3 Troubleshooting

Symptom	Possible Solution(s)
Operator will not run. Power LED is OFF.	<ul style="list-style-type: none">• Check that power to the operator is turned ON.• Check for 117 VAC with a voltmeter at control board terminals 1 and 2. If voltage measures 0, check power supply to operator or check terminal strip. If voltage measures OK, replace control board.

8.3 Troubleshooting Continued

Symptom	Possible Solution(s)
Operator will not run. Power LED is ON.	<ul style="list-style-type: none"> • Momentarily jumper terminal 6 to terminal 14. If input LED does not come ON, check terminal strip or replace control board. If LED does come on, go to the next step. <p>Remove circuit board from the terminal strip and shutoff power to the operator:</p> <ol style="list-style-type: none"> 1 Momentarily jumper terminal 2 to terminal 3 (Caution – High Voltage). Momentarily turn power ON. The motor should run. Make sure power is OFF. Remove the jumper. 2 Momentarily jumper terminal 2 to terminal 4 (Caution – High Voltage). Momentarily turn power ON. The motor should run. Make sure power is OFF. Remove the jumper. <ul style="list-style-type: none"> • If motor does not run in either or both steps above, bad motor, motor capacitor or wiring to motor.
Arm rotates up, but will not rotate down.	<ul style="list-style-type: none"> • Check LEDs on terminals 6, 7 and 9. Any of these ON will hold the arm in the UP position. This indicates a shorted input. • Check the LEDs on the loop detectors. Any ON will hold the arm in the UP position. Possible loop or loop detector problem. • If auto timer is not used (SW 1, switch 7 off), check to be sure SW 1, switch 6 is in the ON position. This will cause terminal 6 to rotate the arm down when it is activated. • Check to be sure SW 1, switch 4 is ON. This will cause terminal 8 activation, then deactivation to rotate arm down.
Down input / down loop will not rotate arm to down position.	<ul style="list-style-type: none"> • Check to be sure, switch 4 is in the ON position. • Down input must be activated, and then deactivated to cause arm to rotate down.
Loop detector LED is on continuously.	<ul style="list-style-type: none"> • Activate the reset switch on the loop detector. • Decrease loop detector sensitivity. • Check loop wire for resistance to ground with meg-ohm meter. Should be 100 meg-ohms or higher. If less than 50 meg-ohms, replace loop wire. • Be sure loop lead-in wire is twisted at least 6 turns per foot. • Be sure all loop connections are soldered. • Replace loop detector.
Loop detector LED never activates.	<ul style="list-style-type: none"> • Increase loop detector sensitivity. • Check continuity of loop wire. Should be 0 ohms. If continuity check indicates anything other than 0 ohms, check all connections. Replace loop wire. • Move loop detector board to the other loop detector port on the control board, and then check loop operation. If loop detector still fails, replace loop board. • If loop detector operates OK in the other loop port, replace control board.
Battery back-up system will not raise arm upon power outage.	<ul style="list-style-type: none"> • Check that the back-up system toggle switch is in the ON position. • Check to be sure that the 1473-010 battery back-up control board switch settings are set as described in SECTION 6. • Check the batteries for proper voltage, replace if necessary. • Replace the 1473-010 back-up control board.
Operator has intermittent functionality problems that vary.	<ul style="list-style-type: none"> • The main terminal #5 250 mA power has been exceeded. Check total amp draw of connected device(s).

8.4 Accessories Parts List

The following accessories are available for 1601 and 1602 barrier gate operators.

Plug-In Loop Detector - Plug directly into ports on circuit board simplifying wiring.

P/N 9410-010 - Single channel detector.

P/N 9409-010 - Two channel detector.

P/N 9411-010 - Single channel detector with aux relay. Controls arm lowering for vehicles but NOT for pedestrians.

P/N 9416-010 - Single channel low power draw detector

P/N 9415-010 - Dual channel low power draw detector

Loop Wire - XLPE insulation is available in 500 and 1000 foot rolls, available in Black, Blue and Red insulation.

Loop Sealant - P/N 2600-771 Asphalt P/N 2600-772 Concrete

Manual Release Kit for the 1601 or 1602 - Installs on operators **WITHOUT** the convenience open. P/N 1601-270

Meg Ohm Meter - Checks the integrity of ground loops. P/N 9401-045

Interconnection Cable - Interconnection cable contains all the necessary wires to interconnect primary / secondary operators.

Cable length: 30 ft. - P/N 2600-755 40 ft. - P/N 2600-756 50 ft. - P/N 2600-757

High Voltage Kit - Alter the input AC voltage on a 115 VAC 1601/1602 to 208, 230, 460 or 575 VAC. P/N 2600-266

Reverse Edge - Installs on the bottom of the arm. P/N 8080-016 - 6 ft. Available from DoorKing to fit all arm lengths.

Photo Cell - Prevents arm from lowering on vehicles or pedestrians. P/N 8080-018

Manual Gate Control Toggle - Allows user to manually operate gate arm. Fits inside single-gang electrical box. P/N 1200-017

Time Clock - 7 day clock, used to automatically open gate at pre-set time, fits inside operator. P/N 2600-791 7 day clock

Surge Devices - Helps prevent circuit board failure caused by lightning strikes and power surges.

P/N 1879-080 - High Voltage P/N 1878-010 - Low Voltage

Replacement Battery - Convenience open system. P/N 1801-009 (2 required)

Speed Bump - Prefabricated 6-foot speed bump reduces traffic speed through gate system. P/N 1610-150

Heater Kit - Thermostatically controlled heater for cold weather areas. 115 VAC - P/N 1601-092

Fan Kit - Thermostatically controlled fan for hot humid environments. P/N 1601-093

Gate Tracker™ - Optional control board allows the barrier gate operator to report activity to a companion 1830 series access control systems.

Wood Arm Only - 14-foot replacement wood arm. P/N 1601-348

Wood Arm Mounting Kit (No Arm) - Wood arm mounting bracket, hub and mounting hardware. P/N 1601-240

Wood Folding Arm Kit (with Arm) - Low headroom applications (Arm included). P/N 1601-384

Plastic Arm Only - 12-foot replacement plastic arm. P/N 1601-571

Plastic Arm Mounting Kit (No Arm) - Plastic arm mounting bracket, hub and mounting hardware. P/N 1601-241

Plastic Folding Arm Kit (with Arm) - Low headroom applications (Arm included). P/N 1601-383

Standard Aluminum Arm Only - 14-foot replacement aluminum arm. P/N 1601-516

Aluminum Arm Mounting Kit (No Arm) - Aluminum arm mounting bracket, hub and mounting hardware. P/N 1601-242

Aluminum Folding Arm Kit (with Arm) - Low headroom applications (Arm included). P/N 1601-610

Aluminum Break-Away Arm Only - 14-foot replacement aluminum break-away arm. P/N 1601-522

Aluminum Break-Away Arm Mounting Kit (No Arm) - Aluminum arm break-away mounting bracket, hub and mounting hardware. P/N 1601-285

Aluminum Lighted Arm Only - 14-foot replacement aluminum lighted arm. P/N 1601-518

Aluminum Lighted Arm Mounting Kit (No Arm) - Aluminum arm lighted mounting bracket, hub and mounting hardware. P/N 1601-531

Aluminum Lighted Break-Away Arm Only - 14-foot replacement aluminum lighted break-away arm. P/N 1601-520

Aluminum Lighted Break-Away Arm Mounting Kit (No Arm) - Aluminum arm lighted break-away mounting bracket, hub and mounting hardware.

P/N 1601-285

20 Ft 3-Piece Aluminum Arm Kit - For the 1602 barrier gate operator ONLY. P/N 1602-162

24 Ft 3-Piece Aluminum Arm Kit - For the 1602 barrier gate operator ONLY. P/N 1602-164

27 Ft 3-Piece Aluminum Arm Kit - For the 1602 barrier gate operator ONLY. P/N 1602-166

20 Ft 3-Piece Lighted Aluminum Arm Kit - For the 1602 barrier gate operator ONLY. P/N 1602-172

24 Ft 3-Piece Lighted Aluminum Arm Kit - For the 1602 barrier gate operator ONLY. P/N 1602-174

27 Ft 3-Piece Lighted Aluminum Arm Kit - For the 1602 barrier gate operator ONLY. P/N 1602-176

(Aluminum arm mounting brackets, hubs and mounting hardware included in all 3-piece aluminum arm kits)

20 Ft 3-Piece Wood Arms Only - For the 1602 barrier gate operator ONLY. P/N 1602-340

20 Ft 3-Piece Wood Arms Mounting Kit - Wood arm mounting brackets, hubs & mounting hardware for 20 ft 3-piece wood arms. P/N 1602-041

1/2 or 1 HP 115 VAC

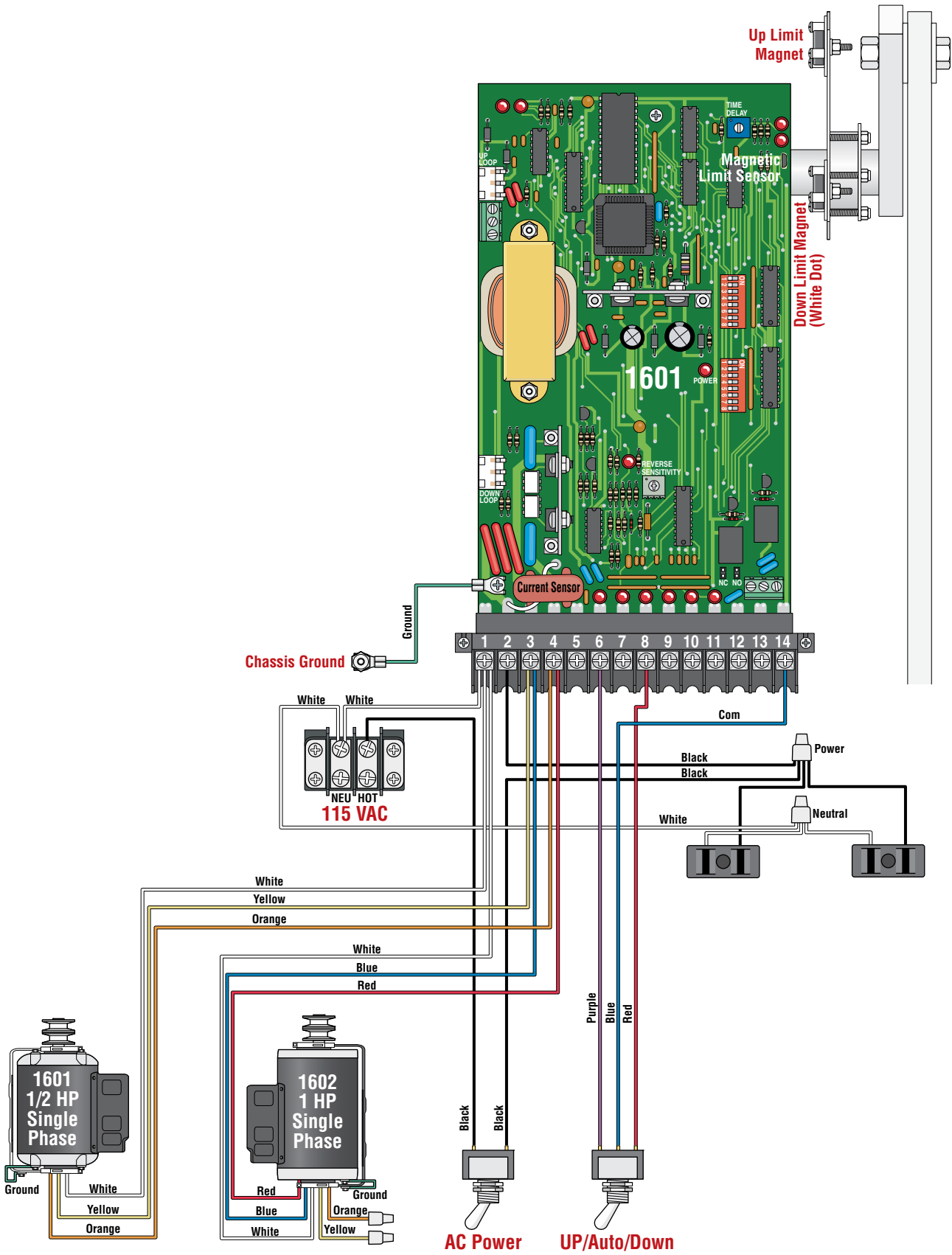

1/2 or 1 HP 115 VAC / Convenience Open

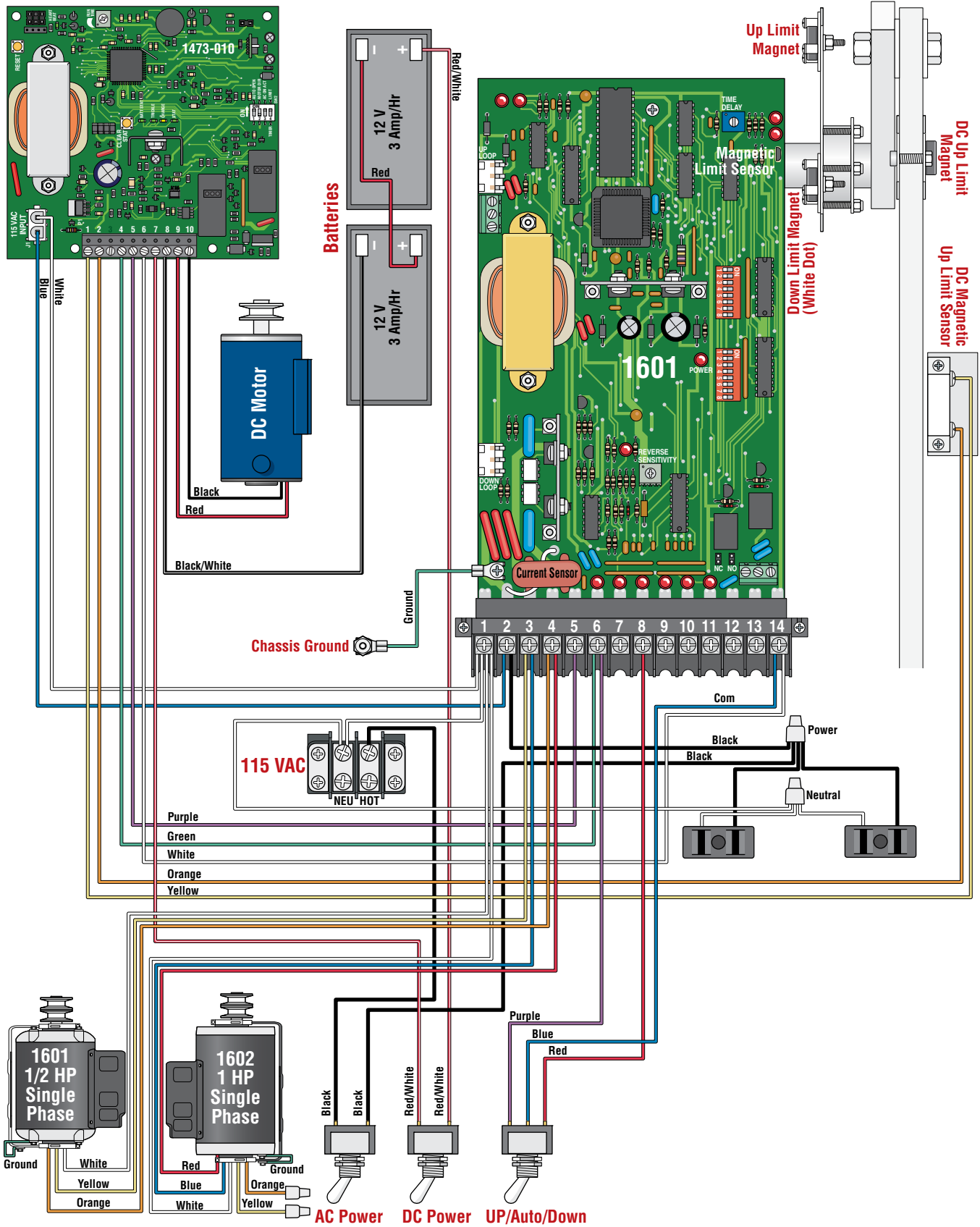

Installation/Owner's Manual

1601 / 1602

Barrier Gate Operator

Use this manual for circuit board 1601-010 Revision W or higher.

1601-065-D-12-17

THIS PRODUCT IS TO BE INSTALLED AND SERVICED BY A TRAINED GATE SYSTEMS TECHNICIAN ONLY.
Visit www.dkslocator.com to find a professional installing and servicing dealer in your area.



www.doorking.com

DoorKing, Inc.
120 S. Glasgow Avenue
Inglewood, California 90301
U.S.A.

Phone: 310-645-0023
Fax: 310-641-1586