

**TOYOTA**

**OPERATOR'S MANUAL**

**4SDK3,4**

# FOREWORD

This manual explains the proper operation and maintenance of Toyota industrial vehicles as well as daily lubrication and periodic inspection procedures. Please read this manual thoroughly even though you may already be familiar with other Toyota industrial vehicles because it contains information which is exclusive to this series of vehicles. The manual has been produced based on a standard vehicle. However, if you have questions on other types, please contact your Toyota industrial vehicle dealer. Toyota reserves the right to make any changes or modifications to this manual without giving previous notice and without incurring any obligation.

# BEFORE INITIAL OPERATION

● **Please read this manual thoroughly.** This will give you a complete understanding of Toyota industrial vehicles and permit you to operate them correctly and safely. Proper handling of new vehicles promotes performance and extends service life. Drive with special caution while becoming familiar with a new vehicle. In addition to the standard operating procedures, pay attention to the following safety items.

● **Always perform pre-operation check and periodic maintenance.** This will prevent sudden malfunctions, improve work efficiency, save money and insure safe working conditions.

● **Use only the recommended types of fuel and lubricants.** Low-grade fuel and lubricants will shorten service life.

● **Warm up the engine before operation.**

● **Avoid reckless operation while working.**

● **If you hear any unusual noise or sense anything unusual, inspect and repair immediately.**

● **When towing a vehicle, move it as slowly as possible and only within a short distance.** Before towing a vehicle, loosen two HST pump bypass valves by a few turns. Towing must be limited to a short distance and at about a walking speed. Towing over a long distance at a high speed may damage the HST motor.

● **Never use spray starting fluid.**

Either on diesel engine as damage to pistons and pre-combustion chambers may result.

● **Be sure to avoid overloading and one-sided loading.** Overloading and one-sided loading are very dangerous.

● **Get to know your Toyota industrial vehicle thoroughly.** Read the operator's manual thoroughly prior to operating the vehicle. Get to know its operation and components. Learn about the safety devices and accessory equipment and their limits and precautions. Be sure to read the caution plate attached to the vehicle.

● **Learn safe driving points and safety management.** Understand and maintain working area traffic rules. Ask the work area supervisor about any special working precautions.

● **Wear proper clothing for easy operation.** Improper clothing will interfere with vehicle operation and cause an accident.

● **Avoid electric power lines.** Know the locations of inside and outside power lines and maintain sufficient distance.

# CONTENTS

Before Initial Operation .....	1
Main Components .....	2
Driving Controls and Instrument Panel .....	2
Instruments .....	3
Switches and Controls .....	4
Operator's Seat and Frame .....	7
Safety Tips .....	10
Correct Operation .....	12
Materials Handling Operations .....	14
Handling Vehicle in Cold Season .....	16
Handling Vehicle in Hot Season .....	17
Long Term Storage .....	17
Transportation .....	18
Self Service .....	18
Pre-operation Check .....	21
Before Storing the Vehicle .....	25
Weekly Maintenance .....	25
Periodic Maintenance .....	27
Periodic Replacement Table .....	28
Periodic Maintenance Table .....	29
Service Data .....	32
Lubrication Chart .....	34
Frame Serial Number .....	35
Vehicle Dimensions .....	35
Recommended Lubricants .....	35
Attached Table .....	36

## MAIN COMPONENTS

1. Bucket
2. Operator guard
3. Dump cylinder
4. Lift cylinder
5. Fuel tank
6. Front wheel
7. Engine hood
8. Rear grill
9. Rear wheel
10. Reduction device service hole cover

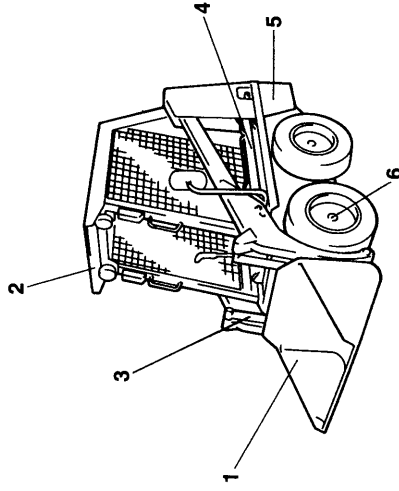

## DRIVING CONTROLS AND INSTRUMENT PANEL

1. Working pilot lamp (Option)
2. Working lamp switch (Option)
3. Light control switch
4. Hour meter
5. Water temperature gauge
6. HST oil filter warning lamp
7. HST oil temperature warning lamp
8. Glow indicator lamp
9. Fuel gauge
10. Charge warning lamp
11. Engine oil pressure warning lamp
12. Ignition switch
13. Lift pedal
14. Attachment pedal (Option)
15. Dump pedal
16. Parking brake lever
17. Parking brake release lever
18. Horn switch
19. Turn signal switch
20. Steering control levers
21. Driver's seat adjusting lever
22. Seat belt
23. Accelerator lever
24. Driver's seat
25. Seat bar

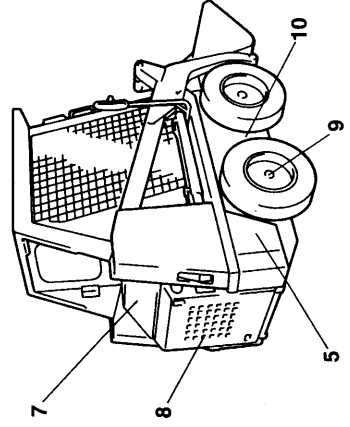
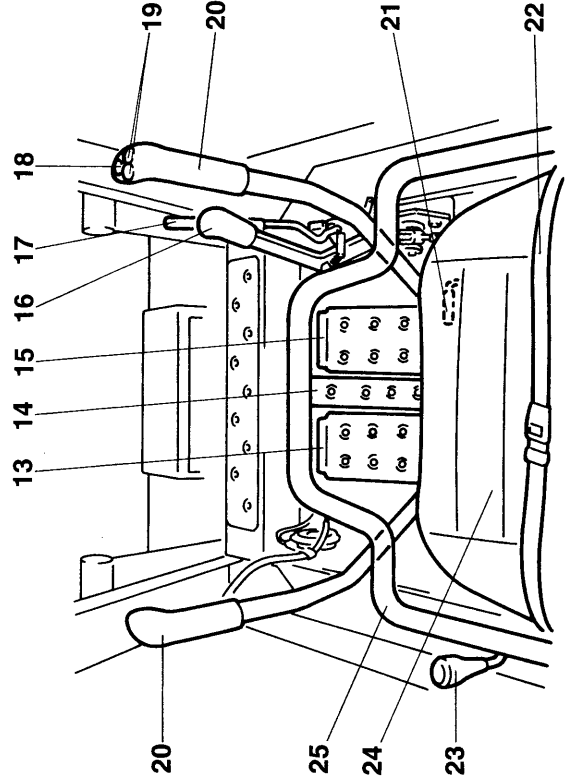
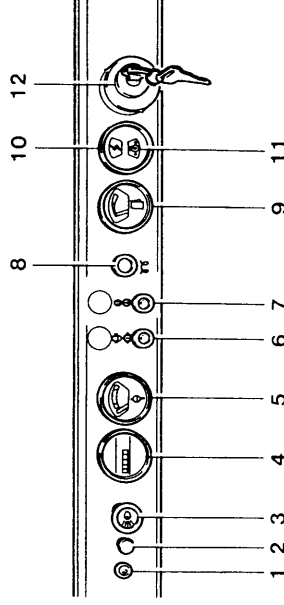

# INSTRUMENTS

## Charge warning lamp

Lights to indicate trouble in the charging system.

The lamp comes on when the ignition switch is turned on and should go off when the engine starts.

If the lamp remains on, immediately stop the vehicle, ensure that the fan belt is not loose or broken, and restart the vehicle. If the lamp still remains on, it indicates malfunction in the charging system and should be immediately inspected or repaired.

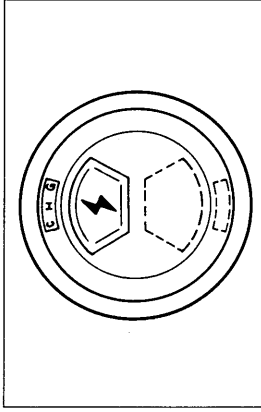

## Hour meter

Only operates when the ignition switch is on. It indicates the total number of vehicle operating hours so that you will know when it is time to perform periodic inspection on the vehicle.

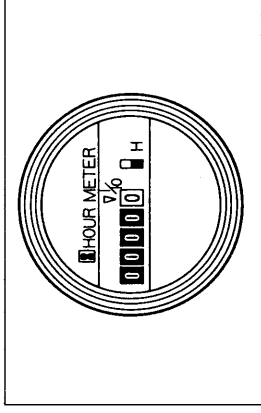

## Engine oil pressure warning lamp

Lights to indicate low engine oil pressure.

The lamp comes on when the ignition switch is turned on and should go off when the engine starts.

If the lamp comes on during operation, this indicates a malfunction in the lubrication system or an oil shortage. Stop operation immediately and have the vehicle inspected or repaired.

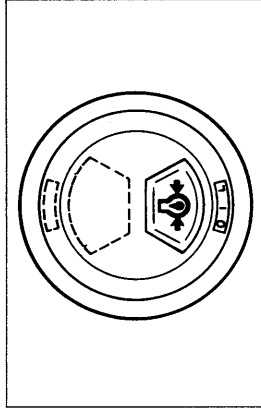

## Water temperature gauge

Indicates the temperature of the engine cooling water. When needle is in the red zone, indicating that an overheat condition exists, stop operation immediately. Allow the engine to continue running in an idle condition and wait for the temperature to drop.

Even for a temporary overheat, be sure to inspect for water leakage. Warning: Do not open coolant cap until temperature gauge indicates cool. Check for sufficient cooling water, loose fan belt, or unusual condition in the cooling system.

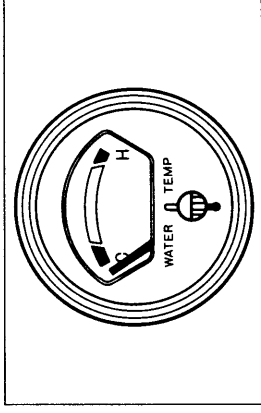

## Fuel gauge

Shows the amount of fuel in the fuel tank.

It operates when the ignition switch is on. "F" indicates full and "E" indicates empty.

If the surface is not level, the correct amount will not be indicated.

To avoid getting air into the fuel system, refuel before the indicator reaches "E".

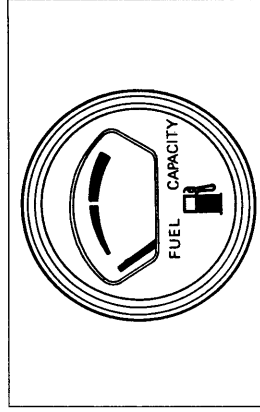

## Working pilot lamp (option)

The working pilot lamp comes on to indicate that the rear working lamp is on. It comes on when the working lamp switch is pulled out.

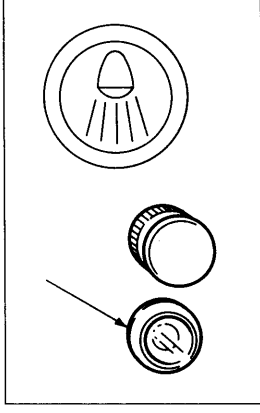

# SWITCHES AND CONTROLS

## HST oil temperature warning lamp

The red lamp comes on when the temperature of the hydraulic fluid to drive HST (hydrostatic transmission) climbs to the specific temperature.

The lamp comes on when the ignition switch is turned on and will go off when the engine is started.

When the lamp comes on during operation, immediately stop operation and let the engine run at half throttle until the lamp goes out.

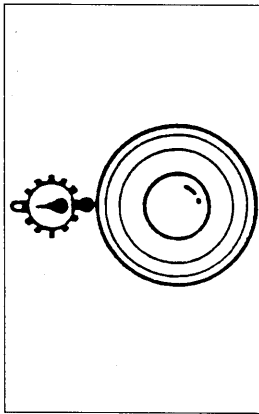

## HST oil filter warning lamp

If the HST oil filter becomes clogged, a red lamp lights to warn the operator. This lamp also lights when the ignition switch is turned to the ON position, but goes off again when the engine starts. When the lamp comes on, immediately stop operation, and replace the HST oil filter. Never continue to operate the vehicle after the lamp has come on, or an HST breakdown may occur.

There is nothing unusual if the lamp comes on when the engine runs slowly but goes out with the engine speed increased.

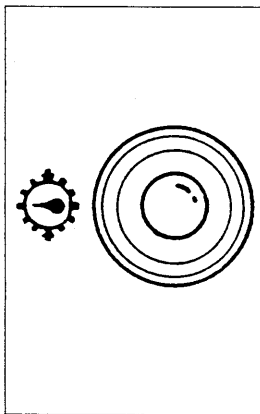

## Glow indicator lamp

Indicates heating of glow plugs. When the ignition switch is turned to GLOW, the lamp comes on and glow plug heating begins. This lamp goes off after about 15 seconds — this indicates that the engine is ready to be started, so please start the engine at this time.

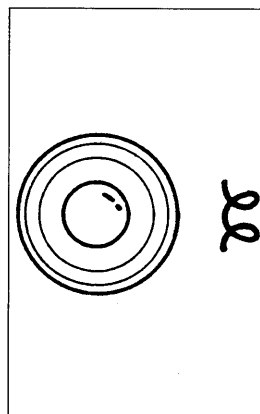

## Ignition switch

The ignition key is inserted with the teeth facing upward.

**OFF** ... The ignition switch is turned off. Key insertion and withdrawal is performed in this position.

**ON** ... Engine operation position. Located one position clockwise from the OFF position.

**START** ... Engine start position.

Located one position clockwise from the ON position. After engine start, release the key and it will return to the ON position automatically.

**GLOW** ... Activates glow plugs to warm up the engine combustion chamber when the engine is cold. Located one position counterclockwise from the OFF position. The engine can easily be started when the glow indicator lamp goes off.

## Caution

- Do not leave the switch in the ON position when the engine is stopped. Leave the switch in the ON position during engine operation.
- Do not turn the switch to the START position while the engine is running. This may damage the starter the motor.
- Do not hold the switch in the START position for more than 30 seconds. Return the switch to the OFF position and wait at least 20 seconds prior to attempting restart.

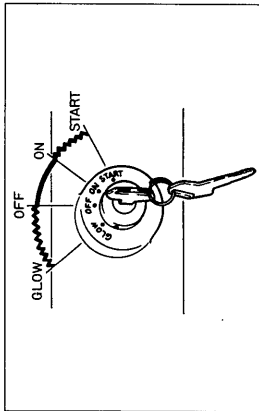

### Light control switch

This is a three-position pull-out switch. The lamps marked with ○ in the table below come on at each position.

	1st position	2nd position	3rd position
Head lamp		○	
Side clearance lamp, parking lamp, tail lamp (option)	○	○	○

### Caution

**Do not keep the head lamp and other lamps on for a long time when the engine is not running.**

**It may consume the battery charge, resulting in failure in engine starting.**

### Working lamp switch (Option)

Use this switch to turn the working lamp on and off.

**On...** Pull the switch out.

**Off...** Push the switch in.

### Caution

**Do not keep the working lamp and other lamps on for a long time when the engine is not running.**

**It may consume the battery charge, resulting in failure in engine starting.**

### Accelerator lever

The desired engine speed can be obtained by pushing this lever forward or pulling it back.

**IDLING:** Pull the lever all the way towards you.

**MAXIMUM SPEED:** Push the lever all the way forward.

### Note

Start the engine with the accelerator lever placed slightly forward from the idling position. When carrying out loading operation, first raise the engine speed by pushing the lever forward, then keep the engine at a constant speed.

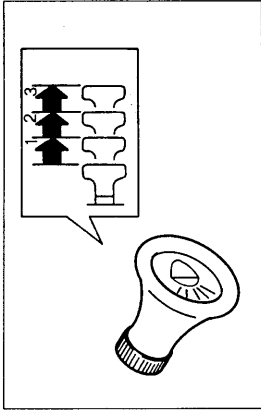

### Horn switch

The horn is sounded by pushing the switch at the tip of steering control lever (at right side). The horn can be sounded even with the ignition switch OFF.

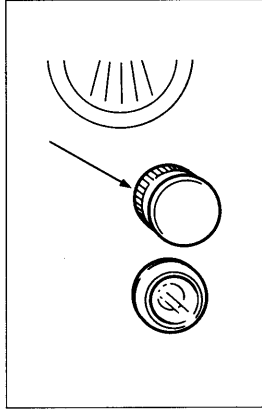
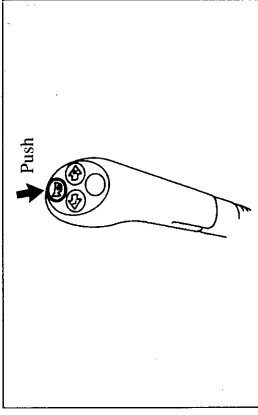

### Turn signal switch

(Turn signal lights are OPTIONAL, but this turn signal switch is equipped as standard.)

The turn signals blink to indicate the direction to which the vehicle is to turn.

**LEFT TURN ...** Push the switch to left (L).

**RIGHT TURN ...** Push the switch to right (R). This switch functions even with the ignition switch OFF.

The turn signal blinks while the switch is pressed.

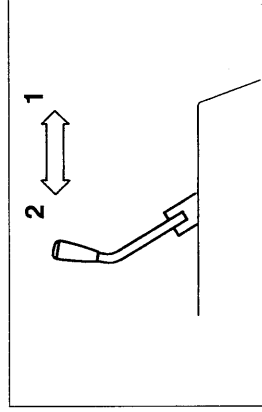
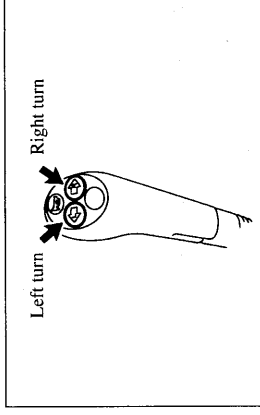

1. Maximum speed
2. Idling speed

### Steering control levers

These are the levers for steering operation (setting the wheel rotational direction) and speed control.

**FORWARD ...** Operate the lever forward.

**BACKWARD ...** Operate the lever backward.

To turn the vehicle, pull backward the lever at the side to which the vehicle is to be turned, and push forward the lever at the other side. The speed is adjusted by the degree of lever operation. Refer to the section on "Operation" for detail.

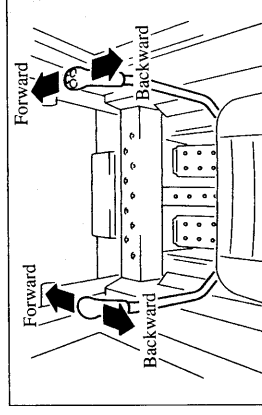

### Lift pedal

This pedal controls the hydraulic lifting system of the bucket for loading.

**UP** ..... Depress the rear side of the pedal.  
**DOWN** ..... Depress the front side of the pedal.  
 The speed is adjusted both for lifting up and lowering by the engine speed (accelerator lever operation) and the degree of the pedal depressing. Press the front part of the pedal fully to the floor from the descending stage. Then the pedal will come to be fixed shifting into the floating stage, moving the lift arm into a floating status. To release the lift arm from the floating status, press the rear part of the pedal fully to the floor.

Since pressure leveling controls the oil returning to the lift cylinder through the valve, if the level of the returning oil is insufficient, the valve may not operate.

For this reason, leveling may not occur if the pressure on the lift pedal is light, or the engine speed is low.

#### Caution

- Always bring the lift arm to its lowest position before shifting into or out of the floating stage.
- When leaving the driver's seat, always make sure that the pedal is in neutral position.

#### Note

Each material handling pedal is designed so that it can not be operated unless the operator sits on the operator's seat, BUCKLES the seat belt, lowers the seat bar to its lowest position, and turns the ignition switch to the ON position.

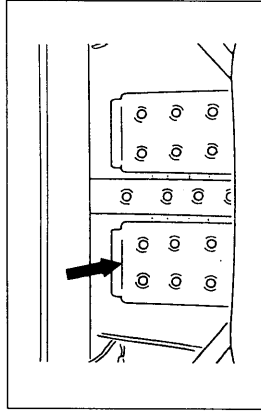

### Dump pedal

This is the pedal to tilt the bucket forward or backward.

**FORWARD TILT** ... Depress the front side of the pedal.

**BACKWARD TILT** ... Depress the rear side of the pedal.

The speed is adjusted both for forward and backward tilt by the engine speed (the accelerator lever operation) and the degree of the pedal depressing.

### Attachment pedal (Option)

This pedal is used when the attachment is mounted.

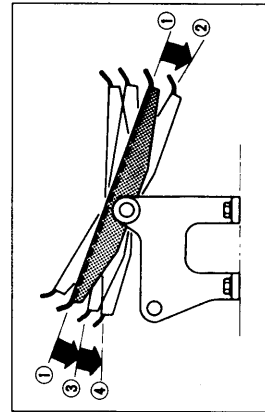
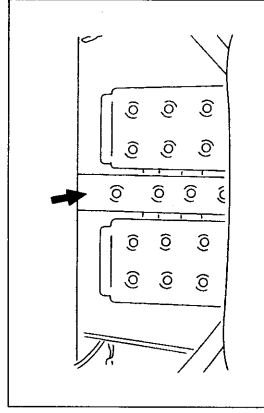

- 1 Neutral
- 2 Upward
- 3 Downward
- 4 Float

### Pedal lock

To prevent danger resulting from an erroneous operation of the material handling pedal, the pedal is equipped with an automatic locking device.

The pedal lock will be automatically released only when the driver sits down on the driver's seat, lowers the seat bar to its lowest position, and switches on the ignition switch with the seat belt applied to him.

#### Caution

Failure to observe the correct operating instructions for the lock device will result in an accident or possible damage to the equipment.

Especially when leaving the driver's seat, be absolutely careful for the following points:

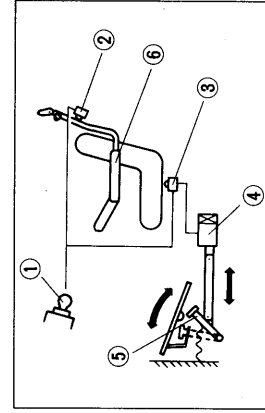

- 1 Ignition switch
- 2 Seat bar switch
- 3 Seat switch
- 4 Solenoid
- 5 Stopper
- 6 Seat bar

# OPERATOR'S SEAT AND FRAME

- Always return the lift pedal to its neutral position if it remains in the floating stage.
- Make certain there are no articles on the operator's seat.
- Release the seat bar and raise it up completely.
- Disconnect the seat belt, and hook it over the belt hook.
- Make sure the ignition switch is turned OFF.

## Material handling pedal unlock lever

Use this lever to unlock the material handling pedal.

**Pedal unlocking:** Raise the lever.

Releasing the lever causes the lever to return automatically to the locked state by the spring force.

### Caution

Use this lever only when the pedal cannot be released automatically because of the pedal lock ring freezing. Do not operate this lever when the material handling pedal is in ordinary state.

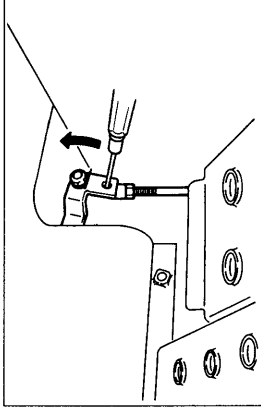

## Operator's seat

Forward and backward adjustment is possible using the adjust lever.

Adjust to a comfortable operating position. Since the pedal lock switch is installed underneath the seat, always sit on the center of the seat when operating the vehicle.

### Caution

Always make sure that there are no articles on the operator's seat when leaving the operation. Failure to observe this instruction can cause a malfunction of the pedal lock device.

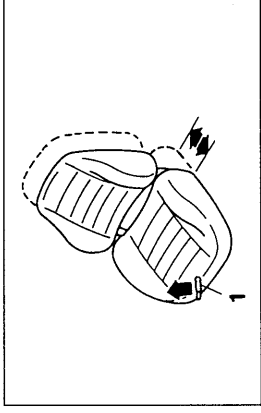

1. Adjust lever

## Seat belt

### (Application)

1. When buckling the belt, make sure that it is not twisted and insert the plate on the right side into the buckle on the left until it clicks to the position.

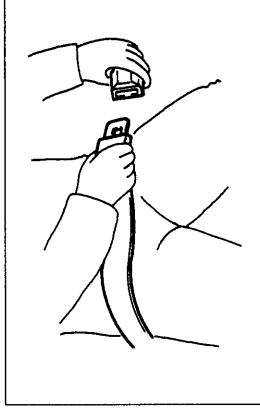

## Parking brake lever

To set the parking brake, push LEVER ① forward firmly. To release the brake, pull LEVER ② towards you while pressing forward on LEVER ①.

### Caution

Be sure to apply the parking brake and use wheel blocks when parking on an incline.

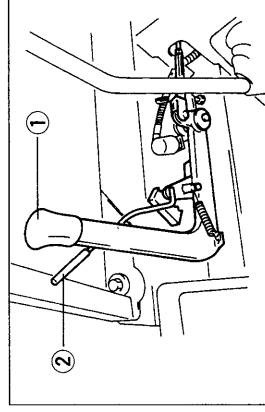

2. When the belt length is short, lengthen the belt by adjusting it as illustrated.

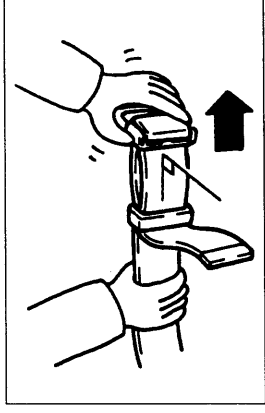



3. Be sure that the belt is always set on the hip bone.
4. Pull the belt to eliminate any slack, as illustrated.

**(Release)**

1. Press the button in the center of the buckle.
- Set the released belt to the belt hook on the right side of the operator guard.

**(Caution)**

- Always buckle the seat belt when operating the vehicle.
- Always make sure the seat belt is disconnected when leaving the operator's seat.

**Seat bar**

Hold the tip end of the seat bar while sitting on the operator's seat, and lower the seat bar until it clicks in the position. The pedal lock is not released until the seat bar is lowered to its lowest position.

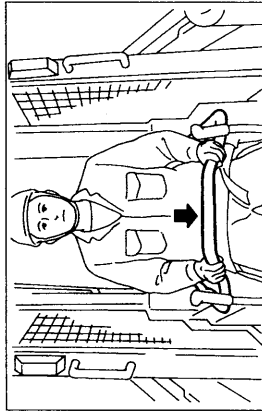
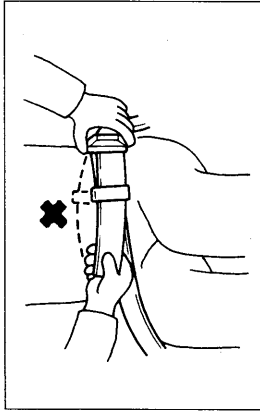

When leaving the vehicle hold the tip end of the seat bar and raise it for unlocking. Raise it fully before getting off the vehicle.

**Caution**

- Always lower the seat bar when driving the vehicle.
- Always raise the seat bar completely when not in the operators seat.

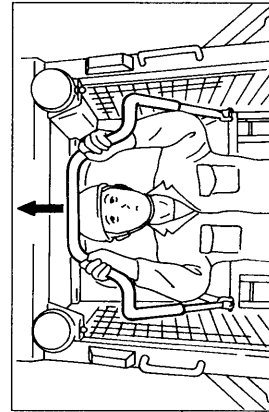

**Seat panel**

The seat panel can be opened rearward by unlocking the panel latch. When it is opened, release the panel stay on the rear side of the seat panel and set its free end to the hook on the operator guard.

When closing the seat panel, set the panel stay to the catch bracket on the rear side of the panel and close the panel gently.

**Caution**

After closing the seat panel, always lock the panel latch.

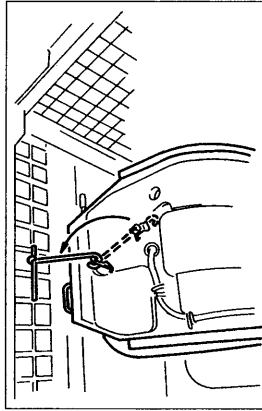
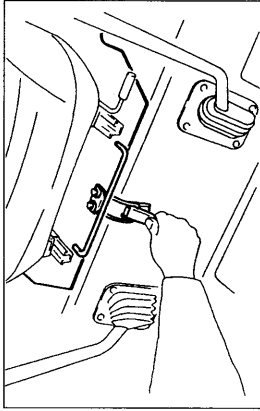

**Bucket lock lever**  
This lever is used when the bucket is replaced. **TO LOCK** . . . . . Lift the lever. **TO RELEASE** . . . . . Bring it down.

**Caution**

- Make certain the bucket lock lever is operated after the bucket has been grounded and the engine stopped.
- Make certain the lever is operated after the operator has climbed out of the vehicle.

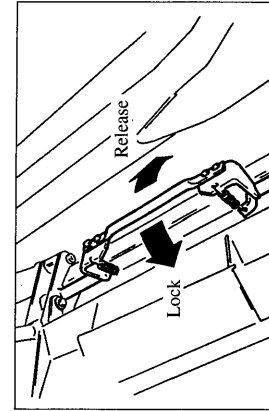

For more details, refer to the appropriate paragraphs of "the self-service . . . Replacing the bucket."

### Lift arm lock pin

The lift arm lock pin is located at the front top right-hand side of the operator guard.

#### Caution

When it is really necessary to keep the lift arm lifted up during repair work, always use the lock pin to make sure that the lift arm is not lowered.

#### (Lock pin installation method)

1. Start the engine, and bring the lift arm slightly above the lock pin position.
2. Stop the engine.
3. Loosen and raise the lock screw, and move it outward.
4. Tighten the lock screw after lowering it to fix the lock pin.
5. Slowly lower the lift arm.

### Engine hood

The engine hood opens up and forward to permit inspection and servicing.

#### Note

When opening the engine hood, lift up the hood, detach the stay of the hood from the catch, securely fit it to the holes in the frame. After closing the engine hood, always check firm locking.

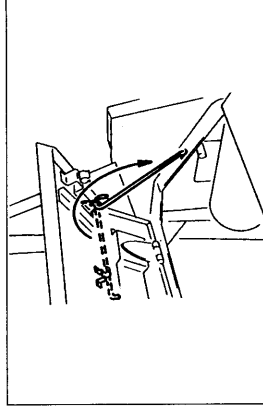
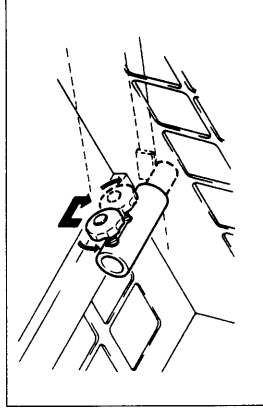

### Rear hooks

Hooks are provided on both sides on the rear side of the frame for use in towing or transportation of vehicle.

#### Caution

- Use a sufficiently strong wire rope for towing.
- Use lifting hooks (option) when lifting the vehicle.

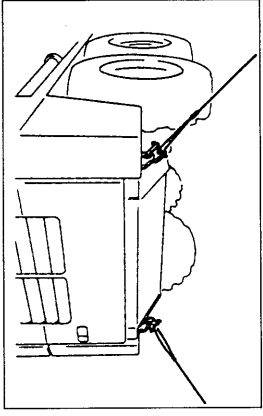

### Lifting hooks (option)

Use these hooks when lifting the vehicle.

Front and rear lifting hooks are provided. Install the front hooks to the left and right frame, and rear hooks to insides of the left and right frame pillars.

#### Caution

- Use sufficiently strong wire ropes when lifting the vehicle.
- Always use lifting hook when lifting the vehicle.

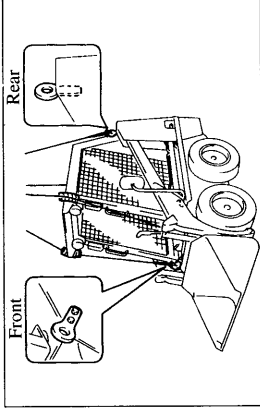

### Rear grille

The rear grille can be fully opened to the rear to facilitate everyday inspection and maintenance.

To open the rear grille, raise the door latch, and swing the grille rearward.

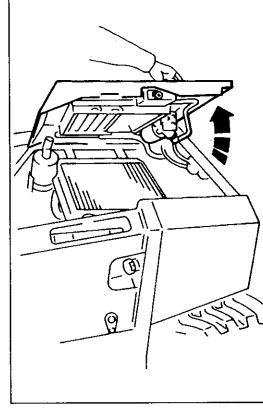

### Engine oil drain plug

The engine oil drain plug is located in the lower rear of the frame. When changing the engine oil, remove this plug to drain out the old oil.

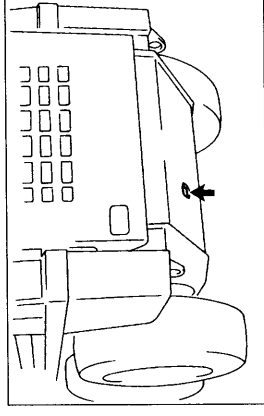

# SAFETY TIPS

## Being safety-minded

Safe operation is for the protection of yourself and others. Pay special attention to the following points for safe operation. Always observe these instructions.

All operators are recommended to be safety minded.

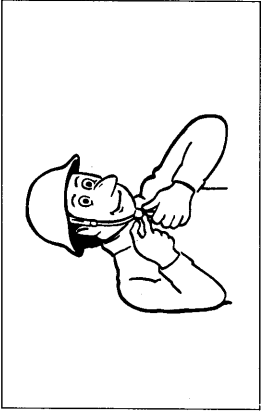

- When climbing in and out of the operator's seat, to ensure safety, first ground the bucket, and then use the assist grip and steps with the engine stopped.
- Wipe off mud or oil adhered on the operator's seat, steps and assist grip thoroughly to prevent slipping.
- Be sure to adjust the position of the operator's seat before starting and operating the vehicle.
- When starting the vehicle in an enclosed space, make sure there is enough ventilation. EXHAUST FUMES CAN KILL.
- Never attempt to oil, inspect, adjust, or repair the vehicle while it is moving.

## Checks before operation

- Be well familiarized with the vehicle operation.
- Have full knowledge of vehicle warning and safety devices.
- Carefully read indicators and nameplates attached to the vehicle and carry out correct operation. Torn or peeled indicators must be repaired immediately.
- Always carry out pre-operation check.
- Maintenance and control are the key points for safety.  
Always repair any defect and never use a vehicle that has not been checked and repaired.
- Always wear protectors such as a helmet and safety shoes. A void loose working clothes so as not to be caught or trapped by levers and other moving parts or components.
- If tools and/or parts are scattered on the floor and around the operator's seat, clear them away so as not to obstruct operation.
- Always buckle the seat belt when operating the vehicle.

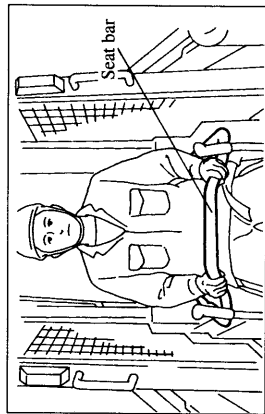
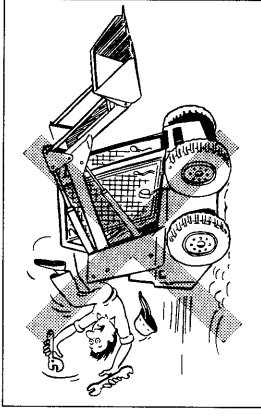
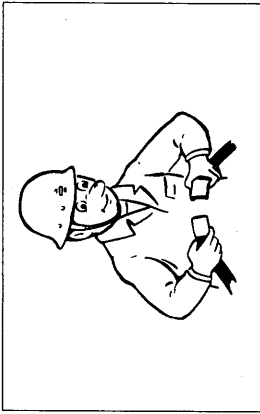

- Never operate the vehicle if you are under the influence of alcohol or medications, particularly medications which indicate they can cause drowsiness. Poor physical conditions will cause operation or judgment errors.
- Never operate the vehicle when you are tired.
- Be sure to stop the engine and eliminate any fire or spark source before checking or adding fuel, lubricant, or coolant. Always extinguish a lighted match or cigarette. Firmly tighten each oil filler cap.
- In refueling, start the fuel supply after the fueling nozzle is completely inserted in the filler port. Otherwise, spark generated by static electricity may cause a fire accident.

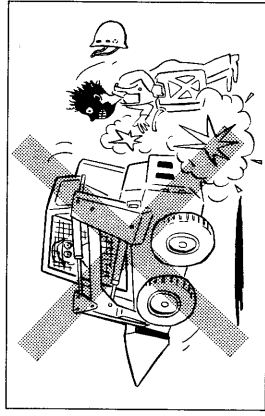

- Pay special attention and take sufficient time when practicing operation.
- Never try to start or operate the vehicle from any position other than sitting in the operator's seat.
- When starting the engine and the vehicle, sound the horn or make a signal to warn people in the area. Pay special attention to the rear side of the vehicle.

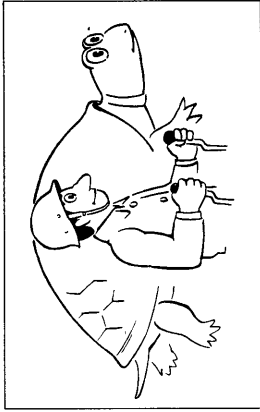

- Never try to pick up a load beyond its rated capacity. It will not only affect the vehicle adversely but also cause unexpected accidents.
- Always pay careful attention to the vehicle operation and surrounding conditions. Absent minded operation is extremely dangerous.

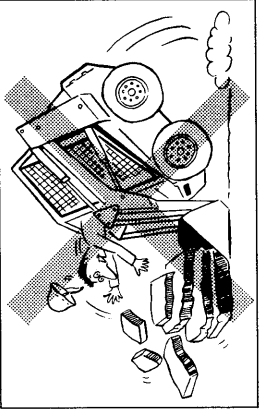

### Caution during operation

- Never attempt the following operations because they are very dangerous:
  - Sudden stops, starts and turns
- If any abnormality is found during operation, immediately stop the vehicle and engine, and have the vehicle checked or repaired.
- Do not use the vehicle for other than the specified purpose. Never carry anyone in the bucket.
- Never carry anyone other than the operator on the vehicle.
- When traveling on a rough ground, select as low a speed as possible and never attempt quick direction change.

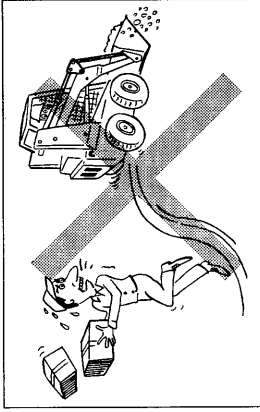

- Always keep the bucket low when transporting a load.
- Never attempt to cross a steep slope even obliquely.
- When traveling on slope with a load, travel in the forward direction for an ascent or in the backward direction for a descent.
- When the bucket of the vehicle is empty, if ascending a hilly road (slope), drive the vehicle in the reverse direction, and if descending such a road, drive the vehicle in the forward direction for ensuring stable driving.

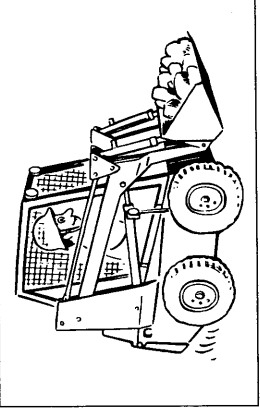

### Caution for parking and stopping

- For parking, select the specified area or a safe area outside the operation site. Select a solid, flat location as the parking place. If it is necessary to park on a slope, use wheel blocks and bring the bucket into close contact with the ground.
- When parking on a load, select a place not obstructing passage of other vehicles and passengers. If necessary, use fences, signal lights and other warning signs.

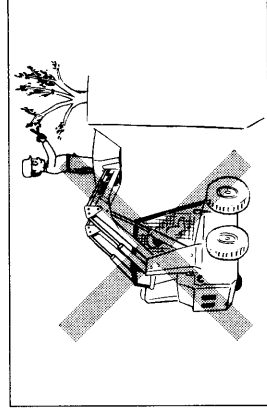

# CORRECT OPERATION

- Before leaving the vehicle, lower the bucket, stop the engine, and set the parking brake. Never leave the engine key in a parked vehicle.

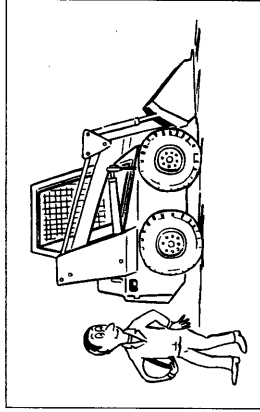

- Never travel, park, or stop on or near easily flammable materials such as dry grass, straw, and waste paper because high temperature near the exhaust pipe may start a fire. Before starting, remove any flammable materials from the area of the exhaust tube.
- When parking the vehicle in a garage, make sure there are no flammable materials such as dry grass, straw, paper, cloth, matting, lubricants, resin products, or old tires. Always keep a distance of at least 30 cm (12 inches) between the end of the exhaust pipe and lumber, veneer, or the like exhaust gas may discolor, deform, or even ignite such materials.

## Notes when climbing out of the vehicle

- Always bring the vehicle to a complete stop before climbing out of it.
- Jumping off the vehicle is dangerous and be sure not to do so. Also, always climb out of the vehicle turning your face to it.

## Other cautions

- Do not stick a finger out from the operator guard during operation.
- When checking and maintaining the vehicle, bring down the lift arm and ground the bucket. When circumstances compel to check and maintain the vehicle with its lift arm in the up position, make certain the lift arm is supported by the lift arm lock pin or it is securely locked by means of the safety block or safety support to prevent it from coming down.
- Never perform loading work with the operator guard removed from the vehicle. Failure to observe this can cause the operator to be exposed to great danger.
- Always bring down the lift arm, ground the bucket, and stop the engine before checking and cleaning the pedal lock device.
- Clean the area around the pedal lock device once a week.
- Damaging the damper holding the seat will be dangerous as high pressure gas jetting will occur. Never attempt damper cover removal.

## The vehicle must not be altered

Never alter the vehicle or the loading equipment in any way that may affect their performances, safety and strength.

- ### Handling new vehicles
- Optimum performance and service life of your TOYOTA Industrial Vehicle are obtained with proper handling of new vehicles. During the first 100 hours of operation, pay special attention to the following items:
1. Do not unnecessarily race the engine.
  2. Sufficiently warm up the engine after and before travel.
  3. Avoid rough operation and unreasonable operation.

4. Always review new vehicle service and periodic inspection mentioned in the "Service Booklet".
5. Lubricate, grease, and replace oil as recommended.

## Engine starting and after starting

Sit down in the driver's seat, buckle the seat belt, and lower the seat bar to its lowest position. Place the steering control levers and lift and dump pedals into NEUTRAL position and apply the parking brake. Pay special attention to safety in the surroundings and ventilation in a room or closed area.

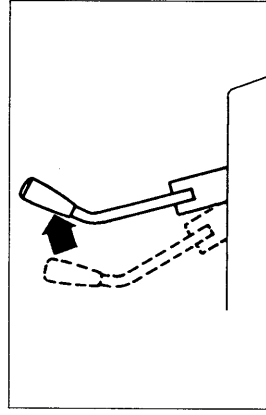

1. Set the accelerator lever slightly forward from the idling position.
2. With the ignition switch in the GLOW position, make sure that the glow indicator lamp goes on and then (about 15 seconds) off again.
3. With the ignition switch ON, make sure that each warning lamp goes on.
4. Set the ignition switch into "START" position and activate the starter motor (continuous less than 30 seconds) to start the engine.
5. As soon as the engine starts, take hands off the key. It automatically returns to the ON position.
6. After the engine starts, return the accelerator lever to idle position. Make sure that each warning lamp goes off and that each instrument is operation normally and warm the engine up at idle.

## Caution

The HST pump requires at least 5 minutes to warm up. For cold starting, see "Starting in Cold Weather."

### Engine warming

Cultivate a habit of warming up the engine for several minutes irrespective of cold weather. If the vehicle is operated before the engine gets sufficiently warm, each part of the engine is adversely influenced because lubrication within the engine and fuel combustion are difficult to take place properly.

### Cylinder warm up

Before work begins every day, always make full stroke movement of the lift arm cylinders two or three times.

This movement enables the internal piston packing and cylinder to slide smoothly and puts the packing function in the same condition as during operation.

### Direction change

Operate two steering control levers as explained below.

#### 1. Slow turn

Varying the shift distances of the left and right steering control levers during forward or backward traveling makes the vehicle slowly turn to the side where the shift distance is smaller. The greater the difference between the shift distance of the two levers, the smaller the turning radius. The smaller the difference, the greater the turning radius.

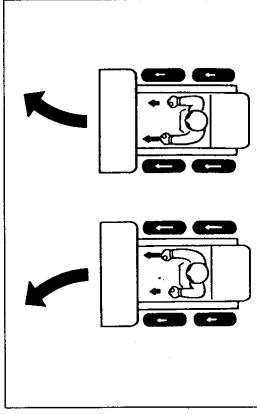

### Stopping the engine

1. Return the accelerator lever to the idle position and run the engine slowly for about 5 minutes, letting it gradually cool down.
2. Turn the engine switch to OFF and remove the key.

### Caution

**It is not good for the engine to be turned off suddenly while it is hot. Therefore do this only in an emergency.**

#### 2. Pivot turn

Operating only the left one of the two steering control levers makes the vehicle turn with the right tires as the center. Operating the right lever causes a left turn around the left tires.

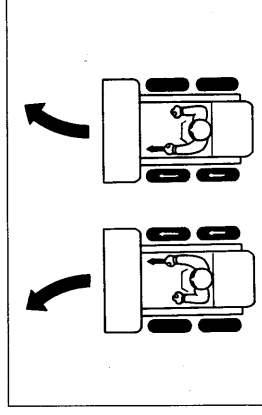

### Vehicle operation

#### Starting

1. Operate the lift and dump pedals to raise the bucket to 15—20 cm (6—7 in) above the ground.
2. Release the parking brake.
3. Push the accelerator lever forward to raise the engine speed.
4. Push left and right steering control lever simultaneously forward (or pull them backward) to make the vehicle travel forward (or backward).  
Infinite speed change in the range between 0 and the maximum speed is possible by the degree of lever pushing (or pulling).

#### Caution

- **Steering control levels at the time of starting shall be operated as slowly as possible.**

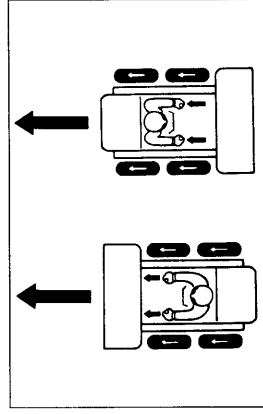

- **During traveling, set the accelerator lever at a fixed position and use the steering control levers for speed adjustment.**

#### 3. Spin turn

Operating the left and right steering control levers in the opposite directions makes the left and right tires rotate in reverse directions to cause the vehicle to turn around its center of gravity.

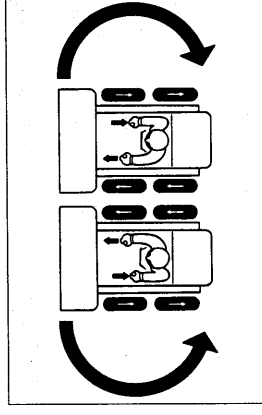

### Stopping and parking

- (1) To stop the vehicle, return the left and right steering control levers slowly to the neutral positions.

#### Caution

**Quick returning of steering control levers or operating them beyond the neutral positions to the reverse side of the traveling direction results in quick braking. Since this is very dangerous, never attempt such an operation unless in an emergency.**

- (2) When parking the vehicle, stop it on a solid, flat ground, bring the bucket down to the ground, apply the parking brake,

stop the engine, and remove the engine key.

#### Caution

**If circumstances do not allow to ground the bucket because of a malfunction or other reasons, park the vehicle at a place which is not near moving vehicles or pedestrians with a piece of red cloth attached to the tip of the bucket.**

**In such a case, make sure the lift arm is securely locked so that it is prevented from coming down either by locking it by means of the lift arm lock, the safety block, or the safety support.**

### Climbing out of the vehicle

When climbing out of the vehicle, use the assist grip and the step.

#### Caution

**Tires chains provide a large amount of traction to the vehicle but are of almost no help in preventing the vehicle from slipping sideways, so the vehicle must be driven cautiously.**

### Driving on snow or icy roads

If the vehicle is to be driven on snow or icy roads, tire chains should be used. Never apply the brakes suddenly as this may cause the vehicle to slip or skid in snow or ice. Sudden acceleration or turning is also dangerous and should be avoided.

Caution should also be exercised in operating the steering control levers.

### Bucket scoop operations

Move the vehicle forward slowly with the bucket held parallel to the ground or tilted slightly down, then raise the bucket by moving the tilt pedal towards the rear with your foot.

When the bucket is sufficiently full, tilt it back by moving the dump pedal towards the rear with your foot.

#### Caution

**Always scoop with the bucket moving parallel to the material to be scooped. Do not allow the bucket to tilt as this will put excessive strain on the arm, bucket, and other parts and damage them.**

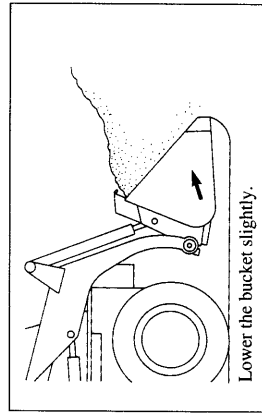
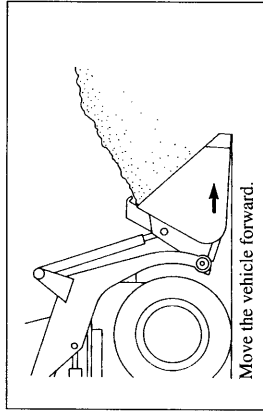
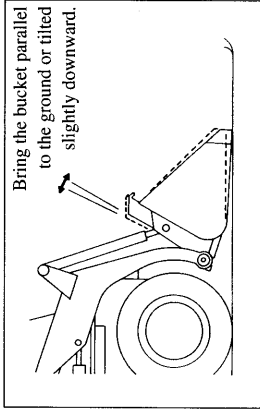

## MATERIALS HANDLING OPERATIONS

This vehicle is extremely effective in performing powerful hauling and loading. For safe, economical handling, the operator must have a thorough knowledge of operations and a good grasp of the construction and performance features of the vehicle. Then, on the job, he must choose the operating approach and match the actual conditions with outstanding driving and operation techniques.

Never put more demands on the vehicle than performance or capacities allow. This not only increases repair costs, it jeopardizes the safety of the operator and nearby workers as well. Any job must be undertaken with an eye on driver safety and others in the vicinity of the vehicle. Basic operation methods are explained here.

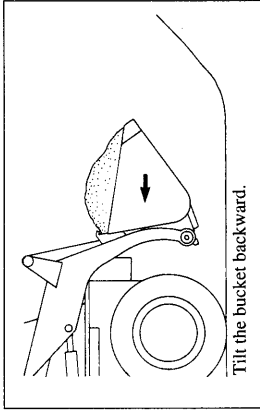

**Bucket scrape operations**  
 Advance with the bucket tilted down at the angle which ground hardness permits. Move forward slowly, letting the bucket scrape until it fills. Then, tilt back the bucket and haul away.

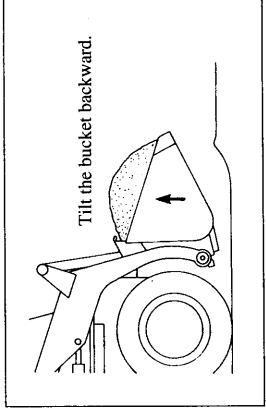
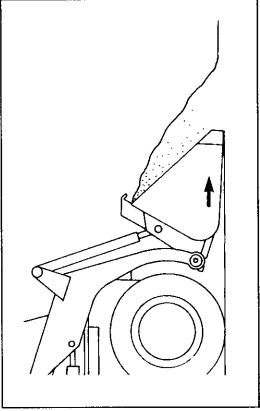
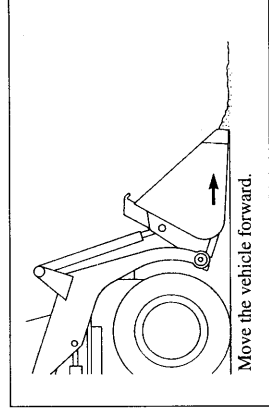
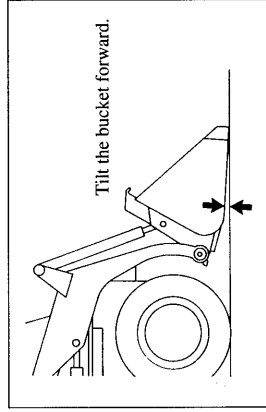

**Grading and levelling**  
 The bucket is tilted forward and raised slightly off the ground to perform grading and levelling jobs.

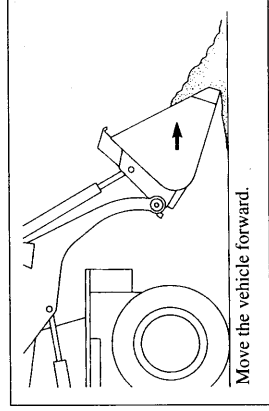



### Filling

Hole filling and similar operations are possible.

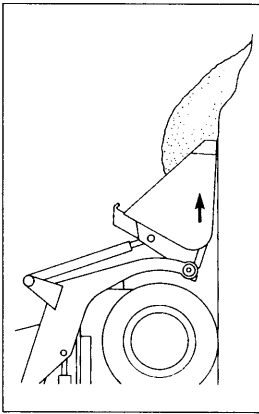

### Backfilling

Backfilling can be done by tilting the bucket forward and backing up with the edge slightly off the ground.

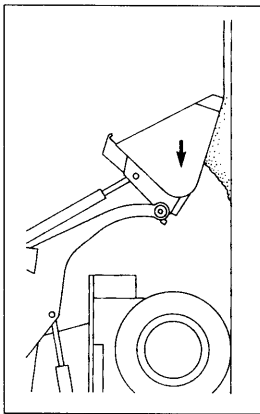

### Float position

It is sometimes easier to work with the arm in the float position.

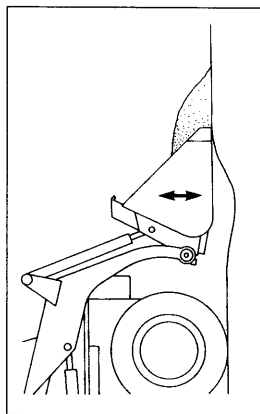

### Loading operations

Stop the vehicle near the truck and raise the bucket high enough to clear the upper edge of the truck.

Approach slowly, tilt bucket forward and stop vehicle.

Tilt the bucket forward to dump a bucketful in the truck.

The bucket may be used to level off the truck load.

To dislodge sticky material, shake the bucket up and down by gently moving the dump pedal back and forth.

### Caution

**Do not shake the bucket when unnecessary as this will put strain on the bucket stopper.**

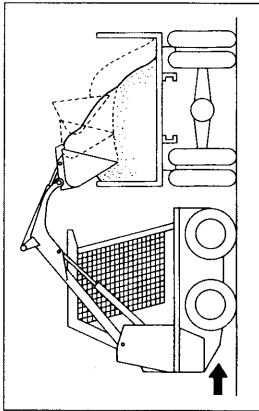

## HANDLING VEHICLE IN COLD SEASON

Pay attention to the following points in cold weather because starting difficulty or coolant freezing will occur.

### 1. Caution When Fueling

Always replenish fuel until the tank is full. In cold weather, it is advisable to keep fuel tank levels high.

### Caution

**Firmly tighten the tank cap to prevent rain or snow from entering.**

### 2. Caution for Cooling System

(1) Long-life coolant (LLC) 50% solution or antifreeze solution must be added to the cooling system (before outdoor temperature becomes lower than 0°C (32°F).)

### 3. Caution for Batteries

(1) In very cold weather, the battery performance is lowered and battery fluid may freeze if charging is insufficient. Try to keep the battery always in the fully charged state.

(2) If the vehicle is not to be used for a long period of time in very cold weather, remove the battery and store in a warm place.

(3) Immediately before using the vehicle (or immediately before charging), replenish refined water in an exceedingly cold place. (Exclusive of a maintenance-free battery)

(4) When it is difficult to start the engine, always do not apply hot water to the battery case to improve the battery performance. Pay special attention, because the case may be broken because of a change in temperature.

# HANDLING VEHICLE IN HOT SEASON

During hot weather, the following areas are of concern:

## Cooling unit

1. As water scale and rust easily take place in cooling system (especially in radiator) in hot season, remove water scale and rust with water or cleaning agent and always try to circulate clean water in the cooling system.
2. Clean radiator fins with compressed air to avoid clogging, resulting in overheating. Inspect the radiator for water leaks.

3. Inspect the fan belt for slack. If it is slack, adjust it to the prescribed tension.

4. When the engine is overheated and coolant boils, do not stop the engine immediately, but let it rotate at an idle speed for a while. After the water temperature drops, stop the engine. Also, open the engine hood to expedite cooling.

## Caution

**Do not remove the radiator cap to expedite cooling because it is very dangerous.**

## When it is difficult to start the engine

1. Do not use the starter motor continuously more than 30 seconds. When it is difficult to start the engine, stop the starter motor operation momentarily and wait until the battery restores to restart.
2. When it is difficult to start the engine, do not repeat the starting procedure many times but inspect whether there is fuel in the fuel tank, whether air is mixed in the fuel system and whether the glow plug is not disconnected.
3. The engine may not reach the starting rpm and start even if the starter motor is activated. In such a case, use an auxiliary battery to start the engine. Pay special attention not to connect mistakenly plus and minus terminals.

## After using vehicle

1. Clean off any mud or dirt that may be adhering to the vehicle and park the vehicle on a hard, dry surface such as concrete. If this is not done, the mud may freeze during the night and prevent the vehicle from being operated the next morning. This especially applies to the surface of the hydraulic cylinder piston rods: always dry these off, because the rod packing can be damaged if water gets into it and freeze.
2. Loosen the fuel tank drain plug and drain the water out of the fuel system to prevent it from freezing during the night.

## Caution

**When the cold season passes and the weather begins to warm up, bring the oil and fuel back up to standard specifications.**

## Starting in cold season

Low temperature causes battery performance to lower and viscosity of lubricating oil to increase, both of which make the engine starting more difficult.

In cold season, the engine is started in the following way:

1. Set the accelerator lever to maximum speed position.
2. Turn the ignition switch to GLOW and hold it there until the glow indicator lamp goes out (about 15 seconds after it comes on).
3. When the glow indicator lamp or goes out, turn the ignition switch to START and activate the starter motor.
4. If the engine does not start within 30 seconds, repeat steps (2) and (3).
5. When the engine starts, release the key switch immediately.
6. After the engine has started, pull back the accelerator lever, but not enough to cause the engine to stall.
7. As soon as the engine speed has stabilized, put the accelerator lever in the IDLE position and let the engine warm up for 10 or 15 minutes.

# LONG TERM STORAGE

## Before storage without operation

If the vehicle is to be stored for a long period of time, pay close attention to the following:

1. Carefully wash and clean each part.
2. Perform lubrication and oil change for all necessary parts without omission.
3. Apply grease thinly on the exposed portions of hydraulic cylinder piston rods.
4. If a long life coolant is not used, thoroughly drain the coolant from the cylinder block and radiator.
5. Remove the battery after full charging, and store it in a cool, dry place.
6. Pull the accelerator lever fully backward and keep the engine switch at the OFF position.
7. Store the vehicle indoors. If outdoor storage is unavoidable, place the vehicle on blocks and cover with waterproof canvas.

## During storage

During storage, run the engine, move the vehicle back and forth, and operate each pedal at least once a month for lubrication of each part.

## Caution

**When operating hydraulic cylinders, wipe off grease applied to piston rods. Charge the battery fully when the engine is operated. (Supplementary charging is necessary every month to prevent degradation due to self-discharge).**

## After long storage

Pay attention to the following points when operating the vehicle that has been stored for a long period without operation.

1. Remove the drain plug from the fuel tank, oil pan, etc., to drain water accumulated in each part.
2. After starting the engine, carry out sufficient warm up and inspect each part carefully.

# TRANSPORTATION

Use of a special platform is desirable for loading-unloading of the vehicle for transportation. When gangplanks have to be used, try safe operation, paying attention to the following points.

1. Stop the engine, apply the parking brake and block tires of the truck.
2. Set left and right gangplanks so that the truck and the vehicle are centered.

**Caution**

Use 450 mm or wider gangplanks which can sufficiently endure the vehicle weight. Fasten them firmly to the truck bed by using proper fittings. Install them without level difference between the left and right, and limit the board inclination within 15°.

3. Adjust the vehicle direction before getting on the gangplanks, and load the vehicle slowly by backward traveling.

**Caution**

- Never change the direction on the gangplanks.
- Always assign a guide and carefully operate for ascending and descending on the gangplanks.

4. Apply the parking brake, fix the vehicle body to the truck bed with wire ropes and use wheel blocks to prevent vehicle movement during transportation. Bring the bucket into close contact with the truck bed.

Fix the body to the truck bed as described below.

(Front side)

Pass wire ropes through holes on both sides of the liftarm, and fix the body firmly to the truck bed.

(Rear side)

Pass a wire rope through the left and right rear hooks for fixing to the bed.

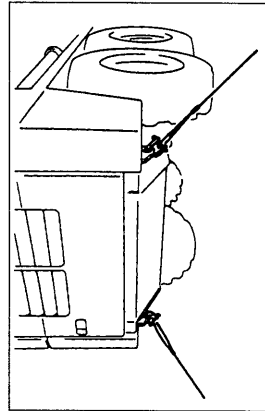
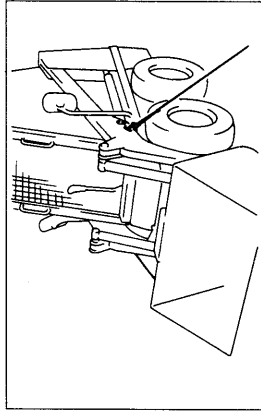
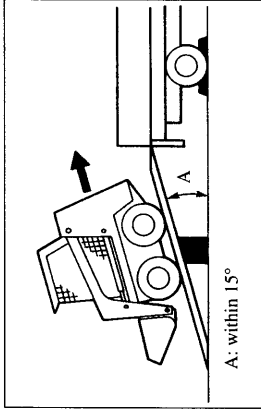

# SELF SERVICE

**Tools**

Standard tools in the bag for before-operation inspection and simple service are delivered to the user of the Toyota Skid-Steer Loader. Use these tools in your everyday inspection and service.

**Repairing flats, Replacing tires**

1. Preparations  
Prepare tools and the jack, and securely block the wheels.  
Front Wheel
  - (1) Dump the load, move the vehicle to a level area, and lower the bucket until it touches the ground.
  - (2) Slightly loosen the hub nuts.
  - (3) Tilt the bucket forward, and with the tires off the ground, put blocks under the frame.
  - (4) Remove the hub nuts and the wheel.
  - (5) To re-install the wheel, reverse the removal procedure. Tighten the hub nuts evenly in the order shown in the illustration.
  - (6) After installing the wheel, check the tire pressure and adjust it if necessary.

**Note**

See the Service Data for tightening torque of hub nuts and tire pressure.

3. Rear Wheel
  - (1) Locate the vehicle on level ground.
  - (2) Apply the parking brake, securely block the wheels and slide the jack under the frame.
  - (3) Jack up the vehicle until the tires are in light contact with the ground and loosen the hub nuts.
  - (4) Jack up the unit until the tire is off the ground, remove the hub nuts, and then remove the rear wheels.
  - (5) After tire repair or replacement of tire, reverse the removal procedures to mount the tire and wheel. Tighten the hub nuts as shown in "Font Wheel" section.

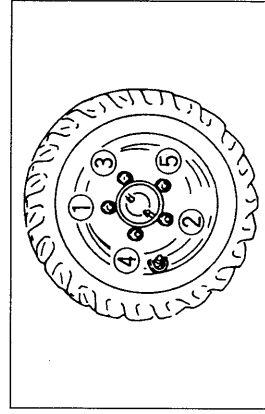
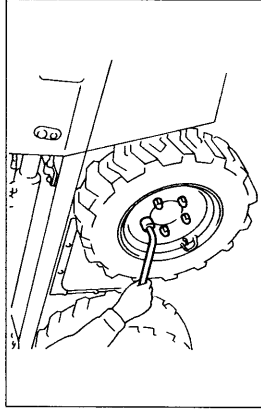

### Tire rotation

Rotate the tires as shown when they show wear. Note that the direction of the tire patterns of the left and right tires will become reversed when the tires are rotated.

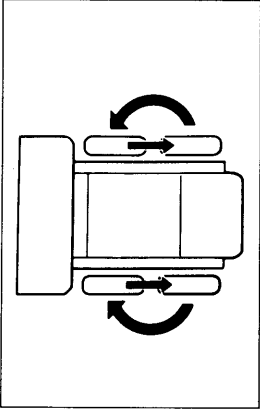

### Towing the vehicle

If it becomes absolutely necessary to tow the vehicle, the bypass valve on the HST pump needs to be loosened 3 to 4 turns. Use the rear frame hook for towing and tow at a very low speed.

**ATTENTION:** Do not push or tow vehicle long distances as internal transmission damage will result. Load vehicle on a trailer or truck when transporting.

**CAUTION:** Do not turn valve while engine is running. Do not tow vehicle to start.

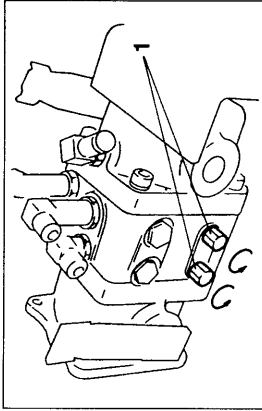

1. Bypass valve

### Replacement of bucket

#### Removing the bucket

1. First move the vehicle to a level and safe place, and then make the bucket level and ground it.
2. Stop the engine
3. Climb out of the vehicle after making sure that the material handling pedal is fixed.
4. Bring down the bucket lock lever.

#### Caution

**Make sure the pins at the both sides of the bucket bracket have been removed completely from the bucket.**

5. Climb into the vehicle, and start the engine.
6. Slightly lift the lift arm simultaneously slightly tilting the bucket in the forward direction and then move the vehicle backward as it is.

#### Mounting the bucket

1. Tilt the bucket bracket in the forward direction, bring the center of the bucket into the center line of the vehicle, and move the vehicle until it touches with the bucket.
2. Slightly raise the lift arm and tilt it to the backward.

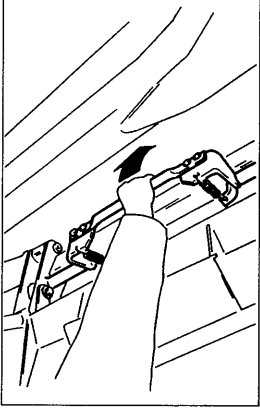

3. Stop the engine, and climb out of the vehicle after making sure that the material handling pedal is securely locked.
4. Lift the bucket lock lever to lock the bucket.

#### Caution

- **Make sure the bucket is securely fixed.**
- **Never mount or demount the bucket with the lift arm at a raised position.**

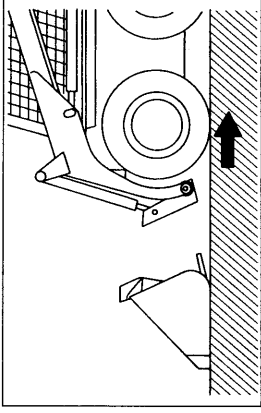

### Air purge of the fuel system

When fuel has been completely depleted or when maintenance has been performed on the fuel system, be sure to perform air purge in the following sequence.

1. While moving fuel pump lever (4) up and down, loosen air bleeding bolt (1) on the top of the fuel filter and bleed the air.
2. Next do the same for air bleeding bolt (2) on top of the fuel filter and air bleeding bolt (3) on the fuel injection pump and bleed the air.
3. Loosen nuts (5) on the injection nozzle side of the fuel pumps for all cylinders and crank the engine.
4. Bleed the air from the fuel system using steps 1 through 3.

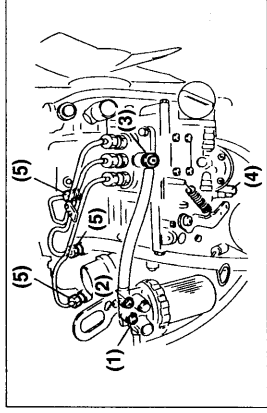

(4SDK3)

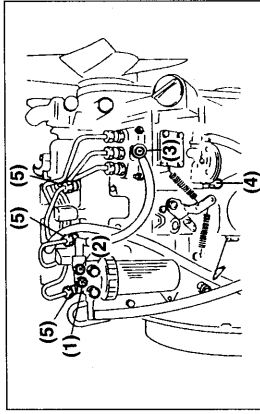

(4SDK4)

### Fuse replacement

The fuse box is installed at the upper side of the engine.

If the device or unit assigned to each unit does not function, the fuse may be blown. Take the following actions.

1. Turn the engine switch to the OFF position.
2. Remove the fuse box cover, and take out the fuse clip located on the inside of the cover.
3. Hook the fuse clip on the fuse and remove the fuse.
4. The fuse is blown if it is as illustrated at right.

Replace the fuse with a spare one.

### Adding antifreeze

If the vehicle is left in an area where the temperature is less than 0°C (32°F), the cooling water will freeze and may damage the radiator and/or cylinder block if antifreeze is not added.

When long-life coolant (LLC) is used, it must be changed once every two years.

Freezing temperature varies depending on the amount of antifreeze added.

Antifreeze solution mixing capacity (%)

Antifreeze temperature (°F)	10.4	5	-11.2	-31
Antifreeze temperature (°C)	-12	-15	-24	-35
Mixing ratio (%)	25	30	40	50

### Caution

**Prior to adding antifreeze, inspect the radiator, water pump, piping and block for leaks. The procedures for adding antifreeze are as follows.**

1. Remove the radiator cap, loosen the drain cock on the radiator and engine block and drain the cooling water.
2. Flush out the radiator and cylinder block by adding clean water through the radiator inlet.
3. After the water has drained out of the radiator and engine block, fully tighten the radiator and engine drain cocks.
4. Add the proper amount of antifreeze to the radiator inlet and fill up the remaining space with water.
5. Also change the coolant in the reserve tank, adding water and antifreeze in the same proportion.

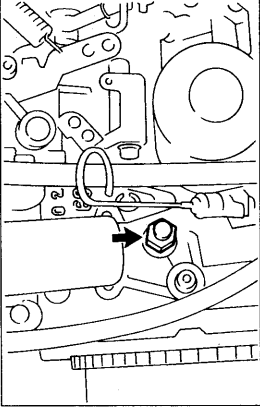

(4SDK3)

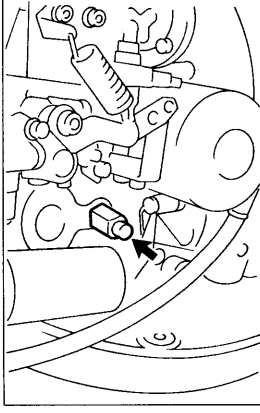

(4SDK4)

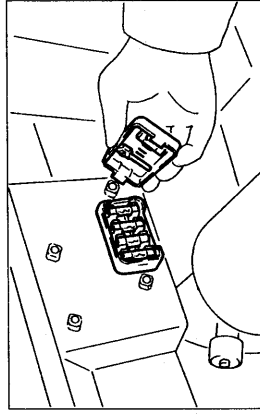

### Caution

- Use the fuse having the same capacity as that of the installed fuse.
- If the replaced fuse is blown again, have the vehicle inspected.

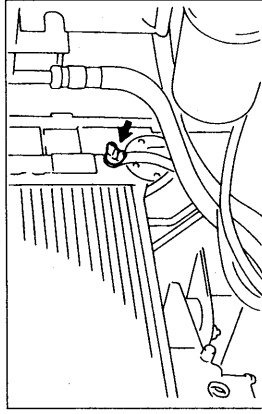

# PRE-OPERATION CHECK

## Pre-operation check

Pre-operation checks and weekly inspections are the responsibility of the Toyota industrial vehicle user.

Be sure to perform a pre-operation check before beginning work to ensure safety.

Item	Inspection
Previously detected malfunctions	Correct.
Exterior	Vehicle posture, oil leakage, water leakage, loose parts, exterior damage.
Wheels	Tire pressure, wear or damage, rims, hub nuts.
Lamps	Lamp condition, damaged lamps.
Hydraulic oil	Oil level, contamination, consistency.
Radiator	Coolant level, LLC or antifreeze requirement.
Engine	Oil level, contamination, consistency, noise, exhaust.
Parking brake	Pull reserve, braking action.
Levers	Looseness, functioning.
Horn	Sound.
Instruments	Functioning.
Load handling system	Parts, oil leakage, cracking, looseness.
Fuel	Amount.
Pedal lock	Functioning & correct operating
Seat belt - Seat bar	Functioning & correct operating (including the metal fittings).
Operator guard	Any damage and deformation, mounting bolts for any looseness.

## Walkaround inspection

### Vehicle uprightiness

Does the vehicle lean to one side or the other? If so, check for a tire puncture or a problem with the undercarriage.

### Beneath the vehicle

Check for any oil or water leakage on the ground or floor where the vehicle was parked. Check for loose parts or damage.

If any unusual condition is found, have the vehicle repaired.

## Tire inspection

Always maintain proper air pressure. Low pressure shortens tire life and increases fuel consumption.

A difference in right and left pressure will make it difficult to steer. Turn the valve cap to the left and remove it.

Use a tire pressure gauge to check the pressure and adjust to the proper level.

Refer to the service data for proper air pressure.

After checking the pressure, make sure there is no air leaking from the valve then replace the valve cap.

If there is any difference in tire wear between the front and rear or left and right tires or if damage or a bent rim is found, it is recommended to have the vehicle inspected at a service station.

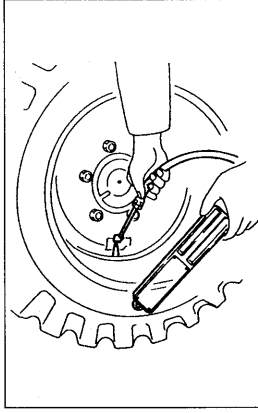

**Caution**  
When adjusting the air pressure, pay attention to deformation or crack of rims.

Never exceed recommended pressure. Failure to regulate the air compressor before inflating tires is dangerous. The air pressure in the tire may exceed the recommended pressure causing the tire to explode.

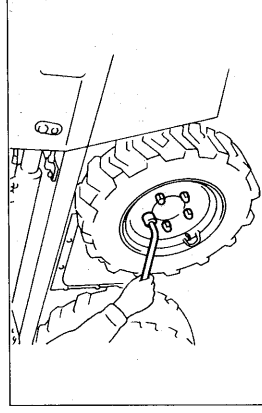

## Hub nut inspection

Check the tightness of the hub nuts.

Avoid uneven torque and tighten all of the nuts uniformly. Even a slightly loose nut is dangerous. Refer to service data for proper torque.

### Lamp inspection

Are the filaments intact? Is there any lens damage?  
Always keep the lenses clean to insure proper forward vision.

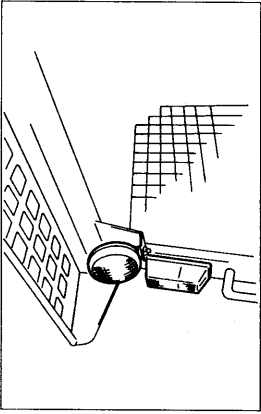

### Note

Inspect the oil level with the oil level cap screw against the retainer port, as shown in the diagram.

3. Remove the level gauge and check that the position of the oil is within the range indicated on the level gauge.
4. If the oil is low, replenish.

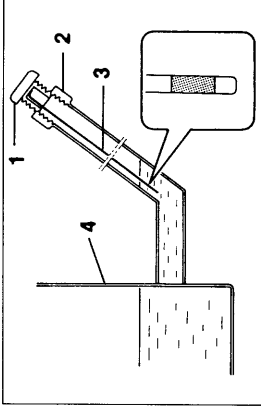

1. Oil cap
2. Retainer
3. Level gauge
4. Oil tank

### Engine compartment inspection

#### Operator guard inspection

Check the operator guard for any damage or deformation.  
Also check the locking bolts for any looseness.

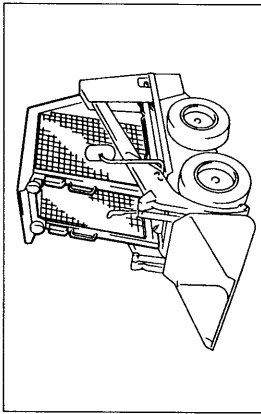

#### Coolant inspection

Open the engine hood and inspect the level line in the reserve tank installed at the engine side.  
Coolant inspection and replenishment shall be carried out when the coolant temperature is low.

If the coolant is near the "LOW" line, replenish clean water (soft water) up to the "FULL" line.

If antifreeze solution is used for the coolant, replenish antifreeze solution with the same concentration.

Make sure that the radiator cap is tightened securely; if this is not done, vacuum build-up can also cause coolant to be lost from the radiator.

Remove the radiator cap by turning it counterclockwise 90° and look into the radiator. If you cannot see any coolant, fill the radiator all the way to the top of the inlet with clean soft water. To replace the cap, align the catch on the underside of the cap with the notch in the lip of the radiator inlet, push down, and turn the cap clockwise as far as it will go.

### Caution

Removing the radiator cap when the engine is hot can be dangerous, so always turn the cap slightly first and allow the pressure to escape before removing the cap.

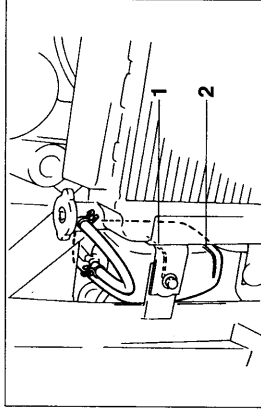

1. Full
2. Low

#### Hydraulic Oil Inspection

### Note

Inspect the hydraulic oil in a flat place with the bucket level, the arm fully lowered, and the engine stopped.

1. Open the rear grille and remove the oil cap.
2. Wipe the level gauge attached to the cap with a clean cloth and reinsert it into the tank.

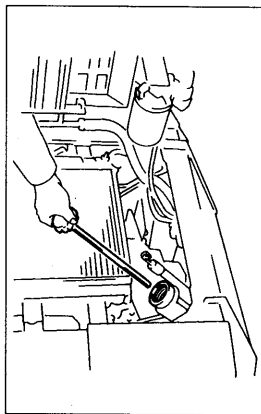

If the coolant level drops within a short time after replenishing, there may be a leak in the system. Visually check the radiator, hoses, radiator cap and drain cock, and water pump. If no leak can be found, have the cap pressure tested at your Toyota dealer.

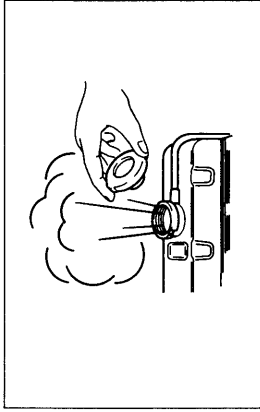

### Engine oil inspection

Check the engine oil capacity before starting the engine.

Withdraw the oil level gauge, wipe with a clean cloth and reinsert all the way. Withdraw carefully and check the level up to which the oil adheres. If the level is between "F" and "L" or on level line, it shows a proper quantity.

#### Caution

Check the oil when the vehicle is parked on the surface.

As the accurate level cannot be obtained when it is checked immediately after the engine stops, wait three minutes.

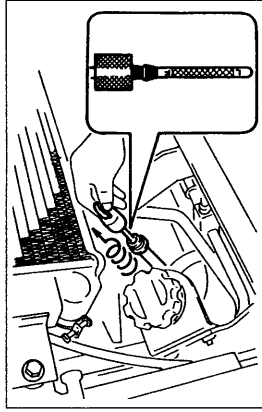

### Engine oil replenishment

If the oil is near "L" level when checking, replenish to the "F" level.

Remove the oil filler cap by turning it to the left and pour through it. Be careful not to pour more than "F" level. Use the engine oil fit for the season.

#### Caution

Use the same brand engine oil when replenishing whenever possible.

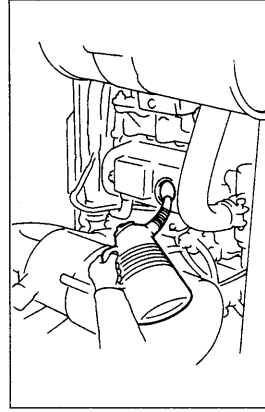

### Leakage inspection

Check the engine compartment for any oil or fuel leakage.

Clean the radiator if it is clogged and check if there are any foreign objects, such as paper or other, onto the radiator grill.

### On board vehicle inspection

#### Step and step handle inspection

Wipe mud, oil, grease, etc. off the step to cabin, grip, hand rail, floor surface and each pedal to prevent slipping.

Pay special attention to ice and snow in cold season.

Always use the step and step handle installed on the vehicle as care must be taken not to slip and get hurt. Wipe oil and grease off your hands or mud off your shoes and slowly and safely get on the vehicle.

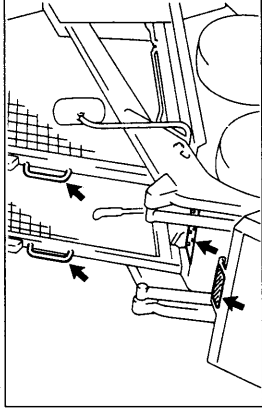

#### Parking brake inspection.

Push the parking brake all the way in. Check that the parking brake is securely locked.

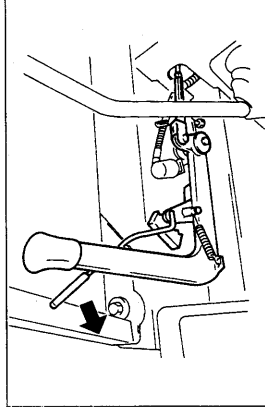



### Pedal lock function check

1. Sit down on the operator's seat and make sure the material handling pedal is immovable by pressing it.
2. Next, make sure the material handling pedal will become movable following the release of the pedal lock when the ignition switch is turned ON after the operator has lowered the seat bar.  
A Metallic sound can be heard when the pedal lock is activated.
3. Make sure the pedal lock is fixed when the seat bar is raised until unlocking under the condition described in preceding item 2.
4. Make sure the material handling pedal will come to be fixed about a second after the operator has risen from the operator's seat under the conditions described in the above-mentioned item 2.
5. Make sure the material handling pedal will come to be fixed when the ignition switch has been turned OFF under the conditions described in the item 2.
6. If any abnormality is observed, have the vehicle checked by the service outlet.

### Checking the seat belt

Check the seat belt for any damage or normal operation. Replace the seat belt whenever the seat belt is found to have a fray or worn off, or a malfunction occurs in the metal fitting section.

### Checking the seat bar

Check the seat bar for any damage or normal operation.

Also check the locking bolts for any looseness.

### Caution

**Do not operate with the seat bar removed.**

### Fuel level inspection and refueling

Check the amount of fuel using the fuel gauge. Fill with sufficient fuel for one day's work.

### Fuel tank cap

Turn the fuel tank cap to the left to remove it. There is a breather valve installed inside the cap.

If this valve is damaged or missing, the fuel may spray out.

### Caution

- Never refuel near an open flame. Stop the engine before refueling.
- Retighten the cap securely after refueling.
- Do not allow water or dirt to get into the fuel.
- Fill the fuel tank every day after work to prevent moisture in the air from condensing and mixing with the fuel.

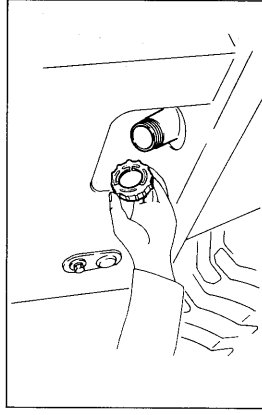
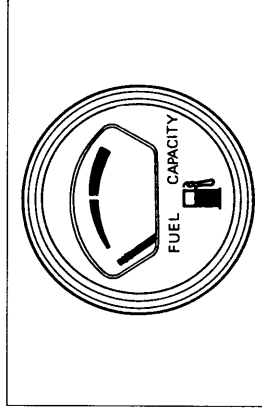

### Starting the engine

### Instrument inspection

Instruments are to know a state of the vehicle in operation.

Each warning lamp goes on by switching ON the ignition switch. Inspect whether the warning lamp normally goes off after the engine is started. Make sure that the hour meter also is operating normal.

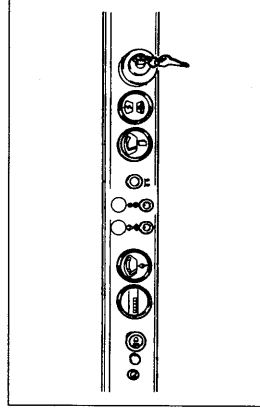

### Engine inspection

Sit down on the driver's seat. Make sure that each lever is placed in neutral position and the parking brake is workable before starting the engine.

After engine starting, make sure that each instrument and warning lamp is normal. Conduct enough warming up and inspect the engine in operation for abnormal sound, vibration and strange exhaust color.

Colorless or light blue . . . Perfect combustion  
Black . . . . . Improper combustion

White . . . . . Oil drawn up (or down) into the combustion chamber

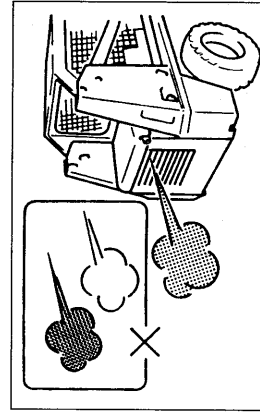

**Caution**

The exhaust gas is very dangerous. When the engine must be started in a building or in a closed place, pay special attention to ventilation and put the vehicle outdoors as soon as possible for inspection. Pay special attention to fire.

Pay special attention to oil, fuel leaks, and paper in the engine compartment. Confirm whereabouts of a fire extinguisher and how to use it, etc.

**Loading inspection**

Inspect whether the bucket is firmly attached and whether there is any crack or bending. Is there any distortion in the arm? Any bending in the ring rod? Any oil leak from the cylinder and piping?

Operate the lift and dump pedal to make sure that each part is smoothly operating. If any abnormality is found in the above inspection, have the vehicle repaired.

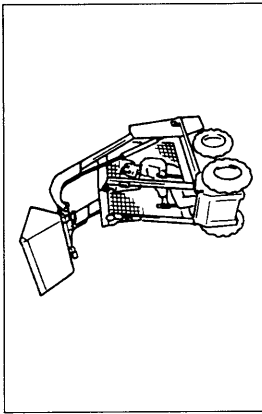

**While moving the vehicle**

**Steering control lever inspection**

While the vehicle is being driven slowly by operating the steering control lever in a safe place, inspect it for abnormality when the vehicle is spinned to the left or right by operating the lever alternately. Also, inspect whether the lever automatically returns and the vehicle stops when the lever is released. Moreover, inspect speed change and switchover between forward and reverse by a degree of shifting the lever. If any abnormality is found, have the vehicle repaired.

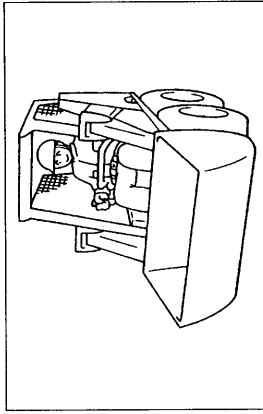

**Braking effect**

Apply the parking brake lever and make sure that the vehicle parking position can be maintained.

**Caution**

When any slight abnormality is found, stop operation immediately. Report to the person in charge to the effect and ask our service shop for inspection.

## BEFORE STORING THE VEHICLE

Before storing the vehicle, clean each part and inspect the following:

1. Oil or water leakage from componentry.
2. Distortion, damage, bending, cracks in parts.
3. Clean the air cleaner element and grease parts.
4. Report to the person in charge any abnormalities discovered in the course of this inspection.

**Caution**

Do not operate the vehicle until repairs have been completed.

## WEEKLY MAINTENANCE

INSPECTION AND SERVICE ITEMS	REMARKS
Replacement of HST oil filter Air cleaner cleaning Tightening of bolt and nut Arm system lubrication Fan belt inspection Draining of fuel tank water-mixing, sediment.	New vehicle

Inspect the items below in addition to the pre-operation items. Have necessary adjustments or replacements performed.

Please inspect the vehicles thoroughly to insure safety and pleasant working conditions.

### HST oil filter replacement

The HST oil filter should of course be replaced whenever the HST filter warning lamp goes on, but it should also be replaced after 50 hours the first time and after 500 hours (or 1 year) thereafter, regardless of whether the warning lamp lights or not.

### Oil filter replacement.

1. Release the rear grille.
2. Use a filter wrench to remove the oil filter.

### Caution

**Be careful not to let dust or dirt into the circuit.**

3. Install the new oil filter.

### Note

- Clean the surface of installation.
- Apply new hydraulic oil to the filter gasket.
- Rotate approximately 2/3 rotation after the oil filter's gasket comes into contact with the filter head.

At the same time that the filter is replaced, the warning lamp should be checked to make sure that it has not burnt out.

It is recommended that the hydraulic oil also be changed whenever the HST oil filter is replaced due to the warning lamp going on.

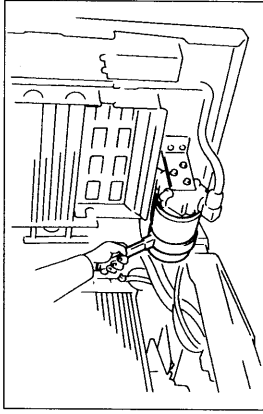

### • Washing the element

1. Dissolve a neutral cleaning agent in warm (about 40°C.) water, soak the element in this cleaning solution for 15 or 20 minutes, and then wash it. Check to see that the filter paper has not become torn.
  2. After washing the element, rinse it well in clean water.
  3. Dry it off by letting it dry by itself or by using a cold-air dryer. Never dry the element with compressed air or fire.
- **Cleaning the air cleaner cap**

Remove the dust cup and remove any dirt in the air cleaner cap.

### Caution

**When installing the air cleaner cap, make sure that the arrow mark on the cap points up then install it.**

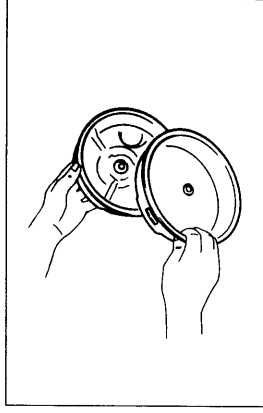

### Air cleaner cleaning

Clean the air cleaner as soon as needed. Remove the air cleaner dust-cap, remove the wing nut which holds on the element, and take out the element.

### • Cleaning the element

For normal cleaning, blow out the air cleaner from inside the element with compressed air (7-kg/cm<sup>2</sup> (99 lbs) or less), or tap it lightly and knock out the dust.

If the element is extremely dirty, it can also be washed. Replace the element after 6 washings or 1 year.

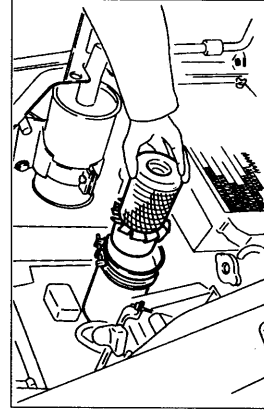

### • Dust indicator

The dust indicator shows clogging of the air cleaner element.

When a red mark can be seen in the inspection window, it indicates that cleaning is required.

After cleaning the element, press the reset button to reset the indicator.

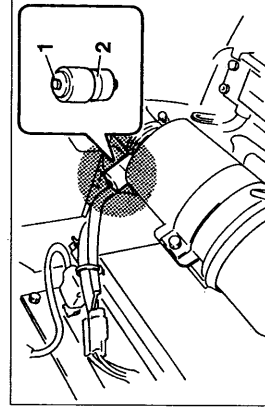

1. Reset button
2. Inspection window

### Fan belt inspection

If abnormality such as a crack and fray is found on the fan belt or its tension is weak, ask our service shop for replacement or adjustment. Refer to service data for tension.

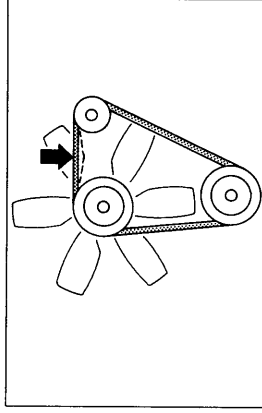

**Draining of fuel tank water-mixing.**  
If you loosen the drain plug in the lower part of the fuel tank, the sediment and mixed water accumulated in the tank will be disposed together with the fuel.

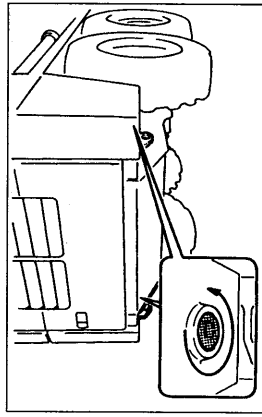

### Battery electrolyte check

1. The battery electrolyte should be between the upper and lower levels (10 to 15 mm from the top of the plates).
2. If the electrolyte level is below the lower level, remove the cap and add distilled water to the upper level through the water inlet port.

#### Caution

Be sure to use distilled water for battery electrolyte. Also, wear protective glasses when working on the battery.

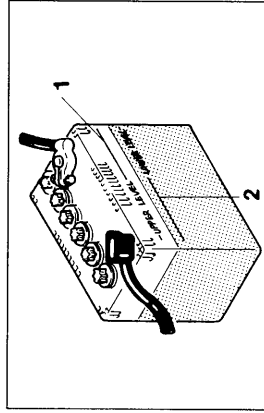

1. Upper level
2. Lower level

### Lubricating the arm system

Sufficiently lubricate the arm and cylinder portion joint pin.

#### Caution

- (1) Clean off the grease fitting nipples before lubricating.
- (2) After lubricating, carefully remove any leftover grease.

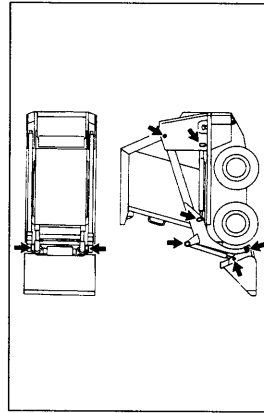

### Tightening of nuts and bolts

Tighten all engine, chassis, and material-handling system nuts and bolts.

## PERIODIC MAINTENANCE

Periodic inspection and maintenance are necessary to keep your Toyota industrial vehicle running smoothly. The designated number of hours in the inspection cycle are as follows.

**Daily (pre-operation check)** . . . Every 8 hours  
**Weekly** . . . . . Every 40 hours  
**Monthly** . . . . . Every 170 hours  
**3 month** . . . . . Every 500 hours  
**6 month** . . . . . Every 1,000 hours  
**Annually** . . . . . Every 2,000 hours

If operation time exceeds 170 hours in a month use the number of hours as the guide

for performing periodic inspection. Preoperation checks and weekly inspections should be performed by the user. Monthly, 3 month, 6 month and annual inspection should be performed by a Toyota Dealer since high-level technology and special tools are required. Refer to the periodic table to determine inspection and maintenance items and inspection cycles. Use only genuine Toyota parts for replacement parts, and use the recommended types of lubricants.

# PERIODIC REPLACEMENT TABLE

## PERIODIC REPLACEMENT TABLE

### REPLACEMENT PERIOD

Carry out according to operating hours or months, whichever comes soonest.

Replacement Item	40 hrs.	Monthly services (170 hrs.)	3-month services (500 hrs.)	6-month services (1000 hrs.)	Annual services (2000 hrs.)	Remarks
Engine Oil		●	←	←	←	
Engine Oil Filter		● (New vehicle)	●	←	←	
Coolant (Excluding LLC)			●	←	←	Replace LLC every 2 years
Air Cleaner Element					●	Replace every 6-times cleaning
Fuel Filter				●	←	
Fuel Filter Element				●	←	
Hydraulic Oil			●	←	←	
Reduction Device Oil				●	←	
HST Oil Filter	● (New vehicle)					Replace by warning lamp indication
Fuel hose						● Replace every 2 years
Hose for Loading						● Replace every 2 years
Hose for HST						● Replace every 2 years

# PERIODIC MAINTENANCE TABLE

## Periodic maintenance INSPECTION METHOD

I: Inspect and correct and replace as required. T: Tighten C: Clean L: Lubricate M: Measure and correct and adjust as required.

INSPECTION PERIOD (Accomplish based on operating hours or months, whichever is soonest.)	EVERY		170		500		1000		2000	
	EVERY	MONTHS	1	3	6	12	MONTHS	HOURS	HOURS	HOURS

### ENGINE

#### Basic components

- Starting condition and unusual noise..... I ← ← ← ←
- Rotating condition during idling..... M ← ← ← ←
- Rotating condition during acceleration..... M ← ← ← ←
- Exhaust condition..... I ← ← ← ←
- Air cleaner element..... C ← ← ← ←
- Valve clearance..... M\* ← ← ← ←
- Compression..... M ← ← ← ←

#### Governor

- Maximum no-load stabilized rotation speed..... M ← ← ← ←

#### Lubrication system

- Oil leakage..... I ← ← ← ←
- Oil level..... I ← ← ← ←
- Clogging and fouling of oil filter..... I ← ← ← ←

#### Fuel system

- Fuel leakage..... I ← ← ← ←
- Fouling and damage of fuel filter element..... I ← ← ← ←
- Injection timing..... M ← ← ← ←
- Injection nozzle injection pressure and condition..... M ← ← ← ←

#### Cooling system

- Radiator cooling water level and leakage..... I ← ← ← ←
- Rubber hose deterioration..... I ← ← ← ←
- Radiator cap condition..... I ← ← ← ←
- Fan belt tension and damage..... I ← ← ← ←

INSPECTION PERIOD (Accomplish based on operating hours or months, whichever is soonest.)

EVERY	1	3	6	12
EVERY	170	500	1000	2000

### POWER TRANSMISSION SYSTEM

#### HST Pump and Motor

- Oil leak..... I ← ← ← ←
- HST pump and motor operation, abnormal sound..... I ← ← ← ←
- HST charge pressure measurement..... M ← ← ← ←

#### Reduction Device Unit

- Oil leak..... I ← ← ← ←
- Oil level..... I ← ← ← ←
- Reduction gear operation, abnormal sound..... I ← ← ← ←
- Chain bushing engaged portion deformation..... I ← ← ← ←
- Sprocket deformation, damage..... I ← ← ← ←

### RUNNING EQUIPMENT

#### Wheels

- Tire air pressure..... M ← ← ← ←
- Tire cuts, damage and uneven treads..... I ← ← ← ←
- Loose hub bolts and hub nuts..... T ← ← ← ←
- Tread depth..... M ← ← ← ←
- Metal fragments, stones or other foreign objects in tires..... I ← ← ← ←
- Rim, side ring and disc wheel damage..... I ← ← ← ←
- Wheel bearing unusual noise and looseness..... I ← ← ← ←

#### Axle

- Deformation crack and damage..... I ← ← ← ←

### STEERING SYSTEM

#### Steering Control Lever

- Looseness..... I ← ← ← ←
- Operation condition..... I ← ← ← ←

#### Link Rod

- Bending and damage..... I ← ← ← ←
- Installed portion looseness..... I ← ← ← ←

INSPECTION PERIOD (Accomplish based on operating hours or months, whichever is soonest.)	EVERY	1	3	6	12
	EVERY	170	500	1000	2000

INSPECTION PERIOD (Accomplish based on operating hours or months, whichever is soonest.)	EVERY	1	3	6	12
	EVERY	170	500	1000	2000

**BRAKING SYSTEM**

**Parking brake**

1. Pull margin .....	I	←	←	←	←
2. Braking effect .....	I	←	←	←	←
3. Rod and cable looseness and damage .....	I	←	←	←	←
4. Ratchet wear and damage .....					I

**Disk brake**

5. Brake disk and pad wear and damage .....					M
---	--	--	--	--	---

**MATERIALS HANDLING EQUIPMENT**

**Bucket**

1. Bucket edge damage, wear .....	I	←	←	←	←
2. Bucket deformation, damage and crack .....	I	←	←	←	←
3. Bucket welded portion crack .....					I

**Lift Arm and Link**

4. Lift arm and link deformation, damage and crack .....	I	←	←	←	←
5. Lift arm welded portion crack .....					I

**Bucket Bracket**

6. Stop lever, link and pin damage .....	I	←	←	←	←
7. Bucket bracket deformation, damage and crack .....	I	←	←	←	←
8. Bucket bracket welded portion crack .....					I

**Various Kinds of Attachments**

9. Any abnormality and installed state of each part .....	I	←	←	←	←
---	---	---	---	---	---

**HYDRAULIC EQUIPMENT**

**Cylinder**

1. Cylinder installed portion looseness .....	T	←	←	←	←
2. Cylinder and piston rod damage .....	I	←	←	←	←
3. Rising speed, dumping speed .....	M	←	←	←	←
4. Cylinder operating condition, natural drop, natural forward tilt .....	M	←	←	←	←
5. Cylinder oil leak .....	I	←	←	←	←
6. Pin and cylinder bearing wear, damage .....	I	←	←	←	←

**Oil Pump**

7. Oil leak, abnormal sound .....	I	←	←	←	←
-----------------------------------	---	---	---	---	---

**Hydraulic Oil Tank**

8. Oil amount and dirt .....	I	←	←	←	←
9. Oil leak .....	I	←	←	←	←
10. Tank and strainer .....	C	←	←	←	←

**Operating Pedal**

11. Each connecting portion looseness .....	I	←	←	←	←
12. Pedal function .....	I	←	←	←	←
13. Pedal lock function .....	I	←	←	←	←

**Oil Control Valve**

14. Oil leakage .....	I	←	←	←	←
15. Safety valve function .....	I	←	←	←	←
16. Relief pressure measurement .....					M

**Hose, Piping**

17. Oil leak, looseness deformation damage .....	I	←	←	←	←
--	---	---	---	---	---

**ELECTRIC EQUIPMENT**

**Starter**

1. Pinion gear meshing .....	I	←	←	←	←
------------------------------	---	---	---	---	---

**Charger**

2. Charging function .....	I	←	←	←	←
----------------------------	---	---	---	---	---

**Electric Wiring**

3. Wire harness damage and connector looseness .....	I	←	←	←	←
4. Fuses .....	I	←	←	←	←

**Pre-heater**

5. Glow plug heat coil breakage .....					I
6. Intake heater .....					I

**Battery**

7. Battery electrolyte level .....	I	←	←	←	←
8. Specific gravity .....					M

**INSPECTION PERIOD** (Accomplish based on operating hours or months, whichever is soonest.)

EVERY 1 3 6 12 MONTHS  
EVERY 170 500 1000 2000 HOURS

**SAFETY DEVICE AND OTHERS**

**Operator Guard and Side Guard**

- 1. Installed portion looseness ..... T ← ← ← ←
- 2. Deformation, crack, damage ..... I ← ← ← ←

**Direction Indicator**

- 3. Operation and installed state ..... I ← ← ← ←

**Alarm Unit**

- 4. Operation and installed state ..... I ← ← ← ←

**Lamp Unit**

- 5. Operation and installed state ..... I ← ← ← ←

**Reverse Alarm**

- 6. Operation and installed state ..... J ← ← ← ←

**Back Mirror (Option)**

- 7. Dirt and damage ..... I ← ← ← ←
- 8. Back reflection state ..... I ← ← ← ←

**Instruments**

- 9. Each instrument operation ..... I ← ← ← ←

**Seat**

- 10. Looseness, damage ..... I ← ← ← ←

**Seat Belt**

- 11. Slackness, damage ..... I ← ← ← ←

**Seat bar**

- 12. Looseness, damage ..... I ← ← ← ←

**Body**

- 13. Frame, cross member, etc. damage, crack ..... I
- 14. Bolt looseness ..... T

**Others**

- 15. Each part grease up ..... L ← ← ← ←

\* For new vehicle



# SERVICE DATA

## Adjustment value table

Item	4SDK3	4SDK4
Fan belt tension (10 kg pressure applied)	10 (0.39)	←
Fuel injection timing (BTDC) (Stationary)	16°	←
Fuel injection sequence	1-3-2	←
Valve clearance		
Intake	0.2 (0.008) (Cold)	←
Exhaust	0.2 (0.008) (Cold)	←
Idling speed	800±50	←
No load maximum speed	3,190±50	←
Engine compression		
Standard value	35/250 (498/250)	←
Limit	28/250 (398/250)	←
Tire air pressure		
Front wheels	3.5(50)	←
Rear wheels	3.5(50)	←
Oil control valve set pressure		
Main relief	147~156 (2090~2218)	←
Part relief		107~114 (1522~1621)
Hub nut tightening torque	12~15 (87~108)	←
Battery fluid specific gravity (20°C)	1,280	←

### Lubricant capacities and types

Location		Model		4SDK3	4SDK4
Engine	Type	STD	Diesel engine oil API classification over CC SAE 10W-30	←	←
		OPT (*Cold area)	Diesel engine oil API classification over CC SAE 5W-30	←	←
	Capacity		3.0 ℓ (0.79 US gal)	2.7 ℓ (0.71 US gal)	
Oil tank	Type	STD OPT (*Cold area)	Auto fluid (ATF type F)	←	←
	Capacity		13 ℓ (3.43 US gal)	←	←
	Reduction device	STD OPT (*Cold area)	Diesel engine oil API classification over CC SAE 10W-30		
Lubrication points	Capacity	RH	8.0 ℓ (2.11 US gal)	←	←
		LH	10.0 ℓ (2.64 US gal)	←	←
	Type		Multipurpose grease	←	←
Fuel tank	Capacity		Proper amount	←	←
	Type		Diesel	←	←
	Capacity		25 ℓ (6.6 US gal)	←	←
Engine cooling system	Type	STD	Longlife coolant 30%	←	←
		OPT (*Cold area)	Longlife coolant 50%	←	←
	Capacity		3.2 ℓ (0.84 US gal)	3.4 ℓ (0.90 US gal)	

\* When using at temperatures of -20°C ~ -25°C

# LUBRICATION CHART

1. Multipurpose grease
2. Diesel engine oil
3. Diesel engine oil
4. Auto fluid

- I. 8-hour (daily) inspection
- II. 40-hour (weekly) inspection
- III. 170-hour (monthly) inspection
- IV. 500-hour (3-month) inspection
- V. 1000-hour (6-month) inspection

○ : Inspect  
 ● : Replace

- (1) Arm and cylinder each portion joint pin
- (2) Engine crank case
- (3) Hydraulic oil tank
- (4) Reduction device unit

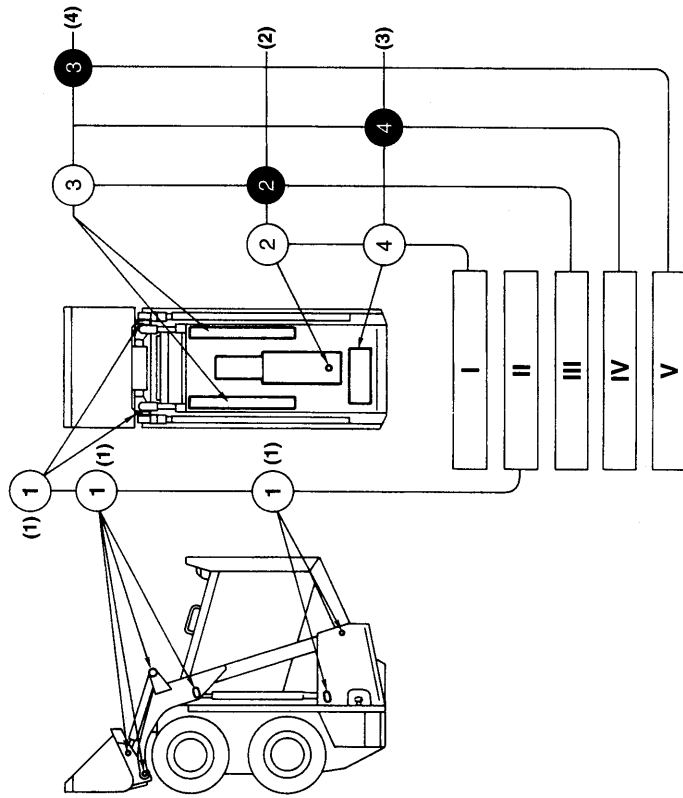

## FRAME SERIAL NUMBER

### Frame serial number location

The frame number is on the top of the inner frame of the engine room.

When you notify Toyota industrial Vehicle service shop of your vehicle abnormality, always inform them of the FRAME NUMBER.

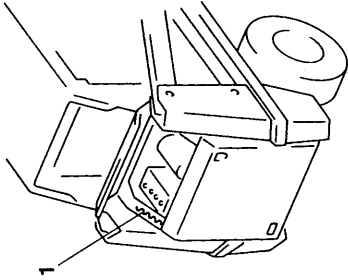

## RECOMMENDED LUBRICANTS

Refer to the attached table.

### 1. Frame serial number location

Vehicle model	Serial number
4SDK3	4SDK3-10011
4SDK4	4SDK4-10011

## VEHICLE DIMENSIONS

Refer to the attached table.

# VEHICLE DIMENSION

4SDK3

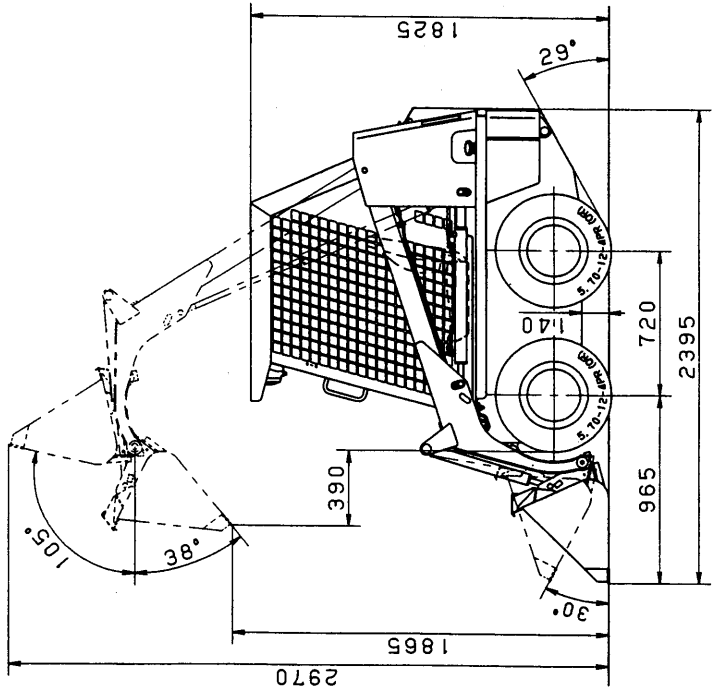
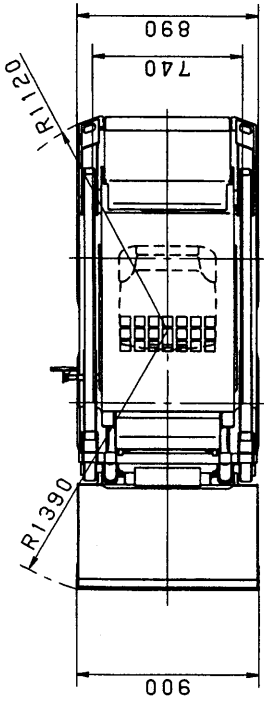

4SDK4

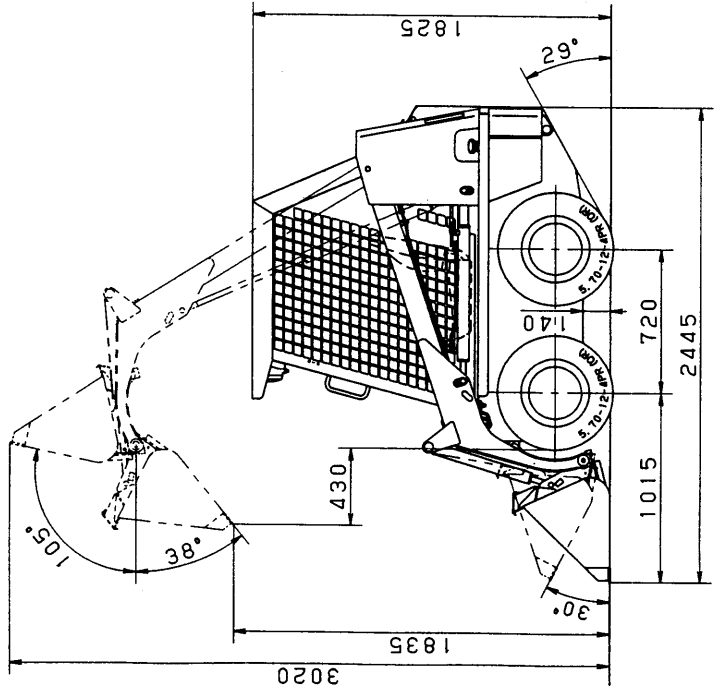
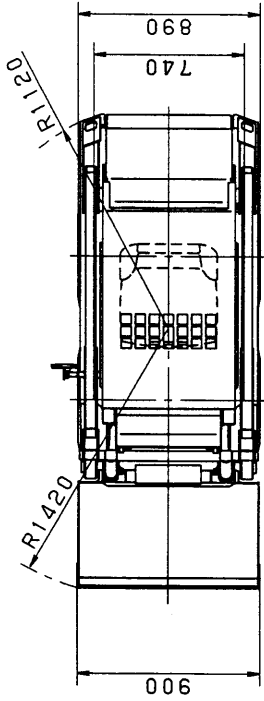

# RECOMMENDED LUBRICANTS FOR TOYOTA INDUSTRIAL TRUCKS

ENGINE GASOLINE (API SD, SE)	AGIP	BP	CALTEX	CASTROL	CHEVRON	ELF	ESSO	MOBIL	SHELL	SUN	TEXACO	TOTAL	VALVOLINE	VEEDEL
	SINT 2000 F-1 Super motor oil Motor Oil HD	BP Super Viacomatic BP Visco 2000 BP Energol HD	CX Motor Oil Supreme Five Star Motor Oil RPM DELO 400 RPM DELO 200 Oil	Castrol RX Super Castrol CRX	Chevron Custom Chevron Special Chevron Delo 400 Chevron Delo 200	ELF Prestige ELF Anti-Uaure ELF Prestita	Eso Extra Uniflo	Mobil 1 Mobil Super Mobil Special	SHELL Super SHELL Super Plus SHELL X-100 Five & Ice	Sunoco Special Sunoco Dynalube Sunlube	Havoline Supreme Havoline Super Havoline Multi-Grade Vrsatex	TOTAL GTS PLUS TOTAL Allgrade GT TOTAL Rubia H	XLD All-Climate HD	Veedel Diesel Star Veedel Diesel HDB
DIESEL (API CC, CD)	Superdiesel Diesel Sigma S Diesel Gamma	BP Vanellus M BP Vanellus C-3	RPM DELO 400 Oil RPM DELO 300 Oil RPM DELO 200 Oil RPM DELO 100 Oil	Castrol RX Super Castrol CRX Castrol CRD Castrol CRB	Chevron Delo 400 Chevron Delo 300 Chevron Delo 200 Chevron Delo 100	ELF Performance 28 ELF Performance 30 Performance HP	Esoilube HDX Esoilube D-3 Performance HP	Delvac Super Delvac Special Delvac 1200 Delvac 1300	Myrina Rimula Rotella	Sunfleet Dieselube Sunfleet MIL-B	Ursa Super Plus Ursa Oil Super 3 Ursa Extra Duty Ursatex	TOTAL Rubia H TOTAL Rubia S TOTAL Rubia X TOTAL Rubia TM	HD Super HPO All-Fleet (S-3)	Veedel Diesel Star Veedel Diesel HDB Veedel Diesel HD Veedel HDI
HYDRAULIC SYSTEM		BP Autoran G	Texematic Type F	Castrol TOF Castrol TO	Chevron Automatic Transmission Fluid Chevron ATF Special	Elf matic G2	Glide	ATF220	SHELL Donax TF	Sunoco Trans Fluid-Ford	Texematic Fluid Type F	TOTAL ATF33	Type FA	Veedel ATF Special Veedel ATF
REDUCTION GEAR UNIT	Superdiesel Diesel Sigma S Diesel Gamma	BP Vanellus M BP Vanellus C-3	RPM DELO 400 Oil RPM DELO 300 Oil RPM DELO 200 Oil RPM DELO 100 Oil	Deusol RX Super Deusol CRX Deusol CRD Deusol CRB	Chevron Delo 400 Chevron Delo 300 Chevron Delo 200 Chevron Delo 100	ELF Performance 28 ELF Performance 30 Performance HP	Esoilube HDX Esoilube D-3 Performance HP	Delvac Super Delvac Special Delvac 1200 Delvac 1300	Myrina Rimula Rotella	Sunfleet Dieselube Sunfleet MIL-B	Ursa Super Plus Ursa Oil Super 3 Ursa Oil Extra Duty Ursatex	TOTAL Rubia H TOTAL Rubia S TOTAL Rubia X TOTAL Rubia TM	HD Super HPO All-Fleet (S-3)	Veedel Diesel Star Veedel Diesel HDB Veedel Diesel HD Veedel HDI
ARM PIN SECTION	AGIP Grease 30	BP Energol L-2	Marfak All Purpose 2 RPM Multigrade Grease 2 Marfak Multipurpose 2	Castrol LM Grease	Chevron Multigrade Grease 2	ELF Multi ELF TU2	Eso Multipurpose Grease H	Mobilgrease MP Mobilgrease 532 523 Mobilgrease MS	SHELL Retimax A	Sunfleet HP Grease	Marfak All Purpose Marfak Multipurpose 2	TOTAL Multis 2	Multi-Lube Lithium EP Grease	Veedel Multipurpose or All Purpose Grease
COOLING SYSTEM	AGIP Antifreeze (LLC)	BP Antifreeze (LLC) BP Iscool (LLC)	AF Engine Coolant Multigrade 2	Castrol Antifreeze Castrol Long Life Coolant		Glacel	Eso Engine Coolant Eso Antifreeze	Mobil Permazane	SHELL LLC	Sunoco Multi-Season Antifreeze	Starflex AF and Summer Coolant	TOTAL Antifreeze TOTAL Coolant	Permanent Antifreeze Coolant	Veedel Antifreeze Veedel Long Life Coolant

LLC=Long Life Coolant



English

**TOYOTA MOTOR CORPORATION**  
Publication No. AE619 PRINTED IN JAPAN

096110-SZ