

MODELS | SJ 3215 SJ 3219



# Service Manual

SJIII Compact Series (CE)

Part No. 155147AD November 2013



**This manual is based on Serial Numbers:**

SJIII 3215 10,000,574 TO 10,000,630  
SJIII 3219 22,019,597 TO 22,022,792

Please refer to the website ([www.skyjack.com](http://www.skyjack.com)) for older Serial Numbers.

**Skyjack Service Center**

3451 Swenson Ave. St. Charles,  
Illinois, 60174 USA  
Phone: 630-262-0005  
Toll Free: 1-800-275-9522  
Fax: 630-262-0006  
Email: [service@skyjack.com](mailto:service@skyjack.com)

**Parts (North America)**

Toll Free: 1-800-965-4626  
Toll Free Fax: 1-888-782-4825  
E-mail: [parts@skyjack.com](mailto:parts@skyjack.com)

**Skyjack Australia Pty Ltd.**

4 Coates Place  
Wetherill Park  
New South Wales 2164  
Australia  
Tel: +61 (0) 28786 3200  
Fax: +61(0) 28786 3222

**Parts & Service (Europe)**

Unit 1 Maes Y Clawdd  
Maesbury Road Industrial Estate  
Oswestry, Shropshire SY10 8NN UK  
Phone: +44-1691-676-235  
Fax: +44-1691-676-238  
E-mail: [info@skyjackeurope.co.uk](mailto:info@skyjackeurope.co.uk)

**Skyjack Brasil**

Alameda Júpter, 710  
Loteamento American Park Empresarial  
Indaiatuba, SP, Brasil 13347-653  
Tel: +55 19 3936 0132

---

# DC Electric Scissor Lifts Service Manual

## Table of Contents

### **Section 1 - Scheduled Maintenance Inspections**

[Table of Contents](#)

### **Section 2 - Maintenance Tables**

[Table of Contents](#)

### **Section 3 - Schematics**

[Table of Contents](#)

### **Section 4 - Troubleshooting**

[Table of Contents](#)

### **Section 5 - Procedures**

[Table of Contents](#)

The Safety Alert Symbol identifies important safety messages on aerial platforms, safety signs in manuals or elsewhere. When you see this symbol, be alert to the possibility of personal injury or death. Follow the instructions in the safety message.



**This Safety Alert Symbol means attention!**

**Become alert! Your safety is involved.**



### **DANGER**

**DANGER** indicates an imminently hazardous situation which, if not avoided, will result in death or serious injury.



### **WARNING**

**WARNING** indicates a potentially hazardous situation which, if not avoided, could result in death or serious injury.



### **CAUTION**

**CAUTION** indicates a potentially hazardous situation which, if not avoided, may result in minor or moderate injury. It may also be used to alert against unsafe practices.

### **IMPORTANT**

**IMPORTANT** indicates a procedure essential for safe operation and which, if not followed, may result in a malfunction or damage to the aerial platform.

**Section 1**  
**SCHEDULE MAINTENANCE INSPECTIONS**

**Table of Contents**

**Operator’s Responsibility for Maintenance**

Aerial Platform Definition.....7

Purpose of Equipment.....7

Use of Equipment.....7

Manuals.....7

Service Policy and Warranty.....7

Optional Accessories.....7

Operator Safety Reminders.....8

Electrocution Hazard.....8

Safety Precautions.....9

Maintenance and Inspection Schedule.....12

Owner’s Annual Inspection Record.....12

Replacement Parts.....12

Maintenance and Service Safety Tips.....12

Hydraulic System & Component Maintenance and Repair.....13

Maintenance Hints.....13

**Service and Maintenance**

About this Section.....15

Service Bulletins.....15

Maintenance and Inspection.....15

Maintenance Instructions.....15

**Scheduled Maintenance**

1.1 Scheduled Maintenance Inspections.....18

1.2 Function Tests.....25

**Tables**

1.1 Owner’s Annual Inspection Record.....16

1.2 Maintenance and Inspection Checklist.....17

**SKYJACK** is continuously improving and expanding product features on its equipment, therefore, specifications and dimensions are subject to change without notice.

### Aerial Platform Definition

A mobile device that has a positionable platform supported from ground level by a structure.

### Purpose of Equipment

The SKYJACK SJIII Compact and Conventional series aerial platforms are designed to transport and raise personnel, tools and materials to overhead work areas.

### Use of Equipment

The aerial platform is a highly maneuverable, mobile work station. Lifting and driving must be on a flat, level, compacted surface.

### Manuals

#### Operating

The operating manual is considered a fundamental part of the aerial platform. It is a very important way to communicate necessary safety information to users and operators. A complete and legible copy of this manual must be kept in the provided weather-resistant storage compartment on the aerial platform at all times.

#### Service & Maintenance

The purpose of this is to provide the customer with the servicing and maintenance procedures essential for the promotion of proper machine operation for its intended purpose.

All information in this manual should be read and understood before any attempt is made to service the machine. The updated copy of the manuals are found on the company's website: [www.skyjack.com](http://www.skyjack.com).

### Service Policy and Warranty

SKYJACK warrants each new SJIII Series work platform to be free of defective parts and workmanship for the first 24 months. Any defective part will be replaced or repaired by your local SKYJACK dealer at no charge for parts or labor. Contact the SKYJACK Service Department for warranty statement extensions or exclusions.

### Optional Accessories

The SKYJACK aerial platform is designed to accept a variety of optional accessories. These are listed under "Standard and Optional Features" in [Table 2.1](#) of the Operating Manual. Operating instructions for these options (if equipped) are located in [section 2](#) of the operating manual.

For options not listed under "Standard and Optional Features," contact the SKYJACK Service Department at

 : 44-1691-676-235

 : 44-1691-676-238

Include the model and serial number for each applicable aerial platform.

### Scope of this Manual

- a. This manual applies to the CE version of the SJIII Series aerial platform models listed on [Table 2.1](#).

Equipment identified with "CE" meets the requirements for the European countries, i.e., Machinery Directive 2006/42/EC and Directive 2004/108/EC and the corresponding EN standards.

- b. Operators are required to conform to national, state or territorial/provincial and local health and safety regulations applicable to the operation of this aerial platform.

**WARNING**

**Failure to comply with your required responsibilities in the use and operation of the aerial platform could result in death or serious injury!**

**Operator Safety Reminders**

A study conducted by St. Paul Travelers showed that most accidents are caused by the failure of the operator to follow simple and fundamental safety rules and precautions.

You, as a careful operator, are the best insurance against an accident. Therefore, proper usage of this aerial platform is mandatory. The following pages of this manual should be read and understood completely before operating the aerial platform.

Common sense dictates the use of protective clothing when working on or near machinery. Use appropriate safety devices to protect your eyes, ears, hands, feet and body.

Any modifications from the original design are strictly forbidden without written permission from SKYJACK.

**Electrocution Hazard**

This aerial platform is not electrically insulated. Maintain a Minimum Safe Approach Distance (MSAD) from energized power lines and parts as listed below. The operator must allow for the platform to sway, rock or sag. This aerial platform does not provide protection from contact with or proximity to an electrically charged conductor.

**DO NOT USE AERIAL PLATFORM AS A GROUND FOR WELDING.  
DO NOT OPERATE AERIAL PLATFORM DURING LIGHTNING OR STORMS.**

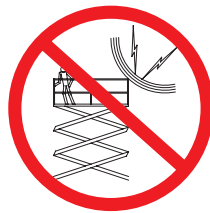
**DANGER**

**Avoid Power Lines**

**Minimum Safe Approach Distance**

**CE Guidance Note**

“Avoidance of danger from overhead lines”

**Adhere strictly to the governmental rulings and regulations applicable in your country.**

**FAILURE TO AVOID THIS HAZARD WILL RESULT IN DEATH OR SERIOUS INJURY!**

60023AE-CE

**Safety Precautions**

Know and understand the safety precautions before going on to next section.



**WARNING**

Failure to heed the following safety precautions could result in tip over, falling, crushing, or other hazards leading to death or serious injury.

- **KNOW** all national, state or territorial/provincial and local rules which apply to your aerial platform and jobsite.
- **TURN** main power disconnect switch “○” off when leaving the aerial platform unattended. Remove the key to prevent unauthorized use of the aerial platform.
- **WEAR** all the protective clothing and personal safety devices issued to you or called for by job conditions.

- **DO NOT** wear loose clothing, dangling neckties, scarves, rings, wristwatches or other jewelry while operating this lift.

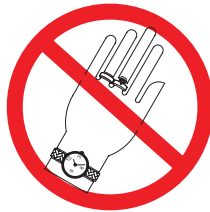

- **AVOID** entanglement with ropes, cords or hoses.



- **AVOID** falling. Stay within the boundaries of the guardrails.



- **DO NOT** raise the aerial platform in windy or gusty conditions.

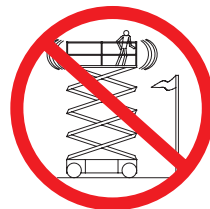

- **DO NOT** increase the lateral surface area of the platform. Increasing the area exposed to the wind will decrease aerial platform stability.



- **DO NOT** drive or elevate the aerial platform if it is not on a firm level surface. Do not drive elevated near depressions or holes of any type, loading docks, debris, drop-offs and surfaces that may affect the stability of the aerial platform.



- **If operation in areas with holes or drop-offs is absolutely necessary**, elevated driving shall not be allowed. Position the aerial platform horizontally only with the platform fully lowered. After ensuring that all 4 wheels or outriggers (if equipped) have contact with level firm surface, the aerial platform can be elevated. After elevation, the drive function must not be activated.



- **Elevated driving** must only be done on a firm level surface.



- **DO NOT** ascend or descend a grade when elevated. When fully lowered, ascending or descending only grades up to rated maximum listed in [Table 2-3](#) are permissible.





**Safety Precautions (Continued)**

Know and understand the safety precautions before going on to next section.

- **DO NOT** operate on surfaces not capable of holding the weight of the aerial platform including the rated load, e.g. covers, drains, and trenches.

- **DO NOT** operate an aerial platform that has ladders, scaffolding or other devices mounted on it to increase its size or work height. It is prohibited.



- **DO NOT** exert side forces on aerial platform while elevated.



- **DO NOT** use the aerial platform as a crane. It is prohibited.



- **DO NOT** sit, stand or climb on the guardrails. It is prohibited.



- **DO NOT** climb on scissor arm assembly. It is prohibited.



- **BE AWARE** of overhead obstructions or other possible hazards around the aerial platform when driving or lifting.

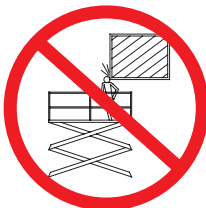

- **DO NOT** raise the aerial platform while the aerial platform is on a truck, fork lift or other device or vehicle.



- **BE AWARE** of crushing hazards. Keep all body parts inside platform guardrail.



- **DO NOT** lower the platform unless the area below is clear of personnel and obstructions.



- **ENSURE** that there are no personnel or obstructions in the path of travel, including blind spots.

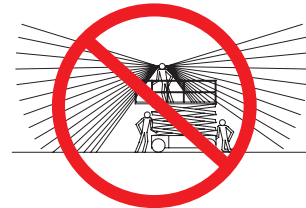

- **BE AWARE** of blind spots when operating the aerial platform.

- **STUNT** driving and horseplay are prohibited.

- **ENSURE ALL** tires are in good condition and lug nuts are properly tightened.

- **DO NOT** alter or disable limit switches or other safety devices.

- **DO NOT** use the aerial platform without guardrails, locking pins and the entry gate in place.

### Safety Precautions (Continued)

Know and understand the safety precautions before going on to next section.

- **DO NOT** exceed the rated capacity of the aerial platform. Do make sure the load is evenly distributed on the platform.
- **DO NOT** attempt to free a snagged platform with lower controls until personnel are removed from the platform.
- **DO NOT** position the aerial platform against another object to steady the platform.
- **DO NOT** place materials on the guardrails or materials that exceed the confines of the guardrails unless approved by Skyjack.



#### **WARNING**

**Entering and exiting the aerial platform should only be done using the three points of contact.**

- Use only equipped access openings.
- Enter and exit only when the aerial platform is in the fully retracted position.
- Do use three points of contact to enter and exit the platform. Enter and exit the platform from the ground only. Face the aerial platform when entering or exiting the platform.
- Three points of contact means that two hands and one foot or one hand and two feet are in contact with the aerial platform or the ground at all times during entering and exiting.



#### **WARNING**

**An operator should not use any aerial platform that:**

- does not appear to be working properly.
- has been damaged or appears to have worn or missing parts.
- has alterations or modifications not approved by the manufacturer.
- has safety devices which have been altered or disabled.
- has been tagged or blocked out for non-use or repair.

**Failure to avoid these hazards could result in death or serious injury.**

#### **Jobsite Inspection**

- Do not use in hazardous locations.
- Perform a thorough jobsite inspection prior to operating the aerial platform, to identify potential hazards in your work area.
- Be aware of moving equipment in the area. Take appropriate actions to avoid collision.

### Maintenance and Inspection Schedule

The actual operating environment of the work platform governs the use of the maintenance schedule. The inspection points covered in [Table 1.2](#). Maintenance and Inspection Checklist, indicates the areas of the aerial platform to be maintained or inspected and at what intervals the maintenance and inspections are to be performed.

### Owner's Annual Inspection Record

It is the responsibility of the owner to arrange quarterly and annual inspections of the aerial platform. [Table 1.1](#). Owner's Annual Inspection Record is to be used for recording the date of the inspection, owner's name, and the person responsible for the inspection of the work platform.

### Replacement Parts

Use only original replacement parts. Parts such as batteries, wheels, railings, etc. with weight and dimensions different from original parts will affect stability of the aerial platform and must not be used without manufacturer's consent.

All replacement tires must be of the same size and load rating as originally supplied tires; to maintain safety and stability of aerial platform.

Consult SKYJACK's Service Department for optional tires specifications and installation.



### **WARNING**

**Any unit that is damaged or not operating properly must be immediately tagged and removed from service until proper repairs are completed.**

### Maintenance and Service Safety Tips

Maintenance and repair should only be performed by personnel who are trained and qualified to service this aerial platform.

All maintenance and service procedures should be performed in a well lighted and well ventilated area.

Anyone operating or servicing this aerial platform must read and completely understand all operating instructions and safety hazards in this manual and operating manual.

All tools, supports and lifting equipment to be used must be of proper rated load and in good working order before any service work begins. Work area should be kept clean and free of debris to avoid contaminating components while servicing.

All service personnel must be familiar with employer and governmental regulations that apply to servicing this type of equipment.

Keep sparks and flames away from all flammable or combustible materials.

Properly dispose of all waste material such as lubricants, rags, and old parts according to the relative law provisions obtaining in the country.

Before attempting any repair work, turn Battery Disconnect Switch to the "OFF" position.

Preventive maintenance is the easiest and least expensive type of maintenance.

### Hydraulic System & Component Maintenance and Repair

The following points should be kept in mind when working on the hydraulic system or any component:

1. Any structure has limits of strength and durability. To prevent failure of structural parts of hydraulic components, relief valves which limit pressure to safe operating values are included in the hydraulic circuits.
2. Tolerance of working parts in the hydraulic system is very close. Even small amounts of dirt or foreign materials in the system can cause wear or damage to components, as well as general faulty operation of the hydraulic system. Every precaution must be taken to assure absolute cleanliness of the hydraulic oil.
3. Whenever there is a hydraulic system failure which gives reason to believe that there are metal particles or foreign materials in the system, drain and flush the entire system and replace the filter cartridges. A complete change of oil must be made under these circumstances.
4. Whenever the hydraulic system is drained, check the magnets in the hydraulic reservoir for metal particles. If metal particles are present, flush the entire system and add a new change of oil. The presence of metal particles also may indicate the possibility of imminent component failure. A very small amount of fine particles is normal.
5. All containers and funnels used in handling hydraulic oil must be absolutely clean. Use a funnel when necessary for filling the hydraulic oil reservoir, and fill the reservoir only through the filter opening. The use of cloth to strain the oil should be avoided to prevent lint from getting into the system.
6. When removing any hydraulic component, be sure to cap and tag all hydraulic lines involved. Also, plug the ports of the removed components.

#### NOTE

Samples of hydraulic oil should be drawn from the reservoir and tested annually. These samples should be taken when the oil is warmed through normal operation of the system. The sample should be analyzed by a qualified lubrication specialist to determine if it is suitable for continued use.

Oil change intervals will depend on the care used in keeping the oil clean, and the operating conditions. Dirt and/or moisture contamination will dictate that the oil should be changed more often. Under normal use and operating conditions, the hydraulic oil should be changed every two years. Refer to [Table 1.2](#) of this manual.

7. All hydraulic components must be dis-assembled in spotlessly clean surroundings. During disassembly, pay particular attention to the identification of parts to assure proper reassembly. Clean all metal parts in a clean mineral oil solvent. Be sure to thoroughly clean all internal passages. After the parts have been dried thoroughly, lay them on a clean, lint-free surface for inspection.
8. Replace all O-rings and seals when overhauling any component. Lubricate all parts with clean hydraulic oil before reassembly. Use small amounts of petroleum jelly to hold O-rings in place during assembly.
9. Be sure to replace any lost hydraulic oil when completing the installation of the repaired component, and bleed any air from the system when required.
10. All hydraulic connections must be kept tight. A loose connection in a pressure line will permit the oil to leak out or air to be drawn into the system. Air in the system can cause damage to the components and noisy or erratic system operation.

#### Maintenance Hints

Three simple maintenance procedures have the greatest effect on the hydraulic system performance, efficiency and life. Yet, the very simplicity of them may be the reason they are so often overlooked. What are they? Simply these:

1. Change filters annually. The filters will need to be changed more often depending on the operating conditions. Dirty, dusty, high moisture environments may cause the hydraulic system to be contaminated more quickly.
2. Maintain a sufficient quantity of clean hydraulic oil of the proper type and viscosity in the hydraulic reservoir.
3. Keep all connections tight.

**About this Section**

This section contains the maintenance and inspection schedule that is to be performed.

References are made to the procedures in Section 5 that outline detailed step-by-step instructions for checks and replacements.

**Service Bulletins**

Before performing any scheduled maintenance inspection procedure, refer to service bulletins found in our web site: [www.skyjackinc.com](http://www.skyjackinc.com) for updates related to service and maintenance of this aerial platform.

**Maintenance and Inspection**

Death or injury can result if the aerial platform is not kept in good working order. Inspection and maintenance should be performed by competent personnel who are trained and qualified on maintenance of this aerial platform.

**WARNING**

**Failure to perform each procedure as presented and scheduled may cause death, serious injury or substantial damage.**

**NOTE**

Preventive maintenance is the easiest and least expensive type of maintenance.

- Unless otherwise specified, perform each maintenance procedure with the aerial platform in the following configuration:
  - Aerial platform parked on a flat and level surface
  - Disconnect the battery by turning the main power disconnect switch to the "OFF" position.
- Repair any damaged or malfunction components before operating aerial platform.
- Keep records on all inspections.

**Maintenance Instructions**

This manual consists of four schedules to be done for maintaining on an aerial platform. Inspection schedule frequency is shown below:

**Inspection Schedule**

Daily	A
Frequently	A + B
Annually	A + B + C
Bi-annually	A + B + C + D

- Make copies of the maintenance and inspection checklist to be used for each inspection.
- Check the schedule on the checklist for the type of inspection to be performed.
- Place a check in the appropriate box after each inspection procedure is completed.
- Use the maintenance and inspection checklist and step-by-step procedures in Section 5 to perform these inspections.
- If any inspection receives a fail, tag and remove the aerial platform from service.
- If any aerial platform component(s) has been repaired, an inspection must be performed again before removing the tag. Place a check in the repair column.

**Legend**

P = Pass  
F = Fail  
R = Repaired

Table 1.1 Owner’s Annual Inspection Record

<b>Model Number:</b> _____		<b>Serial Number:</b> _____								
Inspection Date										
Recording Year	New	<b>1</b>	<b>2</b>	<b>3</b>	<b>4</b>	<b>5</b>	<b>6</b>	<b>7</b>	<b>8</b>	<b>9</b>
Owner’s Name	Skyjack Inc.									
Inspected By	Skyjack Inc.									

158AA

As described earlier in this section, this decal is located on the scissor assembly. It must be completed after an annual inspection has been completed. Do not use the aerial platform if an inspection has not been recorded in the last 6 months.



Table 1.2 MAINTENANCE AND INSPECTION CHECKLIST

Serial Number: \_\_\_\_\_  
 Model: \_\_\_\_\_  
 Hourmeter Reading: \_\_\_\_\_  
 Date: \_\_\_\_\_  
 Time: \_\_\_\_\_

Name (Printed): \_\_\_\_\_  
 Signature: \_\_\_\_\_

Each item shall be inspected using the the appropriate section of the Skyjack operating manual.  
 As each item is inspected, write the appropriate grade in the box.

- INSPECTION FREQUENCY**
- DAILY
  - FREQUENTLY
  - ANNUALLY
  - BI-ANNUALLY
- P** - PASS  
**F** - FAIL  
**R** - REPAIRED

Inspection Schedule	
Daily	A
Frequently*†	A + B
Annually†	A + B + C
Bi-annually†	A + B + C + D

Schedule	P	F	R
<b>Schedule Maintenance Inspections</b>			
Labels	A		
Limit Switches	A, B		
<b>Entrance Side</b>			
Main Power Disconnect Switch	A, B		
Base Control Switches	A, B		
Free-wheeling Valve Knob (Compacts - Front Side)	A, B		
Brakes	A, B, C		
AC Outlet Receptacle	A, B		
Ladder	A, B		
<b>Battery Tray Side</b>			
Pothole Protection Device	A, B		
Battery Tray	A, B		
Battery Charger	A, B		
Battery	A, B		
Steer Cylinder Assembly	A, B		
Wheel/Tire Assembly	A, B		
Tie Rod (Conventionals)	A, B		
Greasing Points	A, B, C		
<b>Hydraulic/Electric Tray Side</b>			
Pothole Protection Device	A, B		
Hydraulic Tank	A, B, C		
Hydraulic Oil	A, B, C		
Hydraulic Pump and Motor	A, B		
Electrical Panel	A, B		
Proportional and Main Manifolds	A, B		
Load/Tilt Sensor	A, B		
Emergency Lowering Access Rod (If Equipped)	A, B		

Schedule	P	F	R
<b>Platform Assembly</b>			
Lanyard Attachment Anchors	A, B		
AC Outlet on Platform	A, B		
Platform Control Console	A, B		
Manuals	A, B		
Powered Extension Control Console (If Equipped)	A, B		
<b>Lift Mechanism</b>			
Maintenance Support	A, B		
Scissor Assembly	A, B		
Scissor Bumpers	A, B		
Rollers	A, B		
Lift Cylinder(s)	A, B		
<b>Function Tests</b>			
Test Main Power Disconnect Switch	A, B		
<b>Base Control Console</b>			
Test Base Emergency Stop	A, B		
Test Off/Platform/Base	A, B		
Test Lower/Neutral/Raise Switch	A, B		
Test Emergency Lowering	A, B		
Test Free-wheeling	A, B		
<b>Platform Control Console</b>			
Test Platform Emergency Stop	A, B		
Test Enable Trigger Switch	A, B		
Test Steering	A, B		
Test Driving	A, B		
Test Brakes	A, B		
Test Platform Raising/Lowering	A, B		
Test Lowering Warning	A, B		
Test Horn	A, B		
Test Pothole Sensor	A, B		
Test Elevated Drive Speed	A, B		

1003AA

- A** - Perform Visual and Daily Maintenance Inspections & Functions Test. Refer to Section 2 of the Operating Manual.
- B** - Perform Scheduled Maintenance Inspection every three months or 150 hrs. Refer to Section 1 of this manual.
- C** - Perform Scheduled Maintenance Inspection every year. Refer to Section 1 of this manual.
- D** - Perform Scheduled Maintenance Inspection every 2 years. Refer to Section 1 of this manual.
- \* Perform scheduled inspection every three months or 150 hours.
- † - Refer to Skyjack's website @ [www.skyjack.com](http://www.skyjack.com) for latest service bulletins prior to performing quarterly or yearly inspection.

**Note:** Make a copy of this page or visit the Skyjack web site: [www.skyjack.com](http://www.skyjack.com) for a printable copy.

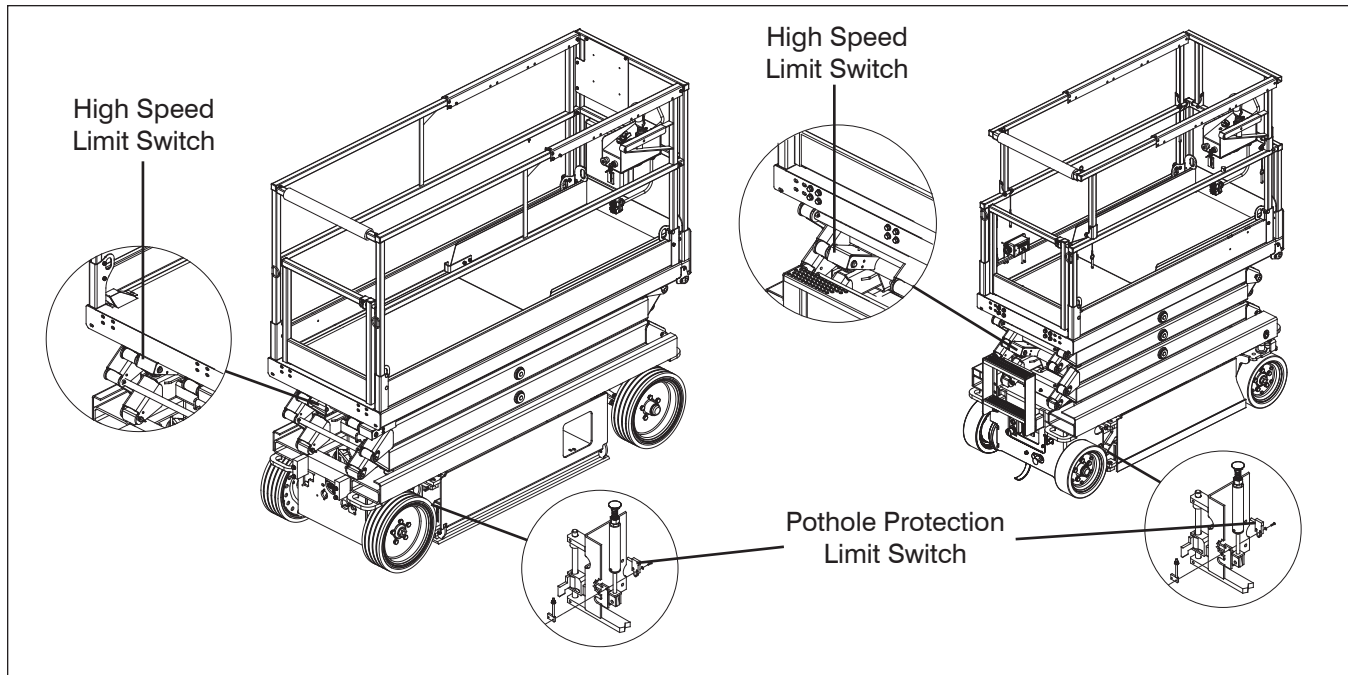

**1.1 Scheduled Maintenance Inspections**

Begin the scheduled maintenance inspections by checking each item in sequence for the conditions listed in this section.



**WARNING**

To avoid injury, do not operate an aerial platform until all malfunctions have been corrected.



**WARNING**

To avoid possible injury, ensure aerial platform power is off during your visual and daily maintenance inspections.

**Electrical**

Maintaining the electrical components is essential to good performance and service life of the aerial platform.

Inspect the following areas for chafed, corroded and loose wires:

- base to platform cables and wiring harness
- battery tray wiring harnesses
- hydraulic/electrical wiring harnesses

**Hydraulic**

Maintaining the hydraulic components is essential to good performance and service life of the aerial platform.

Perform a visual inspection around the following areas:

- hoses and fittings
- all hydraulic cylinders
- all hydraulic manifolds
- the underside of the base
- ground area under the aerial platform

**1.1-1 Labels**

Refer to the labels section in this manual and determine that all labels are in place and are legible.

**1.1-2 Limit Switches**

Detecting limit switch malfunction is essential to safe aerial platform operation. Ensure limit switches are properly secured and movement is not obstructed.

Visually inspect all limit switch located inside the scissor arms and the outrigger assemblies for the following:

- broken or missing actuator arm
- missing fasteners
- loose wiring



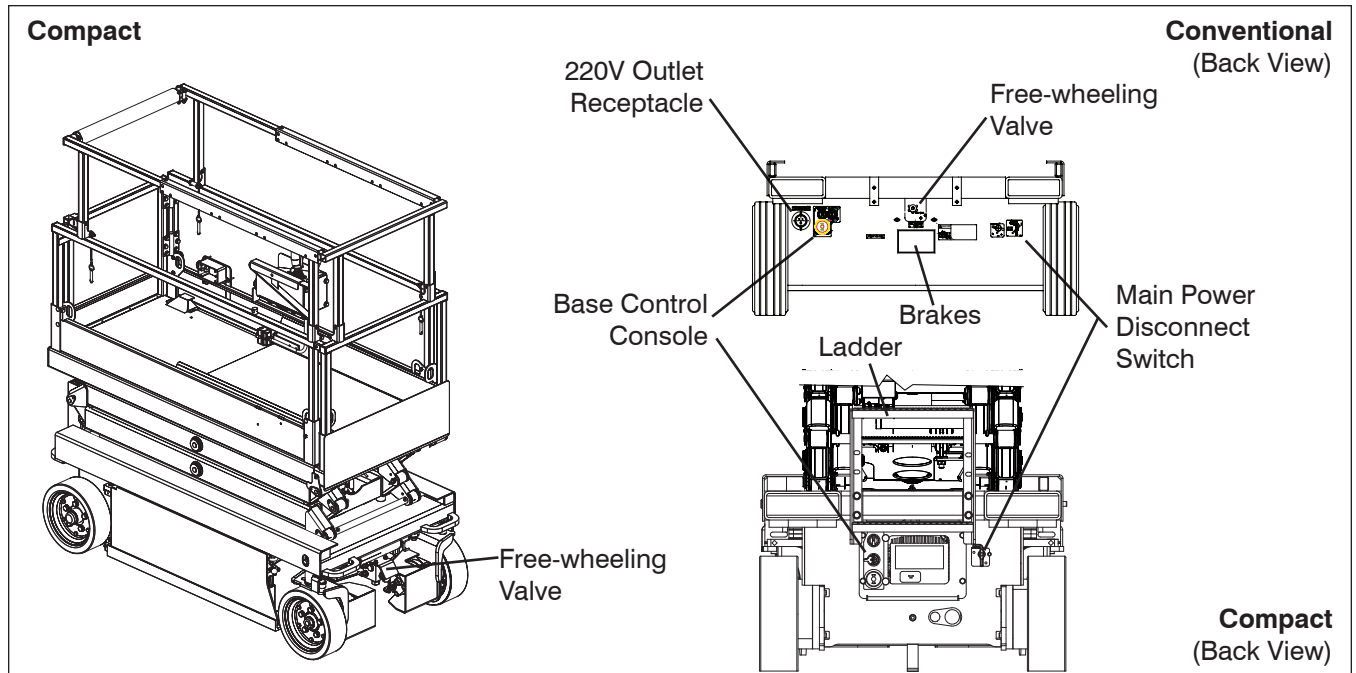

### 1.1-3 Entrance Side

- **Main Power Disconnect Switch**
  - Turn main power disconnect switch to “○” off position.
  - Ensure all cables are secure and switch is in proper working condition.
- **Base Control Switches**
  - Ensure there are no signs of visible damage and all switches are in their neutral positions.
- **Free-wheeling Valve Knob**  
(Compacts - Front Side)
  - Ensure there are no loose or missing parts and there is no visible damage.
- **Brakes**
  - Ensure there are no loose or missing parts and there is no visible damage.
- **AC Outlet Receptacle**
  - Ensure receptacle is free from dirt and obstructions.
- **Ladder**
  - Ensure there are no loose or missing parts and there is no visible damage.

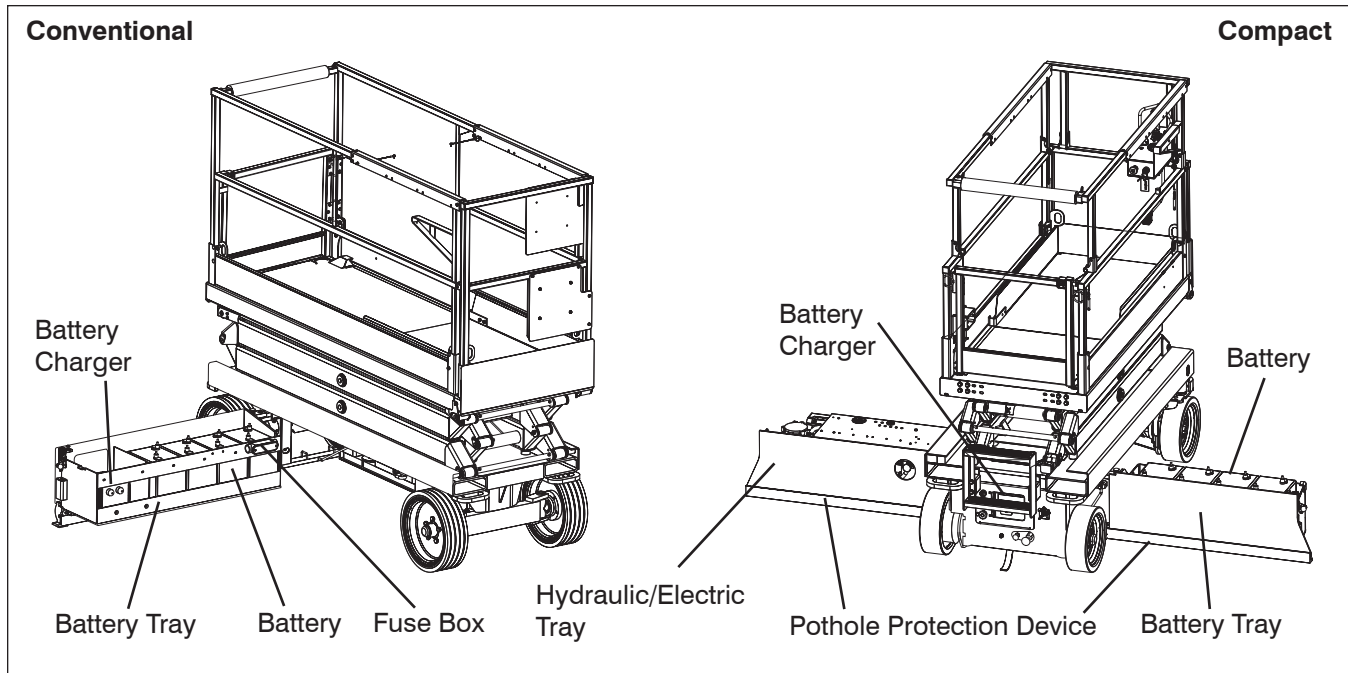

**1.1-4 Battery Tray Side**

- **Pothole Protection Device**
  - Ensure mechanisms have no sign of visible damage and are free from dirt and obstructions.
- **Battery Tray**
  - Ensure tray latch is secure and in proper working order.
- **Battery Charger**  
(Compacts - Entrance Side)
  - Ensure charger is secure and shows no visible damage.
- **Battery**  
Proper battery condition is essential to good performance and operational safety. Improper fluid levels or damaged cables and connections can result in component damage and hazardous conditions.

**! WARNING**

**Battery acid is extremely corrosive - Wear proper eye and facial protection as well as appropriate protective clothing. If contact occurs, immediately flush with cold water and seek medical attention.**

1. Check battery case for damage.
2. Clean battery terminals and cable ends thoroughly with a terminal cleaning tool or wire brush.
3. Ensure all battery connections are tight.
4. If applicable, check battery fluid level. If plates are not covered by at least 13 mm of solution, add distilled or demineralized water.
5. Replace battery if damaged or incapable of holding a lasting charge.



**WARNING**

**Explosion hazard. Keep flames and sparks away. Do not smoke near batteries.**



**WARNING**

**Use original or manufacturer-approved parts and components for the aerial platform.**

## Conventional

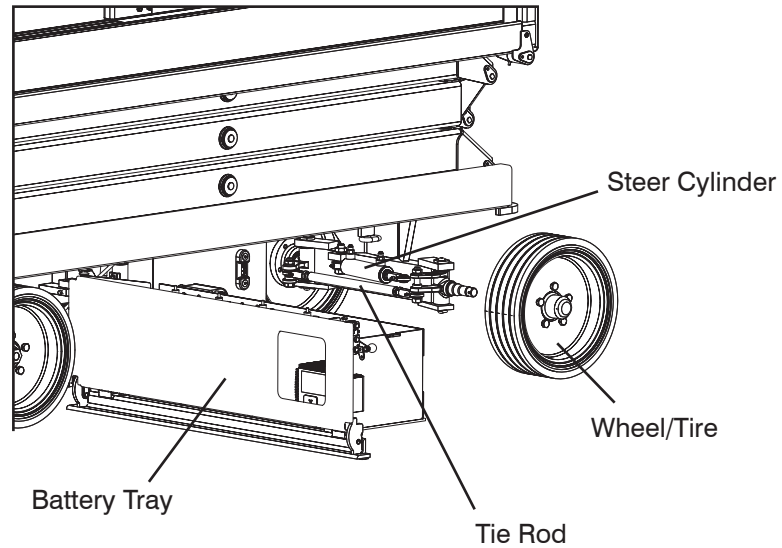

- **Steer Cylinder Assembly**
    - Ensure steer cylinder assembly is properly secured and there are no loose or missing parts.
  - **Wheel/Tire Assembly**

The aerial platform is either equipped with solid rubber tires or foam-filled tires. Tire and/or wheel failure could result in an aerial platform tip-over. Component damage may also result if problems are not discovered and repaired in a timely fashion.

    - Check all tire treads and sidewalls for cuts, cracks, punctures and unusual wear.
    - Check each wheel for damage and cracked welds.
    - Check each lug nut for proper torque to ensure none are loose.
    - Check wheel motor assembly for loose or missing parts and signs of visible damage.
    - Ensure wheels are aligned and true vertically and horizontally.
  - **Tie Rod (Conventionals)**
    - Ensure there are no loose or missing parts, tie rod end studs are locked and there is no visible damage.
  - **Greasing Points**
    - Ensure greasing points have no sign of visible damage and are free from dirt and obstructions.
- B - Frequent Inspection**
- Locate grease fittings and pump grease as needed.

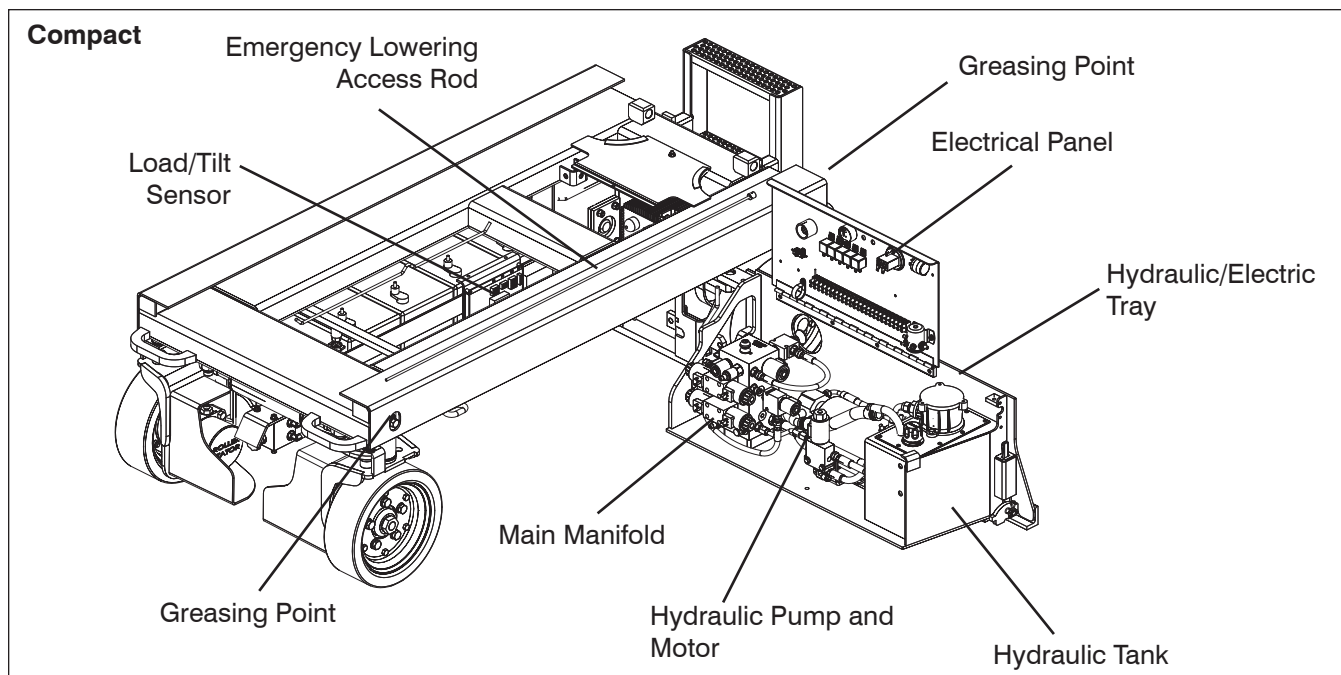

**1.1-5 Hydraulic/Electric Tray Side**

- Ensure tray latch is secure and in proper working order.
- **Pothole Protection Device**
  - Ensure mechanisms have no sign of visible damage and are free from dirt and obstructions.
- **Hydraulic Tank**
  - Ensure hydraulic filler cap is secure.
  - Ensure tank shows no visible damage and no evidence of hydraulic leakage.
- **Hydraulic Oil**
  - Ensure platform is fully lowered, and then visually inspect the sight gauge located on the side of the hydraulic oil tank.
  - The hydraulic oil level should be at or slightly above the top mark of the sight glass.

**C - Annual Inspection**

- [Refer to Section 1 - Hydraulic System & Component Maintenance and Repair.](#)
- **Hydraulic Pump and Motor**
  - Ensure there are no loose or missing parts and there is no visible damage.

- **Electrical Panel**
  - Ensure panel is properly secured and there is no visible damage.
  - Ensure there are no loose wires or missing fasteners.
- **Proportional and Main Manifolds**
  - Ensure all fittings and hoses are properly tightened and there is no evidence of hydraulic leakage.
  - Ensure there are no loose wires or missing fasteners.
- **Load/Tilt Sensor**
  - Ensure load/tilt sensor is properly secured and there is no visible damage.
- **Emergency Lowering Access Rod (If Equipped)**
  - Ensure rod is properly secured and there is no visible damage.

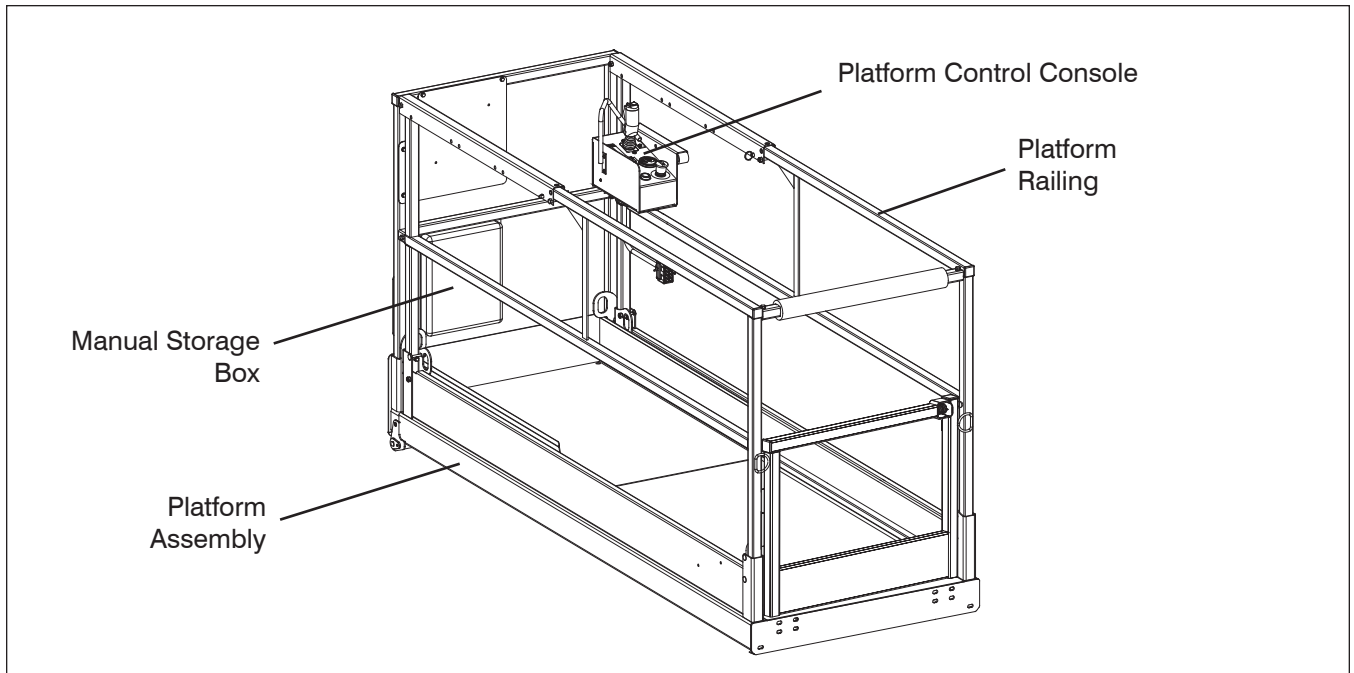

### 1.1-6 Platform Assembly



#### **WARNING**

**Ensure that you maintain three points of contact to mount/dismount platform.**

1. Use the ladder of aerial platform to access platform.
  2. Close the gate.
    - Ensure there are no loose or missing parts and there is no visible damage.
    - Ensure all fasteners are securely in place.
    - Ensure all railings are properly positioned and secured.
    - Ensure gate is in good working order.
- **Lanyard Attachment Anchors**
    - Ensure attachment rings are secure and no visible damage.
  - **AC Outlet on Platform**
    - Ensure outlet has no visible damage and free from dirt or obstructions.
  - **Platform Control Console**
    - Ensure all switches and controller are returned to neutral and are properly secured.
    - Ensure there are no loose or missing parts and there is no visible damage.
  - **Manuals**
    - Ensure a copy of operating manual and other important documents are enclosed in manual storage box.
    - Check to be sure manual storage box is present and in good condition.
    - Ensure manuals are legible and in good condition.
    - Always return manuals to the manual storage box after use.

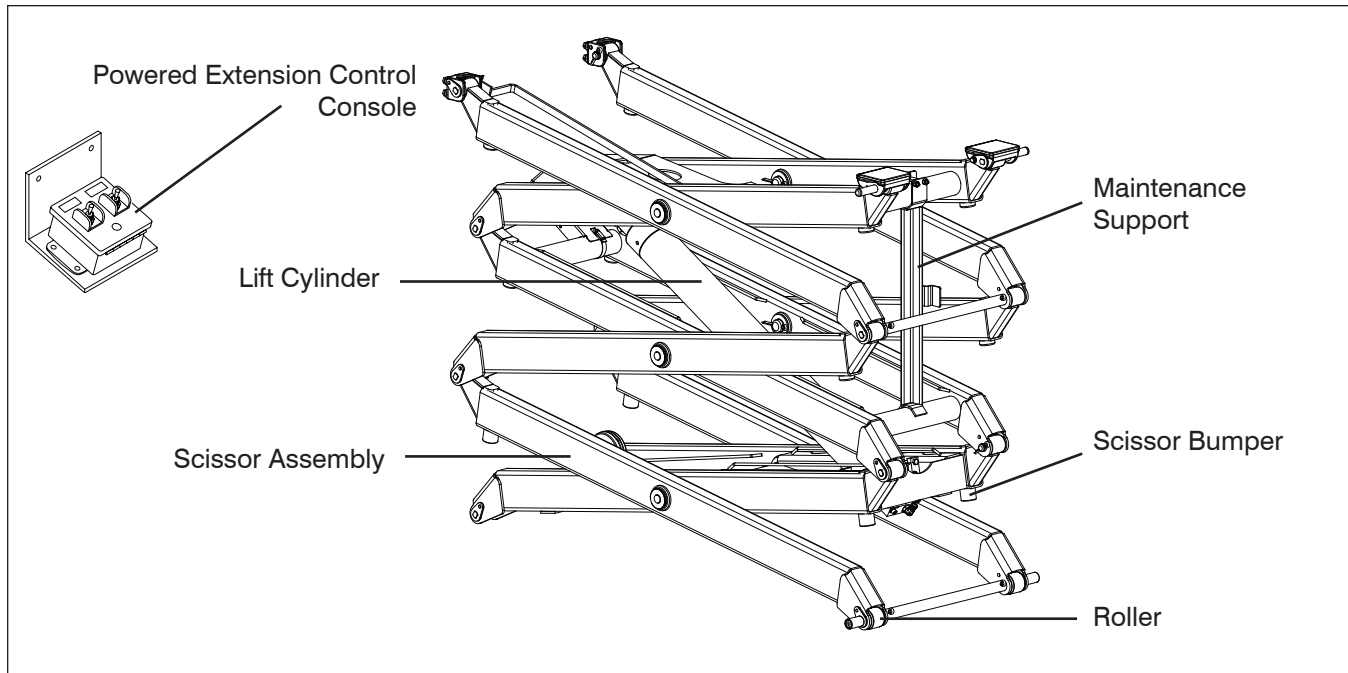

- **Powered Extension Control Console (If Equipped)**
  - Ensure all switches are returned to neutral and are properly secured.
  - Ensure there are no loose or missing parts and there is no visible damage.



**WARNING**

**Ensure that you maintain three points of contact to mount/dismount platform.**

- **Scissor Bumpers**
  - Ensure bumpers are secure and shows no sign of visible damage.
- **Rollers**
  - Ensure rollers are secure and there is no visible damage.
  - Ensure rollers' path of travel are free from dirt and obstructions.
- **Lift Cylinder(s)**
  - Ensure each lift cylinder is properly secured, there are no loose or missing parts and there is no evidence of damage.
  - Ensure all fittings and hoses are properly tightened and there is no evidence of hydraulic leakage.

3. Use the ladder to dismount from platform.

**1.1-7 Lifting Mechanism**

1. Raise the platform until there is adequate clearance to swing down the maintenance support.
  - **Maintenance Support**
    - Ensure maintenance support is properly secured and shows no visible damage.
  - **Scissor Assembly**
    - Ensure scissor assembly shows no visible damage and no signs of deformation in weldments.
    - Ensure all pins are properly secured.
    - Ensure cables and wires are properly routed and shows no signs of wear and/or physical damage.

2. Raise the platform until there is adequate clearance to swing up the maintenance support.
3. Swing up maintenance support into storage bracket.
4. Fully lower the platform.

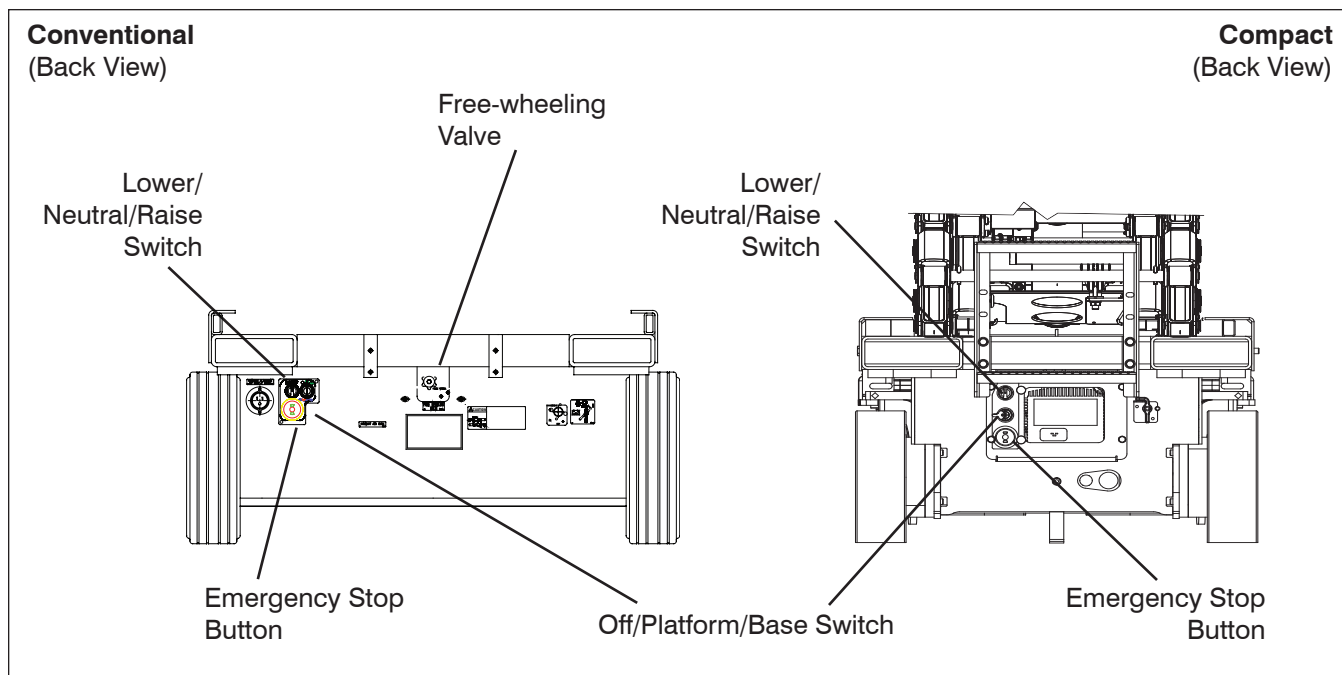

## 1.2 Function Tests

Function tests are designed to discover any malfunctions before aerial platform is put into service. The operator must understand and follow step-by-step instructions to test all aerial platform functions.



### **WARNING**

**Never use a malfunctioning aerial platform. If malfunctions are discovered, aerial platform must be tagged and placed out of service. Repairs to aerial platform may only be made by a qualified service technician.**

After repairs are completed, operator must perform a pre-operation inspection and a series of function tests again before putting aerial platform into service.

Prior to performing function tests, be sure to read and understand Section 2.10 - Start Operation of the operating manual.

### 1.2-1 Test Main Power Disconnect Switch

1. At rear of the base, turn main power disconnect switch to “○” off position.  
**Result:** Aerial platform functions should not operate.

### 1.2-2 Base Control Console





### **WARNING**

**Ensure that you maintain three points of contact when using the ladder to mount/dismount platform.**

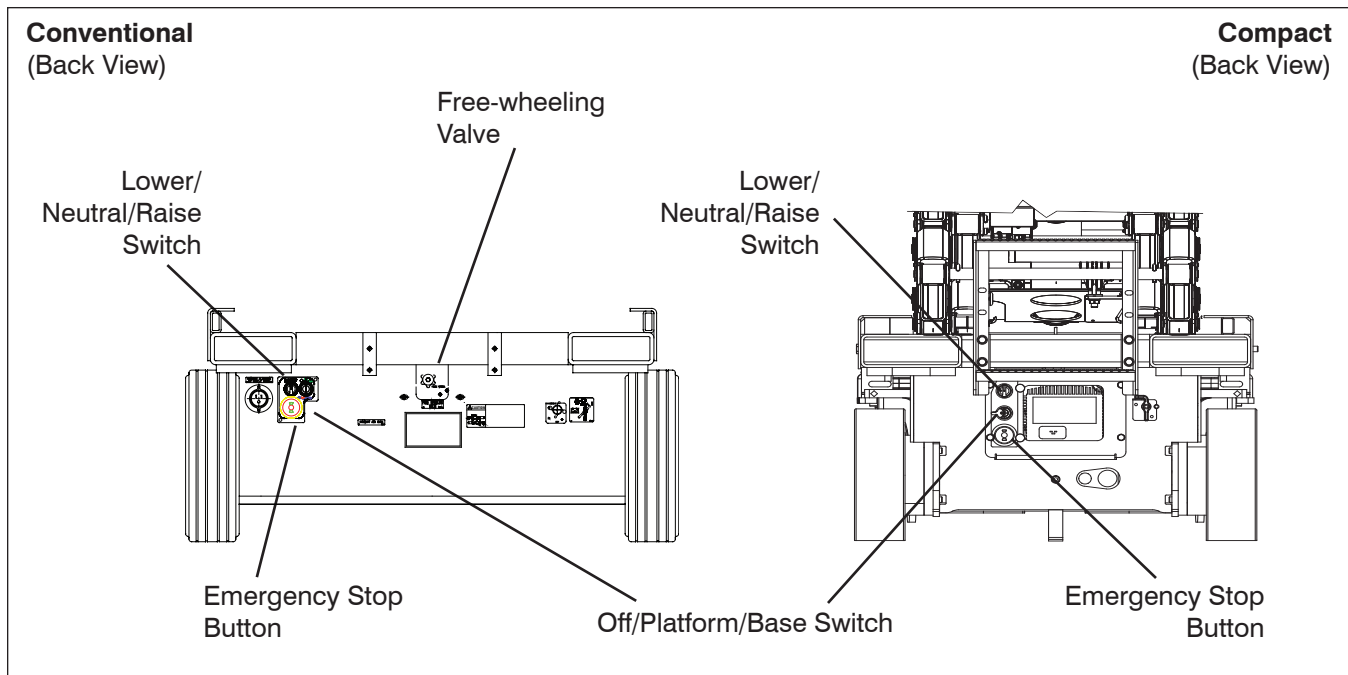
1. Use the ladder of aerial platform to access platform.
2. Close the gate.
3. On platform control console, pull out “●” emergency stop button.
4. Use the ladder to dismount from platform.
5. Turn main power disconnect switch to “|” on position.





• **Test Base Emergency Stop**

1. Push in “
  2. Pull out base “



• **Test Off/Platform/Base Switch**



**Be aware of overhead obstructions or other possible hazards around the aerial platform when lifting.**

1. Select off/platform/base key switch “
  2. Select off/platform/base key switch to “
    3. Select and hold off/platform/base key switch to “

• **Test Lower/Neutral/Raise Switch**

1. Select and hold off/platform/base key switch to “
  2. Select and hold off/platform/base key switch to “

SKYJACK, Page 26



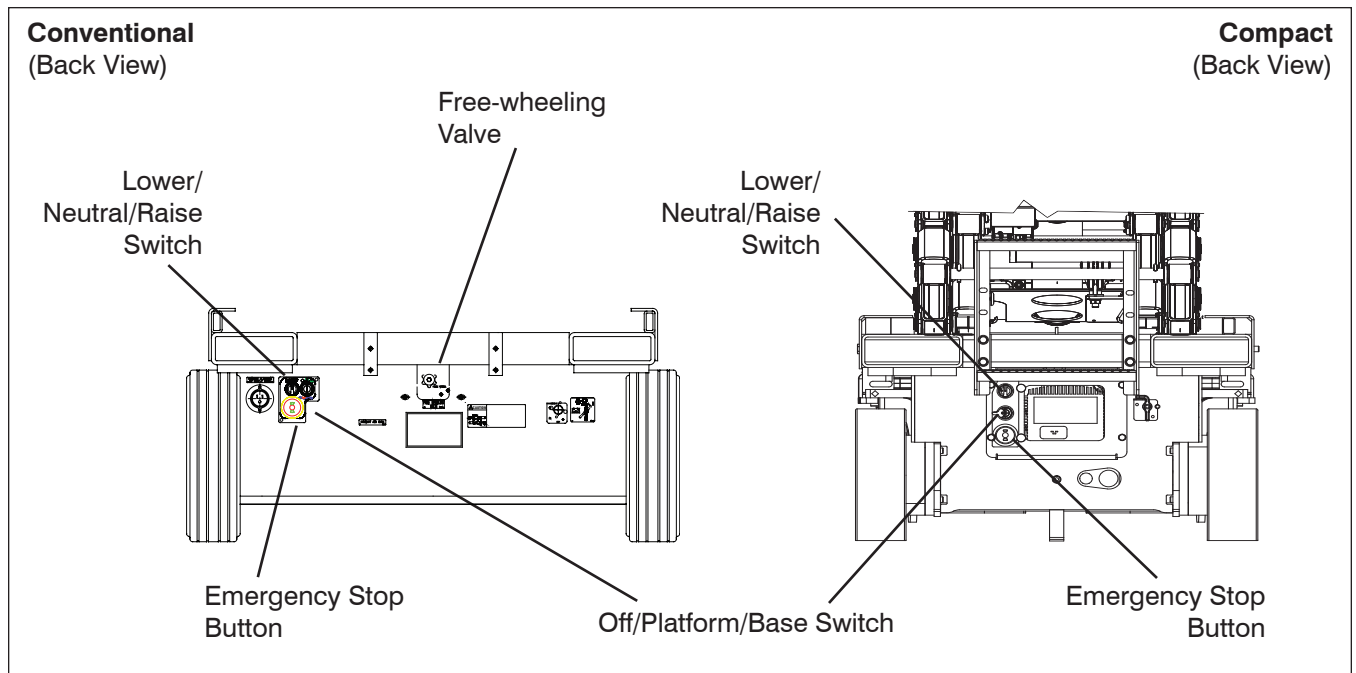

- **Test Emergency Lowering**

1. Raise the platform.
2. Locate holding valve manual override knob at the base of each lift cylinder. Depress and turn counterclockwise. If necessary, use access rod that is located on the base of the aerial platform.
3. On hydraulic/electric tray, pull out and hold emergency lowering valve to fully lower the platform.  
**Result:** The platform should lower.
4. To restore normal operation, depress and turn holding valve manual override knobs clockwise.

- **Test Free-wheeling**

1. Ensure path of intended motion is clear.
2. Release the brake manually.
3. Turn free-wheeling valve knob counterclockwise to a fully opened position and attempt to push/pull the aerial platform.  
**Result:** Platform should move.
4. Turn free-wheeling valve knob clockwise to a fully closed position for normal operation.
5. Reengage the brake.

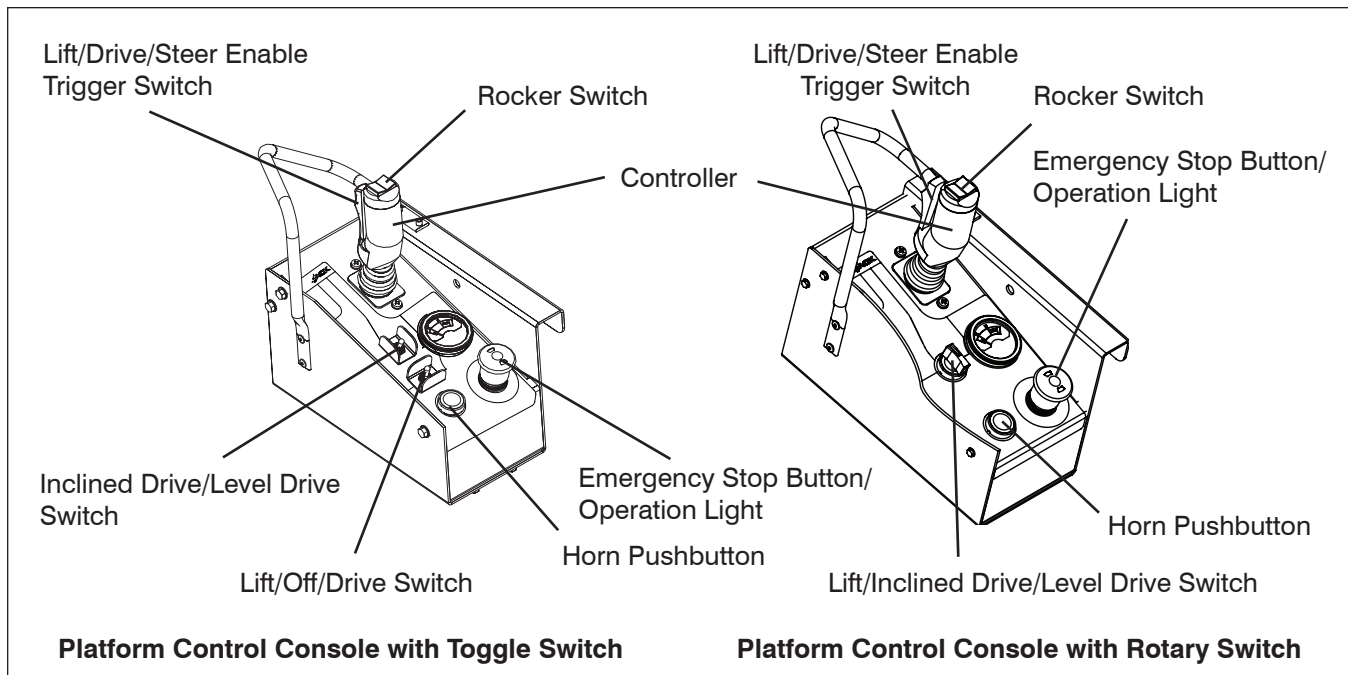

1.2-3 Platform Control Console

1. Ensure base “” emergency stop button is pulled out.
2. Select off/platform/base key switch to “” platform position.
3. Ensure main power disconnect switch is in “” on position.



**WARNING**

Ensure that you maintain three points of contact when using the ladder to mount/dismount platform.

4. Use the ladder of aerial platform to access platform.
5. Close the gate.
6. On platform control console, pull out “” emergency stop button.

• **Test Platform Emergency Stop**

1. Push in “” emergency stop button and attempt to activate any platform function.  
**Result:** All selected platform functions should not operate.

• **Test Enable Trigger Switch**

1. Pull out “” emergency stop button.
2. Without activating “” enable trigger switch, attempt to activate any platform function.  
**Result:** All platform functions should not operate.

• **Test Steering**

1. For platform control console with toggle switch:  
Select lift/off/drive switch to “” drive position.  
  
For platform control console with rotary switch:  
Select lift/inclined drive/level drive switch to either “” inclined drive (low speed/high torque) or “” level drive (high speed/low torque) position.
2. Activate and hold “” enable trigger switch.

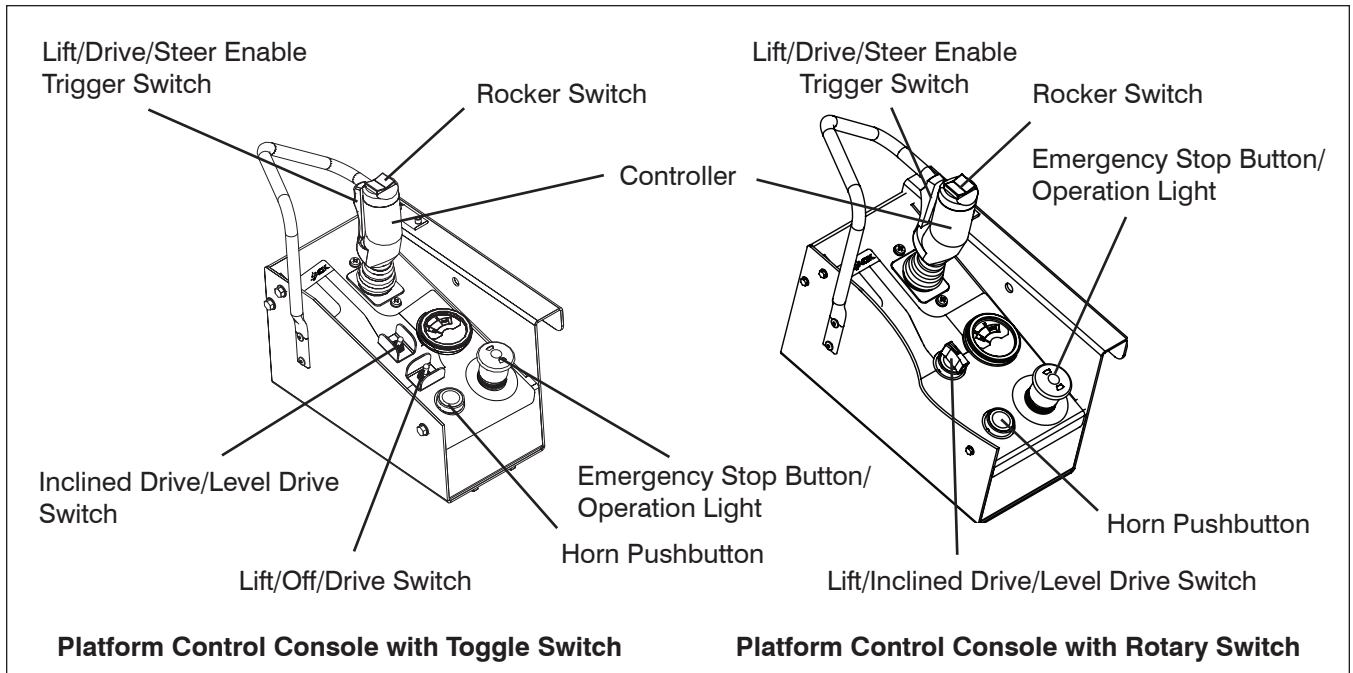

3. Press rocker switch on top of controller handle to “” left and “” right.  
**Result:** Steer wheels should turn left and right.

• **Test Driving**

1. Ensure path of intended motion is clear.
2. Activate and hold “” enable trigger switch.
3. Slowly move controller handle in “” forward direction until aerial platform begins to move, and then return handle to center position.  
**Result:** Aerial platform should move in forward direction, and then come to a stop.
4. Slowly move controller handle in “” reverse direction until aerial platform begins to move, and then return handle to center position.  
**Result:** Aerial platform should move in reverse direction, and then come to a stop.

• **Test Brakes**



**WARNING**

**Brakes will engage instantly when you release the controller handle, causing aerial platform to stop immediately.**

1. Ensure path of intended motion is clear.
2. Activate and hold “” enable trigger switch.
3. Drive aerial platform “” forward and then “” backward. Test brake by releasing controller handle.  
**Result:** Aerial platform should come to a stop. If aerial platform pulls to one side while stopping, do not operate aerial platform until brake adjustments have been checked.
4. Drive aerial platform “” forward and then “” backward. Test brake again by releasing “” enable trigger switch only.  
**Result:** Aerial platform should come to an instant and abrupt stop. If aerial platform does not stop immediately, or if aerial platform pulls to one side while stopping, do not operate aerial platform until brake adjustments have been checked.

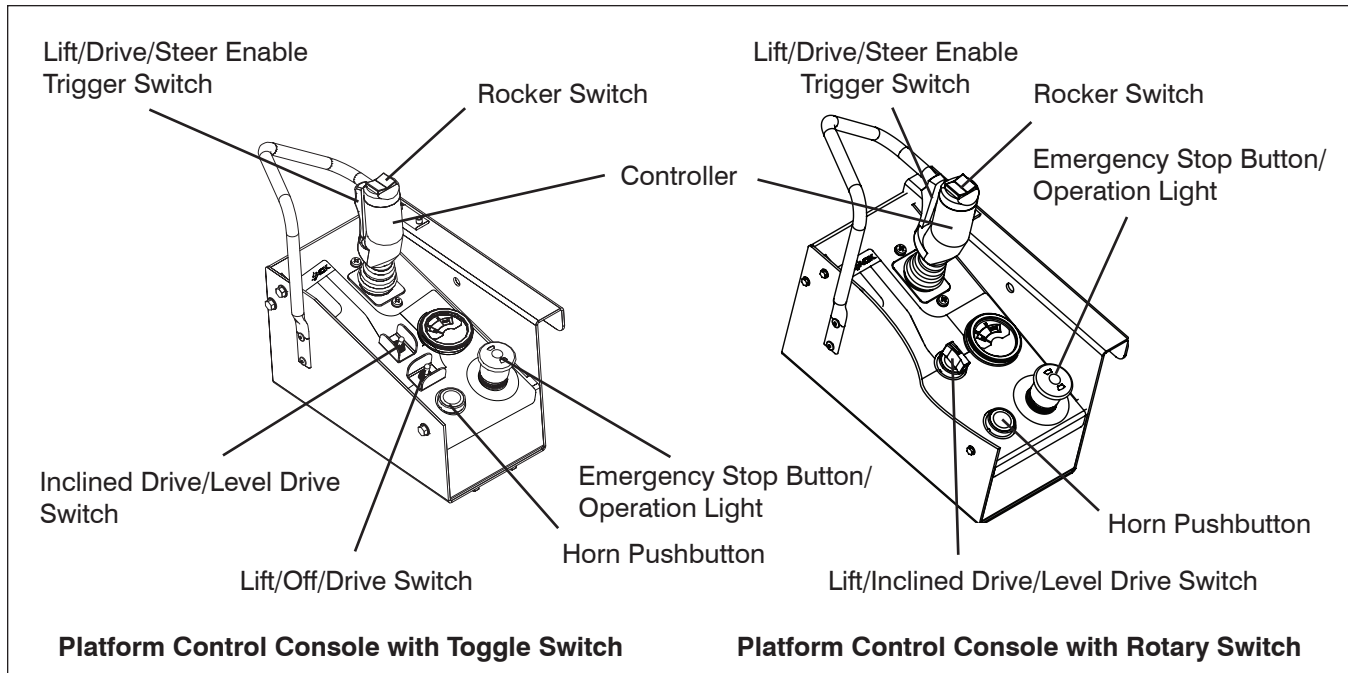



• **Test Platform Raising/Lowering**



**WARNING**

**Be aware of overhead obstructions or other possible hazards around the aerial platform when lifting.**

1. Select lift/inclined drive/level drive switch to “” lift position.
2. Activate and hold “” enable trigger switch.
3. Push controller handle and raise the platform to an approximate height of 0.5 meter.  
**Result:** Platform should rise.
4. Pull controller handle and lower the platform fully.  
**Result:** Platform should lower.

• **Test Lowering Warning**

1. Raise the platform until approximately a height of 3 to 4 meters is reached then attempt to fully lower the platform.  
**Result:** Platform should stop lowering at a height of 2.5 meters high and an alarm should sound.

2. Release controller handle.

• **Test Horn**

1. Push “” horn pushbutton.  
**Result:** Horn should sound.

## Compact

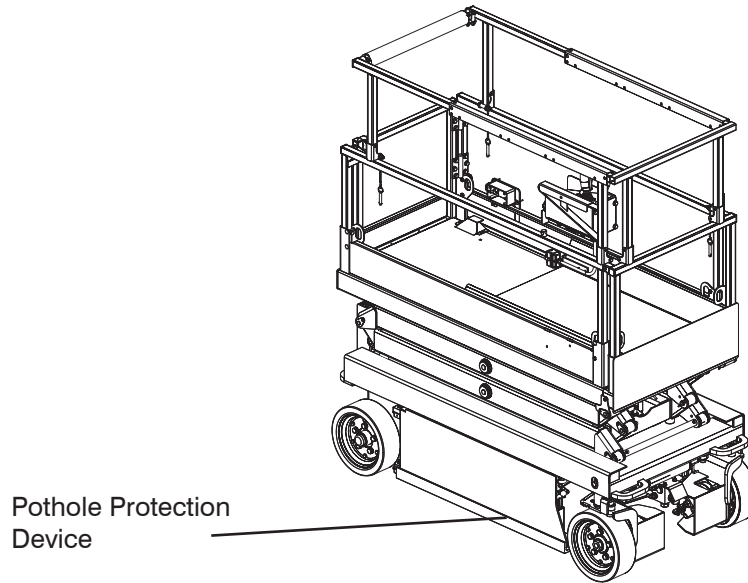

- **Test Pothole Sensor**

**WARNING**

**Ensure that you maintain three points of contact to mount/dismount platform.**

1. Use the ladder to dismount from platform and place a block, approximately 3.75 cm, under the hydraulic/electric tray.
2. Use the ladder of aerial platform to access platform.
3. Close the gate.
4. Raise the platform until approximately a height of 2 meters is reached and attempt to drive forward or reverse.  
**Result:** Aerial platform should not move forward or backward.
5. Repeat the steps above with block placed under battery tray.  
**Result:** Aerial platform should not move forward or backward.

- **Test Elevated Drive Speed**

**WARNING**

**Be aware of overhead obstructions or other possible hazards around the aerial platform when lifting.**

1. Ensure path of intended motion is clear.
2. Raise the platform until approximately a height of 2 meters is reached and attempt to drive forward or reverse.  
**Result:** Aerial platform should move slower than when it was in stowed position.

---

## Section 2 **MAINTENANCE TABLES AND DIAGRAMS**

### Table of Contents

#### Tables

2.1	Specifications and Features.....	2
2.2	Floor Loading Pressure.....	4
2.3	Maximum Platform Capacities (Evenly Distributed) .....	6
2.4	Torque Specifications .....	7



Table 2.1 Specifications and Features

MODEL	3215	3219	3220	3226
Weight *	1120 kg	1312 kg	1599 kg	1891 kg
Overall width	0.81 m		0.83 m	
Overall length	1.80 m		2.34 m	
Platform Size (inside)	0.66 m x 1.63 m		0.70 m x 2.10 m	
<b>Height</b>				
Working Height	6.5 m	7.8 m	8.0 m	9.9 m
Platform Elevated Height	4.5 m	5.8 m	6.0 m	7.9 m
Stowed Platform Height	0.88 m	0.99 m	0.97 m	1.14 m
Stowed Height (Railings Up)	1.99 m	2.11 m	2.10 m	2.25 m
Drive Height	FULL			
<b>Standard Operating Times</b>				
Lift Time (No Load)	17 s	18 s	27 s	49 s
Lower Time (No Load)	36 s	39 s	40 s	57 s
Lift Time (Rated Load)	22 s	21 s	33 s	53 s
Lower Time (Rated Load)	29 s	35 s	28 s	44 s
<b>Chassis</b>				
Normal Drive Speed	3.7 km/h		3.2 km/h	3.2 km/h
Elevated Drive Speed	1.1 km/h		1.1 km/h	1.1 km/h
High Torque Drive Speed	N/A		1.8 km/h	1.8 km/h
Gradeability (Ramp Angle)	30%	25%	30%	
Tires (Solid Rubber)	12 x 4 x 8		16 x 5 x 12	
<b>Hydraulic Oil</b>				
Type	ATF Dexron III			
Tank Capacity (Liters)	10.9		30	

130AA

\* Weight with standard 0.9m extension platform. Refer to serial nameplate for specific applications.

**Note :**

Emission sound pressure level does not exceed 70 dB(A).

Table 2.1 Specifications and Features (Continued)

MODEL	4620	4626	4632
Weight *	1980 kg	2170 kg	2300 kg
Overall width	1.2 m		
Overall length	2.3 m		
Platform Size (inside)	1.1 m x 2.1 m		
<b>Height</b>			
Working Height	8.1 m	9.9 m	11.8 m
Platform Elevated Height	6.1 m	7.9 m	9.8 m
Stowed Platform Height	1.0 m	1.1 m	1.2 m
Stowed Height (Railings Up)	1.96 m	2.15 m	2.24 m
Stowed Height (Railings Down)	1.6m	1.8m	1.9 m
Drive Height	6.1 m	7.9 m	9.7 m
<b>Standard Operating Times</b>			
Lift Time (No Load)	24 s	48 s	50 s
Lower Time (No Load)	48 s	45 s	62 s
Lift Time (Rated Load)	32 s	54 s	59 s
Lower Time (Rated Load)	32 s	32 s	49 s
<b>Chassis</b>			
Normal Drive Speed	3.2 km/h		
Elevated Drive Speed	1 km/h		
High Torque Drive Speed	1.6 km/h		
Gradeability (Ramp Angle)	30%		25%
Tires (Solid Rubber)	16 x 5 x 12		
<b>Hydraulic Oil</b>			
Type	ATF Dexron III		
Tank Capacity (Liters)	30		

131AA

\* Weight with standard 1.2m extension platform. Refer to serial nameplate for specific applications.

**Note :**

Emission sound pressure level does not exceed 70 dB(A).



**Table 2.2 Floor Loading Pressure**

MODEL		Total Aerial Platform Weight	Total Aerial Platform Load		
			Wheel	LCP**	OUP**
		kg	kg	kPa (kN/m <sup>2</sup> )	kPa (kN/m <sup>2</sup> )
3215	min*	1120	448	685.9	7.7
	max*	1347	539	742.4	9.2
3219	min*	1312	525	743.4	9.0
	max*	1539	615	782.0	10.6
3220	min*	1542	616	758.5	8.5
	max*	1950	780	896.5	11.5
3226	min*	1896	746	827.5	10.0
	max*	2091	836	896.5	11.5
4620	min*	1922	744	1316.9	7.0
	max*	2568	1021	1530.6	9.5
4626	min*	2173	853	1420.3	8.0
	max*	2627	1075	1544.4	10.1
4632	min*	2303	921	1434.1	8.6
	max*	2620	1048	1537.5	9.8

133AB

\* **min** - Total aerial platform weight with no options

**max** - Aerial platform weight + all options + full capacity

\*\* **LCP - Locally Concentrated Pressure** is a measure of how hard the aerial platform presses on the areas in direct contact with the floor. The floor covering (tile, carpet, etc.) must be able to withstand more than the indicated values above.

**OUP - Overall Uniform Pressure** is a measure of the average load the aerial platform imparts on the whole surface directly underneath it. The structure of the operating surface (beams, etc.) must be able to withstand more than the indicated values above.

**NOTE:**

The **LCP** or **OUP** that an individual surface can withstand varies from structure to structure and is generally determined by the engineer or architect for that particular structure.

**Floor Loading Pressure**

**Locally Concentrated Pressure (LCP):**

Foot Print Area = Length x Width

$$LCP = 0.4 \times \frac{\text{Weight of Aerial Platform} + \text{Capacity}}{\text{Foot Print Area}}$$

**Overall Uniform Pressure (OUP):**

Base Area = Length x Width

$$OUP = \frac{\text{Weight of Aerial Platform} + \text{Capacity}}{\text{Base Area}}$$

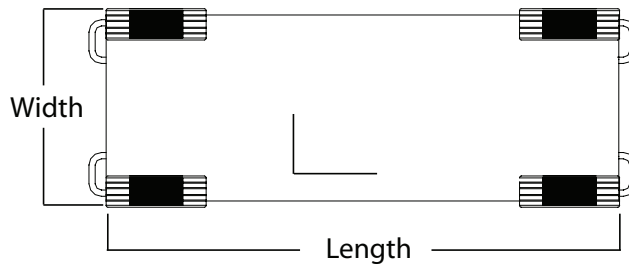
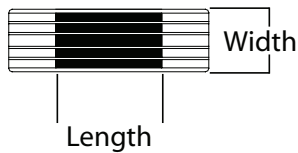
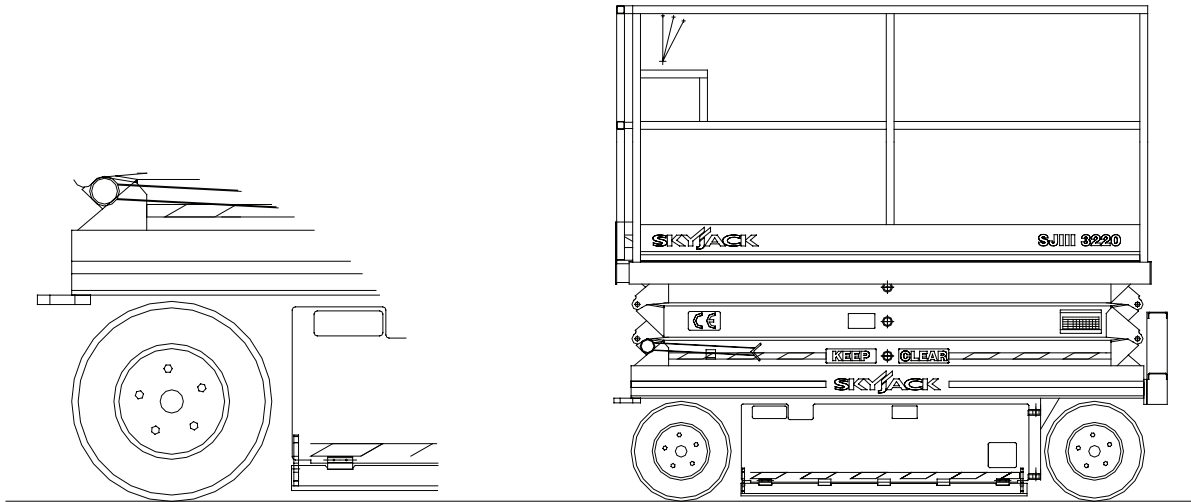

**! WARNING**

**Intermixing tires of different types or using tires of types other than those originally supplied with this equipment can adversely affect stability. Therefore, replace tires only with the exact original Skyjack-approved type. Failure to operate with matched approved tires in good condition may result in death or serious injury.**

**Table 2.3 Maximum Platform Capacities (Evenly Distributed)**

MODEL	Manual Extension Platform				Powered Extension Platform				Maximum Wind Speed	Tilt Cutout Setting
	Total Capacity		Extension Capacity		Total Capacity		Extension Capacity			
3215	227 kg	2 Persons	113 kg	1 Person	N/A				No Wind	1.5 x 3.5
	227 kg	1 Persons	113 kg	1 Person					9.4 m/s	
3219	227 kg	2 Persons	113 kg	1 Person	N/A				No Wind	1.5 x 3.5
	227 kg	1 Persons	113 kg	1 Person					9.4 m/s	
3220	408 kg	2 Persons	113 kg	1 Person	408 kg	2 Persons	113 kg	1 Person	No Wind	1.5 x 3.5
3226	227 kg	2 Persons	113 kg	1 Person	N/A				No Wind	1.5 x 3.5
4620	590 kg	3 Persons	136 kg	1 Person	N/A				12.5 m/s	1.5 x 3.5
4626	454 kg	2 Persons	136 kg	1 Person	N/A				12.5 m/s	1.5 x 3.5
4632	317 kg	2 Persons	113 kg	1 Person	N/A				No Wind	1.5 x 3.5
	317 kg	1 Person	113 kg	1 Person					9.4 m/s	

132AB

**NOTE:** Overall Capacity - Occupants and materials not to exceed rated load.

BEAUFORT SCALE	Wind Speed				Ground Conditions
	m/s	km/h	ft/s	mph	
3	3.4 – 5.4	12.5 – 19.4	11.5 – 17.75	8 – 12	Papers and thin branches move, flags wave
4	5.4 – 8.0	19.4 – 28.8	17.75 – 26.25	13 – 17	Dust is raised, paper whirled up, and small branches sway.
5	8.0 – 10.8	28.8 – 38.9	26.25 – 35.5	18 – 24.25	Shrubs with leaves start swaying. Wave crests are apparent in ponds or swamps.
6	10.8 – 13.9	38.9 – 50.0	35.5 – 45.5	24.5 – 31	Tree branches move. Power lines whistle. It is difficult to open an umbrella.
7	13.9 – 17.2	50.0 – 61.9	45.5 – 56.5	31 – 38.5	Whole trees sway. It is difficult to walk against the wind.

138AA-CE



**WARNING**

**This aerial platform is equipped with a load sensing system. Do not exceed the rated capacity of the aerial platform. Failure to avoid this will prevent operation of all normal controls/functions of the aerial platform. To resume normal operation remove the additional loads.**

AD

Table 2.4 Torque Specifications

Directional valve mounting bolts	28-32 in-lb			2.2 – 3.6 Nm				
Wheel mounting bolts	90 ft-lb			122.02 Nm				
<b>Cartridge</b>								
	<b>Size</b>							
<b>Torque</b>	08	38	58	10	12	16		
Ft-lb (max)	20	20	20	25	35	50		
In-lb (max)	240	240	240	300	420	600		
Nm (max)	27.12	27.12	27.12	33.90	47.46	67.80		
<b>Coils</b>								
	<b>Size</b>							
<b>Torque</b>	All coils							
Ft-lb (max)	4 to 5							
In-lb (max)	48 to 60							
Nm (max)	5.42 to 6.78							
<b>SAE Plugs</b>								
	<b>Size</b>							
<b>Torque</b>	2	4	5	6	8	10	12	16
Ft-lb (max)	3	10	15	15	25	25	30	35
In-lb (max)	36	120	180	180	300	300	360	420
Nm (max)	4.07	13.56	20.34	20.34	33.90	33.90	40.68	47.46
<b>Newton-meter = Nm</b>		<b>Foot-pound = ft-lb</b>			<b>Inch-pound = in-lb</b>			
Additional Torque Specifications may be found in Section 3.								

60056AF

---

## **Section 3**

# **SYSTEM COMPONENT IDENTIFICATION AND SCHEMATICS**

### **Table of Contents**

#### **Charts**

3.1	Electrical Symbol Chart .....	3
3.2	Hydraulic Symbol Chart.....	4
3.3	Wire Number and Color Code .....	5









































#### **Parts List**

3.4	Hydraulic Schematic Parts List.....	6
3.5	Electrical Component Parts List .....	7



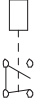
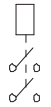
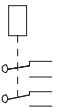
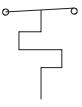
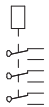













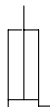

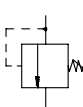
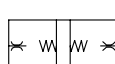







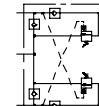



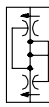

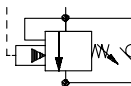

#### **Diagrams and Schematics**

3.6	Hydraulic Manifold and Port Identifications.....	10
3.7a	Platform Control Console Diagram .....	11
3.7b	Platform Control Console Diagram .....	12
3.8	Base Control Console Diagram.....	13
3.9	Scissor Arm Control Cable .....	14
3.10	Electrical Inverter Schematic & Panel Diagram (Equipped with timer cutout relay) .....	15
3.11	Disc Brake Kits and Torque Specifications.....	17
3.12	Hydraulic Schematic.....	18
3.13	Main Manifold Harness and Holding Valve Harness.....	19
3.14	Electrical Panel Diagram.....	20
3.15	Limit Switch Assemblies Diagram .....	21
3.16	Control Module and Beeper Diagram .....	22
3.17a	Electrical Schematic - Equipped with all options (Toggle Switch).....	23
3.17b	Electrical Schematic - Equipped with all options (Rotary Switch) .....	24

3.1 Electrical Symbol Chart

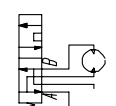
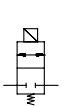
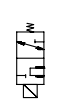
	CIRCUITS CROSSING NO CONNECTION		HOURMETER		KEY SWITCH		LIMIT SWITCH N.O.
	CIRCUITS CONNECTED		LIGHT		FOOT SWITCH		LIMIT SWITCH N.O. HELD CLOSED
	BATTERY		HYDRAULIC VALVE COIL		TOGGLE SWITCH		LIMIT SWITCH N.C.
	GROUND		PROPORTIONAL HYDRAULIC VALVE COIL		PUSH BUTTON		LIMIT SWITCH N.C. HELD OPEN
	FUSE		ELECTRIC MOTOR		ROTARY SWITCH		SILICON CONTROLLED RECTIFIER
	CIRCUIT BREAKER		HORN		LIMIT SWITCH		PROXIMITY SWITCH
	VOLT METER		EMERGENCY STOP BUTTON		CAM OPERATED LIMIT SWITCH		PNP TRANSISTOR
	CAPACITOR		RESISTOR		VARIABLE RESISTOR		NPN TRANSISTOR
	POTENTIOMETER		LEVEL SENSOR		SINGLE POLE SINGLE THROW RELAY		PRESSURE/ VACUUM SWITCH
	SINGLE POLE DOUBLE THROW RELAY		DOUBLE POLE SINGLE THROW RELAY		DOUBLE POLE DOUBLE THROW RELAY		TEMPERATURE SWITCH
	TRIPLE POLE DOUBLE THROW RELAY		DIODE		RHEOSTAT		TILT SWITCH

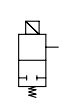
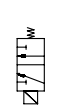
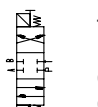
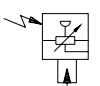
3.2 Hydraulic Symbol Chart

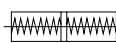
	LINE CROSSING		VARIABLE DISPLACEMENT PUMP		SHUTTLE VALVE		VELOCITY FUSE
	LINE JOINED		HAND PUMP		ACCUMULATOR, GAS CHARGED		SINGLE ACTING CYLINDER
	HYDRAULIC TANK		RELIEF VALVE		CUSHION CYLINDER		DOUBLE ACTING CYLINDER
	HYDRAULIC FILTER WITH BYPASS		PRESSURE REDUCING VALVE		PRESSURE SWITCH		DOUBLE ACTING DOUBLE RODDED CYLINDER
	ELECTRIC MOTOR		FIXED ORIFICE		MOTION CONTROL VALVE		SPRING APPLIED HYDRAULIC RELEASED BRAKE
	ENGINE		ADJUSTABLE FLOW CONTROL		FLOW DIVIDER COMBINER		BRAKE CYLINDER
	FIXED DISPLACEMENT PUMP		CHECK VALVE		COUNTER BALANCE VALVE		ROTARY ACTUATOR
	VARIABLE DISPLACEMENT HYDRAULIC MOTOR		OIL COOLER		VALVE COIL		BI DIRECTIONAL HYDRAULIC MOTOR
	SERIES PARALLEL HYDRAULIC MOTOR		TWO POSITION TWO WAY NORMALLY CLOSED VALVE		TWO POSITION THREE WAY VALVE		THREE POSITION FOUR WAY CLOSED CENTER OPEN PORT
	TWO POSITION TWO WAY NORMALLY OPEN VALVE		TWO POSITION THREE WAY VALVE		THREE POSITION FOUR WAY CLOSED CENTER CLOSED PORT		
	PRESSURE TRANSDUCER		MAIN LINES Solid		PILOT LINES Dashed		
	SERVO						

3.3 Wire Number and Color Code

WIRE NO.	WIRE COLOR	WIRE NO.	WIRE COLOR	WIRE NO.	WIRE COLOR	WIRE NO.	WIRE COLOR	WIRE NO.	WIRE COLOR
00	WHT	20	ORG/BLU	44	YEL/WHT	67	ORG/BRN	92	GRN SHLD
000	WHT	21	WHT/RED	45	YEL/ORG	68	GREY	93	BLK SHLD
B1	BLU/PINK	23	BLK/WHT	46	RED/BLK	69	WHT/GRN	95	YEL/GREY
01	PUR/BLK	24	BLU/BLK	47	PUR/ORG	70	ORG/PINK	96	WHT/GREY
02	WHT	25	BRN/BLK	48	YEL/GREY	71	RED/ORG	97	ORG/GREY
03	GRN/PUR	26	BLU/YEL	49	GRN/RED	72	RED/BRN	98	RED SHLD
04	RED/YEL	27	RED/BLK/WHT	50	BRN	73	RED/PINK	98A	BLK SHLD
05	PUR	28	GRN	51	BLK/GRN	74	GRN/GREY	99	BLK/GREY
06		29	GREY/ORG	52	GRN/BLU	75	GREY/PUR	103	BLK/PUR
07	RED	30	RED/GRN	53	BRN/RED	76	BRN/BLU	104	GRN/ORG
08	PUR/WHT	31	RED/WHT	54	PUR/RED	77	BRN/GREY	105	GRN/BRN
09	YEL	32	GRN/BLK	55	YEL/PUR	78	RED/BLU	106	GRN/PINK
10	BLU/WHT	33	GRN/WHT	56	YEL/BLK	79	BRN/PUR	107	BLK/BLU
11	WHT/ORG	34	ORG/BLK	57	BRN/GRN	80	GREY/WHT	108	YEL/BRN
12	RED/YEL/BLK	35	ORG/WHT	58	WHT/PUR	81	GREY/BLK	109	GRN/YEL
13	ORG	36	RED/PUR	59	YEL/BLU	82	BRN/WHT	110A	BLU
14	BLK	37	WHT/RED/BLK	60	WHT/BLU	83	BLU/GREY	110B	BRN
15	BLU	38	ORG/RED	61	GREY/BRN	84	WHT/BLK/PUR	111	GREY/GRN
16	WHT/BLK	39	BLK/RED	62	GREY/RED	85	GREY/BLU	112	BLU/ORG
17	BLU/GRN	40	BLU/RED	63	GREY/YEL	86/87	PUR/BLU	113	BLU/BRN
18	GRN/BLU	41	BLU/PUR	64	WHT/BRN	88	BLK/ORG	114	YEL/RED
19	ORG/GRN	42	PINK	65	YEL/PINK	90	RED/GREY	115	WHT/PUR
22	PUR/GRN	43	WHT/YEL	66	ORG/YEL	91	RED SHLD	118	PUR/PINK

This table is to be used as a wire number/color reference for all electrical drawings and schematics. All wire numbers will retain their original color coding, for example if wire 7 is red, wire 7A, 7B, and 7C will also be red.



## 3.4 Hydraulic Schematic Parts List

AB

Index No.	Skyjack Part No.	Qty.	Description
2H-13B	103655	1	VALVE, Control (Lowering)
2H-13C	134822	1	VALVE, Control (Deceleration) <b>(Model 3215)</b>
2H-13B-1	107269	1	VALVE, Control (Holding)
2H-25	128113	1	VALVE, Control (Cushion)
2H-59B	132749	1	VALVE, Control (Proportional)
3H-14	106273	1	VALVE, Control (Lift)
3H-17	103623	1	VALVE, Control (Brake)
4H-15	153334	1	VALVE, Control (Reverse drive) (Hytos) (includes 4H-16)
4H-16	-	1	VALVE, Control (Forward drive) (Hytos)
4H-23	153334	1	VALVE, Control (Right steer) (Hytos) (includes 4H-24)
4H-24	-	1	VALVE, Control (Left steer) (Hytos)
C2	130709	1	CYLINDER (Lift)
C3	121087	1	CYLINDER (Steer)
CB1	147888	1	VALVE, Counterbalance (2750 psi)
F1	109568	1	FILTER, Return
M1	139412	1	MOTOR, Hydraulic drive (White Hydraulics)
M2	139412	1	MOTOR, Hydraulic drive (White Hydraulics)
MB1	107354	1	BLOCK, Manifold (Main)
MB2	139307	1	BLOCK, Manifold (Steering)
MB3	103615	1	BLOCK, Manifold (Cushion valve)
MB4	130481	1	BLOCK, Manifold (Holding valve)
MB5	129656	1	BLOCK, Manifold (Lowering valve)
MB9	132748	1	BLOCK, Manifold (Proportional control)
MB10	136419	1	BLOCK, Manifold (Deceleration valve) <b>(Model 3215)</b>
O2	130046	1	ORIFICE (0.063" diameter) (Lowering) <b>(Model 3219)</b>
O3	108002	1	ORIFICE (0.040" diameter) (Cushion)
O5	108002	2	ORIFICE (0.04" diameter) (Steering)
O6	105281	1	ORIFICE (0.067" diameter) (Emergency Lowering)
O7	147656	1	ORIFICE (0.024" diameter) (Drive)
P1	147661	1	PUMP, Hydraulic
PT1	134431	1	TRANSDUCER, Pressure (2000 psi) <b>(Model 3215)</b>
	134432	1	TRANSDUCER, Pressure (3000 psi) <b>(Model 3219)</b>
R1	104534	1	VALVE, Relief (System)
R2	104534	1	VALVE, Relief (Lift)
V1	107271	1	VALVE (Emergency lowering)
V2	103136	1	VALVE (Free-wheeling)

### 3.5 Electrical Component Parts List

AB

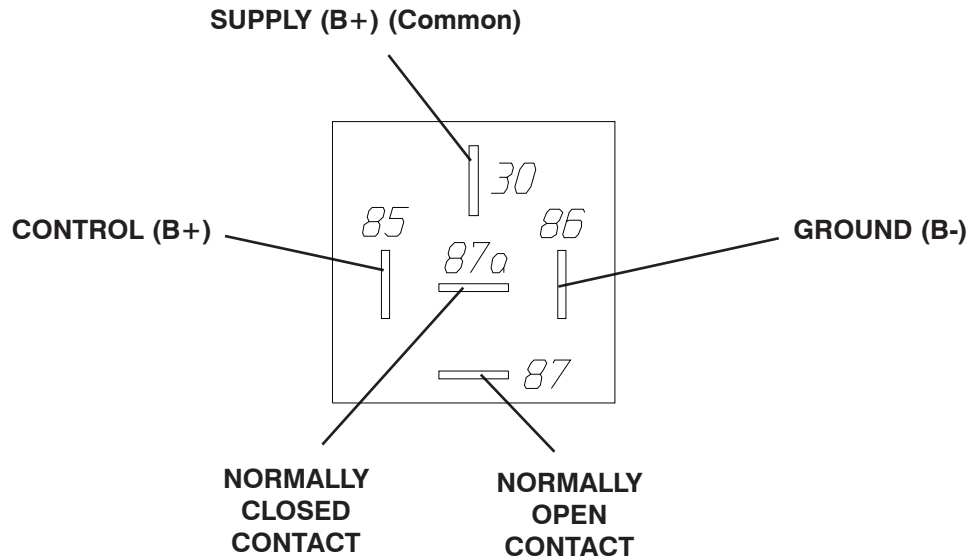

Index No.	Skyjack Part No.	Qty.	Description
17CCR	108589	1	RELAY, 24 Volt (Cushion)
17CR	108589	1	RELAY, 24 Volt (Steer)
17CR1	108589	1	RELAY, 24 Volt (Transfer)
21ACR	108589	1	RELAY, 24 Volt (Proportional)
28CR1	108589	1	RELAY, 24 Volt (Tilt switch)
28CR2	108589	1	RELAY, 24 Volt (Down)
28ECR1	108589	1	RELAY, 24 Volt (Auxillary tilt)
28ECR2	108589	1	RELAY, 24 Volt (Auxillary down)
L1CR	127154	1	RELAY, 12 Volt (Charger cutout)
2H-13B	103605	1	COIL, 24 Volt (Lowering valve)
2H-13C	137006	1	COIL, 24 Volt (Deceleration valve) <b>(Model 3215)</b>
2H-13B-1	104493	1	COIL, 24 Volt (Holding valve)
2H-25	103605	1	COIL, 24 Volt (Cushion)
2H-59	115370	1	COIL, 24 Volt (Proportional valve)
3H-14	106273	1	COIL, 24 Volt (Lift valve)
3H-17	103623	1	COIL, 24 Volt (Brake valve)
4H-15	153335	1	COIL, 24 Volt (Reverse drive spool valve) (Hytos)
4H-16	153335	1	COIL, 24 Volt (Forward drive spool valve) (Hytos)
4H-23	153335	1	COIL, 24 Volt (Right steer spool valve) (Hytos)
4H-24	153335	1	COIL, 24 Volt (Left steer spool valve) (Hytos)
B1-B4	\$	4	BATTERY, 6 Volt <b>(Trojan #T2200)</b>
AT1	130440	1	TRANSDUCER, Angle

**Parts list continued on the following page.**

## 3.5 Electrical Component Parts List (Continued)

AC

Index No.	Skyjack Part No.	Qty.	Description
<b>Parts list continued from the following page.</b>			
BC	152070	1	CHARGER, Battery (24 Volt)
BCI	122093	1	BATTERY CHARGE INDICATOR
BP-29	117967	1	BEEPER (28 Volt)
C1	146475	1	CONTACTOR, Motor (24 Volt)
CAP1	103319	1	CAPACITOR (1000 uF, 35 Volt)
CB1	117325	1	CIRCUIT BREAKER (15 Amp)
CB2	117325	1	CIRCUIT BREAKER (15 Amp)
CM1	130439	1	CONTROL MODULE, Integrated sensor
CRD1	146640	-	PLATFORM CONTROL CABLE ASSEMBLY
CRD2	146592	-	SCISSOR ARM CONTROL CABLE ASSEMBLY <b>(Model 3219)</b>
	146601	-	SCISSOR ARM CONTROL CABLE ASSEMBLY <b>(Model 3215)</b>
CRD3	146585	-	ELECTRIC PANEL CONTROL CABLE ASSEMBLY
DM1	128196	1	DIODE MODULE
DCM1	147664	1	MOTOR, 24 Volt
F1	310517	1	FUSE, 300 Amp
FL-22	121477	1	FLASHING LIGHT 24VDC (superior universal)
H1	146649	1	HORN, Operator (Low tone)
LED-1	147061	1	POWER INDICATOR LIGHT (Platform control console)
LED-2	147061	1	POWER INDICATOR LIGHT (Base control console)
LS1B	121975	1	LIMIT SWITCH (High speed)
LS4	139228	1	LIMIT SWITCH (Pothole protection) <b>(Battery tray)</b>
LS5	139227	1	LIMIT SWITCH (Pothole protection) <b>(Hydraulic tray)</b>
LS6	121975	1	LIMIT SWITCH (Drive override)
LS7	121975	1	LIMIT SWITCH (Deceleration)
PT1	134431	1	TRANSDUCER, Pressure (2000 psi) <b>(Model 3215)</b>
	134432	1	TRANSDUCER, Pressure (3000 psi) <b>(Model 3219)</b>
RST1	119629	1	RESISTOR (2.7K Ohms)
RST2	144714	1	RESISTOR, Variable (20 Ohms, 25W)
RST3	116505	1	RESISTOR, Low voltage protection
S1	119725	1	SWITCH, Main power disconnect
S2	147054	2	N.O. CONTACT (Raise/Lower)
S3	147053	3	N.C. CONTACT (Lift/Drive) (If equipped)
	147054	3	N.O. CONTACT (Lift/Drive) <b>(without power extension platform)</b> (If equipped)
		4	N.O. CONTACT (Lift/Drive) <b>(with power extension platform)</b> (If equipped)
	116382	1	SWITCH, Toggle (Lift/Off/Drive)
S4	147053	2	N.C. CONTACT (Emergency stop) <b>(Platform control console)</b>
S7	123994	1	CONTROLLER ASSEMBLY, Proportional
S7-1	122869	1	SWITCH, Neutral
S7-2	122877	1	SWITCH, Right steer
S7-3	122877	1	SWITCH, Left steer
<b>Parts list continued on the following page.</b>			

AC

3.5 Electrical Component Parts List (Continued)

Index No.	Skyjack Part No.	Qty.	Description
<b>Parts list continued from the following page.</b>			
S7-6	122872	1	SWITCH, Enable pushbutton
S8	147054	1	N.O. CONTACT (Horn)
S10	147053	2	N.C. CONTACT (Off/Platform)
	147054	1	N.O. CONTACT (Base)
S27	115574	1	SWITCH, Toggle (Inclined Drive/Level Drive)
S28	147053	1	N.C. CONTACT (Emergency stop) (Base control console)
TT	103336	1	HOURMETER
\$ - Purchase locally.			

3.6 Hydraulic Manifold and Port Identifications

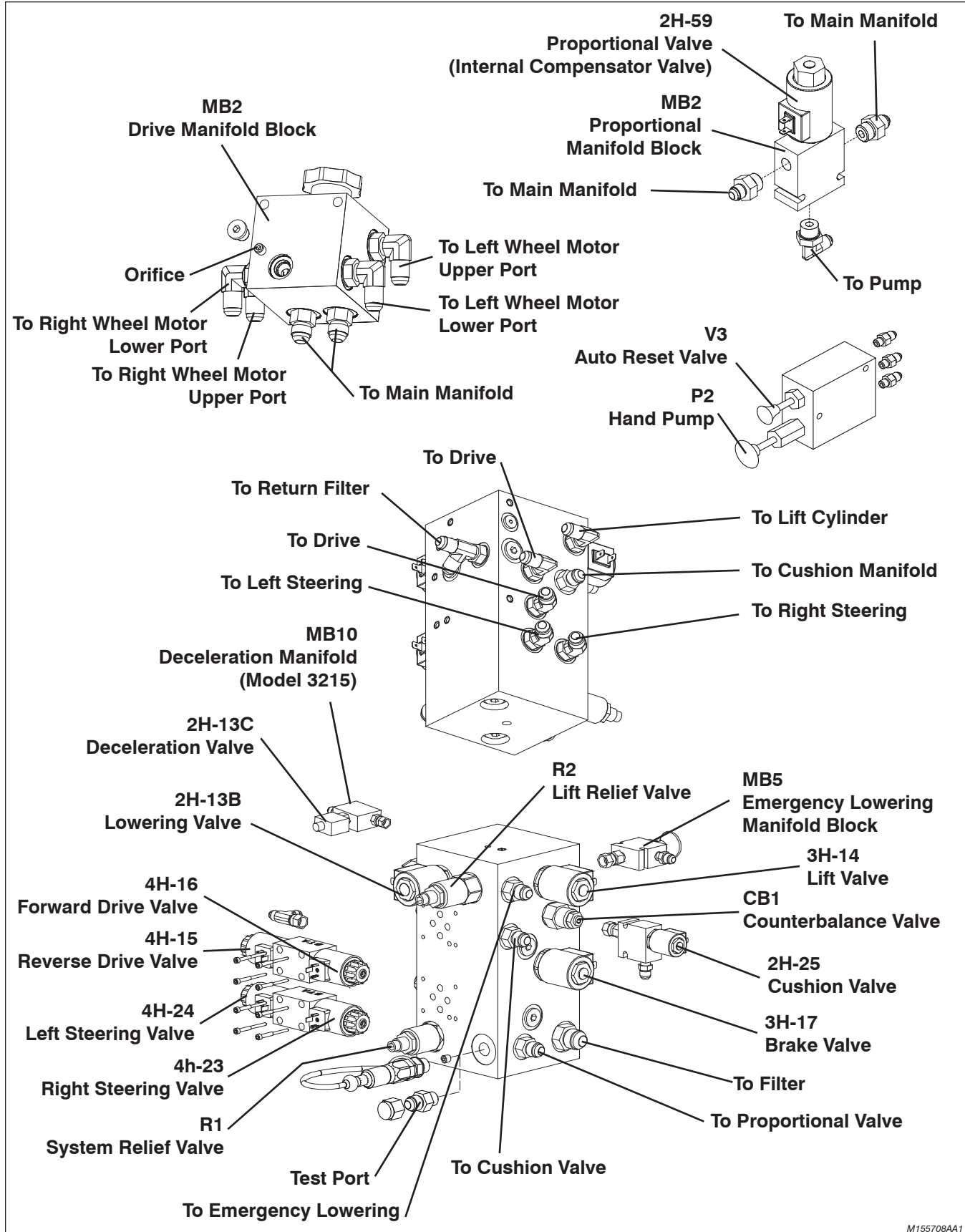

M155708AA1

3.7a Platform Control Console Diagram

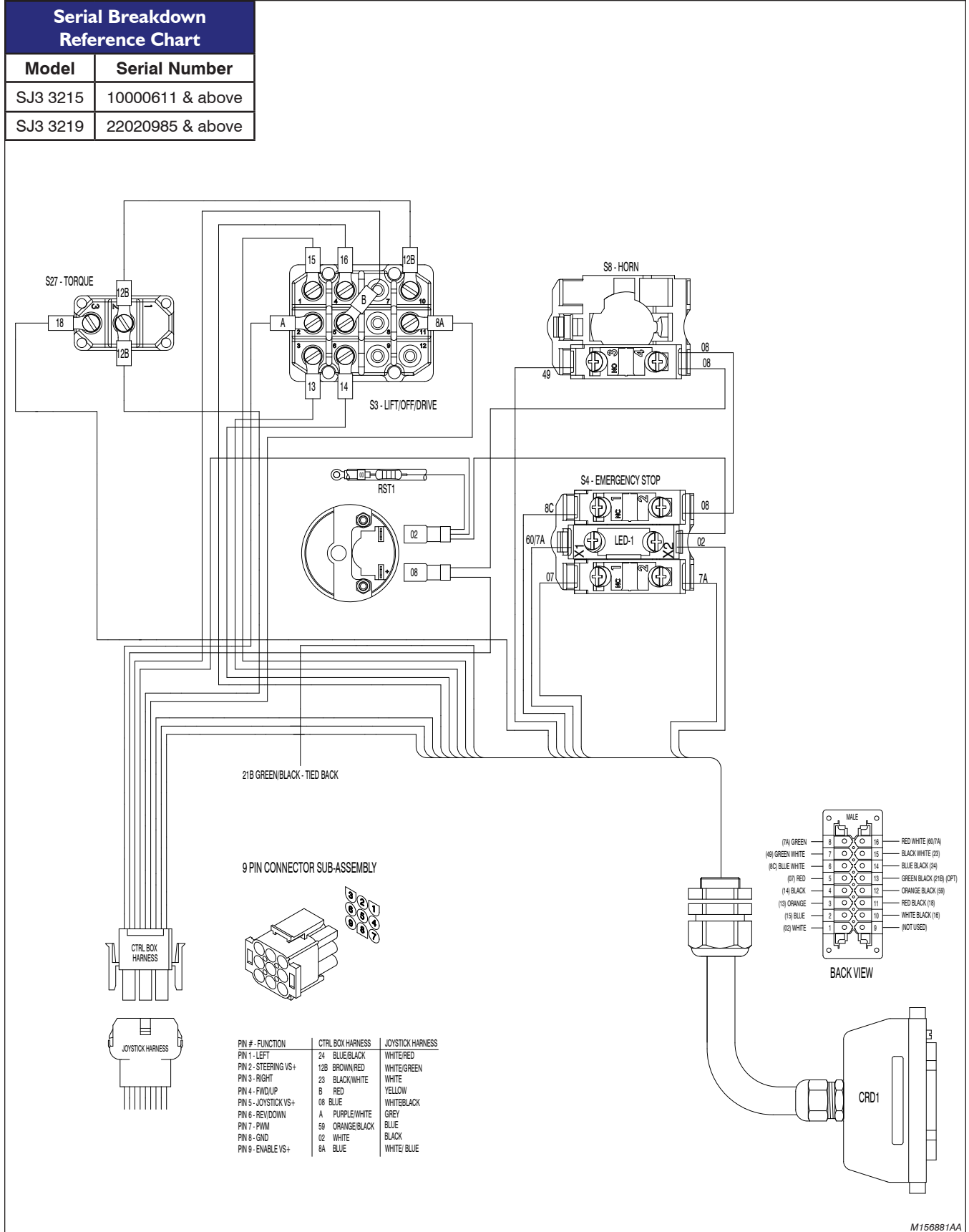

M156881AA

3.7b Platform Control Console Diagram

Serial Breakdown Reference Chart	
Model	Serial Number
SJ3 3215	10000610 & below
SJ3 3219	22020984 & below

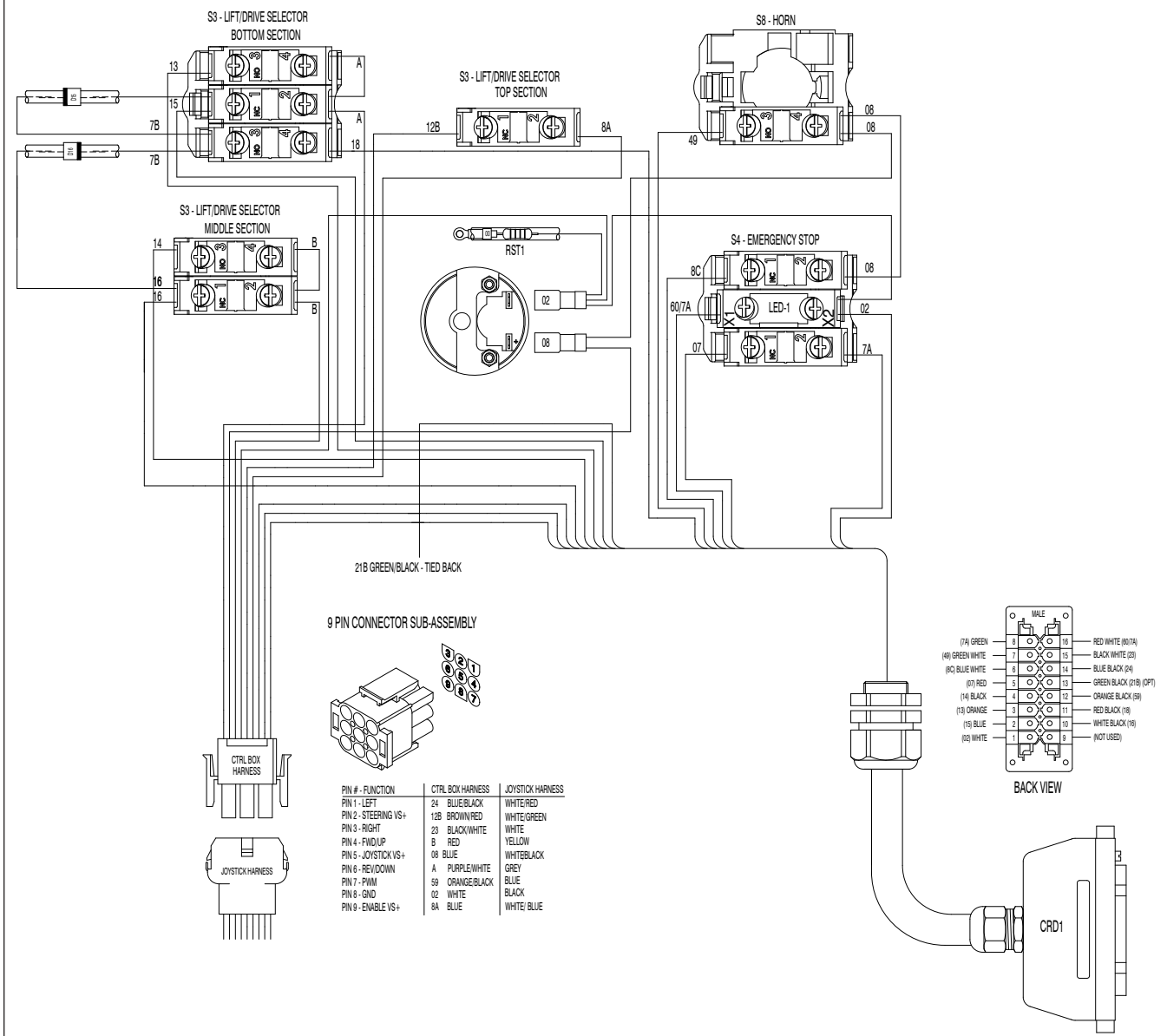

M146621AB

3.8 Base Control Console Diagram

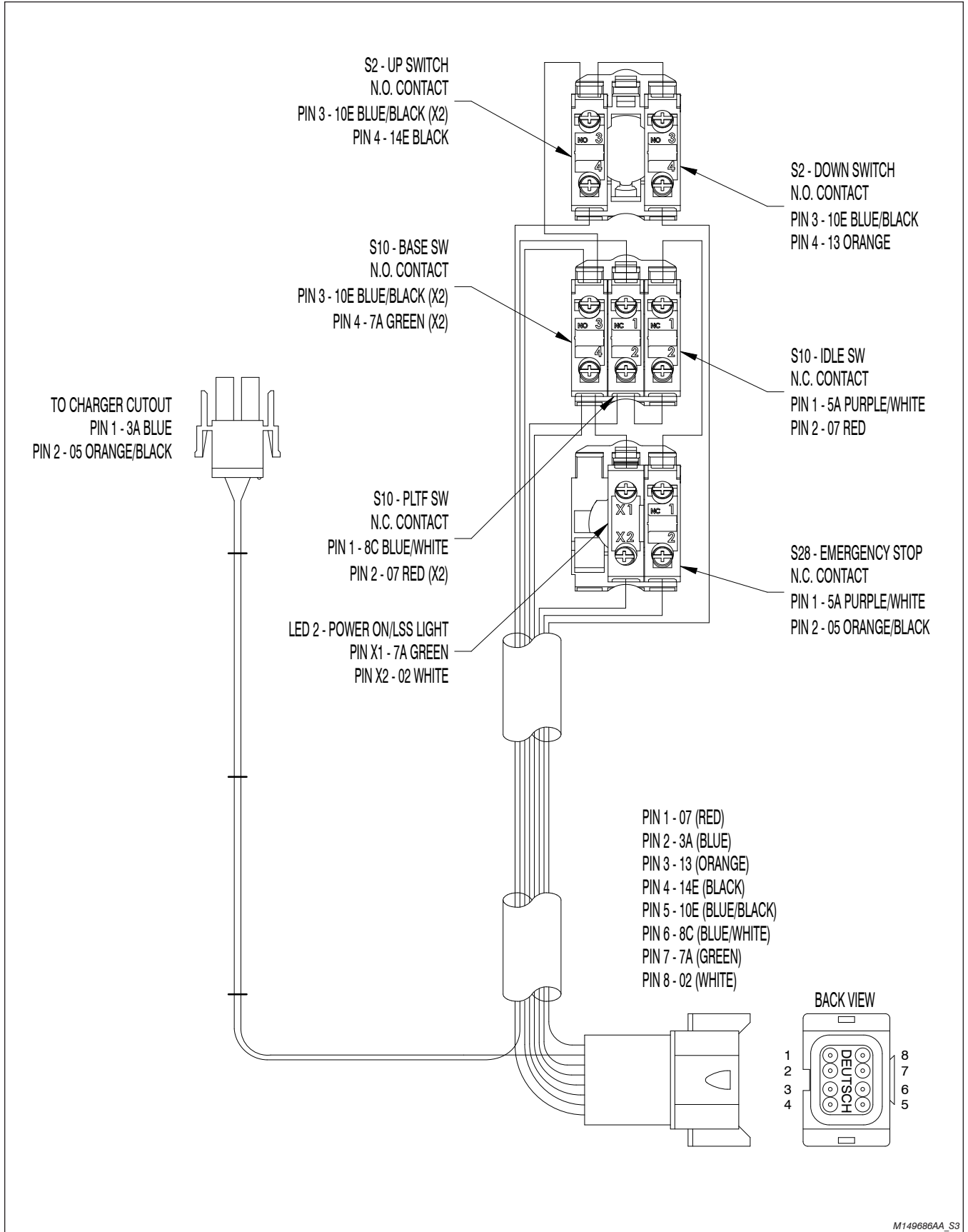

M149686AA\_S3



3.9 Scissor Arm Control Cable

CONTROL CABLE OPTIONS		
WIRE COLOUR	EUROPE WIRE NUMBER	N.A WIRE NUMBER
GREEN/BLACK	21B	21B
RED/WHITE	60	7A

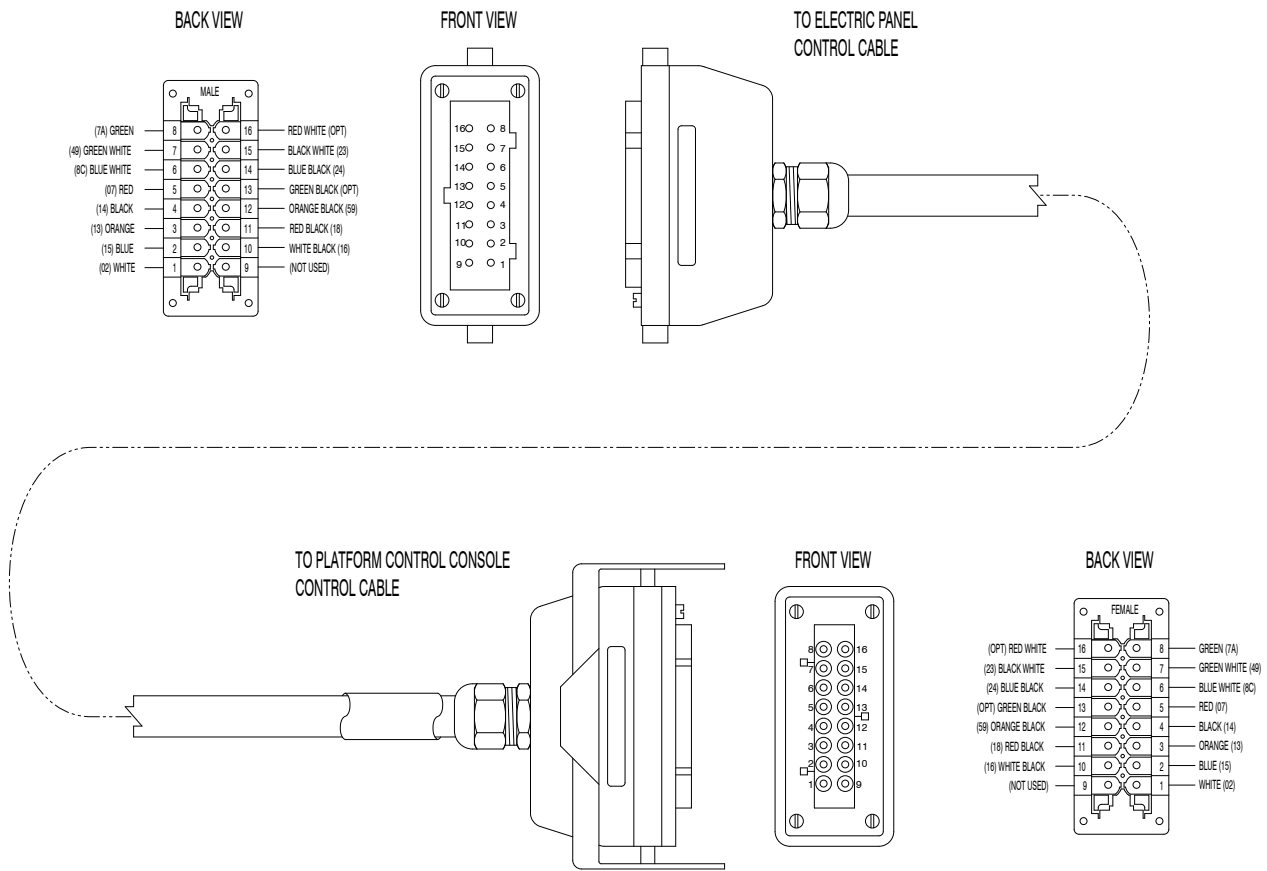

M146650AB\_S3

3.10 Electrical Inverter Schematic & Panel Diagram (Equipped with timer cutout relay)

AB

Electrical Schematic

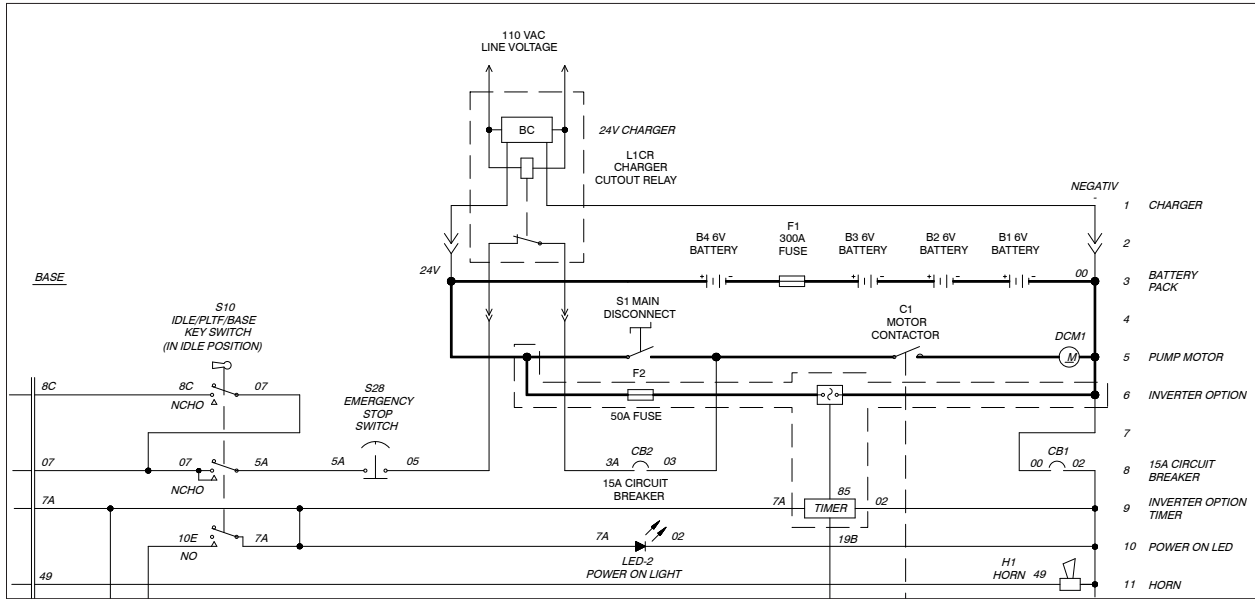

Electrical Panel

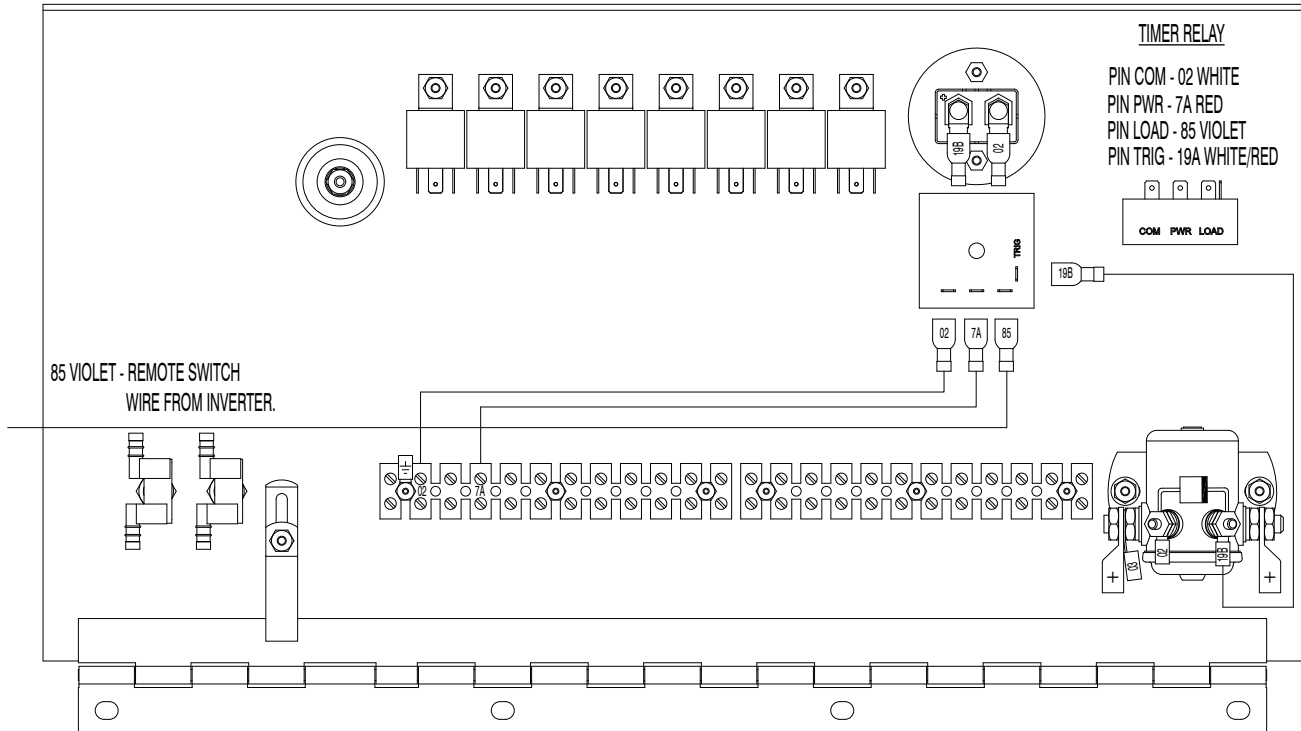

M155903AB\_S5 M132623AB

3.11 Disc Brake Kits and Torque Specifications

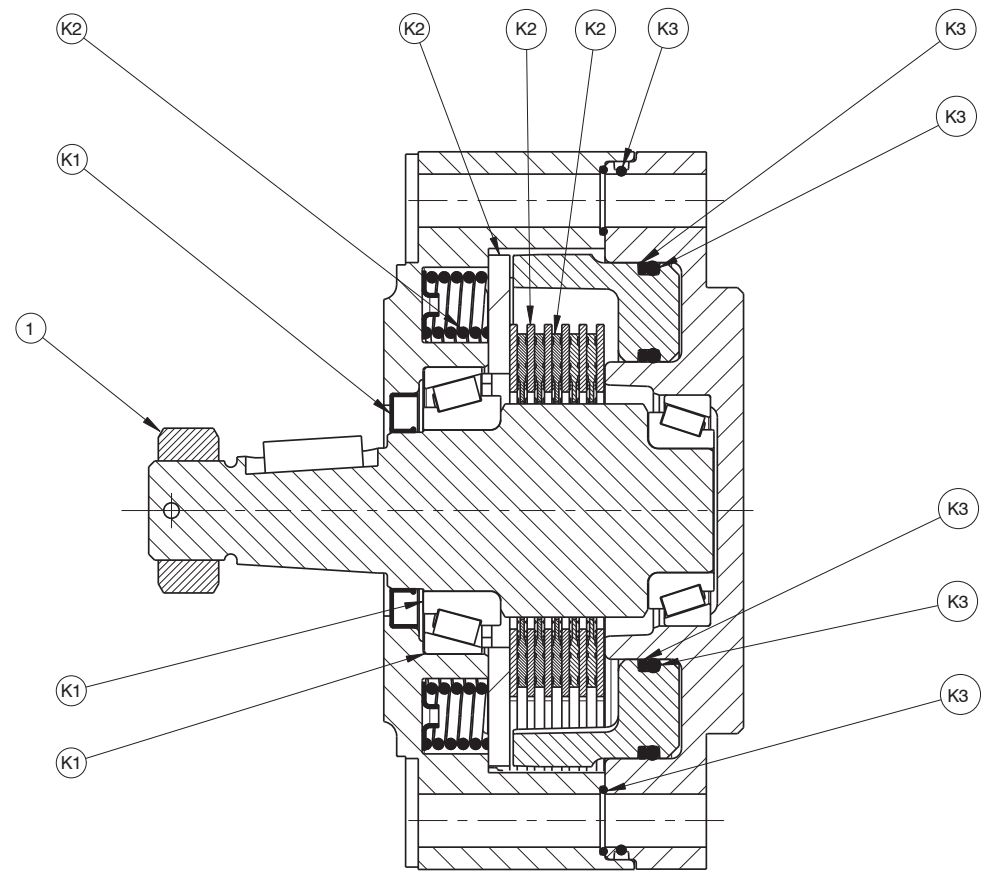

SECTION A-A

**BRAKE KITS**  
 K1 - KIT, BEARING AND SEAL  
 K2 - KIT, BRAKE STACK  
 K3 - KIT, O-RING

**TORQUE SPECIFICATIONS**  
 1 - TORQUE CASTLE NUT TO 237 Nm  
 2 - TORQUE BRAKE BOLTS TO 115 Nm  
 3 - TORQUE MOUNTING BOLTS TO 115 Nm

**OIL TYPE**  
 CATERPILLAR T0-4 SAE 30 HYDRAULIC OIL (200 mL)

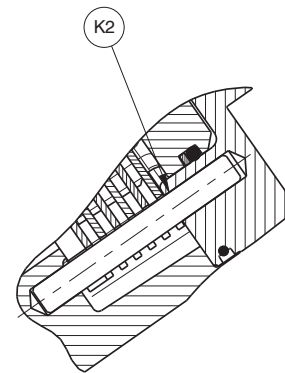
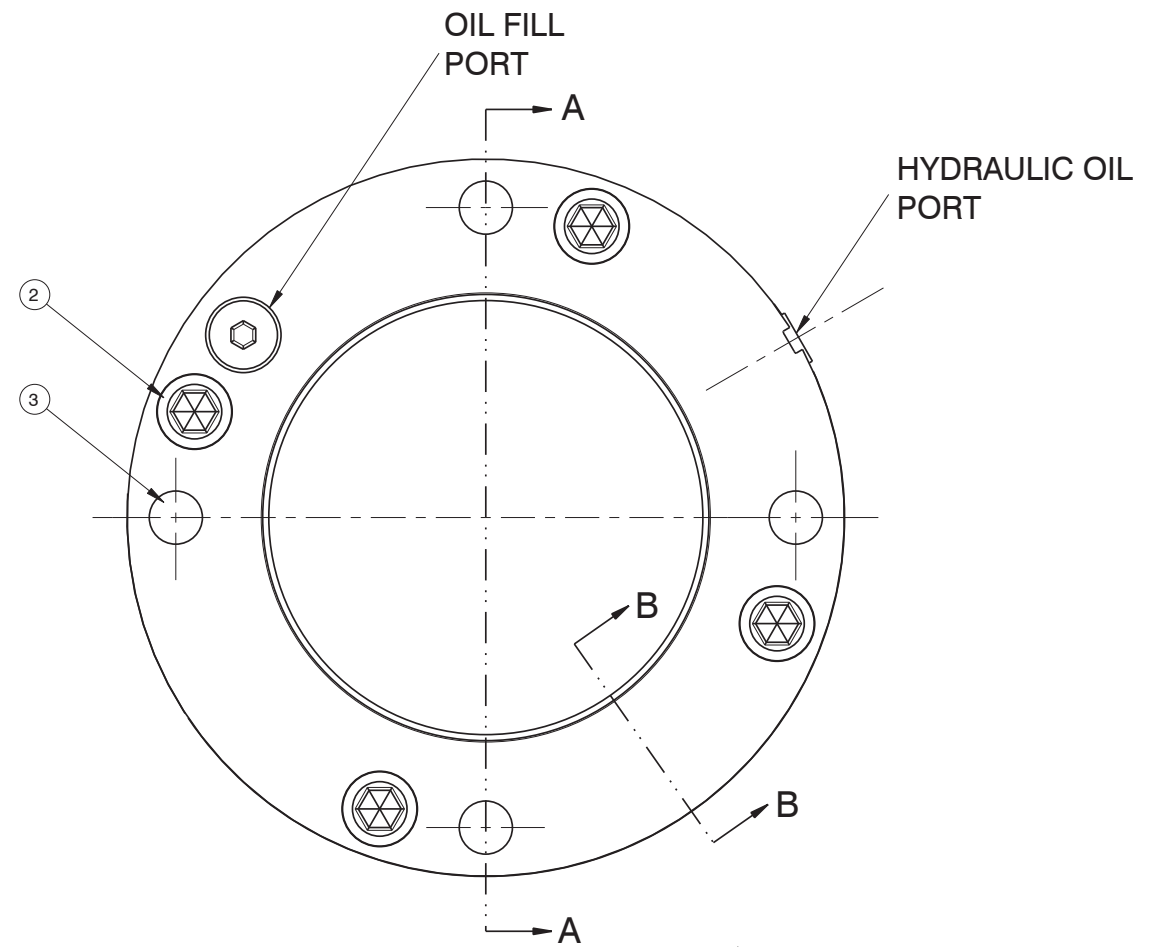

SECTION B-B

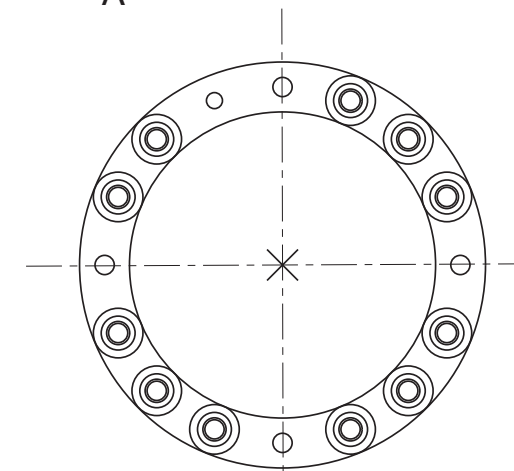

SPRING ARRANGEMENT

M154839AA\_S3

3.12 Hydraulic Schematic

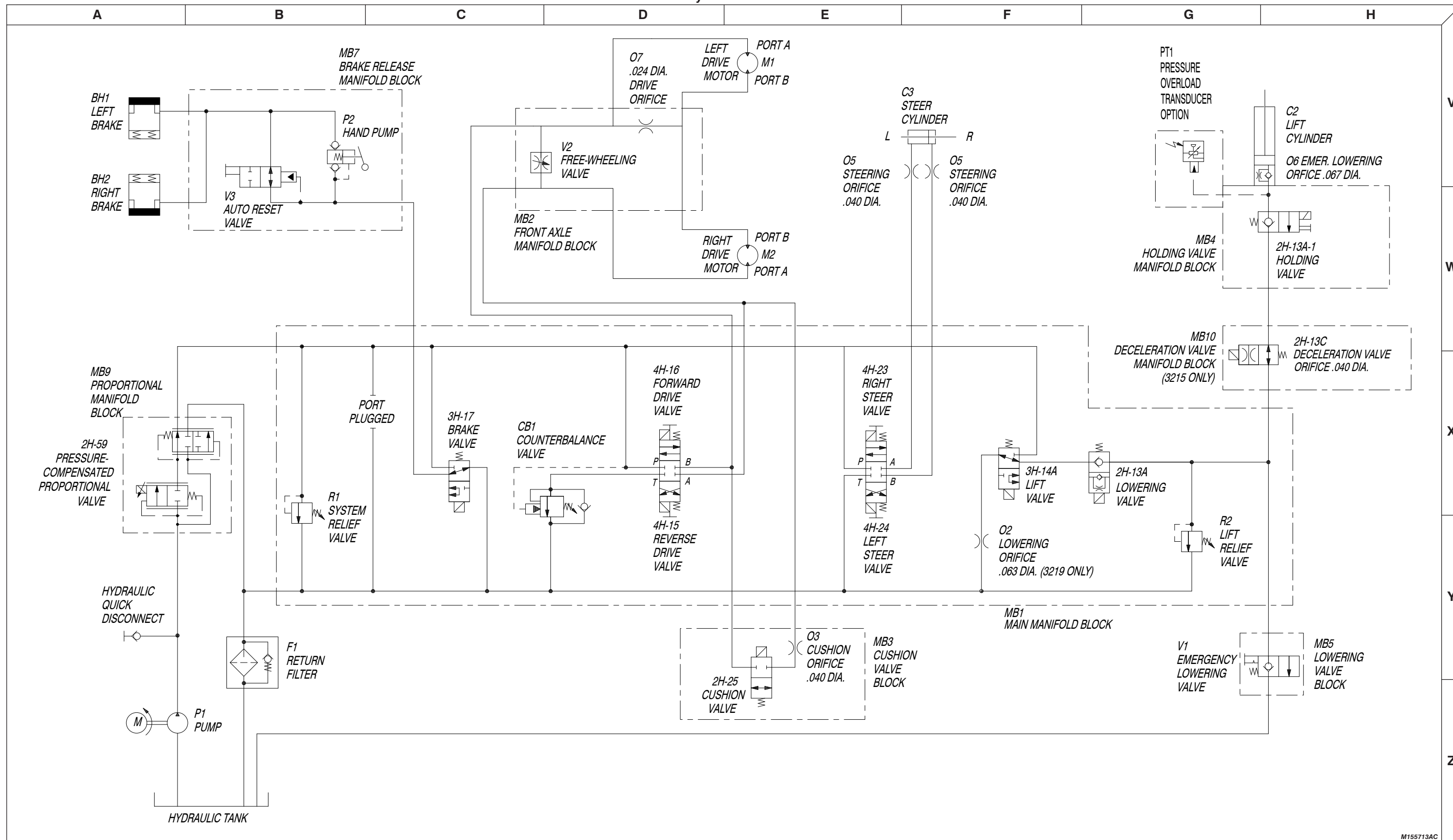

M155713AC

3.13 Main Manifold Harness and Holding Valve Harness

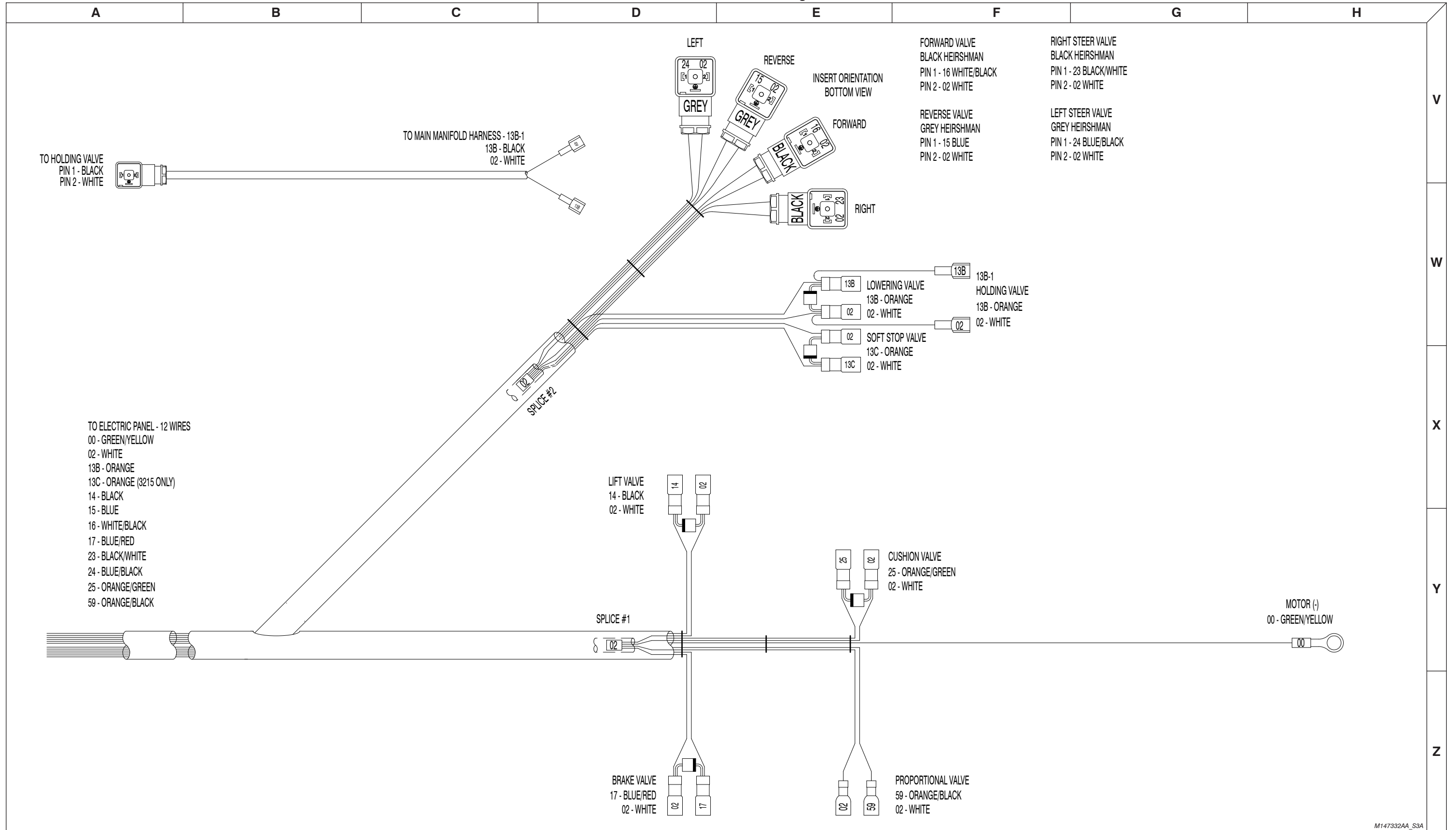

M147332AA\_S3A

### 3.14 Electrical Panel Diagram

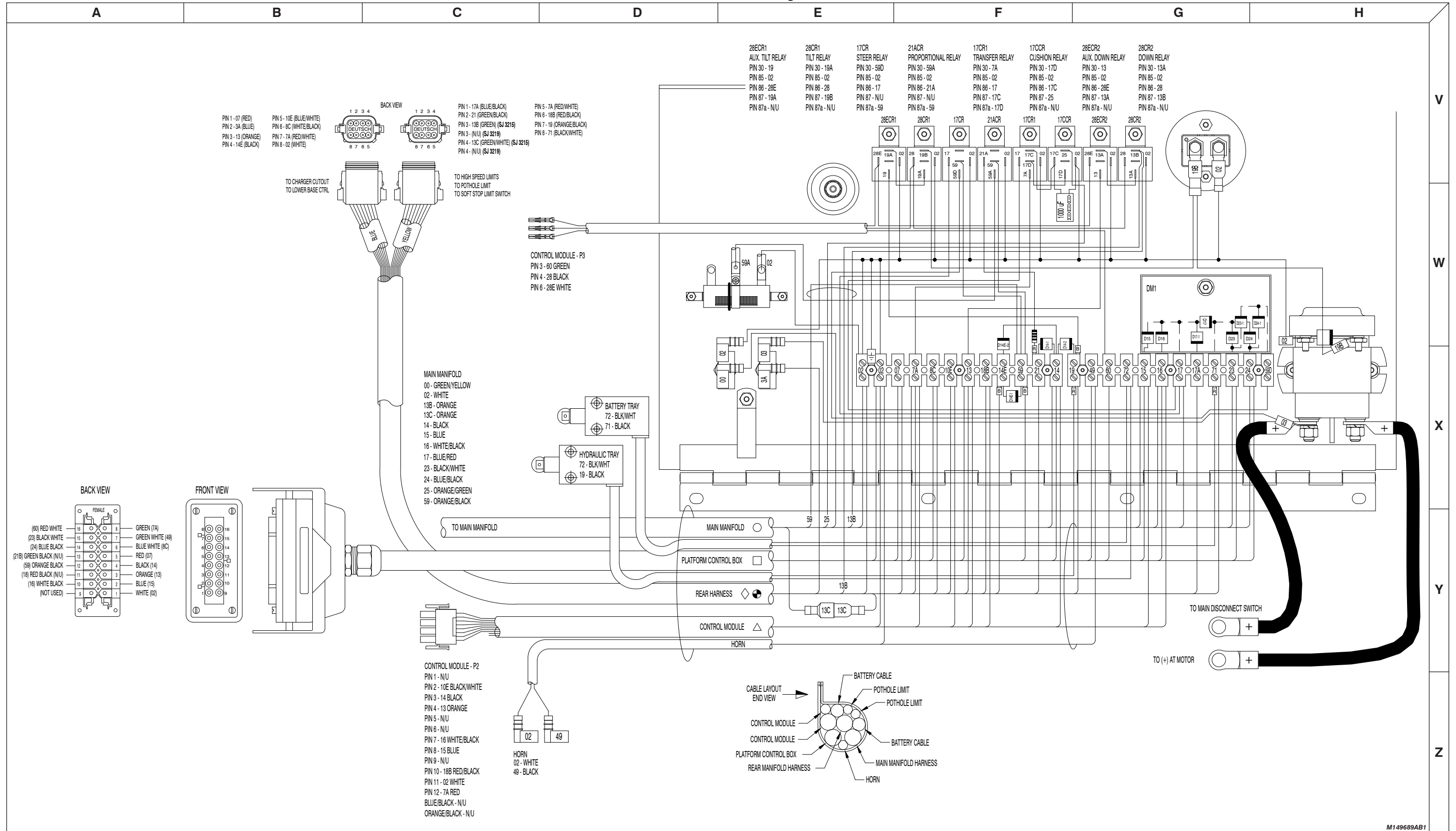

M149689AB1

3.15 Limit Switch Assemblies Diagram

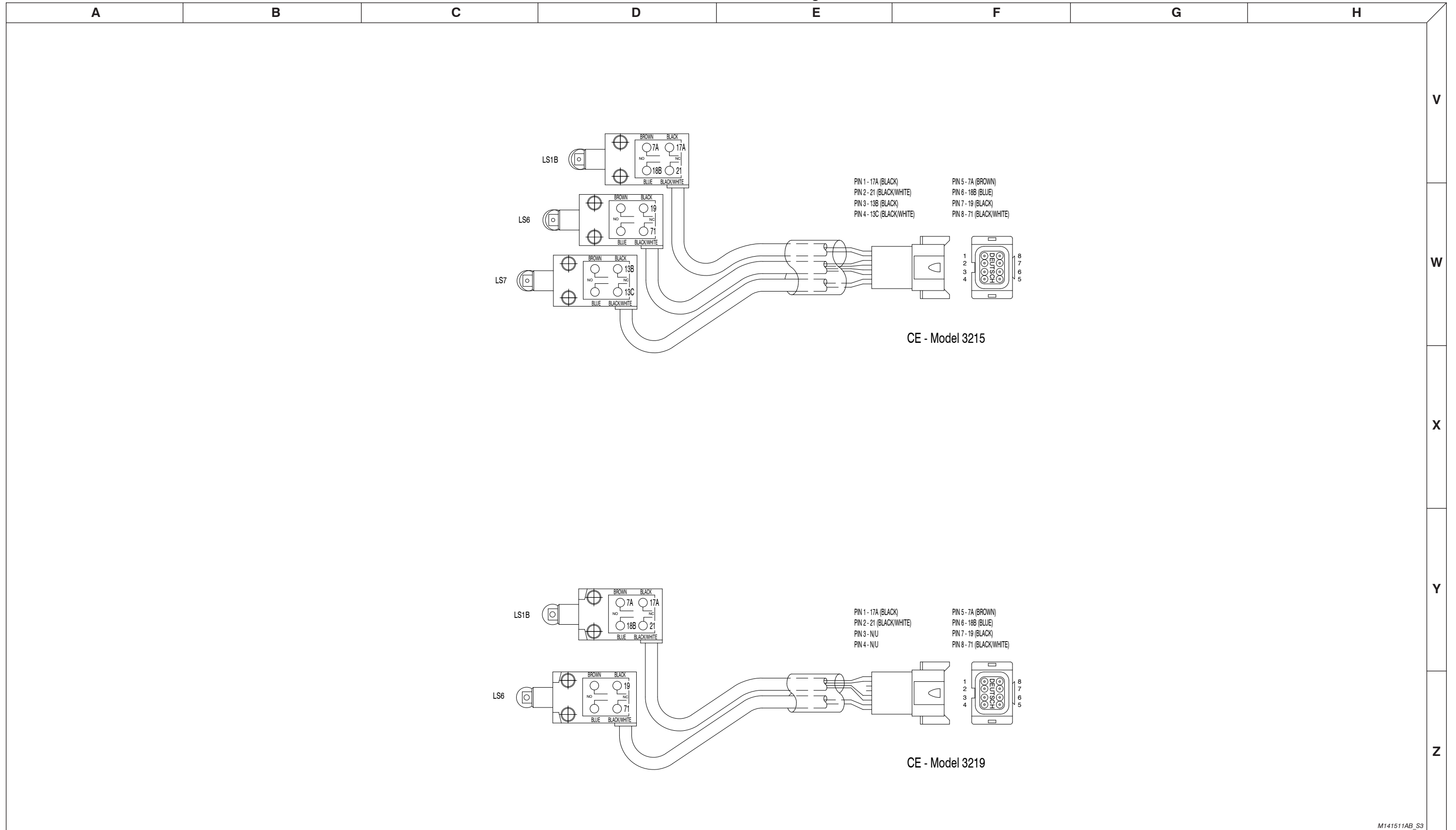

M141511AB\_S3

3.16 Control Module and Beeper Diagram

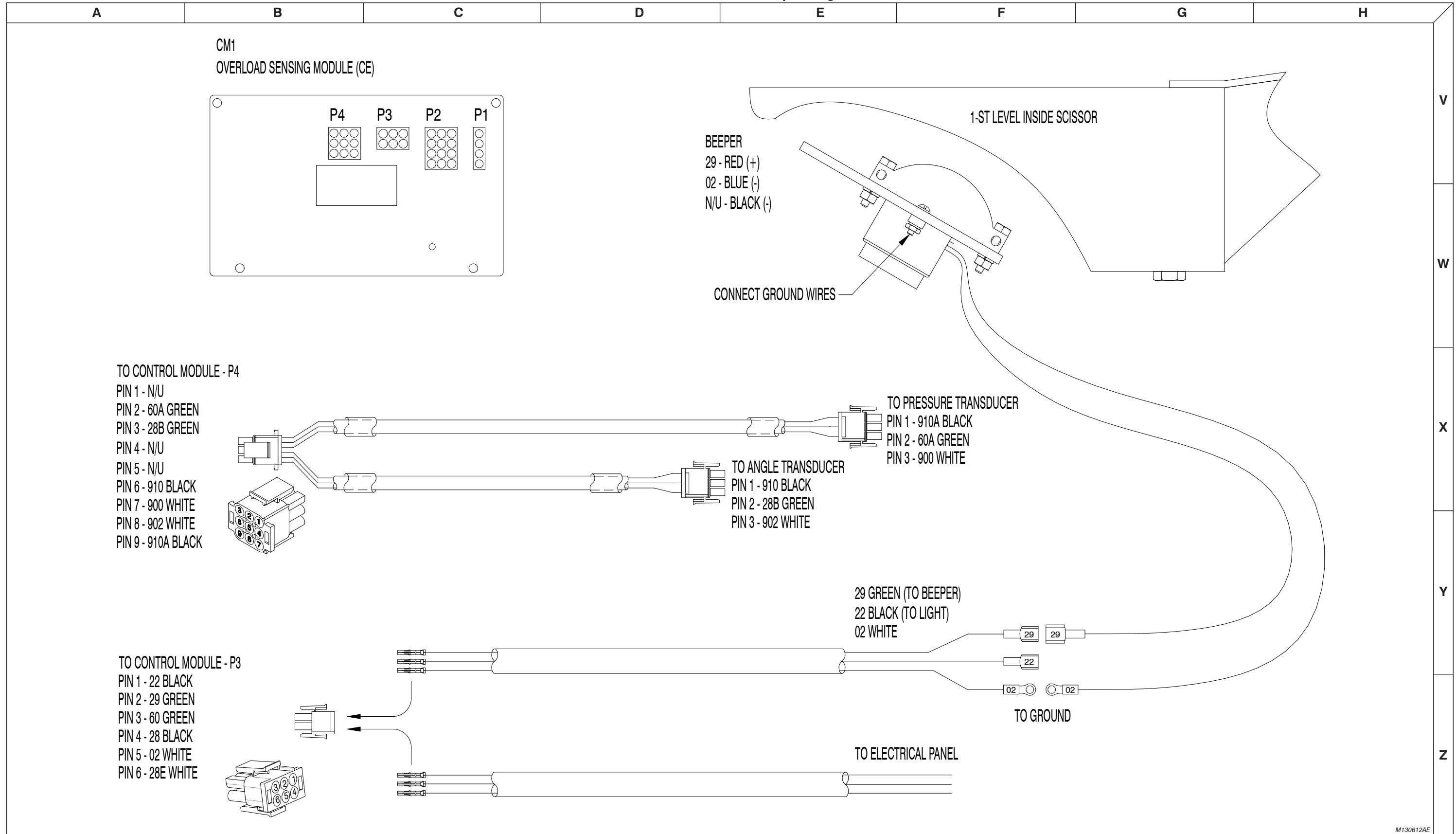

M130612AE



3.17a Electrical Schematic - Equipped with all options (Toggle Switch)

AB

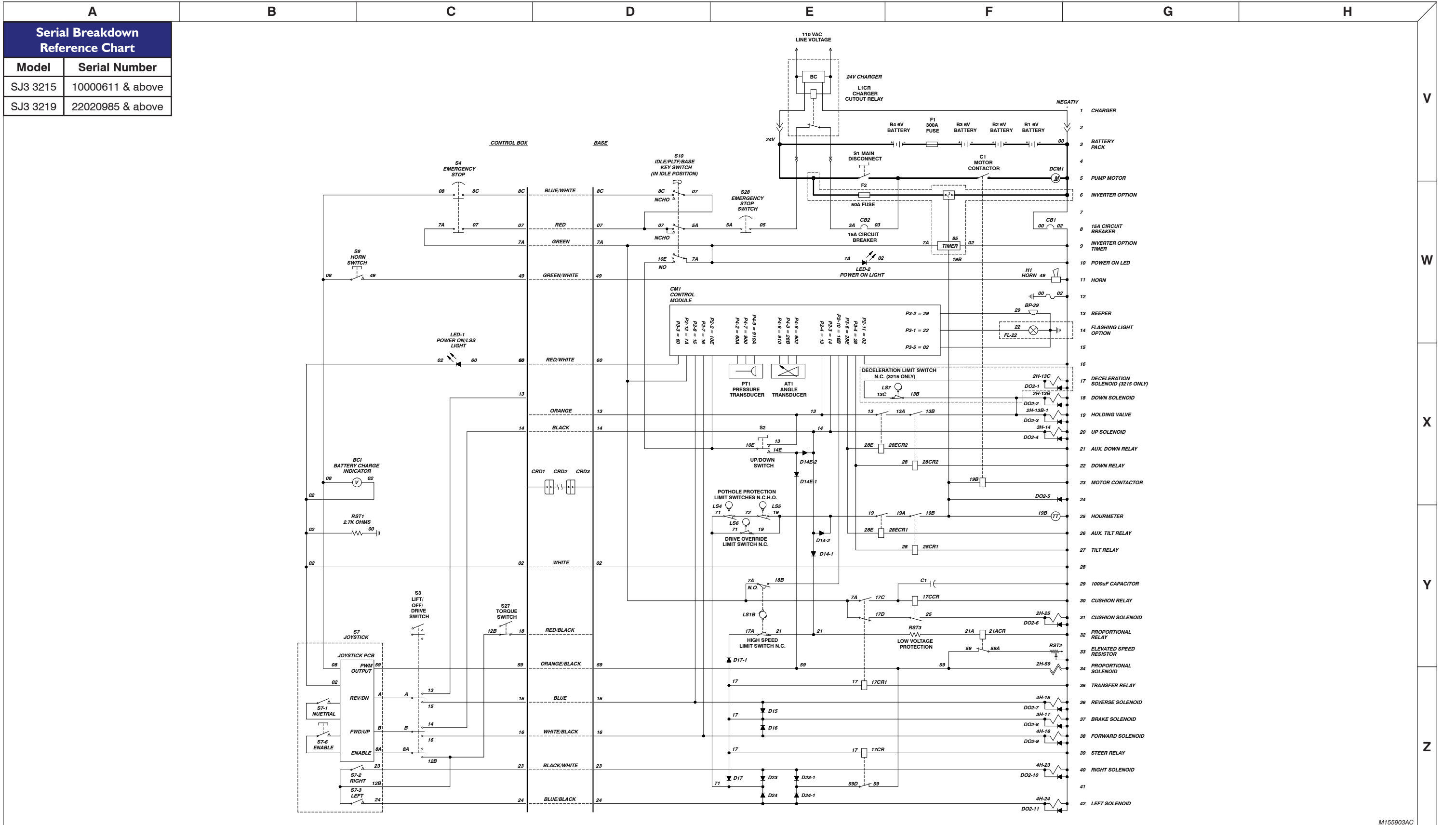

V

W

X

Y

Z

M155903AC

3.17b Electrical Schematic - Equipped with all options (Rotary Switch)

AB

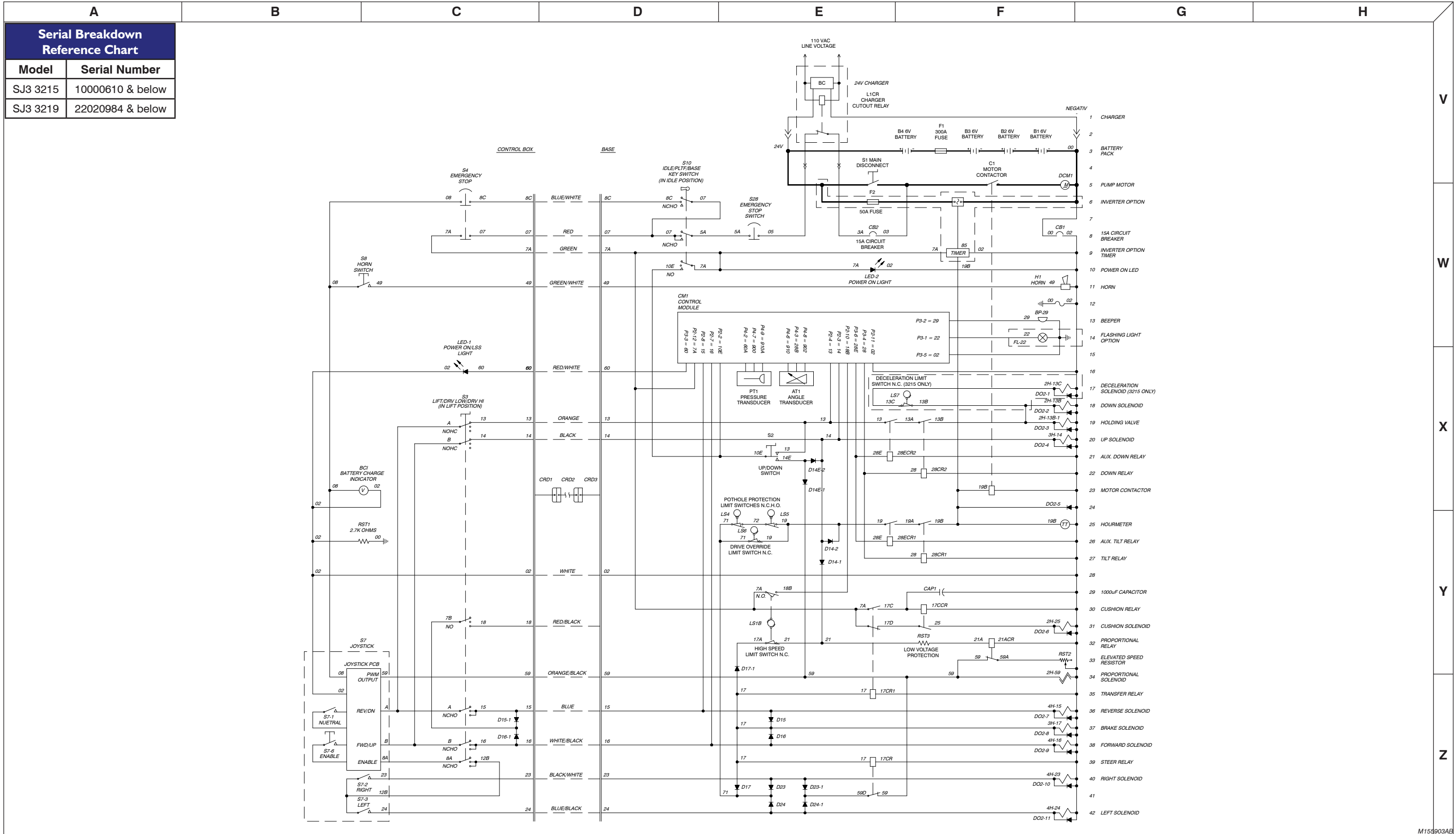

Serial Breakdown Reference Chart	
Model	Serial Number
SJ3 3215	10000610 & below
SJ3 3219	22020984 & below

V

W

X

Y

Z

M155903AB

---

## Section 4 TROUBLESHOOTING INFORMATION

### Table of Contents

Introduction .....	3
<b>Electrical System</b>	
4.1-1 All Controls Inoperative.....	4
4.1-2 All Controls Inoperative From Base Control Console .....	5
4.1-3 All Controls Inoperative From Platform Control Console .....	5
4.1-4 No Drive or Up Function from Platform Controls .....	5
4.1-5 No Down or Reverse Function from Platform Controls.....	6
4.1-6 No Up or Forward Only Function from Platform Control Console.....	6
4.1-7 No Up Function from Platform or Base Control Console.....	6
4.1-8 No Up Function from Base Control Console.....	7
4.1-9 No Down Function from Platform or Base Control Console .....	7
4.1-10 No Down Function from Base Control Console.....	7
4.1-11 Platform Lowers Slowly from Platform and Base (Model 3215) .....	7
4.1-12 Platform does not Decelerate when Lowering (Model 3215).....	8
4.1-13 Platform Lifts Slowly from Platform and Base Control console .....	8
4.1-14 Steer Only Inoperative .....	8
4.1-15 Drive Only Inoperative .....	8
4.1-16 No Drive or Steer when Platform Fully Lowered .....	8
4.1-17 No Drive or Steer when Platform Elevated.....	8
4.1-18 Elevated Drive Speed Does Not Activate .....	9
4.1-19 Platform Drives in Slow Speed Only.....	9
4.1-20 Forward Drive Function Inoperative .....	10
4.1-21 Reverse Drive Function Inoperative.....	10
4.1-22 Brake will not Release.....	10
4.1-23 Two or more Functions at one time .....	10
<b>Hydraulic System</b>	
4.2-1 All Functions Inoperative .....	11
4.2-2 All Functions Sluggish .....	11
4.2-3 Platform Drifts Down .....	11
4.2-4 Platform Lifts Slowly.....	11
4.2-5 Platform Does Not Lift.....	11
4.2-6 Platform will not Lower.....	12
4.2-7 Platform Lowers Slowly .....	12
4.2-8 Platform Drives Slow .....	12
4.2-9 Platform will not Drive in Forward or Reverse .....	12
4.2-10 Brake(s) will not Release .....	12
4.2-11 Brake(s) will hold machine on grade.....	12
4.2-12 Platform does not Steer Left .....	13
4.2-13 Platform does not Steer Right .....	13



## Introduction

The following pages contain a table of Troubleshooting Information for locating and correcting most service trouble which can develop. Careful and accurate analysis of the systems listed in the table of Troubleshooting Information will localize the trouble more quickly than any other method. This manual cannot cover all possible troubles and deficiencies that may occur. If a specific trouble is not listed, isolate the major component in which the trouble occurs, isolate whether the problem is electrical or hydraulic, and then isolate and correct the specific problem.

The content of this section is separated into “probable cause” and “remedy.” The information preceded by a number represents the “probable cause.” The following line, noted by a dash represents the “remedy” to the “probable cause” directly above it. See example below for clarification.

1. Probable Cause
  - Remedy

## Electrical System

### 4.1-1 All Controls Inoperative

1. Battery charger plugged into external power source.
  - Disconnect charger cord.
2. Batteries disconnected.
  - Connect batteries.
3. Dirty or loose battery terminals.
  - Clean and tighten connections.
4. Battery charge low.
  - Check each cell with a hydrometer. Reading should be 1.275 (fully charged). Recharge if low reading. Replace if reading difference between cells is 0.050.
5. Main battery cables open or defective.
  - Check continuity. Replace if defective.
6. Fuse F1 defective.
  - Replace fuse.
7. Main battery disconnect switch S1 open or defective.
  - Close switch. Check continuity. Replace if defective.
8. Loose or broken wire #3 from motor contactor C1 to circuit breaker CB2.
  - Check continuity. Replace if defective.
9. Defective or tripped circuit breaker CB2.
  - Reset circuit breaker. Replace if defective.
10. Loose or broken wire #3A from circuit breaker CB2 to charger relay L1CR.
  - Check continuity. Replace if defective.
11. Defective battery charger relay L1CR.
  - Check relay. Replace if defective.
12. Loose or broken wire #5 from charger relay L1CR to base emergency stop switch S28.
  - Check continuity. Replace if defective.
13. Open or defective base emergency stop switch S28.
  - Close switch. Check switch. Replace if defective.
14. Loose or broken wire #5A from base emergency stop switch S28 to base key switch S10.
  - Check continuity. Replace if defective.
15. Open or defective base key switch S10.
  - Select function with switch. Check switch. Replace if defective.
16. Loose or broken wire #07 from base key switch S10 to base terminal block.
  - Check continuity. Replace if defective.
17. Loose or broken wire #07 from base terminal block to platform emergency stop switch S4.
  - Check continuity. Replace if defective.
18. Open or defective platform emergency stop switch S4.
  - Close switch. Replace if defective.
19. Loose or broken wire #7A from platform emergency stop switch S4 to base terminal block.
  - Check continuity. Replace if defective.
20. Loose or broken wire #7A from base terminal block to base key switch S10.
  - Check continuity. Replace if defective.
21. Open or defective base key switch S10.
  - Close switch. Replace if defective.
21. Loose or broken wire #00 from pump motor DCM1 to circuit breaker CB1.
  - Check continuity. Replace if defective.
22. Defective or tripped circuit breaker CB1.
  - Reset circuit breaker. Replace if defective.
23. Loose or broken wire #02 from circuit breaker CB1 to base terminal block.
  - Check continuity. Replace if defective.

## Electrical System (Continued)

24. Loose or broken wire #7A from base terminal block to CM1 control module pin P2-12.
  - Check continuity. Replace if defective.
25. Loose or broken wire #02 from base terminal block to CM1 control module pin P2-11.
  - Check continuity. Replace if defective.
26. Loose or broken wire #28 from CM1 control module pin P3-4 to tilt relay 28CR1 and down relay 28CR2.
  - Check continuity. Replace if defective.
27. Loose or broken wire #28E from CM1 control module pin P3-6 to Aux. tilt relay 28ECR1 and Aux. down relay 28ECR2.
  - Check continuity. Replace if defective.

### 4.1-2 All Controls Inoperative From Base Control Console

1. Loose or broken wire #10E from base key switch S10 to base up/down switch S2.
  - Check continuity. Replace if defective.
2. Loose or broken wire #10E from base terminal block to CM1 control module pin P2-2.
  - Check continuity. Replace if defective.

### 4.1-3 All Controls Inoperative From Platform Control Console

1. Loose or broken wire #8C from base key switch S10 to base terminal block.
  - Check continuity. Replace if defective.
2. Loose or broken wire #8C or wire #02 from base terminal block to platform emergency stop switch S4.
  - Check continuity. Replace if defective.
3. Open or defective platform emergency stop switch S4.
  - Close switch. Replace if defective.
4. Loose or broken wire #8 or wire #02 from emergency stop switch S4 to battery charge indicator BCI.
  - Check continuity. Replace if defective.
5. Loose or broken wire #8 or wire #02 from battery charge indicator BC1 to joystick S7.
  - Check continuity. Replace if defective.
6. Defective joystick enable switch S7-6.
  - Check switch. Replace if defective.
7. Defective joystick neutral switch S7-1.
  - Check switch. Replace if defective.
8. Defective joystick S7.
  - Check joystick. Replace if defective.

### 4.1-4 No Drive or Up Function from Platform Controls

1. Defective tilt relay 28CR1 or Aux. tilt relay 28ECR1.
  - Check relay. Replace if defective.
2. Loose or broken wire #02 from base terminal block to tilt relay 28CR1 or Aux. tilt relay 28ECR1.
  - Check continuity. Replace if defective.
3. Loose or broken wire #28 from CM1 control module pin P3-4 to tilt relay 28CR1.
  - Check continuity. Replace if defective.
4. Loose or broken wire #28E from CM1 control module pin P3-6 to Aux. tilt relay 28ECR1.
  - Check continuity. Replace if defective.
5. Loose or broken wire #19 from base terminal block to Aux. tilt relay 28ECR1.
  - Check continuity. Replace if defective.
6. Loose or broken wire #19A from Aux. tilt relay 28ECR1 to tilt relay 28CR1.
  - Check continuity. Replace if defective.

## Electrical System (Continued)

7. Loose or broken wire #19B from tilt relay 28CR1 to hour meter.
  - Check continuity. Replace if defective.
8. Loose or broken wire #19B from hour meter to motor contactor C1.
  - Check continuity. Replace if defective.
9. Loose or broken wire #59 from proportional controller S7 to base terminal block.
  - Check continuity. Replace if defective.
10. Loose or broken wire #59 from base terminal block to proportional coil 2H-59.
  - Check continuity. Replace if defective.
11. Loose or broken wire #02 from base terminal block to proportional coil 2H-59.
  - Check continuity. Replace if defective.
12. Defective proportional coil 2H-59.
  - Check continuity through coil. Replace if defective.

### 4.1-5 No Down or Reverse Function from Platform Controls

1. Loose or broken wire "A" from proportional controller S7 to lift/drive switch S3.
  - Check continuity. Replace if defective.
2. Lift/Drive switch S3 defective.
  - Check switch. Replace if defective.
3. Defective PWM card on joystick S7.
  - Check joystick card. Replace if defective.
4. Loose or broken wire #13 down or #15 reverse from lift/drive switch S3 to base terminal block.
  - Check continuity. Replace if defective.

### 4.1-6 No Up or Forward Only Function from Platform Control Console

1. Loose or broken wire "B" from proportional controller S7 to lift/drive switch S3.
  - Check continuity. Replace if defective.
2. Lift/Drive switch S3 defective.
  - Check switch. Replace if defective.
3. Defective PWM card on joystick S7.
  - Check joystick card. Replace if defective.
4. Loose or broken wire #14 up or #16 forward from lift/drive switch S3 to base terminal block.
  - Check continuity. Replace if defective.

### 4.1-7 No Up Function from Platform or Base Control Console

1. Loose or broken wire #14 from base terminal block to up valve coil 3H-14.
  - Check continuity. Replace if defective.
2. Loose or broken wire #02 from base terminal block to up valve coil 3H-14.
  - Check continuity. Replace if defective.
3. Defective up valve coil 3H-14.
  - Check continuity through coil. Replace if defective.
4. Loose or broken wire #14 from base terminal block to CM1 control module pin P2-3.
  - Check continuity. Replace if defective.
5. Open diode D14-1.
  - Check diode. Replace if defective.
6. Open diode D14-2.
  - Check diode. Replace if defective.
7. Machine not level. (Above high speed limit switch)
  - Use on level surface.
8. See 4.1-6 platform controls or 4.1-8 base controls of this section for more troubleshooting information.

## Electrical System (Continued)

### 4.1-8 No Up Function from Base Control Console

1. Defective up/down switch S2.
  - Check switch. Replace if defective.
2. Loose or broken wire #14E from up/down switch S2 to base terminal block.
  - Check continuity. Replace if defective.
3. Open or defective diode D14E-1.
  - Check diode. Replace if defective.
4. Open or defective diode D14E-2.
  - Check diode. Replace if defective.

### 4.1-9 No Down Function from Platform or Base Control Console

#### **NOTE**

Down function is not proportionally controlled.

1. Loose or broken wire #13 from base terminal block to CM1 control module pin P2-4.
  - Check continuity. Replace if defective.
2. Defective down relay 28CR2 or Aux. down relay 28ECR2.
  - Check relay. Replace if defective.
3. Loose or broken wire #02 from base terminal block to down relay 28CR2 or Aux. down relay 28ECR2.
  - Check continuity. Replace if defective.
4. Loose or broken wire #13 from base terminal block to Aux. down relay 28ECR2.
  - Check continuity. Replace if defective.
5. Loose or broken wire #13A from Aux. down relay 28ECR2 to down relay 28CR2.
  - Check continuity. Replace if defective.
6. Loose or broken wire # 13B from down relay 28CR2 to down valve 2H-13B or holding valve 2H-13B-1.
  - Check continuity. Replace if defective.
7. Defective down valve coil 2H-13B.
  - Check continuity through coil. Replace if defective.
8. Defective lift cylinder holding valve coil 2H-13B-1.
  - Check continuity through coil. Replace if defective.
9. Loose or broken wire #02 from holding valve coil 2H-13B-1 or down valve coil 2H-13B to base terminal block.
  - Check continuity. Replace if defective.
10. See 4.1-5 platform controls or 4.1-10 base controls of this section for more troubleshooting information.

### 4.1-10 No Down Function from Base Control Console

1. Defective up/down switch S2.
  - Check switch. Replace if defective.
2. Loose or broken wire #13 from up/down switch S2 to base terminal block.
  - Check continuity. Replace if defective.

### 4.1-11 Platform Lowers Slowly from Platform and Base (Model 3215)

1. Deceleration limit switch LS7 stuck, out of adjustment or is defective.
  - Readjust limit switch so it returns to the normally closed position at 14" before completely stowed. Check the limit switch is functioning. Replace if defective.



## Electrical System (Continued)

### 4.1-12 Platform does not Decelerate when Lowering (Model 3215)

1. Deceleration limit switch LS7 out of adjustment.
  - Readjust limit switch so it returns to the normally closed position at 14" before completely stowed. Check the limit switch is functioning. Replace if defective.
2. Loose or broken wire #13C from terminal strip to deceleration valve coil 2H-13C.
  - Check continuity. Replace if defective.
3. Loose or broken wire #02 from terminal strip to deceleration valve coil 2H-13C.
  - Check continuity. Replace if defective.
4. Defective deceleration valve coil 2H-13C.
  - Check coil. Replace if defective.

### 4.1-13 Platform Lifts Slowly from Platform and Base Control console

1. Open diode D14-1.
  - Check diode. Replace if defective.

### 4.1-14 Steer Only Inoperative

1. Defective relay 17CR.
  - Check relay. Replace if defective.
2. No output to wire #59D (while operating a steer only function) from diode module DM1 at base terminal block TB1.
  - Check for 24 volts at #59D at terminal block. Replace diode module if no voltage found or is defective.
3. Loose or broken wire #59D from 17CR steer relay to base terminal block TB1.
  - Check continuity. Replace if defective.
4. Loose or broken wire #59 from 17CR steer relay to base terminal block TB1.
  - Check continuity. Replace if defective.

### 4.1-15 Drive Only Inoperative

1. No output to wire #71 (while operating a drive only function) from diode module DM1 at base terminal block TB1.
  - Check for 24 volts at #71 at terminal block. Replace diode module if no voltage found or is defective.

### 4.1-16 No Drive or Steer when Platform Fully Lowered

1. Loose or broken wire #71 from base terminal block to drive override limit switch LS6.
  - Check continuity. Replace if defective.
2. Defective drive override limit switch LS6.
  - Check switch. Replace if defective.
3. Loose or broken wire #19 from drive override limit switch LS6 to base terminal block.
  - Check continuity. Replace if defective.

### 4.1-17 No Drive or Steer when Platform Elevated

1. Pothole protection bars not fully lowered.
  - Clear obstructions. Repair as needed.
2. Loose or broken wire #71 from base terminal block to pothole protection limit switch LS4.
  - Check continuity. Replace if defective.
3. Defective pothole protection limit switch LS4.
  - Check switch. Replace if defective.
4. Loose or broken wire #72 from pothole protection limit switch LS4 to base terminal block.
  - Check continuity. Replace if defective.

## Electrical System (Continued)

5. Loose or broken wire #72 from base terminal block to pothole protection limit switch LS5.
  - Check continuity. Replace if defective.
6. Defective pothole protection limit switch LS5.
  - Check switch. Replace if defective.
7. Loose or broken wire #19 from pothole protection limit switch LS5 to base terminal block.
  - Check continuity. Replace if defective.

### 4.1-18 Elevated Drive Speed Does Not Activate

1. Loose or broken wire #59 from base terminal strip to proportional relay 21ACR.
  - Check continuity. Replace if defective.
2. Loose or broken wire #59A from proportional relay 21ACR to resistor RST2.
  - Check continuity. Replace if defective.

#### **NOTE**

The resistor on this machine is adjustable.

3. Resistor RST2 out of adjustment or open.
  - Check resistor ohms, it should read approx. 13 ohms. Refer to elevated drive speed set up in section 5.2-4 of this manual. Readjust as necessary or replace if defective.
4. Loose or broken wire #02 from resistor RST2 to base terminal block.
  - Check continuity. Replace if defective.
5. Proportional relay 21ACR defective.
  - Check relay, replace if defective.

### 4.1-19 Platform Drives in Slow Speed Only

1. No output to wire #17A (while operating a drive function) from diode module DM1 at base terminal block TB1.
  - Check for 24 volts at #17A at terminal block. Replace diode module if no voltage found or is defective.
2. Loose or broken wire #17A from base terminal block to high speed limit switch LS1B.
  - Check continuity. Replace if defective.
3. Open or defective high speed limit switch LS1B.
  - Check switch. Replace if defective.
4. Loose or broken wire #21 from high speed limit switch LS1B to low voltage protection resistor RST3.
  - Check continuity. Replace if defective.
5. Defective low voltage protection resistor RST3.
  - Check resistor. Replace if defective.
6. Loose or broken wire #21A from low voltage protection resistor RST3 to proportional relay 21ACR.
  - Check continuity. Replace if defective.
7. Proportional relay 21ACR defective.
  - Check relay, replace if defective.
8. Loose or broken wire #2 from proportional relay 21ACR to base terminal block.
  - Check continuity. Replace if defective.
9. Proportional controller S7 out of adjustment.
  - Adjust controller. Refer to Section 5, Joystick Adjusting Procedure.

## Electrical System (Continued)

### 4.1-20 Forward Drive Function Inoperative

1. Loose or broken wire #16 from lift/drive switch S3 to base terminal block.
  - Check continuity. Replace if defective.
2. Loose or broken wire #16 from base terminal block to CM1 control module pin P2-7.
  - Check continuity. Replace if defective.
3. Loose or broken wire #16 from base terminal block to forward drive valve coil 4H-16.
  - Check continuity. Replace if defective.
4. Forward drive valve coil 4H-16 defective.
  - Check continuity through coil. Replace if defective.
5. Loose or broken wire #02 from forward drive valve coil 4H-16 to base terminal block.
  - Check continuity. Replace if defective.
6. No output to wire #17 (while operating a forward drive function) from diode module DM1 at base terminal block TB1.
  - Check for 24 volts at #17 at terminal block. Replace diode module if no voltage found or is defective.

### 4.1-21 Reverse Drive Function Inoperative

1. Loose or broken wire #15 from lift/drive switch S3 to base terminal block.
  - Check continuity. Replace if defective.
2. Loose or broken wire #15 from base terminal block to CM1 control module pin P2-8.
  - Check continuity. Replace if defective.
3. Loose or broken wire #15 from base terminal block to reverse drive valve coil 4H-15.
  - Check continuity. Replace if defective.
4. Reverse drive valve coil 4H-15 defective.
  - Check continuity through coil. Replace if defective.
5. Loose or broken wire #02 from reverse drive valve coil 4H-15 to base terminal block.
  - Check continuity. Replace if defective.
6. No output to wire #17 (while operating a reverse drive function) from diode module DM1 at base terminal block TB1.
  - Check for 24 volts at #17 at terminal block. Replace diode module if no voltage found or is defective.

### 4.1-22 Brake will not Release

1. Loose or broken wire #17 from base terminal strip to brake coil 3H-17.
  - Check continuity. Replace if defective.
2. Brake valve coil 3H-17 defective.
  - Check continuity through coil. Replace if defective.
3. Loose or broken wire #02 from brake valve coil 3H-17 to base terminal block.
  - Check continuity. Replace if defective.

### 4.1-23 Two or more Functions at one time

1. Shorted diode.
  - Check continuity of all diodes. Replace if defective.

## Hydraulic System

### 4.2-1 All Functions Inoperative

1. Proportional valve 2H-59 defective or is sticking.
  - Check valve. Replace if defective.
2. Compensator portion of proportional valve defective or is sticking.
  - Check valve. Replace if defective.
3. Pump P1 defective.
  - Check pump. Replace if defective.

### 4.2-2 All Functions Sluggish

1. System relief valve R1 defective or not adjusted properly.
  - Adjust valve. Replace if defective.
2. Hydraulic pump P1 worn.
  - Check pump. Replace if defective.

### 4.2-3 Platform Drifts Down

1. Defective lift cylinder gland seal.
  - Check for hydraulic oil leaking from the gland seal. Rebuild cylinder. Replace if damaged.
2. Combination of: Defective holding valve 2H-13A-1 and either defective lowering valve 2H-13A or relief valve R2 or manual lowering valve V1.
  - Check valves. Replace if defective.
3. Defective o-ring between lift cylinder and holding valve manifold block or loose bolts holding the manifold.
  - Check for hydraulic oil leaking from between cylinder and manifold. Tighten bolts on manifold or replace o-ring. Replace manifold if damaged.

### 4.2-4 Platform Lifts Slowly

1. Open or leaking manual lowering valve V1.
  - Close valve. Replace if defective.
2. Lift relief valve R2 defective or not adjusted correctly.
  - Adjust valve. Replace if defective.
3. Open manual override on holding valve 2H-13A-1.
  - Depress and turn manual override clockwise to close. Replace if defective.
4. Stuck or defective deceleration valve 2H-13C. **(Model 3215)**
  - Check valve. Replace if defective.
5. Stuck or defective emergency lowering orifice O6.
  - Check orifice. Replace if defective.

### 4.2-5 Platform Does Not Lift

1. Open manual lowering valve V1.
  - Close valve. Replace if defective.
2. Hydraulic oil level too low.
  - Fully lower the platform. Fill hydraulic tank with recommended fluid to appropriate level.
3. Platform weight excessive.
  - Reduce platform load to maximum capacity.
4. Up valve 3H-14 defective or is sticking.
  - Check valve. Replace if defective.
5. Plugged deceleration valve 2H-13C. **(Model 3215)**
  - Clear obstruction from valve. Replace if defective.

## Hydraulic System (Continued)

### 4.2-6 Platform will not Lower

**NOTE**

Down function is not proportionally controlled.

1. Lowering valve 2H-13A defective or is sticking.
  - Clean valve. Replace if defective.
2. Defective holding valve 2H-13A-1.
  - Clean valve. Replace if defective.
3. Lowering orifice O2 (3219 only) plugged or contaminated.
  - Clear debris. Replace Orifice. Replace if defective.
4. Emergency lowering orifice O6 plugged or contaminated.
  - Clear debris. Replace Orifice. Replace if defective.
5. Plugged deceleration valve 2H-13C.
  - Clear obstruction from valve. Replace if defective.

### 4.2-7 Platform Lowers Slowly

1. Stuck or defective deceleration valve 2H-13C.
  - Check valve. Replace if defective.

### 4.2-8 Platform Drives Slow

1. Free-wheeling valve V2 open or defective.
  - Close valve. Replace if defective.
2. Drive orifice O7 loose or missing.
  - Check for orifice. Reinstall.
3. Drive motor M1 or M2 defective.
  - Check motors. Replace if defective.
4. Cushion valve 2H-25 is stuck or defective.
  - Check valve. Replace if defective.

### 4.2-9 Platform will not Drive in Forward or Reverse

1. Open free-wheeling valve V2.
  - Close Valve. Replace if defective.
2. Forward drive valve 4H-16 or reverse drive valve 4H-15 defective or is sticking.
  - Clean Valve. Replace if defective.
3. Counterbalance valve CB1 defective or is plugged.
  - Clean Valve. Replace if defective.

### 4.2-10 Brake(s) will not Release

1. Brake valve 3H-17 defective or is sticking.
  - Clean valve. Replace if defective.

### 4.2-11 Brake(s) will hold machine on grade

1. Brake valve 3H-17 defective or is sticking.
  - Clean valve. Replace if defective.
2. Auto reset valve V3 defective or is sticking.
  - Clean valve. Replace if defective.
3. Brake Hubs defective.
  - Rebuild hubs. Replace if damaged.

## Hydraulic System (Continued)

### 4.2-12 Platform does not Steer Left

1. Left steer valve 4H-24 defective or sticking.
  - Clean valve. Replace if defective.
2. Steer cylinder C3 seals leaking.
  - Rebuild cylinder(s). Replace if damaged.
3. Mechanical binding in king pins.
  - Check for binding. Repair as needed.
4. Orifices 05 plugged.
  - Clean Orifices, and reinstall.

### 4.2-13 Platform does not Steer Right

1. Right steer valve 4H-23 defective or sticking.
  - Clean valve. Replace if defective.
2. Steer cylinder C3 seals leaking.
  - Rebuild cylinder(s). Replace if damaged.
3. Mechanical binding in king pins.
  - Check for binding. Repair as needed.
4. Orifices 05 plugged.
  - Clean Orifices, and reinstall.

---

## **Section 5 PROCEDURES**

### **Table of Contents**

#### **Service and Maintenance**

General.....	3
Safety and Workmanship.....	3

#### **Platform**

5.1-1 OEM Controller Electronics Information .....	3
5.1-2 OEM Controller Troubleshooting .....	4
5.1-3 OEM Controller switch wiring.....	5

#### **Base**

5.2-1 System Relief Pressure Adjustment.....	6
5.2-2 Lift Pressure Adjustment .....	6
5.2-3 Elevated Drive Speed Setup .....	7
Elevated Drive Speed Adjustment .....	7

#### **Load Sensing System**

5.3-1 Control Module Pin Reference Chart.....	8
5.3-2 LED Error Codes - Quick Reference Chart .....	9
5.3-3 LED Error Codes - Code Breakdown Chart.....	10
5.3-4 Hand Held Calibration/Diagnostic Tool Key Functions.....	12
5.3-5 Control Module Load Calibration - Code Messages & Definitions.....	13
5.3-6 Control Module Load Calibration Procedure.....	17
5.3-7 Curve/Group Codes Chart .....	21



## General

The following information is provided to assist you in the use and application of servicing and maintenance procedures contained in this chapter.

## Safety and Workmanship

Your safety, and that of others, is the first consideration when engaging in the maintenance of equipment. Always be conscious of weight. Never attempt to move heavy parts without the aid of a mechanical device. Do not allow heavy objects to rest in an unstable position. When raising a portion of the equipment, ensure that adequate support is provided.

## Platform

### 5.1-1 OEM Controller Electronics Information

#### Flow Control

Single coil or solenoid for single direction. The coil has two connections; one is wired to the P.C. Board (A) terminal and the other is wired to (-), or the negative side of the supply voltage. Switches to control directional valves may be provided on the controller.

#### Adjustment Procedures

Adjustments are made by turning a trimpot adjustment screw. The trimpots are multi-turn, end to end-devices. It may be necessary to turn the adjustment screw several turns to observe a change in output.

Clockwise (CW) adjustment of the trimpot increases the output.

Counter-clockwise (CCW) adjustment of the trimpot decreases the output.

Adjustments affect output current, voltage or percentage of duty cycle to the coil. The minimum and maximum output is preset at the factory. However, for optimum performance, they must be adjusted while the equipment is operating.

Although the following adjustments affect the current/voltage or percentage of duty cycle, the best way to adjust the function is to observe the response or speed of the function. The following adjustments affect function response, or speed. There may be some interaction between adjustments, making it necessary to repeat the adjustment in order to achieve the desired response.

#### “Threshold” Adjustments

Adjusts the initial current flow or duty cycle, affecting the function response or speed when the handle is first moved from the off position. Deflect the handle slowly to the position where the controller first turns on. Adjust the threshold trimpot screw to the point where the controlled function just starts to move, then turn the trimpot screw one, full turn in the counterclockwise direction. This adjustment should be done first.

#### “Maxout” Adjustments

Adjusts the full stroke current or duty cycle affecting the maximum function response, or speed when the handle is deflected to its full travel. Fully deflect the handle, and adjust the maxout trimpot for maximum desired function response or speed. To obtain proportional resolution, it is important that the function starts to slow down as soon as the handle is moved back from the fully deflected position.

The ideal adjustment occurs when the function just begins to move when the handle is deflected, and the output increases until it reaches its maximum desired response or speed at the end of handle travel.



### 5.1-2 OEM Controller Troubleshooting

#### Problem

1. The function will not operate when the handle is moved. The LEDs do not light
  - A. Check that voltage is present at the positive (+) input terminal.
  - B. Check that ground is connected to the negative (-) terminal.
  - C. If there is an in-line fuse, check to see if it is good.
  - D. Check the controller on/off switch and the connectors. Voltage should be present at the (X) terminal when the controller is turned on.
  - E. Check that valve wiring is not shorted to ground. The LEDs will not light.
  - F. Check that valve wiring is not open. The LEDs will light, but the intensity will not vary.
  - G. Check trimpot settings. Fully "CCW" turns output off, "CW" turns output fully on.
2. The function jumps or lurches when turned on.
  - A. Perform "Threshold" adjustment procedures.
3. The function reaches maximum speed before the handle is fully deflected,
  - A. Perform "Maxout" adjustment procedures.
4. The function speed remains constant regardless of the degree of handle deflection.
  - A. Perform "Maxout" adjustment procedures.

#### IRS Option

1. Function speed reacts too slowly or too quickly in relation to handle deflection.
  - A. Check "IRS" (Ramp) trimpot adjustment. "CW" increases ramp time, "CCW" decreases ramp time.

#### Integrated Ramp System (IRS)

Provides smooth function response ,when reacting to an abrupt change in handle deflection. "CW" rotation of the trimpot increases ramp time and slows the response time. "CCW" decreases ramp time and increases the response time. To increase the ramp time, turn the adjusting screw "CW" a few turns, then move the controller handle abruptly. Continue to adjust until a smooth response is observed. Most controllers have on/off contacts which remove power from the P.C. Board when the handle is returned to the off position. When the handle is abruptly returned to neutral, the output will not ramp down, and the function will stop.

#### Ramp Thru Off

The P.C. Board should be adjusted as outlined in the IRS adjustment procedure. If the handle is abruptly returned to neutral (OFF) the output will ramp down to off. Ramp time is factory set to 2 seconds, unless otherwise specified.

#### NOTE

Trimpots should be sealed with nail polish or enamel based paint.



#### WARNING

Do not use RTV silicone.

5.1-3 OEM Controller switch wiring

WIRE CHART		
COLOR	FROM	TO
WHT/RED	STEER LEFT	PIN #1
WHT/GRN	STEER COMMON	PIN #2
WHT	STEER RIGHT	PIN #3
YEL	FORWARD/UP	PIN #4
WHT/BLK	+24V INPUT	PIN #5
GRY	REVERSE/DOWN	PIN #6
BLU	PWM OUT (A)	PIN #7
BLK	GROUND (-)	PIN #8
WHT/BLU	ENABLE OUT	PIN #9

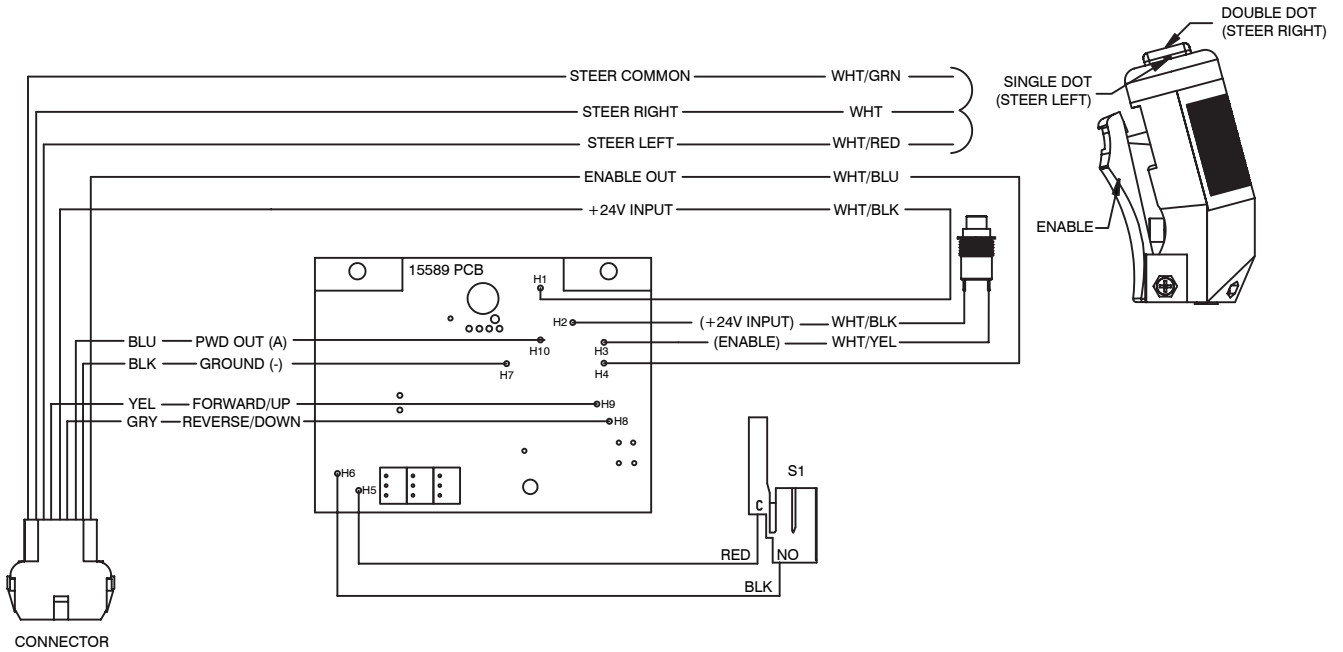

**Base****5.2-1 System Relief Pressure Adjustment**

1. Locate the system pressure quick disconnect port on the main manifold.
2. Install a calibrated 5000 psi gauge to the system pressure quick disconnect port.
3. Remove the platform control console the guardrail and disconnect from the main control cable.
4. Locate the main control cable plug at the rear of the aerial platform.
5. Disconnect the main cable and connect the platform control console into the plug.
6. At the main manifold, loosen the locknut on the system relief valve R1.
7. Select drive with the lift/drive select switch on the platform control console.
8. Engaged steer right and hold.
9. Observe reading on gauge. Adjust the R1 system relief valve listed on the serial number plate. Turning the stem on the relief valve clockwise will increases pressure. Turning the stem counterclockwise will decreases pressure.
10. Release steer switch and tighten the locknut.
11. Remove the gauge from system pressure test port.

**5.2-2 Lift Pressure Adjustment****NOTE**

Adequate area to raise the platform to full height is required for the following steps.

1. Locate the lift pressure test port on the main manifold.
2. Install a calibrated 5000 psi gauge to the lift pressure quick disconnect port.
3. At the main manifold, loosen the locknut on the lift relief valve R2.
4. Close the manual lowering valve. Use the lift switch at the base control console to raise the platform to full height and hold the lift up switch on.
5. Observe the reading on the gauge. Adjust the R2 relief valve to the value listed on the serial number plate. Turning the stem of the relief valve clockwise will increases pressure. Turning the stem counterclockwise will decreases pressure.
6. Remove the gauge from lift pressure test port.

**NOTE**

Pressure setting may vary as aerial platform components wear. The lift pressure should be set for rated load only.

5.2-3 Elevated Drive Speed Setup

**NOTE**

Elevated drive speed will need to be set if the adjustable resistor or proportional valve coil have been replaced.

1. Install the new components.
2. Use a multi-meter to measure resistance of the variable resistor (approximately 13 Ohms).

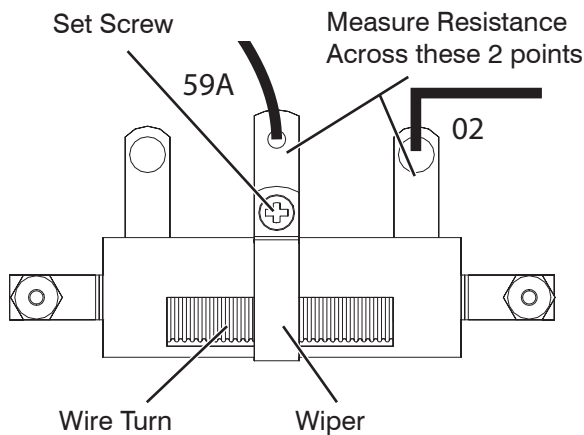

**NOTE**

Each wire turn on the resistor is approximately 0.5 Ohms.

3. If adjustment is needed, loosen the set screw on the slide wiper and move the wiper to the left to increase the resistance or to the right to reduce the resistance.

**Elevated Drive Speed Adjustment**

1. Lay out a 3.048 meter (10') long drive area on the floor with a start and finish line.
2. Elevate the platform to enable high speed cutout limit switch.

**NOTE**

Aerial work platform must be at full elevated drive speed before crossing the start line.

3. Drive the aerial work platform at full stroke of the joystick across the 3.048 meter (10') test area and measure drive time.

Acceptable Range		
Limit	Time (s)	Speed (m/s)
Maximum	10.03	0.30
Minimum	13.64	0.22

**NOTE**

Each wire turn on the resistor is approximately 0.6 seconds.

4. To adjust the speed (to achieve midpoint between maximum and minimum speed), loosen the set screw on the slide wiper and move the wiper to the left to increase the speed or to the right to reduce the speed.
5. Once the speed is in range, tighten and apply loctite 222MS to the set screw.
6. Tie a tie-wrap to the left of the slide wiper on the resistor.

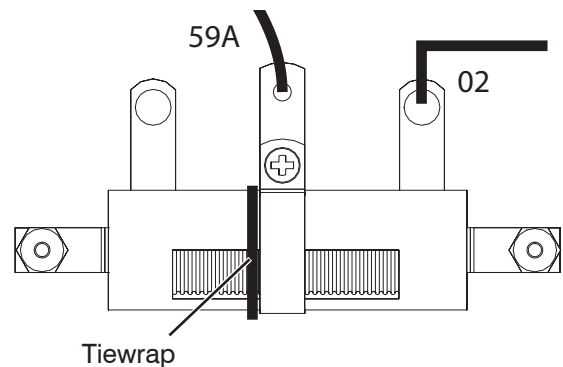

Load Sensing System

5.3-1 Control Module Pin Reference Chart

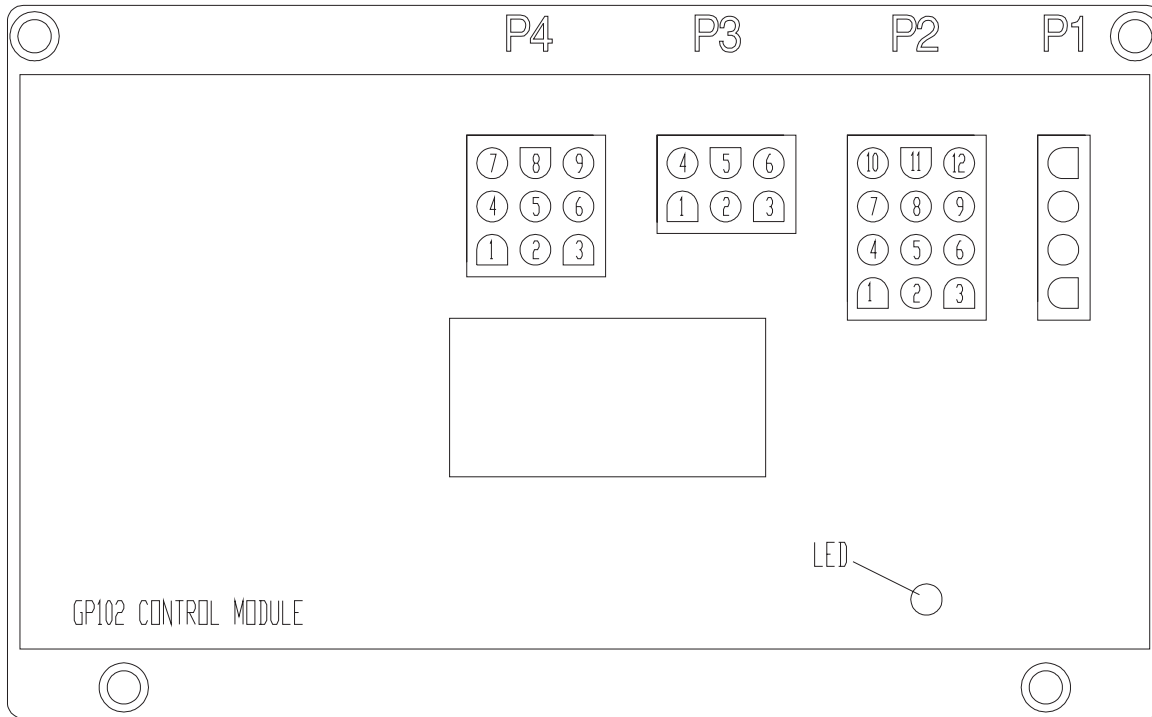

PLUG	PIN #	WIRE # AND COLOUR	WIRE FUNCTION
P1			The Calibration Connection
P2	1	Not Used	Not Used
P2	2	10E Black/White	Input Power From Base Terminal Strip To Confirm Lower Control Is Selected
P2	3	14 Black	Raise Platform Input
P2	4	13 Orange	Lower Platform Input
P2	5	Not Used	Not Used
P2	6	Not Used	Not Used
P2	7	16 White/Black	Forward Direction Input
P2	8	15 Blue	Reverse Direction Input
P2	9	Not Used	Not Used
P2	10	18B Red/Black	Input From LS1 High Speed Limit Switch To Verify ON/OFF Limits
P2	11	02 White	Negative Input From Base Terminal Strip
P2	12	7A Red	Main Power Input From Base Terminal Strip
P3	1	22 Red	Output To FL-22 Flashing Light
P3	2	29 Black	Output To BP-29 Beeper
P3	3	60 Black/White	Output To Overload Warning Light On Control Box
P3	4	28 Green/Black	Output To 28CR1 Tilt Relay And 28CR2 Down Relay
P3	5	02 White	Negative for Flashing Light and Beeper
P3	6	28E Green/White	Output To 28ECR1 Aux. Tilt Relay And 28ECR2 Aux. Down Relay
P4	1	Not Used	Not Used
P4	2	60A Green	Varied Input From Transducer
P4	3	28B Green	Varied Input From Angle Transducer
P4	4	Not Used	Not Used
P4	5	Not Used	Not Used
P4	6	910 Black	Positive Signal To Angle Transducer
P4	7	900 White	Negative Signal To Pressure Transducer
P4	8	902 White	Negative Signal To Angle Transducer
P4	9	910A Black	Positive Signal To Pressure Transducer

60303AH

## 5.3-2 LED Error Codes - Quick Reference Chart

HELP Message	LED indication
EVERYTHING OK	Steady on
IN GROUND MODE!	Steady on
OVERLOAD FUNCTIONS DISABLED!	6/6
VEHICLE TILTED	1/1
VEHICLE OVERLOADED	1/2
WAITING FOR B+ ON P2-12	5/2
ARMGUARD ACTIVE!	1/3
TOO HIGH - DRIVE PREVENTED	1/4
TOO HIGH - LIFT UP PREVENTED	1/5
TESTING HWFS	7/8
IDLE TIMEOUT ACTIVE!	Always off
WAITING FOR NEUTRAL	5/5
ARMGUARD ACTIVE!	2/3
ELEVATION SWITCH SHIFTED?	2/1
ELEVATION SWITCH STUCK?	2/2
NO LAST CALDATE!	6/3
LOAD NOT CALIBRATED	6/2
DRIVE/LIFT INPUTS FAULTY!	5/6
UP/DOWN SELECT INPUTS ACTIVE TOGETHER	5/4
INVALID LOAD - CHECK SENSORS	6/4
HEIGHT NOT CALIBRATED	6/1
INVALID HEIGHT - CHECK SENSOR	6/5
EMS INPUTS FAULTY!	5/2
B+ SUPPLY TOO LOW	5/1
P4-1 OR P5-1 SHORT TO 0V?	4/1
P3-4 SHORT TO SUPPLY!	4/2
P3-4 SHORT TO 0V?	4/3
P3-4 SHORT TO SUPPLY?	4/4
P3-6 SHORT TO 0V?	4/5
P3-6 SHORT TO SUPPLY?	4/6
FAULT: BAD TILT SENSOR	7/1
FAULT: BAD HWFS	7/2
FAULT: BAD SLAVE ANALOGS	7/3
FAULT: BAD STRAIN MONITORS	7/4
FAULT: BAD SLAVE MICRO	7/5
FAULT: HWFS STALLED!	7/6
STARTUP!	7/7
FACTORY OVERRIDE	6/7

60405AB

**Reading the Codes:**

In order to read the fault codes, a sequence of pauses and flashes can be seen on the LED mounted on the GP102 module. The codes are continuously displayed by the LED until the fault is cleared, the GP102 reset and no longer detects the fault, or idle timeout becomes active.

The sequence is as follows:

1. Quarter second flashes followed by quarter second pauses indicate the first digit.
2. A 1.5 second pause.
3. Quarter second flashes followed by quarter second pauses indicate the second digit
4. A 4 second pause. Repeat steps 1-4

Since the GP102 only reports one error, only one code can be read from the LED per instance. If the error is cleared and another error is present, it will then be presented.

### 5.3-3 LED Error Codes - Code Breakdown Chart

#### Diagnostic sequence dependant on LED flash code:

No Last Caldate	63
Load Not Calibrated	62
Height Not Calibration	61

An EZcal is required!

Waiting For Neutral	55
Drive/Lift Inputs Faulty!	56
Up/Down Select Inputs Active Together	54
EMS Inputs Faulty!	52

Check inputs on P2 pins 1,2,3,4,5,6,7,8.

P3-4 Short To Supply!	42
P3-4 Short To Supply?	44
P3-6 Short To Supply?	46

Disconnect plug P3. If fault clears there is a problem with the wiring from P3-4 or P3-6 to the rest of the vehicle.

Armguard Active!	23
Elevation Switch Shifted?	21
Elevation Switch Stuck?	22

If the 23 flash code is triggered by armguard, it will occur once then clean. This is not a true fault but just an indication of the reason for the vehicle stop. If the 21 or 22 flash code is triggered by a fault with the elevation switch, it will not clear. Check that the elevation switch correctly opens/closes when the platform is raised/lowered.

P3-4 Short To 0V?	43
P3-6 Short To 0V?	45

Disconnect plug P3. If fault clears there is a wiring fault from P3-4 or P3-6 to the rest of the vehicle.

Invalid Load - Check Sensors	45
------------------------------	----

Check the voltage out of the pressure transducer, into P4-2. It should be between 0.5V (zero pressure) and 4.5V (maximum pressure) and should vary as the platform load & position varies.

Waiting For B+ on P2-12	52
B+ Supply Too Low	51
P4-1 Or P5-1 Short To 0V?	41

Check that the battery voltage is not too low.

Verify battery voltage on P2-12.

Disconnect plug P4 – if the fault clears there is a wiring fault from P4-1 to the rest of the vehicle.

**5.3-3 LED Error Codes - Code Breakdown Chart (Continued)**

Vehicle Tilted	11
Vehicle Overloaded	12
Too High - Drive Prevented	14
Too High - Lift Up Prevented	15

These are not true faults but an indication that vehicle movement is prevented. Remove excessive load from the platform. Lower the platform if close to maximum height. Move the vehicle to level ground.

Invalid Height - Check Sensor	65
-------------------------------	----

Check the voltage out of the height transducer, into P4-3. It should be between .4V and 4.6V and should vary as the platform position varies.

Testing HWFS	78
Start Up!	77

These are not true faults unless they do not clear.

Overload Functions Disabled!	66
Factory Override	67

These are not true faults – the GP102 has been configured to suppress overload functionality.

Idle Timeout Active!	Always Off
Fault: Bad Tilt Sensor	71
Fault: Bad HWFS	72
Fault: Bad Slave Analogs	73
Fault: Bad Strain Monitors	74
Fault: Bad Slave Micro	75
Fault HWFS Stalled!	76

Action a function to clear the idle timeout if it occurred. Ensure the GP102 is correctly mounted – incorrect mounting can cause the “bad tilt sensor” diagnostic to occur. Otherwise there may be an internal problem with the GP102.



5.3-4 Hand Held Calibration/Diagnostic Tool Key Functions

 **WARNING**

Only trained and authorized personnel shall be permitted to service and aerial platform.

 **WARNING**

Read all instructions closely before attempting each phase or the calibration procedure.

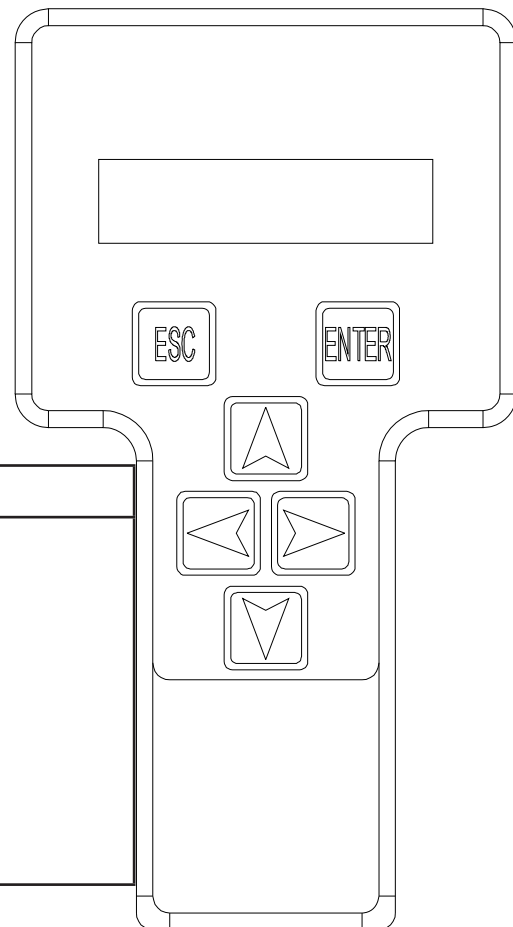

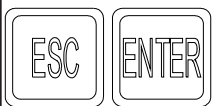
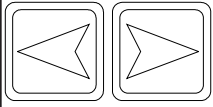
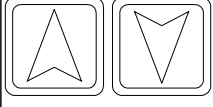
Symbol	Key Function
	<b>ESC/ENTER Buttons</b> To move back and forth between menu and sub-menu
	<b>LEFT/RIGHT Buttons</b> Select menus and setting to be adjusted
	<b>UP?DOWN BUTTONS</b> Adjust setting values

**5.3-5 Control Module Load Calibration - Code Messages & Definitions**

**During calibration the following failure message may appear:**

**Code F01: Check HWFS**

This message is given if the GP102 startup tests have not completed.

- Check [HELP](#) message for more information.

**Code F02: Not Ground Mode**

This message is given if the machine is not in ground mode (P2-2 must be high).

- Calibration can only be carried out in ground mode.

**Code F03: Not Stopped**

This message is given if any function switch is closed.

- Check [DIAGNOSTICS / SWITCHES](#) to see which function switch is closed.

**Code F04: Tilted**

This message is given if the machine is tilted.

- Calibration must be carried out with the machine level. If the machine is level, use the [SETUPS / TILT SETUPS](#) to set the GP102 level.

**Code F05: Bad Height**

This message is given if the height sensor output (P4-3) is out of range at the start of calibration.

- The height sensor output must be 3.7V. Check [DIAGNOSTICS / SENSORS](#) to see the output. A reading of 0V or 5V is probably due to a wiring problem.

**Code F06: Check Elev**

This message is given if the elevation switch (P2-10) is closed at the start of calibration, when the operator has confirmed the "PLATFORM DOWN?" question.

- If the platform is down, check the elevation switch wiring.

**Code F08: Check Elev**

This message is given if the elevation switch (P2-10) is closed at the end of calibration, when the platform should be fully raised.

- This message would occur if the UP switch was accidentally opened near the start of the lift. If the platform is fully raised, check the elevation switch wiring.

**Code F09: Bad Height**

This message is given if the height sensor output (P4-3) is out of range at the start of calibration.

- The height sensor output must be 3.7V. Check [DIAGNOSTICS / SENSORS](#) to see the output.

**Code F10: Bad Height**

This message is given if the height sensor output (P4-3) is out of range at the end of calibration.

- The height sensor output must be between 0.9V and 4.1V. Check [DIAGNOSTICS / SENSORS](#) to see the output. A reading of 0V or 5V is probably due to a wiring problem.

**Code F11: Not Up**

This message occurs at the start of calibration if the operator selects a function other than UP.

- Select the UP function only.

**Code F13: Low Height Range**

This message occurs at the end of calibration if the height sensor output did not change sufficiently to give a reasonably accurate platform height estimate.

This message could occur if the UP switch was accidentally opened too early (when the platform is not fully raised). DIAGNOSTICS / SENSORS can be used to check the height sensor output (P4-3). A difference of at least 1V is to be expected.

**Code F15: Check Elev**

This message is given if the elevation switch (P2-10) is closed when the platform has been fully lowered at the end of calibration.

This message would occur if the DOWN switch was accidentally opened before the platform was fully lowered. If the platform is fully lowered, check the elevation switch.

**Code F16: Low Elev.open**

This message is given if the elevation switch (P2-10) opened during lift at a too low height (below 5%).

- Check CALIBRATIONS / HEIGHT CALS; the "ElevUp" value shows the recorded height where the switch opened. Set up elevation switch to manufacturers' specifications and calibrate load.

**Code F17: High Elev.open**

This message is given if the elevation switch (P2-10) opened during lift at a too high height (above 25%).

- Check CALIBRATIONS / HEIGHT CALS; the "ElevUp" value shows the recorded height where the switch opened. Set up elevation switch to manufacturers' specifications and calibrate load.

**Code F18: Low Elev.close**

This message is given if the elevation switch (P2-10) closed during lower at a too low height (below 5%).

- Check CALIBRATIONS / HEIGHT CALS; the "ElevDown" value shows the recorded height where the switch opened. Set up elevation switch to manufacturers' specifications and calibrate load.

**Code F19: High Elev.close**

This message is given if the elevation switch (P2-10) closed during lower at a too high height (above 25%).

- Check CALIBRATIONS / HEIGHT CALS; the "ElevUp" value shows the recorded height where the switch opened. Set up elevation switch to manufacturers' specifications and calibrate load.

**Code F20: Height<>0%**

This message occurs if the platform height is not 0% after the platform has been fully lowered during either STATIC lift.

The platform must return to the same height each time it is fully lowered.

- Check DIAGNOSTICS / SYSTEM to check the height.

**Code F28: Bad Height**

This message indicates a problem with the height sensor output (P4-3) during calibration.

The height sensor output must be between 1.0V and 4.0V at all times.

- Check DIAGNOSTICS / SENSORS to see the output. A reading of 0V or 5V is probably due to a wiring problem.

**Code F42: Low Pressure**

This message indicates that the pressure transducer output (P4-2) is too low (0.5V or less) at the beginning of calibration.

- Check DIAGNOSTICS / SENSORS to read output.

**Code F43: High Pressure**

This message indicates that the pressure transducer output (P4-2) is too high (4.5V or more) at the beginning of calibration.

- Check [DIAGNOSTICS / SENSORS](#) to read output.

**Code F44: Low Pressure**

This message indicates that the pressure transducer output (P4-2) is too low (0.5V or less) at a measurement point.

- Check [DIAGNOSTICS / SENSORS](#) to read output.

**Code F45: High Pressure**

This message indicates that the pressure transducer output (P4-2) is too high (4.5V or more) at a measurement point.

- Check [DIAGNOSTICS / SENSORS](#) to read output.

**Code F46: Check Elev**

This message indicates that the elevation switch opened more than once during calibration lifting.

**Code F47: Check Elev**

This message indicates that the elevation switch closed more than once during calibration lower.

**Code F48: Bad Pressure**

This message indicates that the pressure transducer output (P4-2) is out of range at the beginning of calibration.

- Check [DIAGNOSTICS / SENSORS](#) to read output.

**Code F52: Too Few**

This message indicates that not enough measurements were recorded during calibration lifting or lowering.

**Code F98: Out of Range**

This message indicates that the “fine tune” calibration is unacceptable.

This is probably due to a faulty transducer or faulty/open holding valve(s)/ emergency lowering valve.

**During calibration the following information messages may appear:****Platform Down?**

This message is prompting for confirmation that the platform is fully lowered. If necessary the DOWN switch can be activated to lower the platform. Press ENTER to confirm when the platform is fully lowered.

**Platform Empty?**

This message is prompting for confirmation that the platform is completely empty. Press ENTER to confirm if the platform is empty.

**Platform Loaded?**

This message is prompting for confirmation that the platform is loaded to rated load Press ENTER to confirm if the platform is loaded.

**Please Lift**

This message is prompting for the platform to be raised. The UP switch should be closed.

**Please Lower**

This message is prompting for the platform to be lowered. The DOWN switch should be closed.

**Lift Empty**

This message is displayed while the platform is being raised to the next measurement height, when an EMPTY platform is being calibrated.

**Lift Loaded**

This message is displayed while the platform is being raised to the next measurement height, when a LOADED platform is being calibrated.

**Lifting**

This message is displayed while the platform is being raised, during HEIGHT-only calibration.

**Measuring #**

This message is displayed when the platform is stopped during calibration, when the GP102 takes a measurement. There will be a short delay while the machine is allowed to stabilize after movement is stopped.

**Must Go Down!**

This message occurs if the wrong switch is closed when the GP102 is waiting for the platform to be lowered.

**Must Go Up!**

This message occurs if the wrong switch is closed when the GP102 is waiting for the platform to be raised.

**Please Wait**

This message indicates that the GP102 is busy; the delay will be short (no more than 5 s).

**Lower Empty**

This message is displayed while the platform is being lowered to the next measurement height, when an EMPTY platform is being calibrated.

**Lower Loaded**

This message is displayed while the platform is being lowered to the next measurement height, when an EMPTY platform is being calibrated.

**Lowering**

This message is displayed while the platform is being lowered, during HEIGHT-only calibration.

**Total Data:**

This message is displayed at the end of each phase, to confirm the number of measurements recorded by the GP102.

**Caldate**

This message is prompting for the date to be entered; it is stored to identify when the machine was calibrated.

The last calibrate date can be viewed in DIAGNOSTICS / LOG. Press LEFT & RIGHT to select the flashing digits. Press UP & DOWN to change the flashing digits. Press ENTER when the entry is complete. IMPORTANT: The date 00/00/00 is not allowed!

**Finished**

This message confirms that calibration is complete and successful.

**5.3-6 Control Module Load Calibration Procedure**

1. Move the aerial platform to a test area where the platform can be elevated to its maximum working height and reach.
2. Ensure the aerial platform is parked on a firm, level surface.

**IMPORTANT**

Each phase must be completed before the next phase can be carried out.  
All phases must be completed before the aerial platform can be operated.

**IMPORTANT**

Always follow the instructions of the Calibration instrument.

**IMPORTANT**

Make sure the aerial platform is on BASE mode.

**NOTE**

To ensure a good and clear contact, clean the wire terminals before attaching the jumper clip.

3. Locate the main manifold inside the hydraulic/electric tray.
4. Disconnect the black wire #14 from the lift coil.
5. Locate the contactor on the electrical panel assembly.
6. The jumper connection must be connected between the contractor (wire #19B) and the lift coil (instead of the black wire #14)

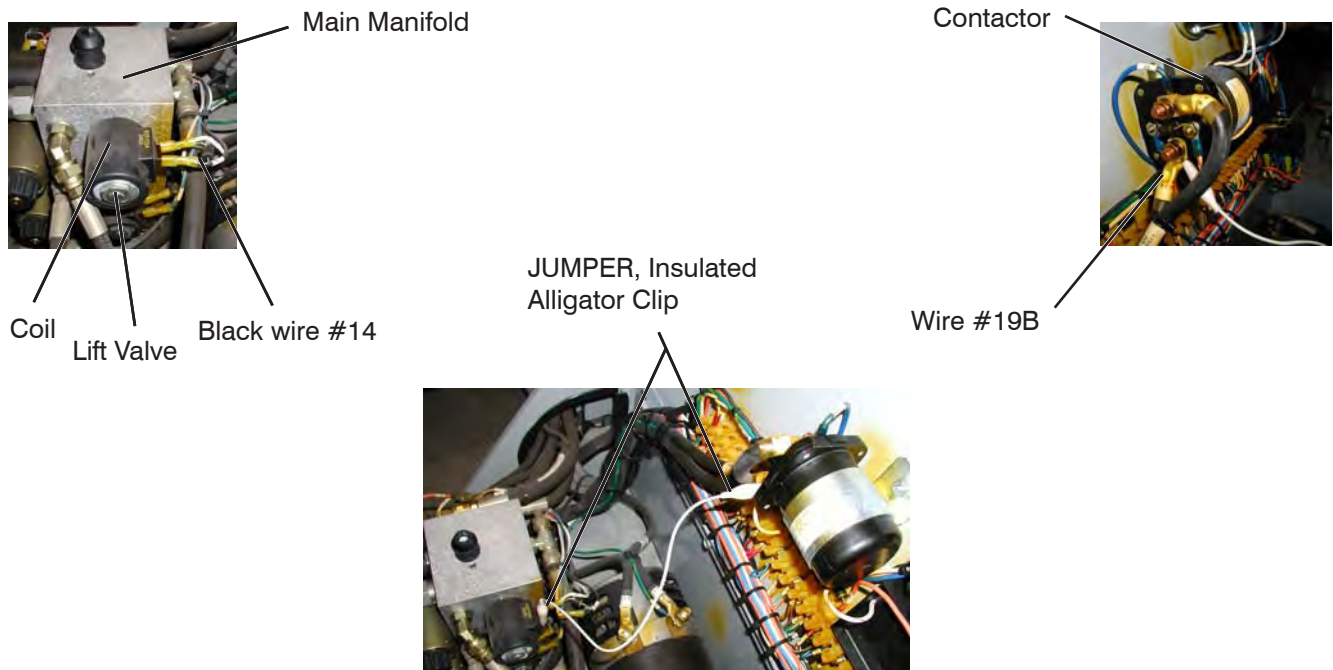

7. Connect the Easy-Cal tool to the P1 connector on the CONTROL MODULE.

8. The display will show **“Help: Press Enter”**.  
By using Left/Right buttons, select the **“Access Level ( ? )”** from the menu and press the **ENTER** button.

**Contact Skyjack Service Department at:**  
(44) 1691-676 236 for your Access Level Code Number.
9. The display will show **“Access Level Code (xxxx)”**.  
By using the Up/Down buttons, enter the Access Level Code (xxxx) followed by pressing the **ENTER** button.
10. The display will show **“Access Level 2”**.  
By using Left/Right buttons, select the **“Setups”** from the menu and press the **ENTER** button.
11. The display will show **“Machine Defaults”**.  
Select the **“Machine Defaults”** from the menu and press the **ENTER** button.
12. The display will show **“Defaults, 0 = Custom”**.  
By using Left/Right buttons, select the **“X = Group Code”** from the menu and press the **ENTER** button.
13. The display will show **“X=GROUP CODE”**. ([Refer to 5.3-7 for group code](#))  
By using the Up/Down buttons, enter the **“Group Code ( ? )”** then by using Left/Right buttons, select the **“Curve”** from the menu.
14. The display will show **“X=CURVE”**. ([Refer to 5.3-7 for curve code](#))  
By using the Up/Down buttons, enter the **“Curve Code ( ? )”** followed by pressing the **ESCAPE** button.
15. The display will show **“Machine Defaults”**.  
By using Left/Right buttons, select the **“Tilt Setups”** from the menu and press the **ENTER** button.
16. The display will show **“Tilt Setups: Calibrate Level”**.  
Select the **“Tilt Setups: Calibrate Level”** from the menu and press the **ENTER** button.
17. The display will show **“Calibrate Level: Yes: Enter, No: ESC”**.  
Select the **“Yes”** from the menu by press the **ENTER** button.
18. The display will show **“Calibrate Level: Tilt 0.0’ , 0.0”**.  
Select the **“ESCAPE”** from the menu once.
19. The display will show **“Tilt Setups Calibrate Level”**.  
Select the **“ESCAPE”** from the menu once again.
20. The display will show **“Setups Tilt Setups”**.  
By using Left/Right buttons, select the **“Load Setups”** from the menu and press the **ENTER** button.
21. The display will show **“Load Setups: Calibrate Load”**.  
Select the **“Load Setups: Calibrate Load”** from the menu and press the **ENTER** button.
22. The display will show **“Calibrate Load: Platform Down?”**.  
Asking for confirmation that the platform is fully lowered?  
Check that the platform is fully lowered then press the **ENTER** button to confirm.

23. The display will show "**Calibrate: Loaded Empty? No**".  
Asking for confirmation that the platform is empty?  
Check that the platform is empty
24. By using the Up/Down buttons, enter the "Yes" followed by pressing the **ENTER** button.
25. The display will show "**Calibrate Load: Please Lift.....**".  
Waiting for the lift switch to be activated.
26. Hold the lift switch and keep holding it until the platform is fully elevated.

**IMPORTANT**

If the lift switch is released earlier than full-height position, the calibration will have to be aborted and repeated from the beginning!

27. When the system detects the lift switch closed, the display will show "**Calibrate Load: Lift Empty**".
28. After a delay, the system will stop the platform lifting and will take height & pressure measurements; the display will show "**MEASURING # xx**". When the measurements have been taken, the platform will resume lifting.

**NOTE**

The Lifting.....stopping.....measuring....lifting process will continue until the platform reaches full height.

29. When the platform reaches full height release the lift switch.
30. The display will briefly show "**TOTAL DATA: 04**" to indicate the number of measurements taken.
31. The display will show "**Calibrate Load: Please Lower.....**".

**IMPORTANT**

If the lower switch is released earlier than full-lower position, the calibration will have to be aborted and repeated from the beginning!

32. Hold the lower switch and keep holding it until the platform is fully lowered.
33. When the system detects the lower switch closed, the display will show "**Calibrate Load: Lower Empty**".
34. After a delay, the system will stop the platform lowering and will take height & pressure measurements; the display will show "**MEASURING #xx**". When the measurements have been taken, the platform will resume lowering.

**NOTE**

The lowering.....stopping.....measuring....lowering process will continue until the platform is fully lowered.

35. When the platform is fully lowered, release the lower switch.
36. The display will show briefly "**TOTAL DATA: 04**" to indicate the number of measurements taken.
37. The display will show "**Calibrate Load: Caldate: mm/dd/yy**".  
It is recommended that the current date be entered here to provide easy taking of the data of last calibration.  
The current date must be entered using the **LEFT/RIGHT** and **UP/DOWN** buttons.



38. Press ENTER to complete date entry (the system will store it). Display will show “**FINISHED**”.
39. Remove the jumper wire and re-connect the black wire #14 to the coil removed earlier.
40. Close the hydraulic/electric tray.

**NOTE**

Continuing partially complete load calibration.

If the phase does not need to be repeated, just press **ENTER** to move on.

If the phase does need to be repeated, press **UP** or **DOWN** to change “**NO**” to “**YES**” then press **ENTER**.

## 5.3-7 Curve/Group Codes Chart

<b>Model</b>	<b>Number of Extension Platforms</b>	<b>Curve Code</b>	<b>Group Code</b>
<b>3215</b>	1 Manual Extension Platform	1	3
<b>3219</b>	1 Manual Extension Platform	2	3

60404AE\_SJ3E



Reliable lift solutions by people who care.

[www.skyjack.com](http://www.skyjack.com)