



OPERATING INSTRUCTIONS  
LITTLE LEHLE III





Dear Musician!

Thank you for purchasing the  
LITTLE LEHLE III!

I have been building units that switch, split and route signals with no technical compromises and with maximum musical fidelity since 1999. Your new LITTLE LEHLE III comprises only the very best components.

Every assembly of your LITTLE LEHLE III has been made and tested in Germany. Your LITTLE LEHLE III is of extremely robust design and construction, to make sure that you get absolutely years and years of enjoyment from it. If you should nonetheless have a problem, or simply a question, just mail me or a member of the Lehle team at:

[support@lehle.com](mailto:support@lehle.com)

I wish you the very greatest pleasure and success using your LITTLE LEHLE III!

A handwritten signature in blue ink, which appears to read "Bernd G. Lehle".

# CONTENT

- 4 Introduction
- 6 Technical data
- 7 General description
- 11 Selecting the foot switch mode
  
- Typical uses of the LITTLE LEHLE III as
  - 12 an effects loop switcher
  - 13 an effects loop switcher for inserts between send and return of an amplifier
  - 14 an A/B switcher between two amplifiers
  - 15 as an A/B switcher between two instruments
  - 16 a tuner-mute switcher
  - 17 an effects loop switcher for microphones
  
- 19 LITTLE LEHLE III signal flow diagram

The LITTLE LEHLE III - The universal Lehle switching and looping tool.

The LITTLE LEHLE III allows you to remove effects pedals from your signal path at the press of a button.

A signal can be picked off at any point in the signal chain - for example, allowing you to switch to an instrument tuner. The LITTLE LEHLE III can also be used to switch between two instruments with one amp or, vice versa, between two amps with one instrument.

Extremely diverse sound sources are no problem. Signals from pickups, microphones and keyboard line-out sockets are routed loss-free to a target amplifier or recorder.

All jack sockets are stereo, so you can re-route balanced signals too.

With the release of the LITTLE LEHLE III you can now combine mono and stereo signals. This will allow you to integrate an effects pedal with a mono input and stereo output into the signal path of the LITTLE LEHLE III without limitations.

The LEHLE-Switch works with a micro-controller and an intelligent true bypass relay circuit with an active pop suppression function, thereby allowing the LITTLE LEHLE III to switch even faster than mechanical switches, noise-free and without wear.

The easy-action mushroom-shaped button characteristic of LEHLE products is mounted in the cover so that your foot pressure is transmitted indirectly via a spring. Thus the circuit board is not exposed to mechanical loads, making the LITTLE LEHLE III virtually indestructible and guaranteeing years of trouble-free switching.

Not only is the stereo signal switched, but also the earth, - so say 'goodbye' to hum when switching between two amps, and selecting effects loops - it just can't happen anymore.

New for the LITTLE LEHLE III are the three operating modes, making the switch work as either a latching or momentary switch, allowing for short or rhythmic stutter-effects.

The third mode combines a mixture of operating mode one and two: a short press engages the latching function and a long press is momentary.

Think of the creative potential.

We take care of your signal so that you can take care of the music.



## TECHNICAL DATA

Weight	350 g
Length	3.55"
Width	3.8"
Overall height	1.85"
Supply voltage	9-15 V DC
Current consumption	70 mA
Max level	+30 dBu

## GENERAL DESCRIPTION

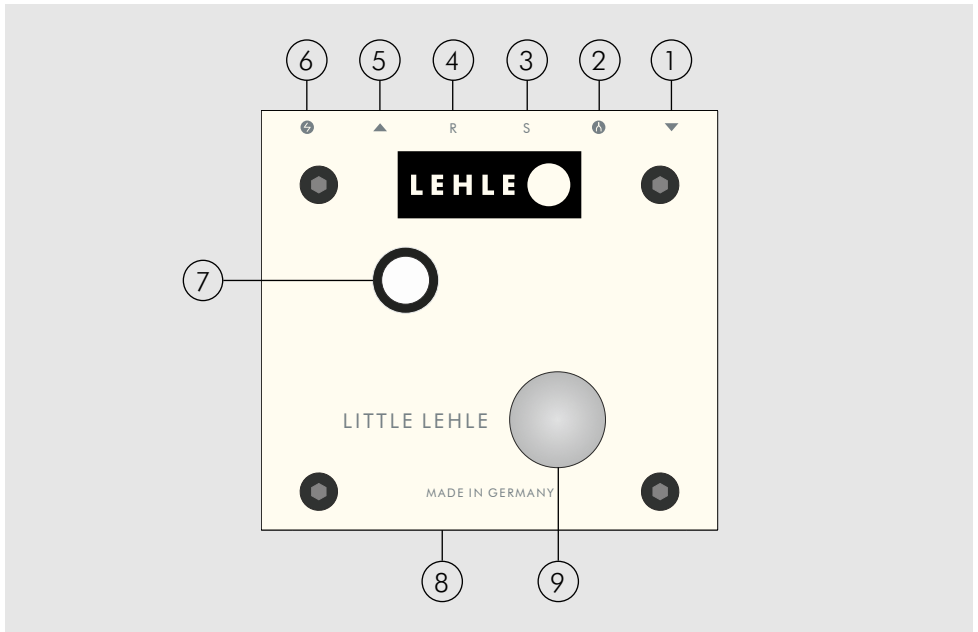

### 1. INPUT SOCKET



Connect your instrument to this socket.

The input signal enters via this socket. Like all the jack plugs on the LITTLE LEHLE III, the socket is of stereo type.

The LITTLE LEHLE III thus switches stereo signals (such as stereo effects or keyboards) and balanced signals (like those from microphones, for instance) and, of course, simple mono signals, like that of an electric guitar.

The LED (7) shows white when the signal is present on the output (5) together with the ground (earth) connection.

Press the True-Bypass switch (9) and the stereo signal and ground connection are routed to the S socket (3). The LED will now show blue.

Switching of the ground connections eliminates the possibility of hum loops.

## 2. MONO-TO-STEREO SWITCH

Activates at the input socket the mono-to-stereo function.

If this switch is not pressed, the LITTLE LEHLE III works with either mono or stereo signals. This means, all sockets should be occupied with either mono jacks (TS) or stereo jacks (TRS). By doing this you can place a mono or stereo effects pedal in the loop of the LITTLE LEHLE III.

Some effects offer a stereo output, but a mono input. If the mono-to-stereo switch is pressed, the input (1) and send (3) can be occupied with mono jacks (TS), while the return (4) and output (5) transfer a stereo signal via stereo jacks (TRS).

If the LITTLE LEHLE III is activated the input signal will be sent in mono to the effects pedal. The output of the effect can be returned in stereo to the return (4) and sent out to the output (5) in stereo. If the LITTLE LEHLE III is deactivated the mono signal will be split straight after the input and sent loss-free to the output (5).

## 3. SEND SOCKET

Connect the input of your effects unit or amplifier to this socket.

Depending on the application, this socket is either connected to the input of one or more effects units, to a second amplifier or, for example, to a tuner.

## 4. RETURN SOCKET

Connect the output of your effects unit or a second instrument to this socket.

This socket can be used for connection to the output of an effects unit, to the last output of a complete effects chain or, for example, can also be used for a second instrument. It has no function if the LITTLE LEHLE III is used as an A/B box for operation with two amplifiers.

## 5. OUTPUT SOCKET

Connect your amplifier to this socket.

The output signal is routed out of the LITTLE LEHLE III via this socket. The LED (7) shows white when the input signal together with the ground connection is directly present here. Pressing the foot switch (9) routes the R(eturn) socket signal (4) together with the ground connection to the output socket.

If you are using the output socket to send a stereo signal to two amplifiers, a ground loop occurs which can cause hum and noise. We recommend galvanically isolating one amplifier by using the LEHLE LITTLE DUAL II or the LEHLE P-SPLIT III. 



## 6. EXTERNAL POWER SUPPLY



Connect a power supply with a voltage of 9 – 15 V.

In order that the LITTLE LEHLE III can work flawlessly, it needs a current supply. This should supply a minimum of 9 V and a maximum of 15 V. Polarity is of no importance. The supply voltage is internally rectified and stabilized in order to guarantee trouble-free operation. In order to avoid noise it's recommendable to use a single power supply or an output of a multi power supply offering galvanically isolated outputs for the LITTLE LEHLE III.

## 7. LED FOR SWITCHING STATUS

If the LED shows white, the input (1) is directly connected to the output (5).

The high-intensity LED clearly indicates the current switching status - even under bright spotlights.

When you use the LITTLE LEHLE III as an effects loop switcher and the LED shows white, the effects are in Bypass, when blue they are in the signal path.

If you use it as A/B switch between two amplifiers it means the LED is white for the amplifier at the output (5) and blue for the amplifier at the send (3).

Same applies for switching between two instruments: LED white means that the instrument at the input (1) is active, blue applies for the instrument at the return (4).

## 8. BASE AND FIXING

If required, mount the LITTLE LEHLE III to a pedalboard using the mounting kit.

The LITTLE LEHLE III can be mounted to a plate such as a pedalboard using the two holes in the bottom of the pedal.

You can find the optional LEHLE Mounting Kit V3 (order number 100981) online at [www.lehle-components.com](http://www.lehle-components.com).

To mount, undo the four housing screws by using a 2.5 mm Allen Key and detach the cover.

Then fix the device base to a base plate using the two screws, the washers and the spacers of the Mounting Kit.

Attach the cover and tighten the four housing screws - done!

For flexible solutions we recommend using 3M Dual Lock™ instead of Velcro for stability, which you can also find in handy sizes at [www.lehle-components.com](http://www.lehle-components.com)

Tip: if you are using the Velcro / Dual Lock™ method, please make a note of the serial number on the bottom of the pedal before you cover it, in case you have a support question for us later and don't fancy dismantling your board!



## 9. TRUE-BYPASS SWITCH

Here you can switch.

The LITTLE LEHLE III switches all audio signals controlled by a microcontroller and an intelligent True-Bypass-Relay-Circuit with an active pop suppression function.

Triggered by the easy-action mushroom-shaped button characteristic of LEHLE products mounted in the cover so that your foot pressure is transmitted indirectly via a spring. Thus the circuit board is not exposed to mechanical loads, making the LITTLE LEHLE III virtually indestructible and guaranteeing years of trouble-free switching.

According to the foot switch mode following configurations are given:

- Latching Mode:  
the LEHLE foot switch „latches“ by a press and release.
- Momentary Mode:  
the LEHLE foot switch triggers a contact and disconnects once released.
- Mixed Mode:  
a mix between latching and momentary. A short press lets the foot switch act as latching, a longer press is momentary

You will find out how to change the behaviour in chapter “Selecting the foot switch mode” on page 11.



## SELECTING THE FOOT SWITCH MODE

You can change the behaviour of the foot switch, so it works latching, momentary or in a mixed mode.

According to the foot switch mode following configurations are given:

- Latching Mode:

The LEHLE foot switch „latches“ by a press and release.

- Momentary Mode:

The LEHLE foot switch triggers a contact and disconnects once released.

- Mixed Mode:

A mix between latching and momentary. A short press lets the foot switch act as latching, a longer press is momentary.

To change the mode please proceed as follows:

1. Disconnect the power supply.
2. Press and hold the foot switch.
3. Reconnect the power.
4. The LED starts flashing in following order:
  - for Latching Mode
  - for Momentary Mode
  - for Mixed Mode
5. If you release the foot switch after the first flash, the Latching Mode is selected. After 2x flashes you're in the Momentary Mode and after 3x it's the Mixed Mode.
6. The LITTLE LEHLE III turns off and re-boots.

The selection of the foot switch mode is stored inside and recalled every time the pedal is powered on. 

## TYPICAL USES

### LITTLE LEHLE III AS AN EFFECTS LOOP SWITCHER

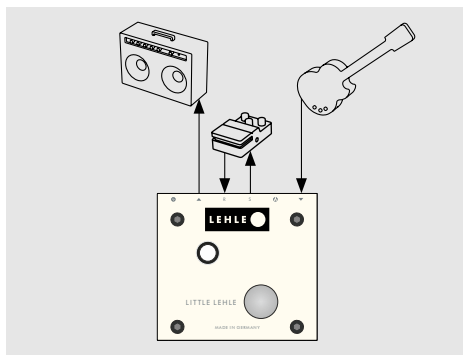

You can use the LITTLE LEHLE III as an effects loop switcher for individual effects units, and also for complete pedal boards.





Not all effects pedals feature True-Bypass, and those that don't can cause signal losses when deactivated.

The LITTLE LEHLE III makes it possible to eliminate them from the signal path completely in just one step.

#### HOW TO DO THIS

1. Connect your instrument to the Input socket (1) of the LITTLE LEHLE III.
2. Connect the Send (3) of the LITTLE LEHLE III to the input of the effects unit.
3. Connect the output socket of the effects unit with the Return socket (4) of the

#### DEVICE CONNECTION

	Input	Instrument
	Send	Input effect(s)
	Return	Output effect(s)
	Output	Amplifier

#### LITTLE LEHLE III.

4. Connect the Output socket (5) to the input of your amplifier.
5. There you go!



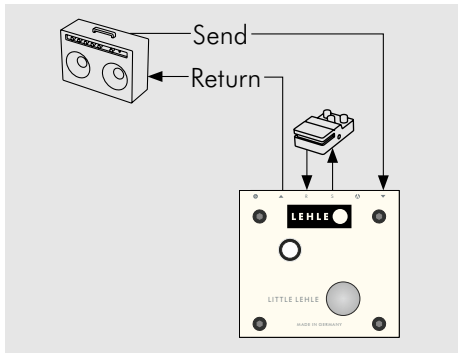

This works equally well with both mono and stereo effects. If you are using stereo effects with a mono input, make sure that the input (1) and send (3) are mono jacks (TS) and the return (4) and output (5) are stereo jacks (TRS). Please press the mono-to-stereo switch (2) too, in order to ensure the mono signal is internally distributed to stereo correctly. ✓

# LITTLE LEHLE III AS AN EFFECTS LOOP SWITCHER FOR INSERTS BETWEEN SEND AND RETURN OF AN AMPLIFIER



The LITTLE LEHLE III can also be excellently used in FX loops of amplifiers to loop in pedals or even 19"-effects. This way a non-switchable amplifier FX loop can be converted to be switchable and remote-controlled. Low-impedance signals with high level the LITTLE LEHLE III easily switches without loss of signal.

## DEVICE CONNECTION

	Input	Amplifier send
	Send	Input effect(s)
	Return	Output effect(s)
	Output	Amplifier return



## HOW TO DO THIS

1. Connect the send of your amplifier to the input socket (1) of the LITTLE LEHLE III.
2. Connect the Send (3) of the LITTLE LEHLE III to the input of the effects unit.
3. Connect the output socket of the effects unit with the Return socket (4) of the LITTLE LEHLE III.
4. Connect the Output socket (5) to the return of your amplifier.
5. There you go!

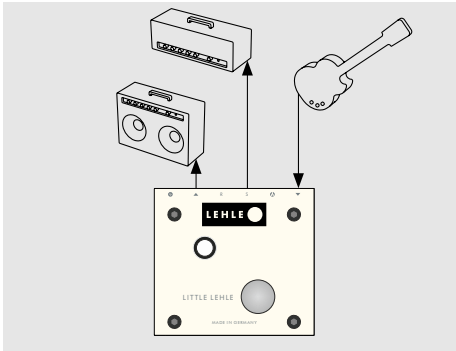
# LITTLE LEHLE III AS AN A/B SWITCHER BETWEEN TWO AMPLIFIERS



## DEVICE CONNECTION

	Input	Instrument
	Send	Amplifier 1
	Output	Amplifier 2

The LITTLE LEHLE III can be extremely useful for switching, when playing live with two amps, for instance, between the clean sound of amp A and the distorted sound of amp B. It also enables you to switch quickly between familiar sounds, or to compare A and B, when you are in the studio or the rehearsal room.

## HOW TO DO THIS

1. Connect your instrument to the input socket (1) of the LITTLE LEHLE III.
2. Connect the Send (3) of the LITTLE LEHLE III to the input of the amplifier 1.
3. Do not use the return socket (4).
4. Connect the Output socket (5) to the input of your amplifier 2.
5. There you go!

Most amplifiers are connected to a power supply using a three-core cable: two cores supply the power, while the third core is the equipment grounding conductor which grounds the amplifier.

If this ground core is installed, it must, for safety reasons, never be removed, taped off or disconnected!



Because of the grounding and the signal ground of the guitar, two amplifiers connected to one guitar can generate background noise. 

This background noise is called “ground loop”. You are guaranteed not to have ground loops when you use the LITTLE LEHLE III, because it not only switches the signal back and forth between the amplifiers, but also, simultaneously, the signal ground.

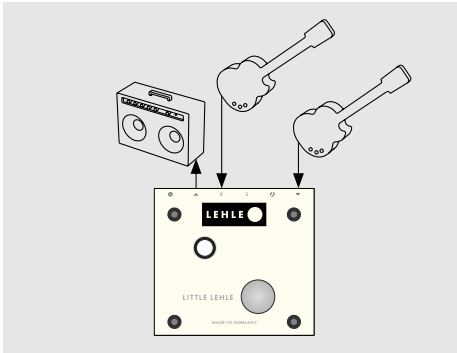
# LITTLE LEHLE III AS AN A/B SWITCHER BETWEEN TWO INSTRUMENTS



## DEVICE CONNECTION

	Input	Instrument 1
	Return	Instrument 2
	Output	Amplifier

In order to swap between two instruments quickly and easily, you can install the LITTLE LEHLE III between the instruments and the rest of your setup. If you are playing live with a wireless system, the LITTLE LEHLE III can easily select between the receivers too.

It is not always possible to mute your amplifier or PA channel, and just pulling out the plug can cause nasty popping from the speakers.

## HOW TO DO THIS

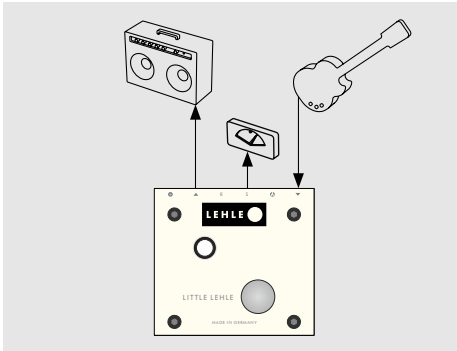

1. Connect your first instrument to the input socket (1) of the LITTLE LEHLE III.
2. Do not use the send socket (3).
3. Connect your second instrument to the return socket (4) of the LITTLE LEHLE III.
4. Connect the Output socket (5) to the input of your amplifier or pedalboard.
5. There you go!

## LITTLE LEHLE III AS A TUNER-MUTE SWITCHER



Even in smaller setups with only one guitar and one amplifier, the LITTLE LEHLE III can help by muting the signal while you are tuning, so that your audience and your bandmates do not hear you.

### DEVICE CONNECTION

	Input	Instrument
	Send	Tuner
	Output	Amplifier

### HOW TO DO THIS

1. Connect your instrument to the input socket (1) of the LITTLE LEHLE III.
2. Connect your tuner to the send socket (2).
3. Do not use the return socket (4).
4. Connect the Output socket (5) to the input of your amplifier or pedalboard.
5. There you go!



## LITTLE LEHLE III AS AN EFFECTS LOOP SWITCHER FOR MICROPHONES

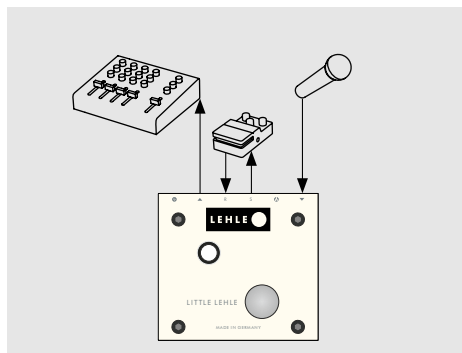





The usage of effects to manipulate the sound of your voice is already commonplace.

The LITTLE LEHLE III is optimally suitable for this function, too, since it can also switch balanced signals.

It does not have to be a microphone, of course - the LITTLE LEHLE III also switches other balanced signal sources.

### DEVICE CONNECTION

	Input	Microphone
	Send	Input effect(s)
	Return	Output effect(s)
	Output	Mixer

### HOW TO DO THIS

1. Connect your microphone to the input socket (1) of the LITTLE LEHLE III.
2. Connect the send socket (3) to the input of your effects unit.
3. Connect the output to the return socket (4) of the LITTLE LEHLE III.
4. Connect the output socket (5) to the input of a mixer.
5. There you go!

Signals from microphones that require phantom power cannot be switched this way, since this would mean that the phantom power would be switched off and on. Switching phantom power off and on generally causes a loud noise.



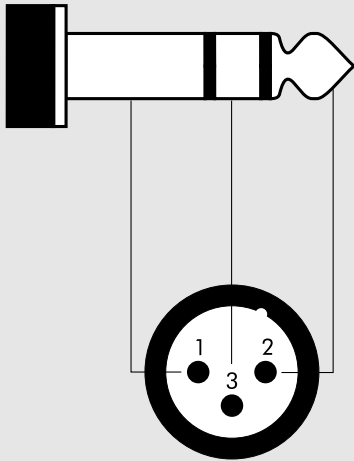

Balanced signal lines are fitted with XLR connectors or TRS (Tip Ring Sleeve) jack plugs. In a balanced signal line, the signal is present in phase at the tip, as in the case of an unbalanced signal line (XLR Pin 2). The second signal conductor carries the same signal, but with the opposite polarity or mirror-image phase (Ring, XLR Pin 3). The third conductor is the screening, and again constitutes the signal ground (Sleeve, XLR Pin 1). ✓

JACK	CABLE	XLR
Sleeve	Ground	Pin 1
Ring	Signal in mirrored phase	Pin 3
Tip	Signal in phase	Pin 2

# LITTLE LEHLE III SIGNAL FLOW DIAGRAM

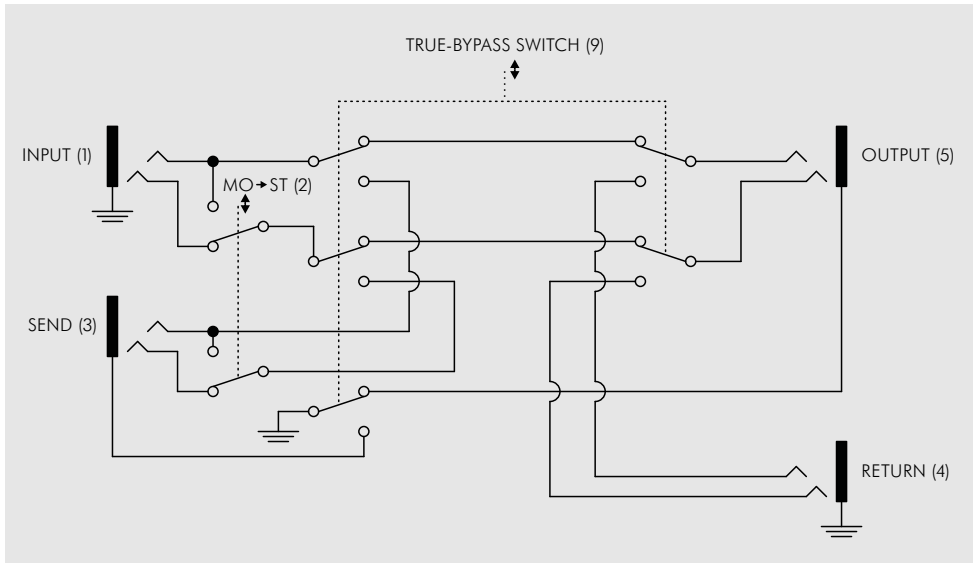



LEHLE GmbH · Grenzstrasse 153 · 46562 Voerde · Germany

[www.lehle.com](http://www.lehle.com) · [support@lehle.com](mailto:support@lehle.com)

LITTLE LEHLE III OPERATING INSTRUCTIONS V1.0 · 2019-08-01

Copyright 2019 by LEHLE