

**ADEMCO VISTA SERIES**  
**VISTA-20P / VISTA-20PSIA**  
**VISTA-15P / VISTA-15PSIA**  
**Security Systems**

**Installation and Operation Guide**

# RECOMMENDATIONS FOR PROPER PROTECTION

## The Following Recommendations for the Location of Fire and Burglary Detection Devices Help Provide Proper Coverage for the Protected Premises.

### Recommendations For Smoke And Heat Detectors

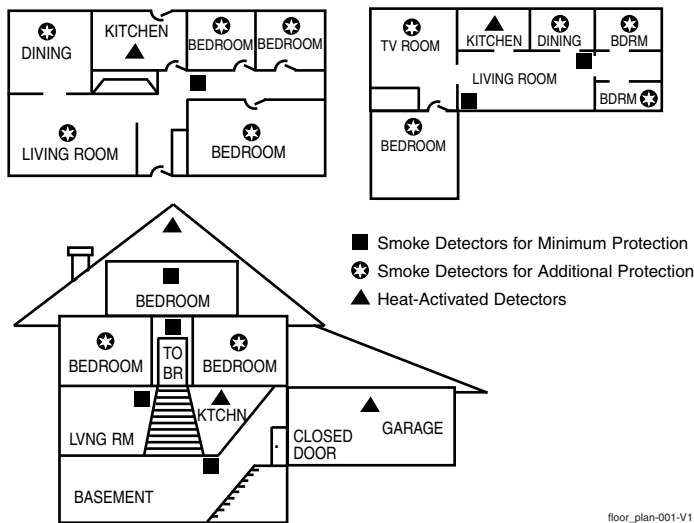
With regard to the number and placement of smoke/heat detectors, we subscribe to the recommendations contained in the National Fire Protection Association's (NFPA) Standard #72 noted below.

Early warning fire detection is best achieved by the installation of fire detection equipment in all rooms and areas of the household as follows: For minimum protection a smoke detector should be installed outside of each separate sleeping area, and on each additional floor of a multi-floor family living unit, including basements. *The installation of smoke detectors in kitchens, attics (finished or unfinished), or in garages is not normally recommended.*

For additional protection the NFPA recommends that you install heat or smoke detectors in the living room, dining room, bedroom(s), kitchen, hallway(s), attic, furnace room, utility and storage rooms, basements and attached garages.

In addition, we recommend the following:

- Install a smoke detector inside every bedroom where a smoker sleeps.
- Install a smoke detector inside every bedroom where someone sleeps with the door partly or completely closed. Smoke could be blocked by the closed door. Also, an alarm in the hallway outside may not wake up the sleeper if the door is closed.
- Install a smoke detector inside bedrooms where electrical appliances (such as portable heaters, air conditioners or humidifiers) are used.
- Install a smoke detector at both ends of a hallway if the hallway is more than 40 feet (12 meters) long.
- Install smoke detectors in any room where an alarm control is located, or in any room where alarm control connections to an AC source or phone lines are made. If detectors are not so located, a fire within the room could prevent the control from reporting a fire or an intrusion.



**THIS CONTROL COMPLIES WITH NFPA REQUIREMENTS FOR TEMPORAL PULSE SOUNDING OF FIRE NOTIFICATION APPLIANCES.**

### Recommendations For Proper Intrusion Protection

For proper intrusion coverage, sensors should be located at every possible point of entry to a home or commercial premises. This would include any skylights that may be present, and the upper windows in a multi-level building.

In addition, we recommend that radio backup be used in a security system so that alarm signals can still be sent to the alarm monitoring station in the event that the telephone lines are out of order (alarm signals are normally sent over the phone lines, if connected to an alarm monitoring station).

**NOTE:** Copies of the Programming, Installation, and User Guides must be left with the end user.

# Table Of Contents

|   |            |
|---|------------|
| <b>Features and Installation Highlights</b> .....               | <b>1-1</b> |
| Capabilities and Functions .....                                | 1-1        |
| Compatible Devices .....  | 1-2        |
| Important Installation Highlights (Installer Please Read) ..... | 1-2        |
| <b>Mounting and Wiring the Control</b> .....                    | <b>2-1</b> |
| Installing the Control Cabinet and PC Board.....                | 2-1        |
| Cabinet and Lock .....  | 2-1        |
| Mounting the PC Board Alone (no RF Receiver).....               | 2-1        |
| Mounting Board with RF Receiver.....                            | 2-1        |
| Auxiliary Device Current Draw Worksheet.....                    | 2-2        |
| AC Power, Battery, and Ground Connections.....                  | 2-3        |
| 1321 Transformer .....  | 2-3        |
| Battery Connections .....                                       | 2-3        |
| Battery Saver Feature .....                                     | 2-3        |
| Earth Ground .....  | 2-3        |
| Sounder (Bell) Connections.....                                 | 2-4        |
| Basic Connections .....   | 2-4        |
| Supervised output .....   | 2-4        |
| Connecting the Keypads and Other Addressable Devices.....       | 2-4        |
| Connections .....   | 2-4        |
| Supplementary Power (optional).....                             | 2-4        |
| Keypad Notes .....  | 2-5        |
| Communication Device.....                                       | 2-5        |
| (Long Range Radio) Connections .....                            | 2-5        |
| Table of Device Addresses .....                                 | 2-5        |
| Hardwire Zones and Zone Expansion.....                          | 2-6        |
| Hardwire Zones.....   | 2-6        |
| Double-Balanced Zones.....                                      | 2-6        |
| Zone Doubling .....   | 2-6        |
| Smoke Detectors .....   | 2-6        |
| Smoke Detector Notes.....                                       | 2-7        |
| 4219/4229 Expansion Zones .....                                 | 2-7        |
| Installing the RF Receiver and Wireless Transmitter Zones ..... | 2-8        |
| Compatible Receivers .....                                      | 2-8        |
| Receiver Connections.....                                       | 2-8        |
| RF Receiver Notes.....  | 2-8        |
| Installing the Transmitters.....                                | 2-9        |
| Transmitter Battery Life.....                                   | 2-9        |
| Connecting Relay Modules and Output Triggers.....               | 2-10       |
| 4204/4229 Relay Modules .....                                   | 2-10       |
| On-Board Triggers .....   | 2-10       |
| Phone Line and Audio Alarm Verification (AAV) Connections.....  | 2-11       |
| Phone Line .....  | 2-11       |
| Audio Alarm Verification Connections .....                      | 2-11       |
| Audio Alarm Verification Connections .....                      | 2-12       |

# Table Of Contents

|   |            |
|---|------------|
| <b>System Communication and Operation</b> .....           | <b>3-1</b> |
| Panel Communication with Central Station .....            | 3-1        |
| Report Code Formats.....                                  | 3-1        |
| Ademco Contact ID® .....                                  | 3-3        |
| Uploading/Downloading via the Internet .....              | 3-4        |
| System Security Codes .....                               | 3-5        |
| Panic Keys.....   | 3-7        |
| Setting the Real-Time Clock .....                         | 3-7        |
| Various System Trouble Displays.....                      | 3-8        |
| <b>Testing the System</b> .....                           | <b>4-1</b> |
| About Test Procedures .....                               | 4-1        |
| System Test.....  | 4-1        |
| Checking Transmitter Enrollment (Sniffer Mode).....       | 4-1        |
| Go/No Go Test Mode .....                                  | 4-2        |
| Dialer Communication Test and Periodic Test Reports ..... | 4-2        |
| Automatic Standby Battery Tests.....                      | 4-2        |
| <b>Specifications &amp; Accessories</b> .....             | <b>5-1</b> |
| Security Control.....                                     | 5-1        |
| Compatible Devices .....                                  | 5-1        |
| <b>Regulatory Agency Statements</b> .....                 | <b>6-1</b> |
| <b>Limitations and Warranty</b> .....                     | <b>7-5</b> |

# Features and Installation Highlights

**This manual applies to the following Honeywell security systems:**

ADEMCO VISTA-20P/ADEMCO VISTA-20PSIA/ADEMCO VISTA-20PCN (collectively referred to as VISTA-20P series), ADEMCO VISTA-15P/ADEMCO VISTA-15PSIA/ADEMCO VISTA-15PCN (collectively referred to as VISTA-15P series)

**NOTE:** Canadian units and power supplies have not been evaluated by ULC

Features and procedures apply to all, except where differences are noted.

**SIA Installations:** The VISTA-20PSIA and VISTA-15PSIA are certified SIA-compliant controls that meet SIA specifications for False Alarm Reduction. The other controls described in this manual are not certified as SIA compliant, but can be programmed for False Alarm Reduction. To program for False Alarm Reduction, follow the SIA Guidelines noted in the applicable programming fields.

## Capabilities and Functions

| Feature/Function                       | VISTA-20P Series  | VISTA-15P Series   |
|--|---|--|
| Partitions                             | <ul style="list-style-type: none"> <li>• 2 partitions, can protect two independent areas</li> <li>• Common partition option allows either partition to arm, while leaving a common area (ex. lobby or foyer) disarmed for access into the other partition.</li> </ul>   | VISTA-15P is not a partitioned system.   |
| Zones                                  | Up to 48 protection zones plus 16 keyfob zones (zones 49-64) for total of 64 zones: <ul style="list-style-type: none"> <li>• 8 basic hardwired zones (zones 1-8) with optional zone-doubling feature</li> <li>• Up to 40 additional wired zones (zones 9-48) using up to 5 4219/4229 modules</li> <li>• Up to 40 wireless transmitter zones (5800 series; zones 9-48)</li> <li>• Up to 4 configurable zone types</li> </ul>   | Up to 32 zones plus 8 keyfob zones (zones 49-56) for total of 40 zones: <ul style="list-style-type: none"> <li>• 6 basic hardwired zones (zone 1-6)</li> <li>• Up to 16 additional wired zones (zones 9-24) using up to 2 4219/4229 modules</li> <li>• Up to 26 wireless transmitter zones (5800 series; zones 9-34)</li> <li>• Up to 2 configurable zone types</li> </ul> |
| Security Codes                         | Up to 48 Security Codes, with separate authority levels and partition access  | Up to 32 Security Codes, with separate authority levels  |
| One-button arming                      | Dedicated keys can arm the system.  | Dedicated keys can arm the system.   |
| Schedules                              | Up to 32; can control devices and/or auto-arm/disarm  | Up to 8; can control devices and/or auto-arm/disarm  |
| Keypad macros                          | Up to 4; activated by wired keypads   | Up to 2; activated by wired keypads  |
| Paging                                 | Up to 4 pagers; certain system conditions can report to pagers; can use a dedicated key on keypads to send a signal to a pager  | Up to 2 pagers; certain system conditions can report to pagers; can use a dedicated key on keypads to send a signal to a pager   |
| Event Logging                          | 100 events; display via Compass Downloader software or installer/master code at Keypad  | 50 events; display via Compass Downloader software or installer/master code at Keypad  |
| Zone descriptors                       | Can assign for all zones (for alpha display keypads).   |  |
| Bell supervision                       | Optional, detects external sounder wiring short (when in alarm) or open (when bell is off); causes a trouble condition, keypad display, and sends a report to the central monitoring station, if enabled (field *91, option 1).   |  |
| RF jam detection                       | Optional, for wireless systems detects a condition that may impede proper RF reception (i.e., jamming or other RF interference); causes keypad display, and sends a report to the central monitoring station (if trouble reporting is enabled).   |  |
| Telephone Line Monitoring              | Built-in option can monitor the telephone line voltage and can cause a local display, or a display and trouble/alarm sound.   |  |
| Downloading via Phone Line or Internet | Via Standard Phone Line: Use an IBM compatible computer, Compass downloading software, and a compatible HAYES or CIA modem specified by Honeywell.<br>Via Internet: supports Upload/Download via the Internet/Intranet when used with an appropriate communications device (ex. 7845i-GSM) and Compass downloading software. This allows site maintenance independent of central station monitoring, and modification to sites globally via the Internet.<br><b>UL NOTE:</b> Uploading/Downloading via the Internet has not been evaluated by UL. |  |

## Compatible Devices

| Device                                  | VISTA-20P                       | VISTA-15P                       | Notes  |
|---|---------------------------------|---------------------------------|--|
| Addressable Keypads                     | 8                               | 8                               | 6150 Fixed-Word Keypad, 6160 Alpha Keypad, 6150V Fixed-Word Display Voice Keypad, 6160V Alpha Display Voice Keypad, 6150RF Keypad/Transceiver  |
| Touch Screen (AUI) Devices              | 4                               | 2                               | Touch Screen (AUI) devices are in addition to the 8 addressable keypads. E.g., 6280, Tuxedo Touch  |
| 4219, 4229 Zone Expander Modules        | Up to 5 for up to 40 exp. zones | Up to 2 for up to 16 exp. zones | Zone numbers are predefined according to the device addresses used. See Expander Module Addresses table in Wiring section and set addresses accordingly.   |
| 5800 Series Wireless                    | Up to 40 RF zones               | Up to 26 RF zones               | Uses 5881/5883 Series Receivers/Transceivers.  |
| Output relays                           | Up to 16                        | Up to 8                         | Use any combination of 4204, 4229 .<br>Map output devices via *79 Menu mode.   |
| On-Board Triggers                       | 2                               | 2                               | Can be used to reset 4-wire smoke detectors.   |
| Output functions                        | Up to 48                        | Up to 24                        | Program output functions via *80 Menu mode.  |
| Audio Alarm Verification                | Using AAV module                | Using AAV module                | Use Honeywell AVS or Eagle Model 1250 in conjunction with an output trigger to permit voice dialog between an operator at the central station and a person at the premises. The AVS system can be used to provide AAV via phone line or AlarmNet IP/GSM (using a GSMV4G module). |
| Alarm output                            | 12VDC, 2 AMP output             | 12VDC, 2 AMP output             | Can drive the compatible sounders; steady output for burglary/panic, or temporal pulse (3 pulses – pause – 3 pulses – pause – 3 pulses. . .) for fire. Uses current limiting circuitry for protection.   |
| Auxiliary Power Output                  | See note.                       | See note                        | 12VDC, 600 mA maximum; uses circuit protection.  |
| Backup Battery                          | See note.                       | See note.                       | Rechargeable (sealed lead-acid type) 12VDC, 4AH minimum.   |
| Communication Device (Long Range Radio) | See note.                       | See note.                       | Messages normally intended for the primary telephone number can be reported via ECP connection to various communication devices (check compatibility/availability of specific models)  |
| AC Power Supply                         | See note.                       | See note.                       | Plug-in 120VAC transformer, 1321 (1321CN in Canada)  |

**NOTE:** All devices and accessories used in a Canadian installation must be Listed for use in Canada.

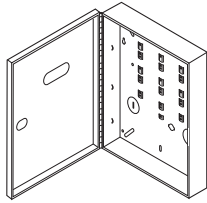
### Important Installation Highlights (Installer Please Read)

- This system uses addressable keypads and Zone Expander Modules (see Table of Addresses in *Section 2. Mounting and Wiring – Connecting the Keypads and Other Addressable Devices*).
- Keypads must be set for addresses 16-23 (first keypad is address 16, which is different from previous controls) and programmed in data fields \*190-\*196.
- Zone Expander Modules must be set for specific addresses (07-11), based on the zone numbers used.
- 4204 Relay Modules must be set for specific addresses (12-15).
- This control will not power-up unless AC power is connected (will not power-up on battery alone). However, once the system is powered up, it will operate on battery power in the event of AC loss.
- Relays have two programming menu modes: Use \*79 Menu mode to map module addresses and device (output) numbers. Use \*80 Menu mode to define the output functions.
- This system supports programmable function keys. Use \*57 Menu mode to define the function keys.

# Mounting and Wiring the Control

## Installing the Control Cabinet and PC Board

### Cabinet and Lock



1. Remove the cabinet door. Remove the cabinet knockouts needed for wiring entry.
2. Mount the control cabinet to a sturdy wall in a clean, dry area, which is not readily accessible to the general public, using fasteners or anchors (not supplied) with the four cabinet mounting holes.
3. When installation and wiring is completed, install the cabinet door and secure by using 2 screws (supplied) through the door's edge.

**OPTIONAL KEY LOCK:** If desired, a key lock can be installed (K4445V1). Remove the lock knockout from the door. Insert the key into the lock. Position the lock in the hole, making certain that the latch will make contact with the latch bracket when the door is closed. When correctly positioned, push the lock until the snap tabs hold it securely.

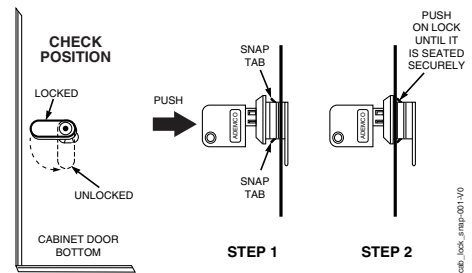
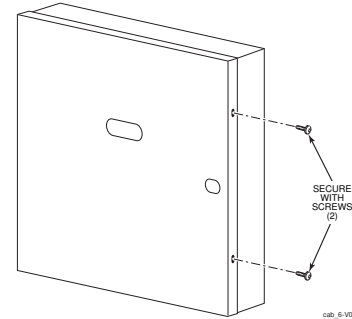


Figure 1. Installing the Door and Cabinet Lock

### Mounting the PC Board Alone (no RF Receiver)

Before installing the cabinet's contents, remove the metal cabinet knockouts required for wiring entry. Do not remove the knockouts after the circuit board has been installed.

1. Hang two short mounting clips (provided) on the raised cabinet tabs (see Detail B).
2. a. Insert the top of the circuit board into the slots at the top of the cabinet. Make sure that the board rests on the correct row (see Detail A).
- b. Swing the base of the board into the mounting clips and secure the board to the cabinet with the accompanying screws (see Detail B).

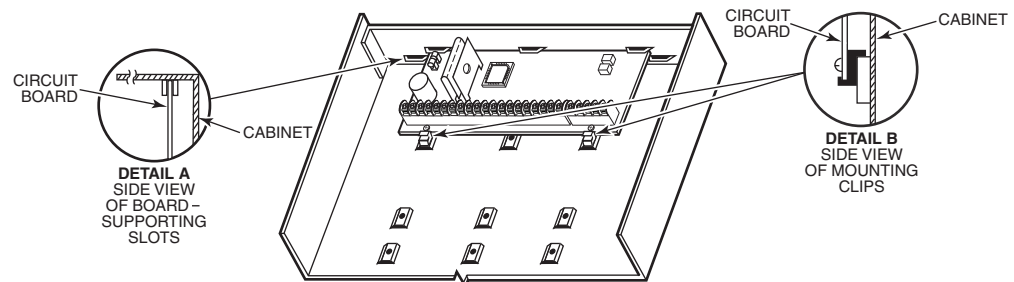


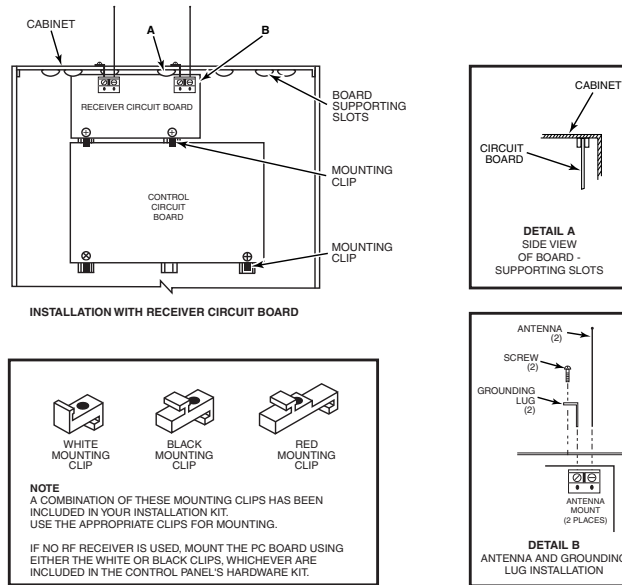
Figure 2. Mounting the PC Board

### Mounting Board with RF Receiver

- Do not mount the cabinet on or near metal objects. This will decrease RF range and/or block RF transmissions from wireless transmitters.
  - Do not locate the cabinet in an area of high RF interference (revealed by frequent or prolonged lighting of the LED in the receiver (random flicker is OK))
1. a. Remove the receiver board from its case, then insert the top of the board into the slots at the top of the cabinet, as shown in Detail A in Figure 3 on the next page. Make sure that the board rests on the correct row of tabs.
  - b. Swing the base of the board into the mounting clips and secure it to the cabinet with the accompanying screws.
  - c. Insert the top of the control's board into the slot in the clips and position two clips at the lower edge of the board.
  - d. Swing this board into place and secure it with two additional screws.

**Mounting Board with RF Receiver (continued)**

2. Insert grounding lugs (supplied with the receiver) through the top of the cabinet into the left-hand terminals of the antenna blocks (at the upper edge of the receiver board) and secure them to the cabinet top with the screws provided (see Detail B).
3. Insert the receiver's antennas through the top of the cabinet, into the blocks' right-hand terminals, and tighten the screws.



**Figure 3. Mounting the PC Board and RF Receiver**

**Auxiliary Device Current Draw Worksheet**

| DEVICE   | CURRENT       | No. UNITS      | TOTAL CURRENT |
|--|---------------|----------------|---------------|
| 6150 Fixed-Word Keypad                                 | 40mA/70mA**   |                |               |
| 6160 Alpha Keypad                                      | 40mA/150mA**  |                |               |
| 6150V Fixed-Word Display Voice Keypad                  | 60mA/160mA**  |                |               |
| 6160V Alpha Display Voice Keypad                       | 60mA/190mA**  |                |               |
| 6280 Touch Screen Keypad                               | 140mA/255mA** |                |               |
| Tuxedo Touch   | 140mA/260mA** |                |               |
| Tux-WiFi   | 140mA/260mA** |                |               |
| 5881/5882 RF Receiver                                  | 60mA          |                |               |
| 5883H Transceiver                                      | 80mA          |                |               |
| 4219 Zone Expander                                     | 30mA          |                |               |
| 4204 Relay Unit  | 15/180mA‡     |                |               |
| 4229 Zone Expander/Relay Unit                          | 30/100mA‡     |                |               |
|  |               |                |               |
|  |               |                |               |
|  |               |                |               |
| (Current available from Aux. terminals = 600 mA max.)† |               | <b>TOTAL =</b> |               |

\*If using hardware devices such as PIRs, refer to the specifications for that particular unit's current draw.  
 \*\* Values are for standby/alarm; alarm for keypads means armed with backlighting on and sounder on  
 †In UL installations, maximum current draw from the Auxiliary Output and the Alarm Output **combined** must not exceed 600 mA (500 mA max from Aux. Output).  
 ‡Values are for relays OFF/relays ON.

**CALIFORNIA STATE FIRE MARSHALL (CSFM) AND UL RESIDENTIAL FIRE 24-HOUR BATTERY BACKUP REQUIREMENTS**

The California State Fire Marshal and UL have regulations which require that all residential fire alarm control panels must be provided with a backup battery which has sufficient capacity to operate the panel and its attached peripheral devices for 24 hours in the intended standby condition, followed by at least 4 minutes in the intended fire alarm signaling condition. This control panel can meet these requirements without using a supplementary power supply, provided that the panel's auxiliary power and bell output currents are limited as indicated below.

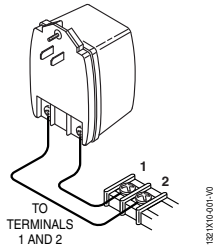
| OUTPUT LIMITATIONS AND CORRESPONDING REQUIRED BATTERIES          |                           |                                   |                                       |
|--|---------------------------|-----------------------------------|---------------------------------------|
| OUTPUT CURRENT LIMITATIONS                                       |                           | BATTERY INFORMATION               |                                       |
| Output Current Total   | Maximum Auxiliary Current | Battery Capacity To Use (Amp/Hrs) | Recommended Battery (Yuasa Model No.) |
| 600mA maximum total of auxiliary power plus bell output currents | 45mA                      | 4AH                               | NP4-12 (or ADEMCO 467)                |
|  | 160mA                     | 7AH                               | NP7-12                                |
|  | 200mA                     | 8AH                               | NP4-12 (two) ‡                        |
|  | 425mA                     | 14AH                              | NP7-12 (two) ‡                        |
|  | 500mA                     | 18AH‡‡                            | NPG18-12                              |

‡ **NOTE:** Use two batteries, connected in parallel. Obtain Battery Harness Kit 100-02111. (Both batteries will fit inside the cabinet).  
 ‡‡ 18AH must be mounted in a separate cabinet.



## AC Power, Battery, and Ground Connections

### 1321 Transformer



Connect the 1321 Transformer (1321CN in Canada) to terminals 1 and 2 on the control board. See Wire Run Chart for wire size to use.

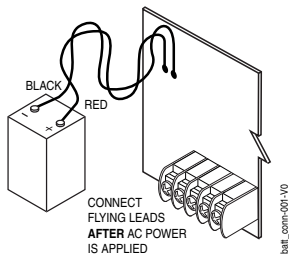
### Wire Run Chart

| Distance from control | Wire Size |
|-----------------------|-----------|
| Up to 50 feet         | # 20      |
| 50–100 feet           | # 18      |
| 100-250 feet          | # 16      |

- Use caution when wiring the transformer to the control to guard against blowing the transformer fuse (the fuse is non-replaceable).

- Wiring to the AC transformer must not exceed 250 feet using 16 gauge wire. The voltage reading between terminals 1 and 2 of the control must not fall below 16.5VAC or an “AC LOSS” message will be displayed.
- **Do not plug the transformer into the AC outlet** until all wiring connections to the control are complete. As a safety precaution, always power down the control when making such connections.

### Battery Connections



1. Place the 12-volt backup battery in the cabinet.
2. After all connections to the control are completed and AC power has been applied, connect the red and black flying leads on the control board to the battery. Do not attach these leads to the battery terminals until all connections are completed.

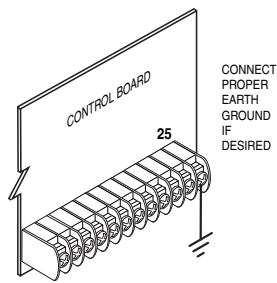
**UL** For UL installations and Residential fire installations, refer to the chart on page 2-2 at left for the correct battery size required to meet the mandatory standby time.

### Battery Saver Feature

The battery will disconnect from the system after its voltage decreases below 9VDC. This assists the control panel in recharging the battery when AC is restored.

**IMPORTANT:** The panel will not power up initially on battery power only. You must plug the transformer in first, and then connect the battery.

### Earth Ground



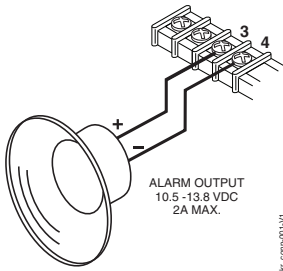
- This product has been designed and laboratory-tested to ensure its resistance to damage from generally expected levels of lightning and electrical discharge, and does not normally require an earth ground.
- If an earth ground is desired for additional protection in areas of severe electrical activity, terminal 25 on the control board, or the cabinet, may be used as the ground connection point (use minimum 14AWG wire). The following are examples of good earth grounds available at most installations.

**Metal Cold Water Pipe:** Use a non-corrosive metal strap (copper is recommended) firmly secured to the pipe to which the ground lead is electrically connected and secured.

**AC Power Outlet Ground:** Available from 3-prong, 120VAC power outlets only. To test the integrity of the ground terminal, use a 3-wire circuit tester with neon lamp indicators, such as the UL Listed Ideal Model 61-035, or equivalent, available at most electrical supply stores.

## Sounder (Bell) Connections

### Basic Connections



1. Make sounder connections to alarm output terminals 3 (+) and 4 (-).
  2. If not using bell supervision, connect the supplied 820 ohm resistor across terminals 3 and 4. If using bell supervision, see Supervised Output paragraph below.
- The 12VDC sounder output activates when an alarm occurs.
  - Total current drawn from this output cannot exceed 2 amps (going beyond 2 amps will overload the power supply, or may cause the electronic circuit protecting the sounder output to trip).
  - You must install a battery, since the battery supplies this current.

### Supervised Output

1. Connect the supplied 820 ohm Bell Supervision EOL resistor across the terminals of the last sounder. See Figure 5.

**Bell Supervision Note:** The value of the Bell Supervision EOL Resistor is 820 ohms.

**High Impedance Device Note:** If a high impedance sounding device is used (ex. 745X3), the bell supervision resistor (included) must be installed at the device.

2. Set field \*91 Option Selection for Bell Supervision (option 1).

This control complies with NFPA requirements for temporal pulse sounding of fire notification appliances. Temporal pulse sounding for a fire alarm consists of: 3 pulses – pause – 3 pulses – pause – 3 pulses–etc.

### UL

- Use only UL Listed sounding devices for UL installations.
- Bell supervision is required for fire alarm installations.
- The total current drawn from the alarm output and the auxiliary power output, combined, cannot exceed 600mA. In addition, the sounding device must be a UL Listed audible signal appliance rated to operate in a 10.5-13.8VDC voltage range, and must be mounted indoors.

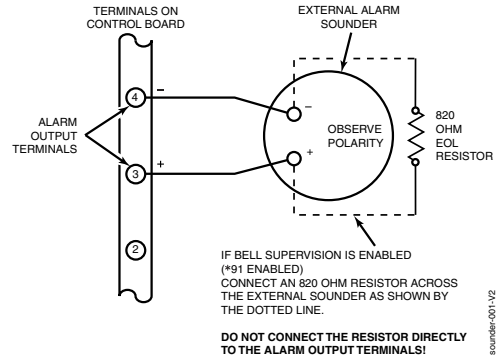
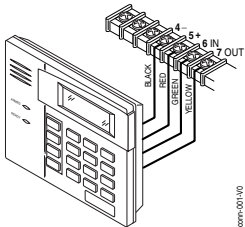


Figure 5. Sounder Wiring (Supervised)

## Connecting the Keypads and Other Addressable Devices

### Connections



Connect keypads and other addressable devices (4204, 4219, 4229, 5881, GSMV4G, etc.) to the control's keypad terminals as shown on the Summary of Connections diagram. The system supports up to 8 keypads, which can be assigned to partitions in any combination (see program fields \*190.\*196).

Use the Table of Device Addresses to determine the appropriate address for each device.

Determine wire size using the Wire Run Chart on the following page. For single 4-wire runs, determine the current drawn by all units, then refer to the Wiring Run chart to determine the maximum length that can be safely used for each wire size.

### Supplementary Power (optional)

**UL** Use a UL Listed, battery-backed supply for UL installations. The battery supplies power to these keypads in case of AC power loss. The battery-backed power supply should have enough power to supply the keypads with the UL required minimum standby power time.

Use supplementary power if the control's aux. power load for all devices exceeds 600mA (suggested power supply: AD12612). Connect as shown in Figure 6. Be sure to connect the negative (-) terminal on the power supply unit to terminal 4 (AUX -) on the control.

**IMPORTANT:** Keypads powered from supplies that do not have a backup battery will not function if AC power is lost. Make sure to power at least one keypad in each partition from the control's auxiliary power output.

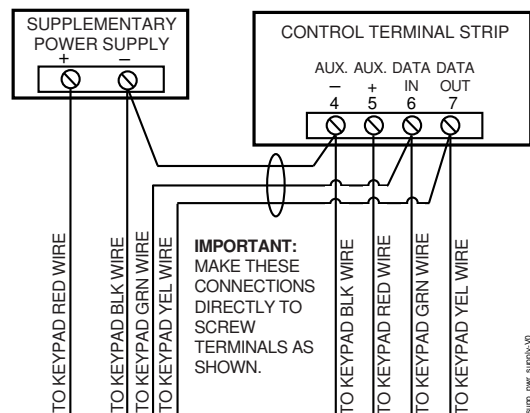


Figure 6. Using a Supplementary Power Supply

**Keypad Notes**



Set device addresses. Refer to the instructions included with the devices and set each address according to the **Table of Device Addresses**.

See data fields \*190-\*196 in the **Programming Guide** for details on enabling keypad addresses, assigning keypad partitions, and selecting keypad sounding options.

**IMPORTANT:** Each keypad must be assigned a unique, predefined address, **from 16 to 23. The first keypad is address 16** (default = partition 1, all sounds enabled).

**TOUCH SCREEN KEYPAD (AUI) NOTES:**

- Use of AUI devices (e.g., 6280, Tuxedo) is independent from standard keypads and does not affect the number of standard keypads the system can support.
- AUI devices must be set for address 1, 2, 5\*\*, or 6\*\* depending on which unit is enabled in field \*189. \*\* VISTA-20P series

**Communication Device (Long Range Radio) Connections**

Connect the data in/data out terminals and voltage input terminals of the communication device to the control's keypad connection points.

Set the device's address to "03" following the instructions provided with the device.

- Use a compatible communication device (e.g., GSMV4G, GSMX4G, IGSMV4G).

| Wire Run Chart For Devices* Drawing Aux Power From The Control (12V+ & 12V-) |   |                |               |               |              |
|--|---|----------------|---------------|---------------|--------------|
| Wire Size  | TOTAL CURRENT DRAWN BY ALL DEVICES CONNECTED TO A SINGLE WIRE RUN |                |               |               |              |
|  | 50 mA or less   | 100 mA         | 300 mA        | 500 mA        | 600 mA       |
| #22  | 900 ft (274m)   | 450 ft (137m)  | 150 ft (46m)  | 90 ft (27m)   | 75 ft (23m)  |
| #20  | 1400 ft (427m)  | 700 ft (213m)  | 240 ft (73m)  | 140 ft (43m)  | 120 ft (37m) |
| #18  | 1500 ft (457m)  | 1100 ft (335m) | 350 ft (107m) | 220 ft (67m)  | 170 ft (52m) |
| #16  | 1500 ft (457m)  | 1500 ft (457m) | 550 ft (168m) | 350 ft (107m) | 270 ft (82m) |

\* Includes Keypads, RF Receivers, Zone Expander/Relay Units, and Communication Device.

Maximum wire lengths for any device that is homerun to the control can also be determined from the Wiring Run Chart, based on the current draw of that device alone.

The length of all wire runs for both partitions combined must not exceed 1500 feet (457m) when unshielded quad conductor cable is used (750 feet if shielded cable is used). This restriction is due to the capacitive effect on the data lines when quad cable is used.

**Table of Device Addresses**

| This Device                  | Uses Address | Reports as†† | Enabled By...  |
|------------------------------|--------------|--------------|--|
| RF Receiver                  | 00           | 100          | *56 zone programming: input device type entry                |
| AUI 1 (touchscreen)          | 01           |              | automatic if AUI enable field *189 enabled for AUI 1         |
| AUI 2 (touchscreen)          | 02           |              | automatic if AUI enable field *189 enabled for AUI 2         |
| AUI 3 (touchscreen) (V20P)   | 05           |              | automatic if AUI enable field *189 enabled for AUI 3         |
| AUI 4 (touchscreen) (V20P)   | 06           |              | automatic if AUI enable field *189 enabled for AUI 4         |
| Communication Device (LRR)   | 03           | 103          | automatic if communication device is enabled in field *29    |
| Zone Expanders (4219/4229):  |              |              | *56 zone programming: input device type, entry 2, then:      |
| module 1 (for zones 09 - 16) | 07**         | 107          | automatic if zone no. 9-16 set as AW type or relay assigned  |
| module 2 (for zones 17 - 24) | 08           | 108          | automatic if zone no. 17-24 set as AW type or relay assigned |
| module 3 (for zones 25 - 32) | 09†          | 109          | automatic if zone no. 25-32 set as AW type or relay assigned |
| module 4 zones 33 - 40       | 10†          | 110          | automatic if zone no. 33-40 set as AW type or relay assigned |
| module 5 zones 41 - 48       | 11†          | 111          | automatic if zone no. 41-48 set as AW type or relay assigned |
| Relay Modules (4204):        |              |              | *79 output device programming: device address prompt:        |
| module 1                     | 12           | 112          | entered at device address prompt                             |
| module 2                     | 13           | 113          | entered at device address prompt                             |
| module 3                     | 14†          | 114          | entered at device address prompt                             |
| module 4                     | 15†          | 115          | entered at device address prompt                             |
| Keypads:                     |              |              | data field programming as listed below:                      |
| keypad 1                     | 16           | n/a          | always enabled for partition 1, all sounds enabled.          |
| keypad 2                     | 17           | n/a          | data field *190  |
| keypad 3                     | 18           | n/a          | data field *191  |
| keypad 4                     | 19           | n/a          | data field *192  |
| keypad 5                     | 20           | n/a          | data field *193  |
| keypad 6                     | 21           | n/a          | data field *194  |
| keypad 7                     | 22           | n/a          | data field *195  |
| keypad 8                     | 23           | n/a          | data field *196  |
| RIS Communication            | 25           | n/a          | automatic  |

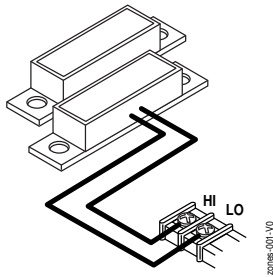
\*\* address 07 not available if zone-doubling enabled

† 4219/4229 addresses 9-11 and 4204 addresses 14-15 apply to the VISTA-20P.

†† Addressable devices are identified by "1" plus the device address when reporting. Enter report code for zone 91 to enable addressable device reporting (default = reports enabled). See field \*199 for addressable device 3-digit/2-digit identification keypad display options.

## Hardwire Zones and Zone Expansion

### Hardwire Zones



#### Normally Open Zones/ N.O. EOLR Zones

1. Connect open circuit devices in parallel across the loop; for EOLR zones, connect the EOLR across the loop wires at the last device.
2. Enable normally open/EOLR zones using Zone Programming mode, “Hardwire Type” prompt.

#### Normally Closed Zones/ N.C. EOLR Zones

1. Connect closed circuit devices in series in the high (+) side of the loop; for EOLR zones, connect the EOLR in series following the last device.
2. Enable normally closed/EOLR zones using Zone Programming mode, “Hardwire Type” prompt.

#### End of Line Resistor (EOLR) Notes

- If the EOLR is not at the end of the loop, the zone is not properly supervised and the system may not respond to an “open” on the zone.
- Zone 1 is intended for EOLR only.

**UL** For UL commercial burglar alarm installations, use EOLR zones.

### Double-Balanced Zones (V20P only)

Connect as shown below (resistor provided for one device).

**IMPORTANT:** Double-balanced zones provide zone tamper protection, and should be used as burglary zones only.

**Do not use double-balanced zones as fire zones.**

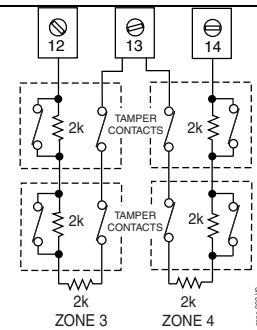


Fig. 7. Typical Double Balanced Zones

### Zone Doubling (V20P only)

This feature provides two hardwired normally closed zones for each standard hardwired zone connected to the control’s terminals (but does not increase the total number of zones supported by the control). If enabled (Zone Programming mode, “Hardwire Type” prompt, option “3”), hardwire zones are automatically paired as shown in the table. Connect as shown (resistors supplied; use 3k and 6.2k 5%, 1/4W or bigger resistors).

- **Do not use zone doubling for fire zones.**

**NOTE:** A short across the EOL (i.e., at terminal) on either zone of a zone-doubled pair or on a double-balanced zone causes a tamper condition (displayed as CHECK plus zone numbers).

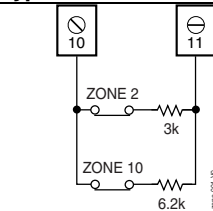
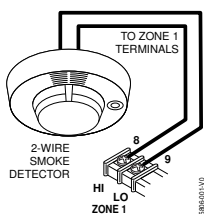


Fig. 8. Typical Zone Doubling Wiring

| Zone Doubling Table |                  |
|---------------------|------------------|
| Zone                | Paired with zone |
| 2                   | 10               |
| 3                   | 11               |
| 4                   | 12               |
| 5                   | 13               |
| 6                   | 14               |
| 7                   | 15               |
| 8                   | 16               |

**NOTE:** Zone numbers used for zone doubling cannot be used for anything else (ex. cannot be used for 4219 zones)

### Smoke Detectors



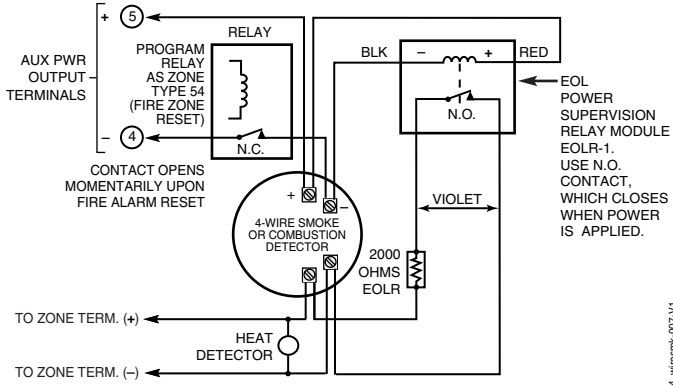
1. Connect up to 16 (10, if “clean me” option used) 2-wire smoke detectors across zone 1 terminals 8 (+) and 9 (-) as shown in the Summary of Connections diagram at the back this manual. Observe proper polarity when connecting the detectors.
2. Connect an EOL resistor across the loop wires at the last detector.
3. Connect 4-wire smoke detectors (number of detectors depends on detector current draw) to any zone from 2-8 as shown in Figures 9a and 9b (on next page).

**Power Reset:** This control does not automatically reset power to 4-wire smoke detector zones, so you must use a relay (e.g., 4204, 4229), or on-board trigger to reset power (also required for fire verification). Do this by programming the designated relay/trigger as zone type 54 (fire zone reset); see **On-Board Trigger** section for other information.

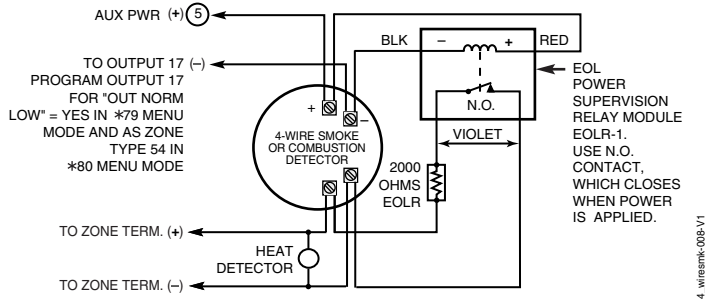
**NOTE:** Maximum current on trigger 17 is 100mA.

**Smoke Detector Notes**

- **Fire Verification (zone type 16):** The control panel will “verify” a fire alarm by resetting the smoke detectors after the first alarm trigger, and then waiting up to 90 seconds for a second alarm trigger. If the smoke detector or thermostat does not trigger again, the control will disregard the first trigger, and no alarm signal will occur. This feature eliminates false alarms due to electrical or physical transients.  
**SIA Installations:** If using fire verification on zones other than zone 1, UL Fire Alarm Listed relay accessories must be used to reset power as described in the Power Reset paragraph above.
- The zone 1 alarm current supports only one smoke detector in the alarmed state.
- **Clean Me Option:** If enabled (field \*174 = 1; \*56 zone programming, response time prompt = 3), certain ESL smoke detectors send “clean me” reports as appropriate. If used, the maximum number of detectors is reduced to 10 (not standard 16). Refer to the ESL documentation included with the smoke detector for information regarding compatibility with the clean-me option.
- Do not use 4-wire smoke detectors on zone 1.

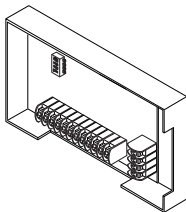


**Figure 9a. 4-Wire Smoke Detector Using Relay for Power Reset**



**Figure 9b. 4-Wire Smoke Detector Using Output 17 for Power Reset**

**4219/4229 Expansion Zones**



1. Connect each module to the control’s keypad terminals and set the device addresses. See the Table of Device Addresses to select an appropriate address for each module.
  - VISTA-20P: Up to 40 expansion zones using up to 5 Zone Exp. Modules.
  - VISTA-15P: Up to 16 expansion zones using up to 2 Zone Exp. Modules.
2. Connect sensors to the module’s loops.
  - Use appropriate end-of-line resistors (2k ohms) at the end of loops connected to the 4219/4229 modules.
  - Expansion zones have normal response time (300–500 msec), except zone connected to each module’s loop “A,” which can be set for fast response (10–15 msec).
3. If using relays with the 4229, connect the desired field wiring to the unit's relay contact terminals.

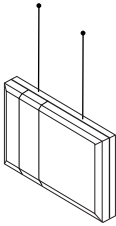
## Installing the RF Receiver and Wireless Transmitter Zones

### Compatible Receivers

Use any ADEMCO 5800 Series Wireless Receivers, such as:

| RF Receiver               | No. of Zones  |
|---------------------------|---|
| 5881ENL/5882L             | up to 8   |
| 5881ENM/5882M,<br>6150RF  | up to 16  |
| 5881ENH,<br>5883H, 6160RF | VISTA-20P = up to 40 plus 16 buttons<br>VISTA-15P = up to 26 plus 8 buttons |

### Receiver Connections



1. Set Device Address to "00" (set all switches to the right, "off" position).
2. Mount the receiver, noting that the RF receiver can detect signals from transmitters within a nominal range of 200 feet.
3. Connect the receiver's wire harness to the control's keypad terminals. Plug the connector at the other end of the harness into the receiver. Refer to the installation instructions provided with the receiver for further installation procedures regarding antenna mounting, etc.

#### WIRELESS ZONE NUMBERS

VISTA-20P:  
transmitter zones 9-48  
button zones 49-64

VISTA-15P:  
transmitter zones 9-34  
button zones 49-56

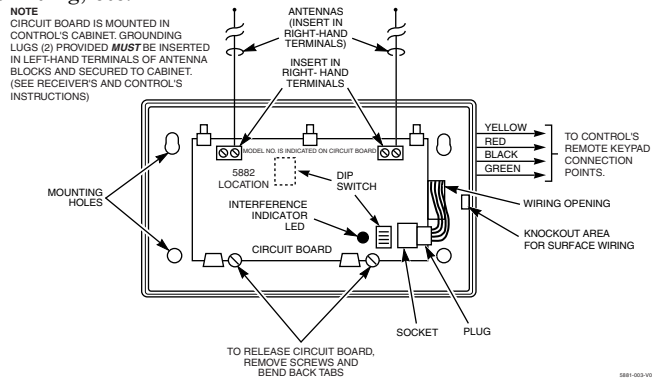


Figure 10. 5881/5882 RF Receiver (cover removed)

### RF Receiver Notes

† These fields must be enabled for Residential Fire, UL Residential Burglar Alarm, and UL Commercial Burglar Alarm installations.

Set the following options:

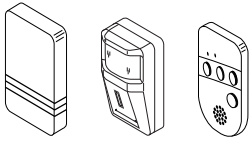
- \*22 RF Jam Option†
- \*24 RF House ID Code (if using wireless keypads) for each partition
- \*67 Transmitter Low Battery Report Code†
- \*75 Transmitter Low battery restore report code†

• The receiver is supervised and a trouble report is sent ("CHECK 100" displayed) if communication between the panel and receiver is interrupted, or if no valid RF signals from at least one supervised transmitter are received within 12 hours.

If the receiver is mounted remotely:

- Place the RF receiver in a high, centrally located area for best reception.
- Do not locate the receiver or transmitters on or near metal objects. This will decrease range and/or block transmissions.
- Do not locate the RF receiver in an area of high RF interference (indicated by frequent or prolonged lighting of the LED in the receiver; random flicker is OK).
- Do not locate RF receiver closer than 10 feet from any keypads to avoid interference from the microprocessors in those units.

**Installing the Transmitters**



- Refer to the table of compatible devices at the back of this manual.
- Supervised transmitters† send check-in signals to the receiver at 70-90 minute intervals. If at least one check-in message is not received from each transmitter within a 12-hour period, the “missing” transmitter number(s) and “CHECK XX” is displayed. († Hand-held transmitters, e.g., 5802, 5802CP, 5804, 5804BD, 5827, 5827BD, do not send check-in signals.)
- To be sure reception of the transmitter's signal at the proposed mounting location is adequate, perform a Go/No Go Test, described in the **Testing the System** section.
- Install transmitters in accordance with the instructions provided with each.
- Set 5827, 5827BD, 5804BD wireless keypads to the programmed House ID (field \*24), using its DIP switches (5827) or follow the instructions provided with the device.
- Use \*56 or \*58 Zone Programming Menu modes to program zone information and enroll transmitters (VISTA-20P: zones 9-48, buttons 49-64; VISTA-15P: zones 9-34, buttons 49-56).
- **Wireless Keys:** Use Wireless Key Programming Templates section of the \*58 Zone Programming Menu mode to program zone information and enroll each button of the wireless keys used. Once a wireless key is enrolled, it must be assigned to a user before it becomes active. See Adding/Deleting Security Codes section for procedure.

The RF supervision period for the VISTA-20PCN and VISTA-15PCN is three hours for Fire zones (Zone Type 9 and 16) and 12 hours for all other zone types.

**UL** The following transmitters are not intended for use in UL installations: 5802MN, 5802MN2, 5804, 5804BD, 5814, 5816TEMP, 5819, 5819WHS & BRS, and 5850.  
The 5827BD can be used in UL Listed Residential Burglar installations.

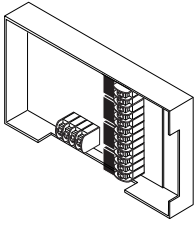
**Transmitter Battery Life**

- See Wireless Transmitter paragraph in the **Limitations of This Alarm System** statement located at the end of this manual for information on transmitter battery life.
- Some transmitters (e.g., 5802 and 5802CP) contain long-life but non-replaceable batteries, and no battery installation is required. At the end of their life, the complete unit must be replaced (and a new serial number enrolled by the control).
- Button-type transmitters (such as 5801, 5802, and 5802CP) should be periodically tested for battery life.
- The 5802MN and 5804 Button Transmitters have replaceable batteries.

Do not install batteries in wireless transmitters until you are ready to enroll during system programming. After enrolling, batteries need not be removed.

## Connecting Relay Modules and Output Triggers

### 4204/4229 Relay Modules



**UL** For UL installation requirements, refer to the Installation Instructions for the 4204.

1. Mount either remotely or in the control panel.
2. Connect each module to the control's keypad terminals and set the device addresses as previously described in the **Connecting Keypads and Other Addressable Devices** section. Use the connector harness supplied with the module. Use standard 4-conductor twisted cable for long wiring runs.  
 VISTA-20P: Up to 16 relays  
 VISTA-15P: Up to 8 relays
3. Connect the desired field wiring to the unit's relay contact terminals.
  - Supervision: 4204 and 4229 modules are supervised against removal. The module's device address is displayed as follows if a module is disconnected from the control's terminals, or if the module cover is removed and the tamper jumper is installed:  
 Alpha: CHECK xx Wire Expansion  
           FAULT xx Wire Expansion  
           ALARM xx Wire Expansion  
 Fixed-Glass: lxx (or 91 if field \*199 set for 2-digit display) where "xx" is the module's address.
  - If communication/tamper failure occurs on a device with zones wired to it, all zones on the device will be displayed in their respective partitions.

### On-Board Triggers

Connect field wiring to the desired trigger pin on the 8-pin trigger connector centrally located above the terminal strip.

- Use a 4-wire cable (N4632-4, not supplied) as shown below.

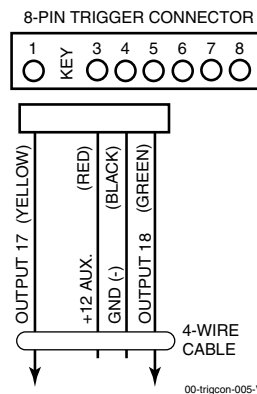


Figure 13b. On-Board Trigger Connector with 4-Wire Cable for Trigger Use Only

- Trigger outputs are normally high, and go low upon programmed condition.
- The outputs can be programmed for inverted operation (normally low, go high) using \*79 Menu mode.
- Program these triggers using \*80/\*81 Menu modes as you would for any other relay output.
- When using these outputs, note:
  - pin 1 = output number 17 (trigger 1):  
 15 ohms to ground when closed (output low), open when off (output high, normal default); can be used to reset smoke detector power (must set "output normal low = yes" in \*79 Menu mode, and set for zone type 54, fire zone reset, in \*80 Menu mode); or can support 12V relay module (e.g., Altronix AX-RBS) that draws less than 100mA
  - pin 5 = output number 18 (trigger 2):  
 100 ohms to ground when closed (output low); open when off (output high, normal default); or can support 12V relay module that draws less than 20mA

**UL** If on-board triggers are used, the wiring between the control unit and the UL Listed device must be run in conduit, be no more than 3 feet apart, and have no intervening barriers or walls.



## Phone Line and Audio Alarm Verification (AAV) Connections

### Phone Line

Connect incoming phone line and handset wiring to the main terminal block (via an RJ31X jack) as shown in the Summary of Connections diagram at the back of this manual.

Wire colors represent the colors of the cable to the RJ31X jack.

### Audio Alarm Verification Connections (UVS System)

#### Using the UVS System with UVCM Module

The UVS system provides audio alarm verification via the phone line.

- Refer to the connection diagram below.
- Connections use one of the on-board triggers.
- Set field \*91 for AAV and program the appropriate output (output 17 or 18) using \*80 Menu mode: select zone type 60 and output action 1 (close for 2 seconds).
- For voice session monitoring, connect an EOLR zone to UVCM module terminals 6 & 7, and program the zone as zone type 81 (\*56 Menu mode).

E.g., Using output 18 for the trigger, program an output function in \*80 Menu mode as:  
ZT = 60, P = 0, Action = 1, Device = 18

- Suggested AAV Module: ADEMCO UVS (shown) or Eagle 1250

**UL** UL installations using the AAV feature must use the ADEMCO UVCM module (part of the ADEMCO UVS system).

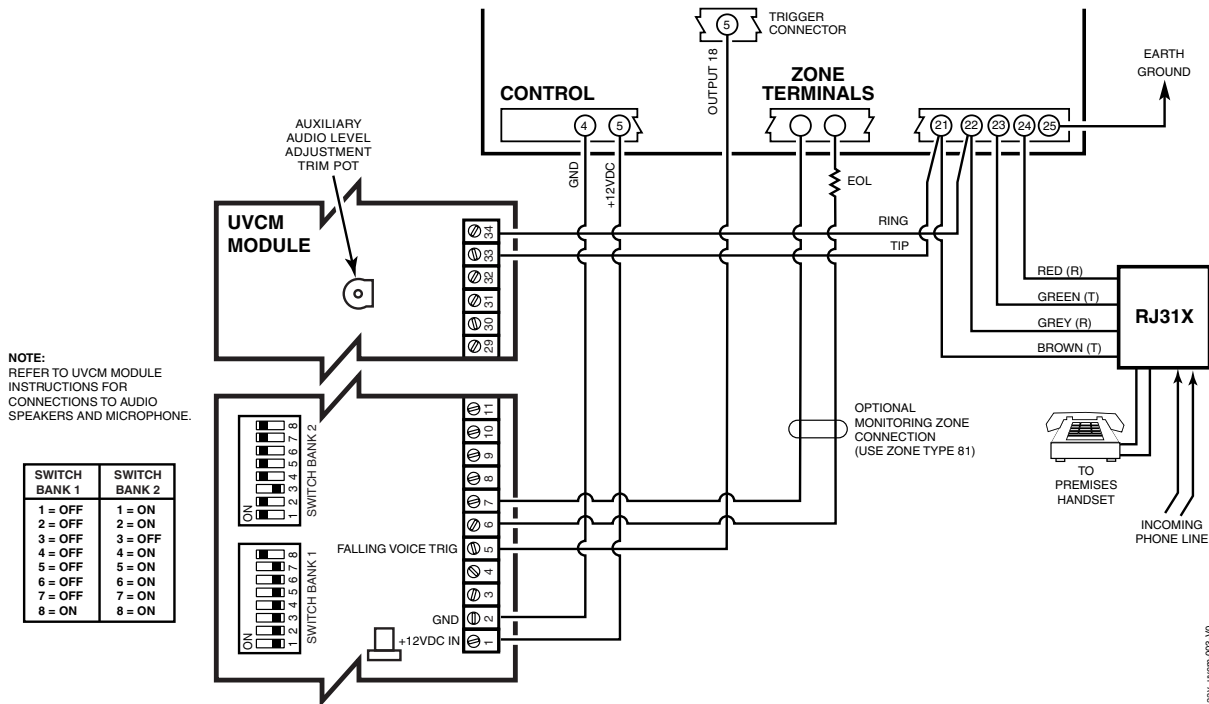


Figure 15. Connection of AAV Unit

**Audio Alarm Verification Connections (AVS System)**

**Using the AVS System with AVS Module and AVST Remote Stations**

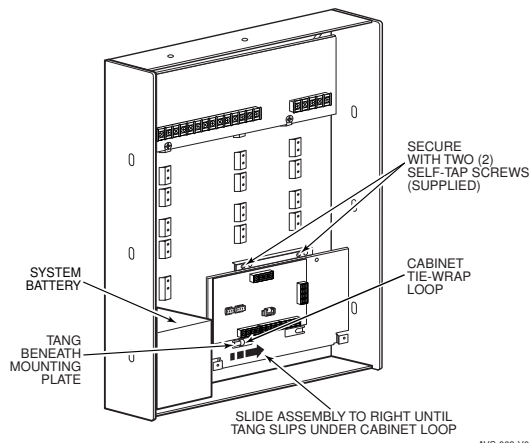
The AVS system provides audio alarm verification via the phone line or via AlarmNet if the GSMV4G or GSMX4G module is used as the communication device. Refer to the instructions included with the AVS system for installation procedures. The following is a summary.

**Mounting the AVS Base Unit**

As shipped, the AVS Base unit board comes pre-mounted on its mounting bracket, which is designed to mount inside the control cabinet.

Refer to the diagram at right.

- a. Position the mounting plate/PC board assembly in the bottom of the control's cabinet.
- b. Slide the mounting plate to the right so that the plate's left-hand tang slides under the cabinet's tie-wrap loop.
- c. Secure the assembly to the cabinet using the two self-tapping screws provided.



**BATTERY NOTE:** When using a 7AH battery, mount the battery vertically on the bottom left-hand side of the cabinet, with the terminals facing down and right (negative terminal closest to the PC board bracket).

**Wiring the AVS to the Control**

The AVS Base unit board has several terminal blocks for making connections to remote stations, telephone lines, and to the control panel. The AVS base unit connects to the control's ECP terminals, with all other ECP devices connecting to the AVS base unit ECP terminals. See the diagram on the next page for specific wiring connections.

**DIP Switch:** Set the AVS DIP switch to the appropriate address (V15P = 08; V20P = 11).

**IMPORTANT:** The AVS should be the only ECP device connected to the control's ECP terminals. Connect all other ECP devices (keypads, expander modules, etc.) to the ECP terminals on the AVS board.

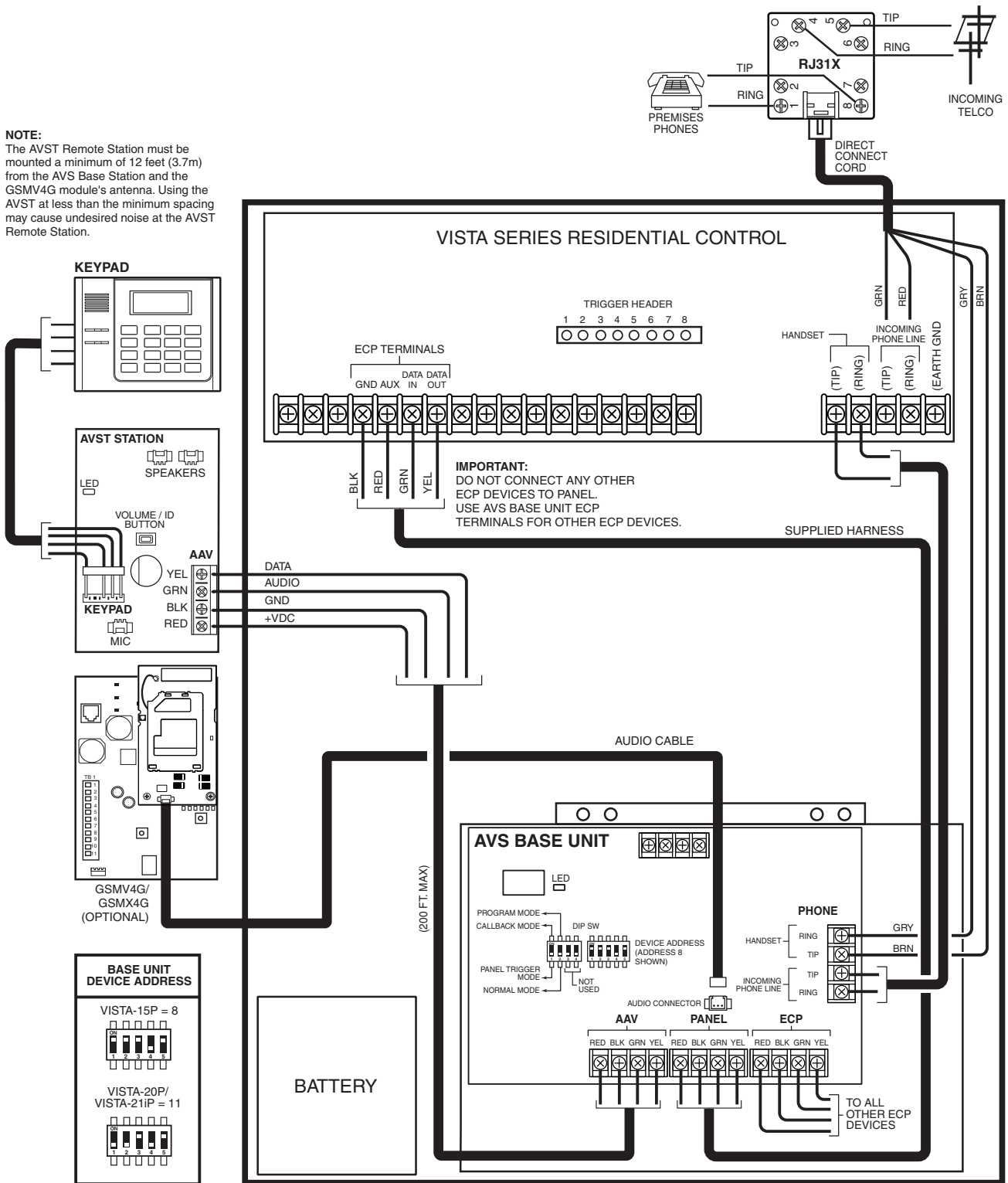
**Connecting an Optional GSMV4G/GSMX4G Module**

- a. If using a GSMV4G or GSMX4G module for 2-way voice operation, install the module according to its instructions. **NOTE:** The module must be mounted within three feet of the control.
- b. Connect the audio cable from the module to the Audio connector on the AVS board. The audio cable is supplied with the GSMV4G/GSMX4G module.
- c. Complete all other GSMV4G/GSMX4G wiring following the instructions included with that module.

The following summarizes the programming steps for AVS operation (refer to the Programming Guide for details of the AVS Quick Command options):

- a. Install the AVS module according to its instructions.
- b. Use one of the control's AVS Quick Program commands as follows :
  - **installer code + [#] + 03:** enable AVS operation without panel sounds on the AVST
  - **installer code + [#] + 04:** enable AVS operation and enable panel sounds on the AVST speaker
  - **installer code + [#] + 05:** remove all programming options set by [#] + 03 quick command
  - **installer code + [#] + 06:** remove all programming options set by [#] + 04 quick command
- c. Use data field \*55 Dynamic Signaling Priority to select the desired reporting paths.

**NOTE:**  
The AVST Remote Station must be mounted a minimum of 12 feet (3.7m) from the AVS Base Station and the GSMV4G module's antenna. Using the AVST at less than the minimum spacing may cause undesired noise at the AVST Remote Station.



AVS-001-V2

Figure 16. Connections for the AVS System



# System Communication and Operation

## Panel Communication with Central Station

This system accommodates several formats for reporting alarms and other system conditions to the Central Station. The process of a successful transmission consists of both the method of communication between the control panel and the Central Station receiver; and the actual way the information is sent and displayed at the Central Station.

When the panel calls the Central Station receiver, it waits to hear a “handshake” frequency from the receiver to confirm that the receiver is on-line and ready to receive its message. Once the panel hears the handshake it is programmed to listen for, it sends its message. The panel then waits for a “kissoff” frequency from the receiver acknowledging that the message was received and understood.

If the handshake frequency is not given or is not understood by the panel, the panel will not send its message. Once the handshake frequency is received and understood by the panel, the panel sends its message. If there is an error in the transmission (the receiver does not receive a “valid” message), the kissoff frequency is not given by the Central Station receiver.

The panel makes a total of eight attempts to the primary telephone number and eight attempts to the secondary telephone number (if programmed) to get a valid message through. If the panel is not successful after its numerous attempts, the keypad displays COMM. FAILURE (on alpha keypads) or FC (on fixed-word keypads).

## Report Code Formats

The following chart indicates the types of (handshake/kissoff) frequencies that the panel supports and the different formats that can be sent with each.

| FORMAT                      | HANDSHAKE    | TRANSMITS DATA | KISSOFF | TRANSMIT TIME                      |
|-----------------------------|--------------|----------------|---------|------------------------------------|
| Low Speed<br>3+1, 4+1, 4+2  | 1400 Hz      | 1900Hz (10PPS) | 1400 Hz | Under 15 secs<br>(Standard report) |
| Sescoa/Rad<br>3+1, 4+1, 4+2 | 2300 Hz      | 1800Hz (20PPS) | 2300 Hz | Under 10 secs<br>(Standard report) |
| Express<br>4+2              | 1400–2300 Hz | DTMF (10 cps)  | 1400 Hz | Under 3 secs                       |
| Contact ID                  | 1400–2300 Hz | DTMF (10 cps)  | 1400 Hz | Under 3 secs                       |

The following table describes each format in greater detail.

| FORMAT TYPE                           | DESCRIPTION  |
|---------------------------------------|--|
| 3+1 and 4+1<br>Standard Formats       | Comprises a 3- (or 4-) digit subscriber number and a single-digit report code (e.g., Alarm, Trouble, Restore, Open, Close, etc).   |
| 3+1 and 4+1<br>Expanded Formats       | Comprises a 3- (or 4-) digit subscriber number and a two-digit report code. The first digit is displayed on the first line. On the second line, it is repeated 3 (or 4) times and is followed by the second digit. This is the “expanded” digit. |
| 4+2 Format                            | Comprises a 4-digit subscriber number and 2-digit report code.   |
| ADEMCO Contact ID<br>Reporting Format | Comprises a 4- or 10-digit subscriber number (depending on format selected), 1-digit event qualifier (“new” or “restore”), 3-digit event code, and 3-digit zone number, user number, or system status number (see the following page).           |

The following table lists codes for reports sent in different formats:

| Type of Report | Code for 3+1/4+1 Standard | Code for 3+1/4+1 Expanded   | Code for 4+2                       |
|----------------|---------------------------|---|------------------------------------|
| Alarm          | SSS(S) A                  | SSS(S) A<br>AAA(A) Z  | SSSS AZ                            |
| Trouble        | SSS(S) T                  | SSS(S) T<br>TTT(T) t  | SSSS Tt                            |
| Bypass         | SSS(S) B                  | SSS(S) B<br>BBB(B) b  | SSSS Bb                            |
| AC Loss        | SSS(S) E                  | SSS(S) E<br>EEE(E) A <sub>C</sub>   | SSSS EA <sub>C</sub>               |
| Low Batt       | SSS(S) L                  | SSS(S) L<br>LLL(L) L <sub>B</sub>   | SSSS LL <sub>B</sub>               |
| Open           | SSS(S) O                  | SSS(S) O<br>OOO(O) U  | SSSS OU                            |
| Close          | SSS(S) C                  | SSS(S) C<br>CCC(C) U  | SSSS CU                            |
| Test           | SSS(S) G                  | SSS(S) G<br>GGG(G)g   | SSSS Gg                            |
| Restore Alarm  | SSS(S) R                  | SSS(S) R<br>RRR(R) Z  | SSSS RZ                            |
| AC Restore     | SSS(S) R <sub>A</sub>     | SSS(S) R <sub>A</sub><br>R <sub>A</sub> R <sub>A</sub> R <sub>A</sub> (R <sub>A</sub> )A <sub>C</sub> | SSSSR <sub>A</sub> A <sub>C</sub>  |
| LoBat Res.     | SSS(S) R <sub>L</sub>     | SSS(S) R <sub>L</sub><br>R <sub>L</sub> R <sub>L</sub> R <sub>L</sub> (R <sub>L</sub> )L <sub>B</sub> | SSSS R <sub>L</sub> L <sub>B</sub> |
| Trouble Res.   | SSS(S) R <sub>T</sub>     | SSS(S) R <sub>T</sub><br>R <sub>T</sub> R <sub>T</sub> R <sub>T</sub> (R <sub>T</sub> )t              | SSSS R <sub>T</sub> t              |
| Bypass Res.    | SSS(S) R <sub>B</sub>     | SSS(S) R <sub>B</sub><br>R <sub>B</sub> R <sub>B</sub> R <sub>B</sub> (R <sub>B</sub> )b              | SSSS R <sub>B</sub> b              |

**Where:**

- |   |   |
|---|---|
| SSS or SSSS = Subscriber ID                           | C = Close Code–1st Digit  |
| A = Alarm Code–1st digit                              | U = User Number (in hex)  |
| Z = Typically Zone Number*–2nd digit                  | Gg = Test Code (1st & 2nd digits)                                   |
| Tt = Trouble Code (1st & 2nd digits)                  | R = Restore Code (Alarm)  |
| Bb = Bypass Code (1st & 2nd digits)                   | R <sub>T</sub> t = Restore Code (Trbl) 1st & 2nd digits             |
| EA <sub>C</sub> = AC Loss Code (1st & 2nd digits)     | R <sub>B</sub> b = Restore Code (Byps) 1st & 2nd digits             |
| LL <sub>B</sub> = Low Battery Code (1st & 2nd digits) | R <sub>A</sub> A <sub>C</sub> = Restore Code (AC) 1st & 2nd digits  |
| O = Open Code–1st Digit                               | R <sub>L</sub> L <sub>B</sub> = Restore Code (Bat) 1st & 2nd digits |

\*Zone numbers for: \* & #, or B = 99; 1 + \*, or A = 95; 3 + #, or C = 96; Duress = 92

## Ademco Contact ID®

The Ademco Contact ID® Reporting Format comprises the following:

- 4-digit or 10-digit subscriber number (depending on format selected).
- 1-digit event qualifier (“new” or “restore”).
- 3-digit event code.
- 2-digit Partition No.
- 3-digit zone number, user number, or system status number (see below).

Ademco Contact ID® Reporting takes the following format: CCCC(CCCCC) Q EEE GG ZZZ

where: CCCC(CCCCC) =Customer (subscriber) ID

Q = Event qualifier, where: E = new event , and R = restore

EEE = Event code (3 hexadecimal digits)

**Note:** For a complete list of event codes, refer to the central office receiver manual.

GG = Partition Number (system messages show “00”)

ZZZ = Zone/contact ID number reporting the alarm, or user number for open/close reports. System status messages (AC Loss, Walk Test, etc.) contain zeroes in the ZZZ location.

**TABLE OF CONTACT ID EVENT CODES**  
(some event codes may not apply to certain control panels)

| Code | Definition                            |
|------|---------------------------------------|
| 110  | Fire Alarm                            |
| 121  | Duress                                |
| 122  | Alarm, 24-hour Silent                 |
| 123  | Alarm, 24-hour Audible                |
| 131  | Alarm, Perimeter                      |
| 132  | Alarm, Interior                       |
| 134  | Alarm, Entry/Exit                     |
| 135  | Alarm, Day/Night                      |
| 143  | Alarm, Expansion Module               |
| 145  | ECP Module cover tamper               |
| 146  | Silent Burglary                       |
| 150  | Alarm, 24-Hour Auxiliary/Monitor zone |
| 162  | Carbon Monoxide                       |
| 301  | AC Power                              |
| 302  | Low System Battery/Battery Test Fail  |
| 305  | System Reset (Log only)               |
| 321  | Bell/Siren Trouble                    |
| 333  | Trouble, Expansion Mod. Supervision   |
| 341  | Trouble, ECP Cover Tamper             |
| 344  | RF Receiver Jam                       |
| 351  | Telco Line Fault                      |
| 353  | Long Range Radio Trouble              |
| 354  | Failure to Communicate                |
| 373  | Fire Loop Trouble                     |
| 374  | Exit Error Alarm                      |
| 380  | Global Trouble, Trouble Day/Night     |

| Code      | Definition   |
|-----------|--|
| 381       | RF Sensor Supervision  |
| 382       | Supervision Auxiliary Wire Zone  |
| 383       | RF Sensor Tamper   |
| 384       | RF Sensor Low-battery  |
| 393       | Clean Me   |
| 401       | Disarmed, Armed AWAY, Armed MAXIMUM  |
| 403       | Schedule Arm/Disarm AWAY   |
| 406       | Cancel by User   |
| 407       | Remote Arm/Disarm (Downloading)  |
| 408       | Quick Arm AWAY   |
| 409       | Keypad Arm/Disarm AWAY   |
| 441       | Disarmed/Armed STAY/INSTANT, Quick-Arm STAY/INSTANT  |
| 442       | Keypad Arm/Disarm STAY   |
| 455       | Scheduled Arm Fail   |
| 459       | Recent Closing (SIA panels only)   |
| 570       | Bypass   |
| 601       | Manually Triggered Dialer Test   |
| 602       | Periodic Test  |
| 606       | AAV to Follow  |
| 607       | Walk Test Entered/Exited   |
| 623       | Event Log 80% Full   |
| 625       | Real-Time Clock was Changed (log only)   |
| 627       | Program Mode Entry (log only)  |
| 628       | Program Mode Exit (log only)   |
| 642       | Latch Key (log only)   |
| 750 - 789 | Reserved for Configurable Zone Type report codes (check with central station when using these codes) |

## Uploading/Downloading via the Internet

**UL:** Up/downloading via the Internet has not been evaluated by UL.

This control, when used with a compatible Internet/Intranet Communication Device, supports upload/download programming capability via the Internet using the AlarmNet network or, depending on the communication module used, a Private local area network (Intranet). This allows site maintenance independent of central station monitoring, and modification to sites globally via the Internet. Depending on the module used, Internet connection from the protected premises is either via high speed (broadband) cable or phone service, or via the GSM/GPRS digital cellular network (GSM modules).

Refer to the instructions provided with the communication module for information regarding its installation, programming, and registration. The System Requirements table below lists two sets of system requirements, depending upon whether you intend to communicate over the Internet or whether you are communicating over a Private LAN (Intranet).

**Compatible Communication Modules:** The following modules support Internet uploading/downloading, but future modules may also provide Internet upload/download support; refer to the module's instructions for compatibility. Compatible Modules: GSMV4G, GSMX4G, etc.

### System Requirements

| Internet Communication   | Intranet (Private LAN) Communication, if applicable*   |
|--|--|
| <p>At the Installation Site:</p> <ul style="list-style-type: none"> <li>• Appropriate Internet Communication Module</li> <li>• 7720P Programmer</li> <li>• Broadband Internet Access (for wired modules)</li> <li>• Broadband (Cable/DSL) Modem (for wired modules)</li> <li>• Broadband (Cable/DSL) Router (for wired modules if connecting more than one device to the Internet)</li> <li>• IP compatible Control Panel</li> </ul> <p>At the Downloading Office:</p> <ul style="list-style-type: none"> <li>• Broadband Internet Access</li> <li>• Broadband (Cable/DSL) Modem</li> <li>• Broadband (Cable/DSL) Router (optional, if connecting more than one device to the Internet)</li> <li>• Computer running Compass Downloading Software version that supports Internet upload/download for this control.</li> </ul> | <p>At the Installation Site:</p> <ul style="list-style-type: none"> <li>• Internet/Intranet Communication Module</li> <li>• 7720P Programmer</li> <li>• Ethernet Network Connection</li> <li>• IP compatible Control Panel</li> </ul> <p>At the Downloading Office:</p> <ul style="list-style-type: none"> <li>• 7810iR-ent IP Receiver</li> <li>• Internal Router</li> <li>• Computer(s) running the following software:                             <ul style="list-style-type: none"> <li>- Compass Downloading Software version that supports IP upload/download for this control.</li> <li>- Compass Connect Data Server Application</li> <li>- Compass Connect Control Server Application</li> </ul> </li> </ul> <p>* see module's instructions for applicability for LAN usage (ex. 7845i-ent supports LAN)</p> <p><b>NOTE:</b> Compass, the Compass Connect Data Server, and the Compass Connect Control Server applications may all be installed on the same computer if desired. If they are installed on one computer, the computer must have a fixed IP Address.</p> |

### To set up the control panel, do the following:

1. Connect the module to the control panel's ECP (keypad) terminals.
2. Internet Users: For wired modules, connect the module to the Internet via a cable/DSL modem and router. Intranet Users: Connect the module to the Intranet (LAN) via the appropriate Ethernet connection.
3. Enable the module in the control panel (using \*29 Menu mode) to enable alarm reporting and module supervision.
4. Using the module's programming menus (via \*29 Menu mode or 7720P programmer), program the communication device module for address 3 and program the module's other options as required.
5. Register the module with AlarmNet. The module must be registered before downloading or alarm reporting can take place.

### To perform upload/download functions:

1. Connect the computer to the Internet and start the Compass downloading software.
2. Open the control's account, then select the Communications function and click the **Connect** button.
3. At the Connect screen, check that the control's MAC address is entered and the TCP/IP checkbox is checked.
4. Click **Connect**. The Internet connection to the control is made automatically via AlarmNet.
5. Once connected, use the Compass downloading software as normal to perform upload/download functions.



## System Security Codes

The systems provides one Installer code, one System Master code, plus a set of other user codes intended for other users of the system. These codes can each be assigned one of 5 authority levels, which determine the functions each code can perform as listed in the table below.

VISTA-20P: Provides 48 security codes (plus Installer code), including one System Master code, two Partition Master codes, and 45 general user codes.

VISTA-15P: Provides 32 security codes (plus Installer code), including one System Master code and 31 general user codes.

**Authority Levels** (can be assigned to users 03-49 only; users 1 and 2 cannot be changed)

| Level                      | User No.                     | Functions   |
|----------------------------|------------------------------|---|
| Installer                  | 01                           | (default=4112) perform all security functions except can disarm only if used to arm; can enter program mode; can change System Master code; cannot assign other user codes<br>NOTE: For security purposes, the factory default installer code should be changed.                        |
| System Master              | 02                           | (default 1234) only one system master code per system; can perform all security functions, add/delete users in either partition, change system master code, view event log, set system clock, program keypad macro, program scheduled events, activate output devices (triggers/relays) |
| Partition Master (default) | P1 = 03<br>P2 = 33           | VISTA-20P. Same as Master, except add/delete users limited to assigned partition only, (these users can be assigned different authority levels, if desired; any user can be assigned the partition master authority level)  |
| 0-User                     | 03-49 (V20P)<br>03-33 (V15P) | perform security functions (arm, disarm, etc.) only; cannot add/delete users, view event log, set system clock or program scheduled events  |
| 1-Arm Only                 | see "user"                   | arm system only   |
| 2-Guest                    | see "user"                   | can disarm the system only if it was used to arm the system   |
| 3-Duress                   | see "user"                   | performs security functions, but also silently sends a duress message to the central station; reports as duress code user number.   |
| 4-Partition Master         | see "user"                   | VISTA-20P. See Partition Master paragraph above; used to assign other user numbers as partition masters   |

Refer to the user guide for procedures on adding/deleting security codes and changing user attributes. The following is a brief description of how to add user codes.

### Changing the System Master code:

Using Installer code: Installer code + [8] + 02 + new code

Using current System Master code: System Master code + [8] + 02 + new code + new code again

**Adding a User Code:** Master code + [8] + 2-digit user no. + user's code

**Deleting a User Code:** Master code + [8] + 2-digit user no. + [#] [0]

**Assigning Attributes:** Master code + [8] + 2-digit user no. + [#] [attribute no.] + value

#### Attributes:

#### Values

1 = Authority Level 0-4 (see Authority Level table above)

2 = Access Group 0-8 (0 = not assigned to a group)

3 = Active Partition(s) 1, 2, 3 (common)

for this user;

4 = RF Zone No.

Enter partitions consecutively if used and press [#] to end the entries.

Assigns user number to button type zone for arm/disarm (**keyfob must be enrolled in system first**; see *Wireless Key Templates* section in the **Programming Guide**).

**Deactivating a key fob:** You can deactivate the arming/disarming functions for a key fob (ex. if lost or stolen) by deleting the associated key fob user. See "Delete a User" above. Other key fob functions such as panic or device activation (if programmed) remain active. To fully remove the programming for a key fob, delete the zone(s) associated with the keyfob functions.

#### IMPORTANT SECURITY NOTICE

Please inform the User about the security importance of their key fob, and what to do if it is lost.

Explain that the key fob is similar to their keys or access card. If lost or stolen, another person can compromise their security system. They should immediately notify the Dealer/Installer of a lost or stolen key fob. The Dealer/Installer will then remove the key fob programming from the security system.

5 = Open/Close Paging 1 for yes, 0 for no

## Keypad Functions

The following is a brief list of system commands. For detailed information concerning system functions, refer to the User's Manual. For Touch Screen style keypad users, refer to the separate Touch Screen keypad (AUI) User's Guide.

### Voice Keypads

The 6150V/6160V Voice Keypads provide the following features:

- Message Center, which lets the user record and playback one message.
- Voice Status, which can announce system status by using the STATUS key.
- Voice Chime, which can alert users to the opening of doors/windows while the system is disarmed.

Refer to the User Guide for specific procedures for activating and using these features.

### Keypad Commands

| Function                               | Description   |
|--|---|
| Silence Burglary Alarms                | Pressing any key will silence the keypad sounder for 10 seconds. Disarming the system (security code + OFF) silences both keypad and external sounders.   |
| Silence Fire or Carbon Monoxide Alarms | Press the OFF [1] key to silence the keypad sounder and, for fire alarms, the external sounder. The detector sounding stops when the contaminated air is cleared from the detector; see the detector's instructions for further information.  |
| Quick Arm                              | If enabled (field *21), you can press [#] in place of the system's security code, plus the desired arming key (Away, Stay, Instant, Maximum)  |
| Single-Button arming                   | If programmed (*57 Function Key menu mode), lettered keys A-D can be used for arming, using options 3-AWAY, 4-STAY, 5-NIGHT-STAY, or 6-Step-Arming<br>If used, no security code is required to arm the system.  |
| Alarm Memory                           | When the system is disarmed, any zones that were in an alarm condition during the armed period will be displayed. To clear this display, simply repeat the disarm sequence (enter the security code and press the OFF key) again.   |
| Arming Away                            | Enter code + AWAY [2] or simply press appropriate lettered key on the keypads (see "Single-Button Arming" above). If the "Auto-Stay Arm" feature is enabled (field *84) and the entry/exit door is <b>not</b> opened and closed within the programmed exit delay time, the system will automatically arm in STAY mode if armed from a wired keypad (non-RF device). If the door is opened and closed within the exit delay period, the system arms in AWAY mode.          |
| Arming Stay                            | Enter code + STAY [3] or simply press appropriate key on the keypads (see "Single-Button Arming" above). See "Arming Away" above for Auto-Stay arming feature.  |
| Arming Night-Stay                      | Enter code + STAY [3] + STAY [3] or simply press appropriate key on the keypads (see "Single-Button Arming" above).   |
| Arming Instant                         | Enter code + INSTANT [7].   |
| Arming Maximum                         | Enter code + MAXIMUM [4] or simply press appropriate lettered key on the keypads (see "Single-Button Arming" above).  |
| Disarming                              | Enter code + OFF [1]. If entry delay or an alarm is active, you do not need to press OFF.   |
| Bypassing Zones                        | Enter code + BYPASS [6] + zone number(s).   |
| Forced (Quick) Bypass                  | To automatically bypass all faulted zones, use the "Quick Bypass" method. Enter code + BYPASS + [#], then wait for all open zones to be displayed. Arm when display indicates "ZONE BYPASSED" and "READY TO ARM".   |
| Chime Mode                             | Enter code + CHIME [9]. To turn chime off, enter code + CHIME again.  |
| Activate Output Devices                | If relay outputs (via a 4204, or 4229) are used, two keypad entries available to the user are included. If programmed, these entries can be used to manually activate or deactivate the device(s) for starting or stopping some action, such as turning lights on or off, etc. These keypad entries are:<br>[Security Code] + # + 7 + [2-digit Device #] activates (starts) that device.<br>[Security Code] + # + 8 + [2-digit Device #] deactivates (stops) that device. |

## SUMMARY OF ARMING MODES

| Arming Mode | Features for Each Arming Mode |             |                 |   |
|-------------|-------------------------------|-------------|-----------------|---|
|             | Exit Delay                    | Entry Delay | Perimeter Armed | Interior Armed                                  |
| AWAY        | Yes                           | Yes         | Yes             | Yes   |
| STAY        | Yes                           | Yes         | Yes             | No  |
| NIGHT-STAY  | Yes                           | Yes         | Yes             | only those zones listed in Night-Stay zone list |
| INSTANT     | Yes                           | No          | Yes             | No  |
| MAXIMUM     | Yes                           | No          | Yes             | Yes   |

## Panic Keys

There are three Panic keys (A, B, and C) that, if programmed, can be used to manually initiate alarms and send a report to the central station.

Each key can be programmed for 24-hour Silent, 24-hour Audible, Fire, or Personal Emergency responses. The programmed Panic response is activated when the appropriate key is pressed for at least 2 seconds.

The Panic keys are identified by the system as follows:

| Keys      | Displayed as Zone |
|-----------|-------------------|
| [A] (*/1) | 95                |
| [B] (*/#) | 99                |
| [C] (3/#) | 96                |

**IMPORTANT:** For a Silent panic function (if programmed) to be of practical value, you must program a report code for the zone and the system must be connected to a central station.

## Setting the Real-Time Clock

**IMPORTANT:** The Real-Time Clock must be set before the end of the installation.

**NOTE:** All partitions must be disarmed before time/date can be set.

Set the time and date by doing the following:

1.     +[#] + [6] [3]  
(Master Code)

Alpha Display:

```
DISARMED
READY TO ARM
```

2. Press [\*] when the time/date is displayed.  
A cursor appears under the first digit of the hour.  
*To move cursor ahead, press [\*]. To go back, press [#].*

- Enter the 2-digit hour setting.
- Enter the 2-digit minute setting.
- Press [1] for PM or [2] for AM.
- Enter the last two digits of the current year.
- Enter the 2-digit month setting.
- Enter the 2-digit day setting.

```
TIME/DATE SAT
04:04PM 10/17/00
```

Current time display

```
TIME/DATE SAT
04:04P2000/10/17
```

Time/date editing display

3. To exit, press [\*] when cursor is at the last digit, or wait 30 seconds.

## Various System Trouble Displays

| Alpha Display                       | Fixed Disp.             | Meaning   |
|-------------------------------------|-------------------------|---|
| ALARM CANCELED                      | CA                      | Will appear if an exit or interior zone contained a fault during closing at the time the Exit Delay ended (e.g., exit door left open), but the system was disarmed during the Entry Delay time. The alarm sounder and keypad sound continuously, but stop when the system is disarmed. No message will be transmitted to the central station.   |
| EXIT ALARM                          | EA                      | Appears when Exit Delay ends if an exit or interior zone contained a fault during closing. The alarm sounder and keypad sound continuously until the system is disarmed (or timeout occurs). An "Exit Alarm" message is sent to the central station. Also results if an alarm from an exit or interior zone occurs within 2 minutes after the end of an Exit Delay.   |
| CHECK                               | CHECK                   | Indicates that a problem exists with the displayed zone(s) and requires attention.  |
| ALARM 1xx<br>FAULT 1xx<br>CHECK 1xx | 1xx<br>1xx<br>1xx<br>91 | Indicates that communication between control and a zone expander or wireless receiver is interrupted, where "xx" is the device address. Check the wiring and DIP switch settings on the units.<br>If field *199 is set to "1," all ECP module problems are displayed as "91."<br>If there are wireless sensors in the system, the Check condition may also be caused by some change in the environment that prevents the receiver from receiving signals from a particular sensor.          |
| SYSTEM LO BAT                       | BAT                     | With no zone number indicates that the system's standby battery is weak.  |
| LO BAT                              | BAT                     | With a zone number and a once-per-minute beeping at the keypad indicates that a low-battery condition exists in the wireless sensor displayed (zone "00" indicates a wireless keypad). If the battery is not replaced within 30 days, a "CHECK" display may occur.<br>NOTE: Some wireless sensors contain a non-replaceable long-life battery which requires replacement of the entire unit at the end of battery life (e.g., Nos. 5802, 5802CP).   |
| TELCO FAULT                         | 94                      | Telephone Line Failure, indicates that a monitored telephone line (if programmed in field *92) has been cut or disconnected. Depending on how the system was programmed, the keypad may also produce a trouble sound, and the external sounder may be activated. Silence by entering installer code + OFF.  |
| Busy-Standby                        | dl                      | If this remains displayed for more than 1 minute, the system is disabled.<br><b>NOTE for CANADIAN PANELS:</b> Power up time is 2 minutes, and CID code 305 System Reset is sent if the [#] + [0] command is not performed before the 2 minutes expires.   |
| Modem Comm                          | CC                      | The system is in communication with the central station for change of function or status verification.  |
| no display                          | no display              | Power Failure<br>If there is no keypad display at all and the LEDs are unlit, operating power (AC and battery) for the system has stopped and the system is inoperative. If the message "AC LOSS" (Alpha display keypads) or "NO AC" (Fixed-Word display keypads) is displayed, the keypad is operating on battery power only. If the battery standby capacity is used up during a prolonged AC power outage, the control's power will shut down to minimize deep discharge of the battery. |
| Comm. Failure                       | FC                      | A communication failure has occurred.   |
| Open Circuit                        | 0C                      | The keypad is not receiving signals from the control; sees an open circuit.   |
| Long Rng Trbl                       | bF                      | Backup communication device (LRR) had communication failure.  |
| Bell Failure                        | 70                      | Bell supervision failure.   |
| RCVR Jam                            | 90                      | RF jam detected.  |
| KEYPAD LOW BAT                      | 00 BAT                  | Wireless keypad low battery.  |
| Phone Okay                          | Cd                      | The dialer test has been successful (CID code 601).   |
| Dialer Off                          | d0                      | The dialer is disabled.   |
| Test in Progress                    | dd                      | Walk test mode is active (CID code 607).  |
| Upload Completed                    | dC                      | The upload or download session was completed.   |
| Upload Failed                       | dF                      | The upload or download session failed before completion.  |

# SECTION 4

## *Testing the System*

### About Test Procedures

After the installation is complete, you should perform the following tests:

- System Test:** Checks that all zones have been installed properly and the system responds to faults.
- Dialer Test:** Checks that the phone connection to the central station is working properly.
- Go/No Go Test:** Checks that transmissions can be received from transmitters. Should be performed before permanently mounting transmitters.
- RF Sniffer Mode:** Checks that RF transmitter serial numbers have been properly enrolled.
- Battery Tests:** Automatic battery tests are performed by the system.

### System Test

**NOTE:** Test mode can be entered from any keypad. However, faulted zones appear only on those keypads assigned to the partition to which the zone is assigned (i.e., partition 1 zones appear only on partition 1 keypads, etc.). To see another partition's faulted zones, view a keypad assigned to that partition or use the GOTO command (code +[\*] + partition number 0-3, where 0 is the keypad's home partition).

With the system in the disarmed state, check that all zones in the partition to be tested are intact (not faulted). Doors and windows with contacts should be closed, PIRs should be covered (use a cloth to mask them temporarily if necessary). If a "NOT READY" message is displayed, press [\*] to display the faulted zone(s). Restore faulted zone(s) if necessary, so that the "READY" message is displayed.

1. Enter Installer Code + 5 [TEST] , then press "0" at the prompt to start Walk Test mode.

1=DIAL, 0=WALK

(no special display on Fixed-Word keypads)

The following will be displayed on the initiating keypad and a Contact ID report will be sent (code 607):

TEST IN PROGRESS

("dd" displayed on Fixed-Word Display Keypads)

2. Upon entering the system test mode, the outside sounder should sound for 1 second. If the backup battery is discharged or missing, the sounder may not turn on and a "LOW BATTERY" report will be transmitted with a "TEST" report. The keypad will beep about every 30 seconds as a reminder that the system is in the Test mode.  
**NOTE:** Wireless motion detectors (Passive Infrared units) will send signals out only if they have been inactive for 3 minutes (conserves battery life).
3. Test all sensors using the procedure described in the User's Guide "Testing the System" section.
4. After checking sensors, turn off the test mode by entering installer code + OFF.

**NOTE:** Test mode automatically ends after 4 hours. During the final 5 minutes (after 3 hours 55 minutes of Test mode), the keypad emits a double-beep every 30 seconds to alert that the end of Test mode is nearing.

### Checking Transmitter Enrollment (Sniffer Mode)

Use this mode to verify that all transmitters have been properly programmed. Make sure both partitions are disarmed before trying to enter this mode, since this is a system-wide command.

1. From a keypad in partition 1, press [Installer code] + [#] + 3.  
**NOTE:** If the communicator is in the process of sending a report to the central station, the system will not go into the Sniffer mode. If so, wait a few minutes, and try again.  
The keypads in both partitions will display all zone numbers of wireless units (in both partitions) programmed into the system. Fault each transmitter in turn, causing each one to send a signal. As the system receives a signal from each of the transmitters, the zone number of that transmitter disappears from the display.
2. After all transmitters have been checked, exit the sniffer mode by keying [Installer code] + OFF.  
**IMPORTANT:** Sniffer mode does not automatically expire. You must manually exit Sniffer mode (by entering [Installer code] + OFF) to return to normal operation.

- NOTES:**
- All BR type units must physically be activated to clear the display.
  - When **one** button of a transmitter (RF, UR, or BR) is activated, all zones assigned to other buttons on that transmitter are cleared from the display. This also applies to 5816 and 5817 transmitters, which have multiple loops (zones).
  - Any transmitter that is not “enrolled” will not turn off its zone number.

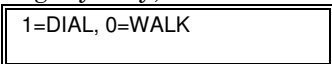
## Go/No Go Test Mode

The Go/No Go Test verifies adequate RF signal strength from the proposed transmitter location, and allow you to reorient or relocate transmitters if necessary, before mounting the transmitters permanently. This mode is similar to the Transmitter Test mode, except that the wireless receiver gain is reduced. This will enable you to make sure that the RF signal from each transmitter is received with sufficient signal amplitude when the system is in the normal operating mode.

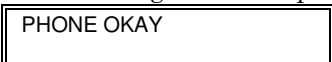
1. Enter [Installer code] + [#] + 4 from the partition being tested. For multi-partition systems, repeat this test for each partition.
2. After you have placed transmitters in their desired locations and the approximate length of wire to be run to sensors is connected to the transmitter's screw terminals (if used), fault each transmitter. Do not conduct this test with your hand wrapped around the transmitter, as this will cause inaccurate results.
  - a. The keypad will beep three times to indicate signal reception and display the zone number.
  - b. If the keypad does not beep, you should reorient or move the transmitter to another location. Usually a few inches in either direction is all that is required.
4. If each transmitter produces the proper keypad response when it is faulted, you can then permanently mount each of the transmitters according to the instructions provided with them.
5. Exit the Go/No Go Test mode by entering: [any user code (partition-specific)] + OFF.

## Dialer Communication Test and Periodic Test Reports

1. Enter Installer Code + 5 [TEST], then press “1” at the prompt to start the Dialer Test (checks phone line integrity only; does not confirm report transmissions).

 (no special display on Fixed-Word keypads)

The following will be displayed (accompanied by 2 beeps) if test is successful:

 (“Cd” displayed on Fixed-Word Display Keypads)

A Contact ID report will also be sent (code 601)

If the dialer test is unsuccessful, “COMM FAILURE” (or FC) is displayed.

2. Enter Installer code + OFF to clear the display and exit.

### Automatic Periodic Test Report

The system can be set to automatically send test reports (enabled in field \*64; Contact ID code 602) at specified intervals. Frequency of the reports is set in Scheduling mode (event 11) or by the following key commands:

**installer code + [#] + 0 + 0** = test report sent every 24 hours

**installer code + [#] + 0 + 1** = test report sent once per week

**installer code + [#] + 0 + 2** = test report sent every 28 days

Each mode sets schedule 32 (VISTA-20P) or schedule 08 (VISTA-15P) to the selected repeat option; the first test report is sent 12 hours after command.

To ensure that test reports are sent at the times expected, set the Real-Time Clock to the proper time **before** entering the test report schedule command.

### Automatic Standby Battery Tests

1. An automatic test is conducted every 3 minutes to ensure that a standby battery is present and properly connected. If a battery is not present or is not properly connected, a “LOW BATTERY” message is displayed and, if so programmed, will be reported to the central station.
2. A battery capacity test is automatically conducted for 2 minutes every 4 hours, beginning 4 hours after exiting the Programming mode or after powering up the system. In addition, entry into the Test mode will also cause a battery capacity test to be initiated. If the battery cannot sustain a load, a “Low Battery” message is displayed and, if so programmed, will be reported to the central station.

# Specifications & Accessories

## Security Control

1. **Physical:** 12-1/2" W x 14-1/2" H x 3" D (318mm x 368mm x 76mm)
2. **Electrical:**  
 VOLTAGE INPUT: 16.5VAC from plug-in 25VA transformer, ADEMCO 1321 (in U.S.A.)  
 RECHARGEABLE BACKUP BATTERY: 12VDC, (sealed lead acid type); see Battery Table in Mounting & Wiring section for proper battery sizes for various maximum current drains.  
 Charging Voltage: 13.8VDC.  
 ALARM SOUNDER: 12V, 2.0 Amp output can drive 12V BELLS or can drive one or two 702 (series connected) self-contained 20-watt sirens. Do **not** connect two 702s in parallel.  
 AUXILIARY POWER OUTPUT: 12VDC, 600mA max.  
**NOTE:** For UL installations, Alarm Sounder plus Auxiliary Power currents should not exceed 600mA total (500mA Aux, 100mA Bell Output).  
 FUSE (if installed): Battery (3A) No. 90-12 (PC board may have a PTC device instead of a fuse. The PTC serves as an automatically resetting fuse.)  
**NOTE:** This equipment shall be installed in accordance with the National Electrical Code, ANSI/NFPA 70 and the National Fire Alarm Code, ANSI/NFPA 72.
3. **Communication:**  
 FORMAT SUPPORTED:  
 ADEMCO Express: 10 characters/sec, DTMF (TouchTone) Data Tones, 1400/2300Hz ACK, 1400Hz KISSOFF.  
 ADEMCO Low Speed: 10 pulses/sec, 1900Hz Data Tone, 1400Hz ACK/KISSOFF.  
 Radionics/SESCOA: 20 pulses/sec, 1800Hz Data Tone, 2300Hz ACK/KISSOFF.  
 Can report 0-9, B-F  
 Ademco Contact ID 10 characters/sec., DTMF (TouchTone) Data Tones, 1400/2300Hz ACK, 1400Hz KISSOFF.  
 LINE SEIZE: Double Pole  
 RINGER EQUIVALENCE: 0.1B  
 FCC REGISTRATION No.: 5GBUSA-44003-AL-E
4. **Maximum Zone Resistance:** Zones 2-8 = 300 ohms excluding EOLR standard zones  
 Zone 1 = 100 ohms excluding EOLR

**SIA Minimum Hardware Configuration:** 1 model VISTA-20PSIA/15PSIA control panel, and 1 6160V keypad, and 1 UL Listed Bell.

## Compatible Devices

- Keypads:** 6150 Fixed-Word Keypad, 6160 Alpha Keypad, 6150V and 6160V Voice Keypads, 6280 Touch Screen Keypad, Tuxedo Touch Advanced User Interface (AUI)
- Wireless Receivers:** 5881ENL/5882L: accepts up to 8 transmitters  
 5881ENM/5882M: accepts up to 16 transmitters  
 5881ENH/5882H: accepts up to system maximum transmitters  
 5883H Transceiver: accepts up to system maximum transmitters  
 6150RF Keypad/Transceiver: accepts up to 16 transmitters  
 6160RF Keypad/Transceiver: accepts up to system maximum trans.
- Zone Expansion:** 4219 WIRED EXPANSION MODULE  
 4229 WIRED EXPANSION/RELAY MODULE
- Relay Module:** 4204 RELAY MODULE
- Communication Device:** GSMV4G, GSMX4G, IGSMV4G, 7847i

**2-Wire Smoke Detector:**

| <b>Detector Type</b>        | <b>System Sensor Model No.</b> |
|-----------------------------|--------------------------------|
| Photoelectric w/heat sensor | 2WT-B                          |
| Photoelectric               | 2W-B                           |
| Photoelectric               | 2151 w/B110LP base             |

**Transformers:** 1321: 16.5VAC, 25VA Plug-In Transformer (No. 1321CN in Canada)

**Sounders:** AB12M 10" Motorized Bell & Box  
702 Outdoor Siren  
719 2-Channel Siren  
713 High Power Speaker  
745VSD3 Voice Siren Driver  
746 Indoor Speaker  
747 Indoor Siren  
747PD Two-Tone Piezo Dynamic Indoor Siren  
747UL Indoor Siren  
748 Dual Tone Siren  
749 Speaker/Horn  
713 Speaker  
WAVE Speaker  
WAVE2 Two-Tone Siren  
WAVE2PD Two-Tone Piezo Dynamic Siren  
5800WAVE Wireless Siren  
System Sensor MHW (white)/; MHR (red) Indoor Piezo Sounder

## CONTACTING TECHNICAL SUPPORT

**PLEASE, before you call Technical Support, be sure you:**

- READ THE INSTRUCTIONS!
- Check all wiring connections.
- Determine that the power supply and/or backup battery are supplying proper voltages.
- Verify your programming information where applicable.
- Note the proper model number of this product, and the version level (if known) along with any documentation that came with the product.
- Note your Honeywell customer number and/or company name.

Having this information handy will make it easier for us to serve you quickly and effectively.

|                          |   |
|--------------------------|---|
| Technical Support: ..... | 1-800-645-7492 (8 a.m.-10 p.m. ET.)   |
| MyWebTech: .....         | <a href="https://MyWebTech.honeywell.com">https://MyWebTech.honeywell.com</a> |



# Regulatory Agency Statements

## FEDERAL COMMUNICATIONS COMMISSION (FCC) PART 15

The user shall not make any changes or modifications to the equipment unless authorized by the Installation Instructions or User's Manual. Unauthorized changes or modifications could void the user's authority to operate the equipment.

### CLASS B DIGITAL DEVICE STATEMENT

This equipment has been tested to FCC requirements and has been found acceptable for use. The FCC requires the following statement for your information:

This equipment generates and uses radio frequency energy and if not installed and used properly, that is, in strict accordance with the manufacturer's instructions, may cause interference to radio and television reception. It has been type tested and found to comply with the limits for a Class B computing device in accordance with the specifications in Part 15 of FCC Rules, which are designed to provide reasonable protection against such interference in a residential installation. However, there is no guarantee that interference will not occur in a particular installation. If this equipment does cause interference to radio or television reception, which can be determined by turning the equipment off and on, the user is encouraged to try to correct the interference by one or more of the following measures:

- If using an indoor antenna, have a quality outdoor antenna installed.
- Reorient the receiving antenna until interference is reduced or eliminated.
- Move the radio or television receiver away from the receiver/control.
- Move the antenna leads away from any wire runs to the receiver/control.
- Plug the receiver/control into a different outlet so that it and the radio or television receiver are on different branch circuits.
- Consult the dealer or an experienced radio/TV technician for help.

This Class B digital apparatus complies with Canadian ICES-003.

Cet appareil numérique de la classe B est conforme à la norme NMB-003 du Canada.

### FCC/IC STATEMENT

This device complies with Part 15 of the FCC rules and RSS-210 of Industry Canada. Operation is subject to the following two conditions: (1) This device may not cause harmful interference, and (2) This device must accept any interference received, including interference that may cause undesired operation.

Cet appareil est conforme à la partie 15 des règles de la FCC & de RSS-210 des Industries Canada. Son fonctionnement est soumis aux conditions suivantes: (1) Cet appareil ne doit pas causer d'interférences nuisibles. (2) Cet appareil doit accepter toute interférence reçue y compris les interférences causant une réception indésirable.

## TELEPHONE/MODEM INTERFACE

### FCC Part 68

This equipment complies with Part 68 of the FCC rules. On the front cover of this equipment is a label that contains the FCC registration number and Ringer Equivalence Number (REN). You must provide this information to the telephone company when requested.

This equipment uses the following USOC jack: RJ31X

This equipment may not be used on telephone-company-provided coin service. Connection to party lines is subject to state tariffs. This equipment is hearing-aid compatible.

### Industry Canada

**NOTICE:** The Industry Canada Label identifies certified equipment. This certification means that the equipment meets telecommunications network protective, operational and safety requirements as prescribed in the appropriate Terminal Equipment Technical Requirements document(s). The Department does not guarantee the equipment will operate to the user's satisfaction.

Before installing this equipment, users should ensure that it is permissible to be connected to the facilities of the local telecommunications company. The equipment must also be installed using an acceptable method of connection. The customer should be aware that compliance with the above conditions may not prevent degradation of service in some situations.

Repairs to certified equipment should be coordinated by a representative designated by the supplier. Any repairs or alterations made by the user to this equipment, or equipment malfunctions, may give the telecommunications company to request the user to disconnect the equipment.

Users should ensure for their own protection that the electrical ground connections of the power utility, telephone lines and internal metallic water pipe system, if present, are connected together. This precaution may be particularly important in rural areas.

**Caution:** Users should not attempt to make such connections themselves but should contact appropriate electric inspection authority, or electrician, as appropriate.

### Ringer Equivalence Number Notice:

The **Ringer Equivalence Number (REN)** assigned to each terminal device provides an indication of the maximum number of terminals allowed to be connected to a telephone interface. The termination on an interface may consist of any combination of devices subject only to the requirement that the sum of the Ringer Equivalence Numbers of all the devices does not exceed 5.

### Industrie Canada

**AVIS:** l'étiquette d'Industrie Canada identifie le matériel homologué. Cette étiquette certifie que le matériel est conforme aux normes de protection, d'exploitation et de sécurité des réseaux de télécommunications, comme le prescrivent les documents concernant les exigences techniques relatives au matériel terminal. Le Ministère n'assure toutefois pas que le matériel fonctionnera à la satisfaction de l'utilisateur.

Avant d'installer ce matériel, l'utilisateur doit s'assurer qu'il est permis de le raccorder aux installations de l'entreprise locale de télécommunication. Le matériel doit également être installé en suivant une méthode acceptée de raccordement. L'abonné ne doit pas oublier qu'il est possible que la conformité aux conditions énoncées ci-dessus n'empêche pas la dégradation du service dans certaines situations.

Les réparations de matériel homologué doivent être coordonnées par un représentant désigné par le fournisseur. L'entreprise de télécommunications peut demander à l'utilisateur de débrancher un appareil à la suite de réparations ou de modifications effectuées par l'utilisateur ou à cause de mauvais fonctionnement.

Pour sa propre protection, l'utilisateur doit s'assurer que tous les fils de mise à la terre de la source d'énergie électrique, de lignes téléphoniques et des canalisations d'eau métalliques, s'il y en a, sont raccordés ensemble. Cette précaution est particulièrement importante dans les régions rurales.

**Avertissement :** L'utilisateur ne doit pas tenter de faire ces raccordements lui-même; il doit avoir recours à un service d'inspection des installations électriques, ou à un électricien, selon le cas.

**AVIS :** L'indice d'équivalence de la sonnerie (IES) assigné à chaque dispositif terminal indique le nombre maximal de terminaux qui peuvent être raccordés à une interface. La terminaison d'une interface téléphonique peut consister en une combinaison de quelques dispositifs, à la seule condition que la somme d'indices d'équivalence de la sonnerie de tous les dispositifs n'excède pas 5.

### UL NOTICES

1. Entry Delay No. 1 and No. 2 (fields \*35, \*36) cannot be greater than 30 seconds for UL Residential Burglar Alarm installations, and entry delay plus dial delay should not exceed 1 minute. For UL Commercial Burglar Alarm installations, total entry delay may not exceed 45 seconds.
2. For UL Commercial Burglar Alarm and UL Residential Burglar Alarm installations with line security, total exit delay time must not exceed 60 seconds.
3. The maximum number of reports per armed period (field \*93) must be set to "0" (unlimited) for UL installations.
4. Periodic testing (see scheduling mode) must be at least every 24 hours.
5. Alarm Sounder plus Auxiliary Power currents must not exceed 600mA total for UL installations (Aux power 500mA max.).
6. All partitions must be owned and managed by the same person(s).
7. All partitions must be part of one building at one street address.
8. If used, the audible alarm device(s) must be placed where it/they can be heard by all partitions.
9. For UL commercial burglar alarm installations the control unit must be protected from unauthorized access. The tamper switch installed to protect the control unit enclosure door is suitable for this purpose.
10. Remote downloading without an alarm company technician on-site (unattended downloading) is not permissible for UL installations.
11. Auto-disarming is not a UL Listed feature.
12. As SIA limits for delay of alarm reporting and sounding can exceed UL limits for commercial and residential applications, the following UL requirements per UL681 are provided:  
The maximum time that a control unit shall be programmed to delay the transmission of a signal to a remote monitoring location, or to delay the energizing of a local alarm sounding device to permit the alarm system user to enter and disarm the system, or to arm the system and exit shall not exceed:
  - a) 60 seconds for a system with standard line security or encrypted line security,
  - b) 120 seconds for a system without standard line security or encrypted line security, or
  - c) 120 seconds for a system that does not transmit an alarm signal to a remote monitoring location.
13. This control is not intended for bank safe and vault applications.

### SIA Quick Reference Guide

1. \*31 Single Alarm Sounding per Zone: If "0" selected, "alarm sounding per zone" will be the same as the "number of reports in armed period" set in field \*93 (1 if one report, 2 if 2 reports, unlimited for zones in zone list 7).
2. \*34 Exit Delay: Minimum exit delay is 45 seconds.
3. \*35/\*36 Entry Delay 1 and 2: Minimum entry delay is 30 seconds.
4. \*37 Audible Exit Warning: Feature always enabled; field does not exist.
5. \*39 Power Up in Previous State: Must be "1," power up in previous state.
6. \*40 PABX Access Code or Call Waiting Disable: If call waiting is used, call waiting disable option in field \*91 must be set.
7. \*50 Burglary Dial Delay: Delay must be a minimum of 30 seconds.
8. \*59 Exit Error Alarm Report Code: Always enabled.
9. \*68 Cancel Report Code: Default is "code enabled."
10. \*69 Recent Closing Report Code: Always enabled.
11. \*91 Option Selection: Exit Delay option should be enabled. If call waiting is used, Call Waiting Disable must be set to "1" (enabled).
12. \*93 No. reports in Armed Period: Must be set for 1 or 2 report pairs.
13. Cross zone timer programming is set in field \*85; cross zone pairs are assigned in zone list 4 using \*81 Zone List mode.
14. Duress code is assigned by using the "add a user code" procedure found in the User Guide. Enable Duress code reporting by programming zone 92 using \*56 Zone Programming mode.
15. Fire alarm verification is a built-in system feature when a zone is programmed for zone type 16.

---

– NOTES –

**– NOTES –**

# Limitations and Warranty

## WARNING

### THE LIMITATIONS OF THIS ALARM SYSTEM

While this System is an advanced design security system, it does not offer guaranteed protection against burglary, fire or other emergency. Any alarm system, whether commercial or residential, is subject to compromise or failure to warn for a variety of reasons. For example:

- Intruders may gain access through unprotected openings or have the technical sophistication to bypass an alarm sensor or disconnect an alarm warning device.
- Intrusion detectors (e.g., passive infrared detectors), smoke detectors, and many other sensing devices will not work without power. Battery-operated devices will not work without batteries, with dead batteries, or if the batteries are not put in properly. Devices powered solely by AC will not work if their AC power supply is cut off for any reason, however briefly.
- Signals sent by wireless transmitters may be blocked or reflected by metal before they reach the alarm receiver. Even if the signal path has been recently checked during a weekly test, blockage can occur if a metal object is moved into the path.
- A user may not be able to reach a panic or emergency button quickly enough.
- While smoke detectors have played a key role in reducing residential fire deaths in the United States, they may not activate or provide early warning for a variety of reasons in as many as 35% of all fires, according to data published by the Federal Emergency Management Agency. Some of the reasons smoke detectors used in conjunction with this System may not work are as follows. Smoke detectors may have been improperly installed and positioned. Smoke detectors may not sense fires that start where smoke cannot reach the detectors, such as in chimneys, in walls, or roofs, or on the other side of closed doors. Smoke detectors also may not sense a fire on another level of a residence or building. A second floor detector, for example, may not sense a first floor or basement fire. Finally, smoke detectors have sensing limitations. No smoke detector can sense every kind of fire every time. In general, detectors may not always warn about fires caused by carelessness and safety hazards like smoking in bed, violent explosions, escaping gas, improper storage of flammable materials, overloaded electrical circuits, children playing with matches, or arson. Depending on the nature of the fire and/or location of the smoke detectors, the detector, even if it operates as anticipated, may not provide sufficient warning to allow all occupants to escape in time to prevent injury or death.
- Passive Infrared Motion Detectors can only detect intrusion within the designed ranges as diagrammed in their installation manual. Passive Infrared Detectors do not provide volumetric area protection. They do create multiple beams of protection, and intrusion can only be detected in unobstructed areas covered by those beams. They cannot detect motion or intrusion that takes place behind walls, ceilings, floors, closed doors, glass partitions, glass doors, or windows. Mechanical tampering, masking, painting or spraying of any material on the mirrors, windows or any part of the optical system can reduce their detection ability. Passive Infrared Detectors sense changes in temperature; however, as the ambient temperature of the protected area approaches the temperature range of 90° to 105°F (32° to 40°C), the detection performance can decrease.
- Alarm warning devices such as sirens, bells or horns may not alert people or wake up sleepers if they are located on the other side of closed or partly open doors. If warning devices are located on a different level of the residence from the bedrooms, then they are less likely to waken or alert people inside the bedrooms. Even persons who are awake may not hear the warning if the alarm is muffled by noise from a stereo, radio, air conditioner or other appliance, or by passing traffic. Finally, alarm warning devices, however loud, may not warn hearing-impaired people.
- Telephone lines needed to transmit alarm signals from a premises to a central monitoring station may be out of service or temporarily out of service. Telephone lines are also subject to compromise by sophisticated intruders.
- Even if the system responds to the emergency as intended, however, occupants may have insufficient time to protect themselves from the emergency situation. In the case of a monitored alarm system, authorities may not respond appropriately.
- This equipment, like other electrical devices, is subject to component failure. Even though this equipment is designed to last as long as 10 years, the electronic components could fail at any time.

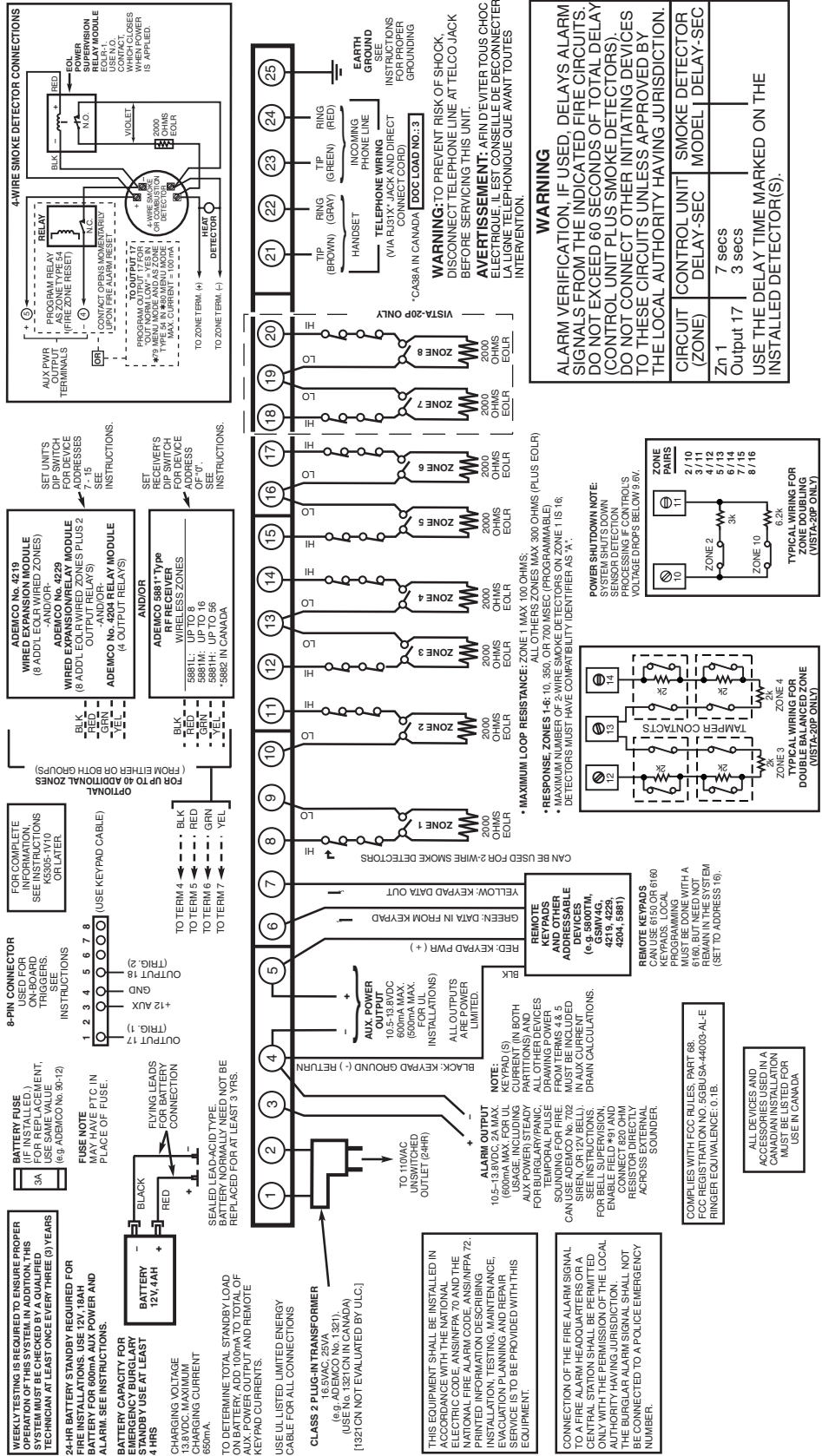
The most common cause of an alarm system not functioning when an intrusion or fire occurs is inadequate maintenance. This alarm system should be tested weekly to make sure all sensors and transmitters are working properly. The security keypad (and remote keypad) should be tested as well.

Wireless transmitters (used in some systems) are designed to provide long battery life under normal operating conditions. Longevity of batteries may be as much as 4 to 7 years, depending on the environment, usage, and the specific wireless device being used. External factors such as humidity, high or low temperatures, as well as large swings in temperature, may all reduce the actual battery life in a given installation. This wireless system, however, can identify a true low-battery situation, thus allowing time to arrange a change of battery to maintain protection for that given point within the system. Installing an alarm system may make the owner eligible for a lower insurance rate, but an alarm system is not a substitute for insurance. Homeowners, property owners and renters should continue to act prudently in protecting themselves and continue to insure their lives and property.

We continue to develop new and improved protection devices. Users of alarm systems owe it to themselves and their loved ones to learn about these developments.

# – INDEX –

|  |                                    |                                |                |                                 |                          |
|--|------------------------------------|--------------------------------|----------------|---------------------------------|--------------------------|
| 1321 .....                                       | 1-2, 2-3, 2-11                     | Device address.....            | 2-5, 2-11, 3-8 | Relay Modules.....              | 2-11                     |
| 3+1 and 4+1 Standard Formats .....               | 3-1                                | Dialer Communication Test..... | 4-2            | Report Code .....               | 3-1                      |
| 4204 .....                                       | 1-2, 2-2, 2-5, 2-6, 2-11, 3-6, 5-1 | DIP Switches.....              | 2-9            | Report Code Formats .....       | 3-1                      |
| 4219 .....                                       | 1-1, 1-2, 2-2, 2-5, 2-7, 5-1       | Disarming .....                | 3-6            | Response time .....             | 2-7                      |
| 42291-1, 1-2, 2-2, 2-5, 2-6, 2-7, 2-11, 3-6, 5-1 |                                    | Double-Balanced .....          | 2-6            | RF House ID Code .....          | 2-8                      |
| 5801 .....                                       | 2-9                                | Entry Delay .....              | 3-7, 3-8       | RF Interference .....           | 2-8                      |
| 5802 .....                                       | 2-9, 3-8                           | EOLR .....                     | 2-6, 5-1       | RF jam detection .....          | 1-1                      |
| 5802CP.....                                      | 2-9, 3-8                           | Exit Delay .....               | 3-7, 3-8       | RF Jam Option .....             | 2-8                      |
| 5827 .....                                       | 2-9                                | Exit Error Alarm .....         | 3              | RF Receiver .....               | 2-1, 2-2, 2-5, 2-8, 3    |
| 5827BD.....                                      | 2-9                                | Exit Error Alarm .....         | 3-8            | RJ31X Jack .....                | 2-13                     |
| 5881 .....                                       | 2-2, 2-8                           | Expansion Zones.....           | 2-7            | SA4120XM-1 Cable.....           | 2-3                      |
| 8-pin connector .....                            | 2-10                               | Fast Busy Signal.....          | 2-13           | Security Codes .....            | 1-1, 3-5                 |
| AC Power Supply.....                             | 1-2                                | Fire Verification.....         | 2-7            | Silent Burglary.....            | 3                        |
| AC Transformer .....                             | 2-3, 2-12, 5-2                     | Go/No Go Test Mode.....        | 4-2            | Silent Panic .....              | 3-7                      |
| Ademco Contact ID .....                          | 3-3                                | Handshake .....                | 3-1            | Sniffer Mode .....              | 4-1                      |
| Alarm Output.....                                | 2-2, 2-4                           | Hardwired zones.....           | 1-1            | Sounder connections.....        | 2-4                      |
| Arming Away.....                                 | 3-6                                | HAYES Modem .....              | 1-1            | Supplementary Power .....       | 2-4                      |
| Arming Instant.....                              | 3-6                                | House ID .....                 | 2-9            | System Communication.....       | 3-1                      |
| Arming Modes.....                                | 3-7                                | Ideal Model 61-035 .....       | 2-3            | System Test .....               | 4-1                      |
| Arming Stay .....                                | 3-6                                | Installer Code .....           | 4-1, 4-2       | Tamper switch.....              | 2-10, 6-2                |
| Audio Alarm Verification.....                    | 2-13                               | Keypad addresses .....         | 2-5            | Telco Line.....                 | 2-13, 3                  |
| Audio Alarm Verification (AAV) .....             | 2-13                               | Kissoff .....                  | 3-1            | Telephone Line Monitoring ..... | 1-1                      |
| AUI .....  | 2-5                                | Lock.....                      | 2-1            | Test Mode .....                 | 4-1, 4-2                 |
| Authority Levels .....                           | 3-5                                | Low Battery Message .....      | 4-2            | Transmitters .....              | 2-9                      |
| Auxiliary Output .....                           | 2-2                                | Model 112 Tamper Switch .....  | 2-10           | Trigger outputs.....            | 2-12                     |
| Backup Battery .....                             | 1-2                                | Modem .....                    | 3-8            | Trouble Displays.....           | 3-7, 3-8                 |
| Battery Life.....                                | 2-9                                | On-board triggers .....        | 2-14           | UL .....                        | 2-2, 2-4, 2-11, 5-1, 6-2 |
| Battery Tests.....                               | 4-1, 4-2                           | Output relays .....            | 1-2            | Wire Run Chart.....             | 2-4, 2-5                 |
| Bypassing Zones .....                            | 3-6                                | Panic Keys .....               | 3-7            | Zone Doubling.....              | 2-6                      |
| Cabinet .....                                    | 2-1                                | Periodic Test Reports .....    | 4-2            |                                 |                          |
| California State Fire Marshall .....             | 2-2                                | Phone Line .....               | 2-13           |                                 |                          |
| Caller ID Unit .....                             | 2-13                               | Power Failure .....            | 3-8            |                                 |                          |
| Charging Voltage .....                           | 5-1                                | Power supply .....             | 2-2, 2-4, 7-3  |                                 |                          |
| Chime Mode .....                                 | 3-6                                |                                |                |                                 |                          |
| Clean Me Option.....                             | 2-7                                |                                |                |                                 |                          |
| Communication.....                               | 3-1, 5-1                           |                                |                |                                 |                          |
| Communication Device .....                       | 5-1                                |                                |                |                                 |                          |
| Communication Device (LRR).....                  | 2-5, 3                             |                                |                |                                 |                          |
| Contact ID Reporting .....                       | 5-1                                |                                |                |                                 |                          |
| CSFM .....                                       | 2-2                                |                                |                |                                 |                          |
| Current Draw Worksheet.....                      | 2-2                                |                                |                |                                 |                          |



ADEMCO VISTA-20P / VISTA-20PSIA SERIES / VISTA-15P / VISTA-15PSIA SERIES  
SUMMARY OF CONNECTIONS

VZBP\_V15P-S0CC-V11

Figure 17. Summary of Connections

## **WARRANTY INFORMATION**

For the latest warranty information, please go to:

[www.honeywell.com/security/hsc/resources/wa](http://www.honeywell.com/security/hsc/resources/wa)

# **Honeywell**

2 Corporate Center Drive, Suite 100  
P.O. Box 9040, Melville, NY 11747  
Copyright © 2004 Honeywell International Inc.

[www.honeywell.com/security](http://www.honeywell.com/security)



K5305-1V10 3/15 Rev. A