

RIGOL

Performance Verification Guide

DSG3000 Series RF Signal Generator

Oct. 2015

RIGOL Technologies, Inc.

Guaranty and Declaration

Copyright

© 2014 RIGOL Technologies, Inc. All Rights Reserved.

Trademark Information

RIGOL is a registered trademark of RIGOL Technologies, Inc.

Publication Number

PVG01102-1110

Notices

- **RIGOL** products are covered by P.R.C. and foreign patents, issued and pending.
- **RIGOL** reserves the right to modify or change parts of or all the specifications and pricing policies at company's sole decision.
- Information in this publication replaces all previously corresponding material.
- Information in this publication is subject to change without notice.
- **RIGOL** shall not be liable for either incidental or consequential losses in connection with the furnishing, use or performance of this manual as well as any information contained.
- Any part of this document is forbidden to be copied, photocopied or rearranged without prior written approval of **RIGOL**.

Product Certification

RIGOL guarantees this product conforms to the national and industrial standards in China as well as the ISO9001:2008 standard and the ISO14001:2004 standard. Other international standard conformance certification is in progress.

Contact Us

If you have any problem or requirement when using our products or this manual, please contact **RIGOL**.

E-mail: service@rigol.com

Websites: www.rigol.com

General Safety Summary

Please review the following safety precautions carefully before putting the instrument into operation so as to avoid any personal injury or damage to the instrument and any product connected to it. To prevent potential hazards, please use the instrument only specified by this manual.

Use Proper Power Cord.

Only the power cord designed for the instrument and authorized for use within the local country could be used.

Ground the Instrument.

The instrument is grounded through the Protective Earth lead of the power cord. To avoid electric shock, it is essential to connect the earth terminal of the power cord to the Protective Earth terminal before connecting any inputs or outputs.

Connect the Probe Correctly.

If a probe is used, do not connect the ground lead to high voltage since it has isobaric electric potential as the ground.

Observe All Terminal Ratings.

To avoid fire or shock hazard, observe all ratings and markers on the instrument and check your manual for more information about ratings before connecting the instrument.

Use Proper Overvoltage Protection.

Make sure that no overvoltage (such as that caused by a thunderstorm) can reach the product, or else the operator might be exposed to the danger of electrical shock.

Do Not Operate Without Covers.

Do not operate the instrument with covers or panels removed.

Do Not Insert Anything Into the Holes of Fan.

Do not insert anything into the holes of the fan to avoid damaging the instrument.

Use Proper Fuse.

Please use the specified fuses.

Avoid Circuit or Wire Exposure.

Do not touch exposed junctions and components when the unit is powered.

Do Not Operate With Suspected Failures.

If you suspect damage occurs to the instrument, have it inspected by **RIGOL** authorized personnel before further operations. Any maintenance, adjustment or replacement especially to circuits or accessories must be performed by **RIGOL** authorized personnel.

Keep Well Ventilation.

Inadequate ventilation may cause an increase of instrument temperature which would cause damage to the instrument. So please keep the instrument well ventilated and inspect the intake and fan regularly.

Do Not Operate in Wet Conditions.

In order to avoid short circuiting to the interior of the device or electric shock, please do not operate the instrument in a humid environment.

Do Not Operate in an Explosive Atmosphere.

In order to avoid damage to the device or personal injuries, it is important to operate the device away from an explosive atmosphere.

Keep Product Surfaces Clean and Dry.

To avoid the influence of dust and/or moisture in the air, please keep the surface of the device clean and dry.

Electrostatic Prevention.

Operate the instrument in an electrostatic discharge protective environment to avoid damage induced by static discharges. Always ground both the internal and external conductors of cables to release static before making connections.

Proper Use of Battery.

If a battery is supplied, it must not be exposed to high temperature or in contact with fire. Keep it out of the reach of children. Improper change of battery (note: lithium battery) may cause explosion. Use **RIGOL** specified battery only.

Do Not Overload the Output.

In order to avoid damage to the instrument, the reverse DC voltage on the RF output connector cannot exceed 50 V; the reverse power must be less than +40 dBm (10 W) in the frequency range from 1 MHz to 6 GHz.

Handling Safety.

Please handle with care during transportation to avoid damage to keys, knob interfaces and other parts on the panels.

Safety Terms and Symbols

Terms Used in this Manual. These terms may appear in this manual:

**WARNING**

Warning statements indicate the conditions or practices that could result in injury or loss of life.

**CAUTION**

Caution statements indicate the conditions or practices that could result in damage to this product or other property.

Terms Used on the Product. These terms may appear on the Product:

DANGER It calls attention to an operation, if not correctly performed, could result in injury or hazard immediately.

WARNING It calls attention to an operation, if not correctly performed, could result in potential injury or hazard.

CAUTION It calls attention to an operation, if not correctly performed, could result in damage to the product or other devices connected to the product.

Symbols Used on the Product. These symbols may appear on the product:



**Hazardous
Voltage**



**Safety
Warning**



**Protective
Earth
Terminal**



**Chassis
Ground**



**Test
Ground**

Allgemeine Sicherheits Informationen

Überprüfen Sie die folgenden Sicherheitshinweise sorgfältig um Personenschäden oder Schäden am Gerät und an damit verbundenen weiteren Geräten zu vermeiden. Zur Vermeidung von Gefahren, nutzen Sie bitte das Gerät nur so, wie in diesem Handbuch angegeben.

Um Feuer oder Verletzungen zu vermeiden, verwenden Sie ein ordnungsgemäßes Netzkabel.

Verwenden Sie für dieses Gerät nur das für ihr Land zugelassene und genehmigte Netzkabel.

Erden des Gerätes.

Das Gerät ist durch den Schutzleiter im Netzkabel geerdet. Um Gefahren durch elektrischen Schlag zu vermeiden, ist es unerlässlich, die Erdung durchzuführen. Erst dann dürfen weitere Ein- oder Ausgänge verbunden werden.

Anschluss eines Tastkopfes.

Die Erdungsklemmen der Sonden sind auf dem gleichen Spannungspegel des Instruments geerdet. Schließen Sie die Erdungsklemmen an keine hohe Spannung an.

Beachten Sie alle Anschlüsse.

Zur Vermeidung von Feuer oder Stromschlag, beachten Sie alle Bemerkungen und Markierungen auf dem Instrument. Befolgen Sie die Bedienungsanleitung für weitere Informationen, bevor Sie weitere Anschlüsse an das Instrument legen.

Verwenden Sie einen geeigneten Überspannungsschutz.

Stellen Sie sicher, daß keinerlei Überspannung (wie z.B. durch Gewitter verursacht) das Gerät erreichen kann. Andernfalls besteht für den Anwender die Gefahr eines Stromschlages.

Nicht ohne Abdeckung einschalten.

Betreiben Sie das Gerät nicht mit entfernten Gehäuse-Abdeckungen.

Betreiben Sie das Gerät nicht geöffnet.

Der Betrieb mit offenen oder entfernten Gehäuseteilen ist nicht zulässig. Nichts in entsprechende Öffnungen stecken (Lüfter z.B.)

Passende Sicherung verwenden.

Setzen Sie nur die spezifikationsgemäßen Sicherungen ein.

Vermeiden Sie ungeschützte Verbindungen.

Berühren Sie keine unisolierten Verbindungen oder Baugruppen, während das Gerät in Betrieb ist.

Betreiben Sie das Gerät nicht im Fehlerfall.

Wenn Sie am Gerät einen Defekt vermuten, sorgen Sie dafür, bevor Sie das Gerät wieder betreiben,

dass eine Untersuchung durch **RIGOL** autorisiertem Personal durchgeführt wird. Jedwede Wartung, Einstellarbeiten oder Austausch von Teilen am Gerät, sowie am Zubehör dürfen nur von **RIGOL** autorisiertem Personal durchgeführt werden.

Belüftung sicherstellen.

Unzureichende Belüftung kann zu Temperaturanstiegen und somit zu thermischen Schäden am Gerät führen. Stellen Sie deswegen die Belüftung sicher und kontrollieren regelmäßig Lüfter und Belüftungsöffnungen.

Nicht in feuchter Umgebung betreiben.

Zur Vermeidung von Kurzschluß im Geräteinneren und Stromschlag betreiben Sie das Gerät bitte niemals in feuchter Umgebung.

Nicht in explosiver Atmosphäre betreiben.

Zur Vermeidung von Personen- und Sachschäden ist es unumgänglich, das Gerät ausschließlich fernab jedweder explosiven Atmosphäre zu betreiben.

Geräteoberflächen sauber und trocken halten.

Um den Einfluß von Staub und Feuchtigkeit aus der Luft auszuschließen, halten Sie bitte die Geräteoberflächen sauber und trocken.

Schutz gegen elektrostatische Entladung (ESD).

Sorgen Sie für eine elektrostatisch geschützte Umgebung, um somit Schäden und Funktionsstörungen durch ESD zu vermeiden. Erden Sie vor dem Anschluß immer Innen- und Außenleiter der Verbindungsleitung, um statische Aufladung zu entladen.

Die richtige Verwendung des Akkus.

Wenn eine Batterie verwendet wird, vermeiden Sie hohe Temperaturen bzw. Feuer ausgesetzt werden. Bewahren Sie es außerhalb der Reichweite von Kindern auf. Unsachgemäße Änderung der Batterie (Anmerkung: Lithium-Batterie) kann zu einer Explosion führen. Verwenden Sie nur von **RIGOL** angegebenen Akkus.

Sicherer Transport.

Transportieren Sie das Gerät sorgfältig (Verpackung!), um Schäden an Bedienelementen, Anschlüssen und anderen Teilen zu vermeiden.

Sicherheits Begriffe und Symbole

Begriffe in diesem Guide. Diese Begriffe können in diesem Handbuch auftauchen:



WARNING

Die Kennzeichnung WARNING beschreibt Gefahrenquellen die leibliche Schäden oder den Tod von Personen zur Folge haben können.



CAUTION

Die Kennzeichnung Caution (Vorsicht) beschreibt Gefahrenquellen die Schäden am Gerät hervorrufen können.

Begriffe auf dem Produkt. Diese Bedingungen können auf dem Produkt erscheinen:

DANGER weist auf eine Verletzung oder Gefährdung hin, die sofort geschehen kann.

WARNING weist auf eine Verletzung oder Gefährdung hin, die möglicherweise nicht sofort geschehen.

CAUTION weist auf eine Verletzung oder Gefährdung hin und bedeutet, dass eine mögliche Beschädigung des Instruments oder anderer Gegenstände auftreten kann.

Symbole auf dem Produkt. Diese Symbole können auf dem Produkt erscheinen:



**GefährlicheS
pannung**



**Sicherheits-
Hinweis**



Schutz-erde



Gehäusemasse



Erde

Document Overview

This manual guides users to correctly test the performance specifications of **RIGOL** DSG3000 series RF signal generator. For the operation method of the instrument, please refer to the corresponding User's Guide.

Main contents in this manual

Chapter 1 Overview

This chapter introduces the preparations and precautions of the performance verification test.

Chapter 2 Performance Verification Test

This chapter introduces the limit, test devices, test method and procedures of each performance specification.

Appendix Test Record Form

In the appendix, a test record form is provided for recording the test results so as to determine whether each performance specification fulfills the requirement.

Format Conventions in this Manual

- 1. Button:**
The key at the front panel is denoted by the following format: "Text Box + Button Name (Bold)" in the manual, for example, **FREQ** denotes the **FREQ** key.
- 2. Menu:**
The menu is denoted by the following format: "Character Shading + Menu Word (Bold)" in the manual, for example, **Frequency** denotes the frequency item under **FREQ**.
- 3. Connector:**
The connector at the front or rear panel is denoted by the following format: "Square Brackets + Connector Name (Bold)" in the manual, for example, **[RF OUTPUT 50Ω]**.
- 4. Operation Steps:**
The next step of the operation is denoted by an arrow "→" in the manual. For example, **FREQ** → **Frequency** denotes pressing **FREQ** on the front panel and then pressing **Frequency**.

Content Conventions in this Manual

The DSG3000 series RF signal generator includes the models DSG3030 and DSG3060.

Model	Frequency Range
DSG3030	9kHz to 3GHz
DSG3060	9kHz to 6GHz

Contents

Guaranty and Declaration	I
General Safety Summary	II
Safety Terms and Symbols	IV
Allgemeine Sicherheits Informationen.....	V
Sicherheits Begriffe und Symbole	VII
Document Overview.....	VIII
Chapter 1 Overview.....	1-1
Test Preparations.....	1-1
Test Result Record.....	1-2
Specifications.....	1-2
Chapter 2 Performance Verification Test.....	2-1
10 MHz Reference Output Accuracy Test.....	2-2
Specification.....	2-2
Test Devices.....	2-2
Test Connection Diagram.....	2-2
Test Procedures.....	2-2
Test Record Form.....	2-2
Single-sideband Phase Noise Test.....	2-3
Specification.....	2-3
Test Devices.....	2-3
Test Connection Diagram.....	2-3
Test Procedures.....	2-3
Test Record Form.....	2-4
Amplitude Accuracy Test.....	2-5
Specification.....	2-5
Test Devices.....	2-5
Test Connection Diagram.....	2-5
Test Procedures.....	2-6
Test Record Form.....	2-8
Second Harmonic Distortion Test.....	2-10
Specification.....	2-10
Test Devices.....	2-10
Test Connection Diagram.....	2-10
Test Procedures.....	2-10
Test Record Form.....	2-11
AM Internal Modulation Test.....	2-12
Specification.....	2-12

Test Devices.....	2-12
Test Connection Diagram.....	2-12
Test Procedures.....	2-12
Test Record Form	2-13
FM Internal Modulation Test	2-14
Specification.....	2-14
Test Devices.....	2-14
Test Connection Diagram.....	2-14
Test Procedures.....	2-14
Test Record Form	2-15
ØM Internal Modulation Test	2-16
Specification.....	2-16
Test Devices.....	2-16
Test Connection Diagram.....	2-16
Test Procedures.....	2-16
Test Record Form	2-17
AM External Modulation Test	2-18
Specification.....	2-18
Test Devices.....	2-18
Test Connection Diagram.....	2-18
Test Procedures.....	2-18
Test Record Form	2-19
FM External Modulation Test.....	2-20
Specification.....	2-20
Test Devices.....	2-20
Test Connection Diagram.....	2-20
Test Procedures.....	2-20
Test Record Form	2-21
ØM External Modulation Test	2-22
Specification.....	2-22
Test Devices.....	2-22
Test Connection Diagram.....	2-22
Test Procedures.....	2-22
Test Record Form	2-23
Pulse Modulation Test	2-24
Specification.....	2-24
Test Devices.....	2-24
Test Connection Diagram.....	2-24
Test Procedures.....	2-24
Test Record Form	2-25
I/Q Modulation Test.....	2-26
Specification.....	2-26
Test Devices.....	2-26
Test Connection Diagram.....	2-26

Test Procedures	2-26
Test Record Form.....	2-29
Appendix Test Record Form	1

Chapter 1 Overview

Test Preparations

Before performing the test, make the following preparations.

1. The RF signal generator is stored at least two hours within the temperature range of 0°C to 50°C, and is warmed up for 40 minutes.
2. Make sure that the instrument is within the calibration period (1 year).
3. The test devices required should fulfill the requirements of the “specification” section as shown in Table 1-1. You can also use the recommended models in the following table to measurement.

Table 1-1 Test Devices Required

Device	Specification	Qty.	Recommended
Receiver or Signal Analyzer	Total Amplitude Uncertainty: $< \pm 0.5$ dB SWR (9 kHz to 6 GHz): < 1.3 With phase noise test, analog demodulation and IQ demodulation functions	1	R&S FSMR or Agilent N9030A
Frequency Counter	Frequency Range: 10 MHz \pm 100 Hz Frequency Resolution: 10 digits/s	1	Agilent 53132A (with option 012) or 53220A (with option 010)
Power Sensor and Power Meter	Frequency Range: 9 kHz to 6 GHz SWR (9 kHz to 6 GHz): < 1.1 Amplitude Range: -40 dBm to +20 dBm Amplitude Uncertainty (-20 dBm to 0 dBm, 9 kHz to 6 GHz): $< \pm 1\%$ Resolution: 0.001 dB Reference Accuracy: $\pm 1\%$	1	Agilent E9304A, Agilent N1913A or E4418B
Function/Arbitrary Waveform Generator	Max Output Frequency: > 1 MHz Flatness (< 1 MHz): ± 0.3 dB Amplitude Accuracy (amplitude is 2 Vpp): $< \pm 30$ mV	1	RIGOL DG4162 or DG4062
Dual-N Cable	N-type (male) to N-type (male) cable Frequency Range: DC to 6 GHz SWR: < 1.1 Insertion Loss: < 1 dB	1	—
Dual-BNC Cable	BNC (male)-BNC (male) cable	2	—
USB Cable	USB(A)-USB(B) cable	1	—

Test Result Record

Record and keep the test result of each test. In the Appendix of this manual, a test result record form which lists all the test items and their corresponding performance limits as well as spaces for users to record the test results, is provided.

Tip:

It is recommended that users photocopy the test record form before each test and record the test results in the copy so that the form can be used repeatedly.

Specifications

The specification of each test item is provided in chapter 2. For other specifications, refer to *DSG3000 User's Guide* or *DSG3000 Data Sheet* (can be downloaded from www.rigol.com).

Tip:

All the specifications are only valid when the instrument has been warmed up for more than 40 minutes.

Chapter 2 Performance Verification Test

This chapter introduces the performance verification test method and procedures of DSG3000 series RF signal generator.

Note:

- 1) Make sure that the instrument has been warmed up for at least 40 minutes before executing any of the following tests.
- 2) Reset the instrument to the factory setting before or after executing any of the following tests.
- 3) Definitions of "Typical Value", "Nominal Value" and "Measured value" for this product.
 - **Typical (typ.):** describes characteristic performance, which 80 percent of the measurement results will meet at room temperature (approximately 25°C). This data is not warranted, does not include measurement uncertainty.
 - **Nominal (nom.):** indicates the expected mean or average performance, or an attribute whose performance is by design, such as the 50 ohm connector. This data is not warranted and is measured at room temperature (approximately 25°C).
 - **Measured (meas.):** describes an attribute measured during the design phase for purposes of communicating expected performance, such as amplitude drift vs. time. This data is not warranted and is measured at room temperature (approximately 25°C).

10 MHz Reference Output Accuracy Test

Specification

10 MHz Reference Output Accuracy	
Specification	Aging rate ^[1] × time from last calibration till now ^[2] + temperature drift ^[3]

Note:

- [1] Aging rate: < 1 ppm/year
- [2] The instrument was calibrated before leaving factory
- [3] Temperature drift: < 0.5 ppm

Test Devices

- 1. Frequency Counter × 1
- 2. Dual-BNC Cable × 1

Test Connection Diagram



Figure 2-1 10 MHz Reference Output Accuracy Test Connection Diagram

Test Procedures

- 1. Connect the [10 MHz OUT] terminal at the rear panel of the DSG3000 with the frequency counter, as shown in Figure 2-1.
- 2. Record the measurement result of the frequency counter and compare it with the specification.

Test Record Form

Frequency Counter Measurement Result	Output Accuracy ^[1]	Limit	Pass/Fail
		< 10 MHz × (1 ppm × time from the last calibration till now + 0.5 ppm)	

Note: [1] Output Accuracy = |Frequency Counter Measurement Result - 10 MHz|

Single-sideband Phase Noise Test

Specification

Single-sideband Phase Noise			
Carrier Offset	Frequency	DSG3030	DSG3060
20 kHz	100 MHz	< -120 dBc/Hz	< -120 dBc/Hz
	1 GHz	< -108 dBc/Hz	< -108 dBc/Hz
	3 GHz	< -102 dBc/Hz	< -102 dBc/Hz
	6 GHz	—	< -96 dBc/Hz

Test Devices

1. Signal Analyzer × 1
2. Dual-N Cable × 1
3. Dual-BNC Cable × 1

Test Connection Diagram

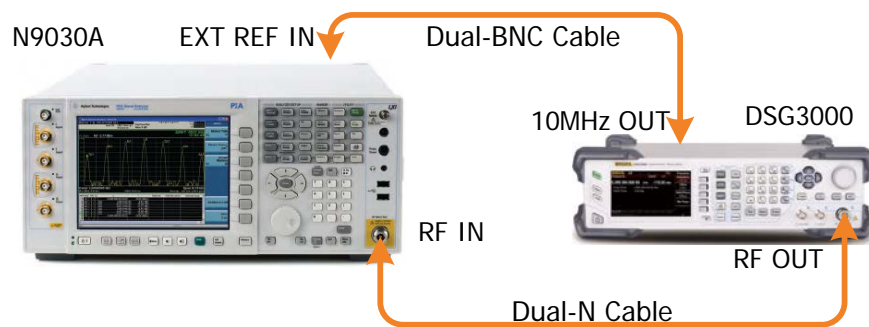

Figure 2-2 Single-sideband Phase Noise Test Connection Diagram

Test Procedures

1. Connect the **[10MHz OUT]** terminal of the DSG3000 with the **[EXT REF IN]** terminal at the rear panel of the signal analyzer using dual-BNC cable to synchronize the two instruments.
2. Connect the RF output terminal of the DSG3000 with the RF input terminal of the signal analyzer.
3. Set the DSG3000 to output a sine waveform with 1 GHz frequency and 0 dBm amplitude. Then, enable the RF output switch **[RF]**.
4. Configure the signal analyzer:
 - a) Set the frequency reference input to external.

- b) Set the center frequency to 1 GHz.
 - c) Set the span to 50 kHz.
 - d) Set the resolution bandwidth to 1 kHz.
 - e) Set the video bandwidth to 3 Hz.
 - f) Set the reference level to 0 dBm.
 - g) Set the input attenuation to 10 dB.
 - h) Set the trace type to clear write.
 - i) Set the detector type to RMS average.
 - j) Set the sweep time to auto.
5. Press **Single**, wait for the instrument to finish a sweep and press **Peak Search** to find the maximum peak.
 6. Press **Marker** → **Delta** → input 20 kHz. Press **Single** and wait for the instrument to finish the sweeps. Press **Marker Function** → **Marker Noise**, read the current measurement result and record it to the test record form.
 7. Press **Mode Preset** to reset the signal analyzer to the factory setting. Set the output frequency of the DSG3000 according to Table 2-1, repeat steps 4 to 6 (note that modify the center frequency of the signal analyzer accordingly in step 4 each time the output frequency of the DSG3000 is modified), and record the result.

Table 2-1 Output Frequency of the DSG3000

Output Frequency		
100 MHz	3 GHz	6 GHz (only DSG3060)

8. Compare the measurement result with the specification.

Test Record Form

DSG3000 Output Frequency	Offset	Measurement Result	Limit	Pass/Fail	
100 MHz	Offset 20 KHz		< -120 dBc/Hz		
1 GHz	Offset 20 KHz		< -108 dBc/Hz		
3 GHz	Offset 20 KHz		< -102 dBc/Hz		
6 GHz (only DSG3060)	Offset 20 KHz		< -96 dBc/Hz		

Amplitude Accuracy Test

Specification

Absolute Level Uncertainty			
ALC state: on or auto mode, Temperature range: 20°C to 30°C			
	+13 dBm ~ -60 dBm	-60 dBm ~ -110 dBm	-110 dBm ~ -130 dBm
9 kHz ≤ f < 100 kHz	≤ 0.5 dB (typ.)	≤ 0.7 dB (typ.)	—
100 kHz ≤ f ≤ 3 GHz	≤ 0.7 dB, ≤ 0.5 (typ.)	≤ 0.9 dB, ≤ 0.5 (typ.)	≤ 0.7 dB (typ.)
3 GHz < f ≤ 6 GHz	≤ 0.9 dB, ≤ 0.5 (typ.)	≤ 1.1 dB, ≤ 0.5 (typ.)	≤ 0.9 dB (typ.)

Test Devices

1. Power Meter and Power Sensor × 1
2. Dual-N Cable × 1
3. Dual-BNC Cable × 1
4. Signal Analyzer × 1

Test Connection Diagram

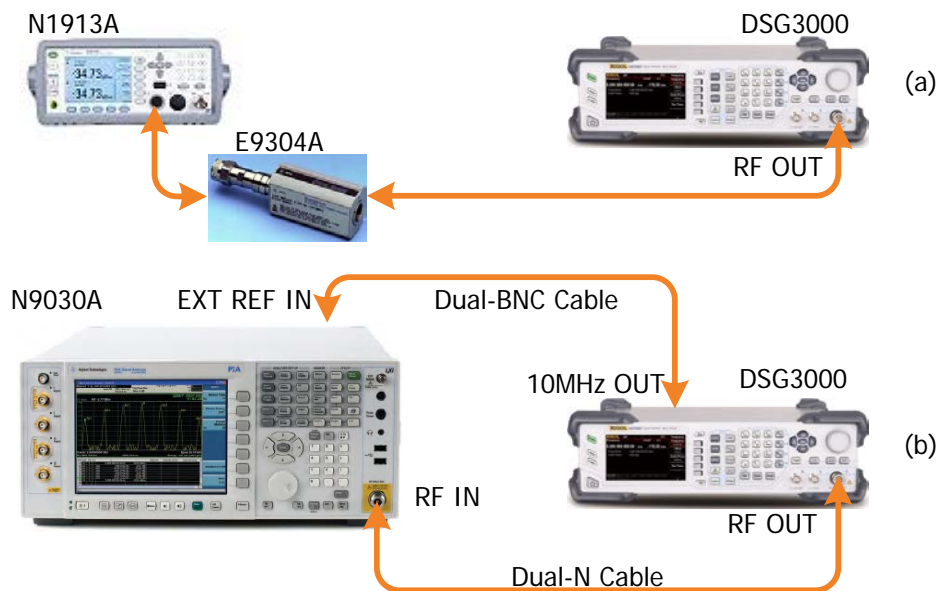

Figure 2-3 Amplitude Accuracy Test Connection Diagram

Test Procedures

1. Calibrate the power meter:
 - a) Connect the power sensor with the **[REF]** terminal and channel A of the power meter. Press **Channel** and set the frequency of channel A to 50 MHz.
 - b) Press **Cal** and enable **Power Ref** in the **Zero/Cal** menu. Press **Zero+Cal** and wait for the calibration to finish; then, observe whether the measurement value of the power meter is a 0 dBm, 50 MHz signal.
 - c) Disable **Power Ref**.
2. Connect the output terminal of the DSG3000 with the power sensor, as shown in Figure 2-3 (a).
3. Set the DSG3000 to output a sine waveform with -10 dBm amplitude. Then modify the output frequency of the DSG3000 according to Table 2-2 and enable the RF output switch **RF**.

Table 2-2 Output Frequency of the DSG3000

Model	Output Frequency						
DSG3060	103 kHz	1.03 MHz	50.03 MHz	503 MHz	1.903 GHz	2.493 GHz	2.903 GHz
	3.493 GHz	3.903 GHz	4.493 GHz	4.903 GHz	5.493 GHz	5.903 GHz	—
DSG3030	103 kHz	1.03 MHz	50.03 MHz	503 MHz	1.903 GHz	2.493 GHz	2.903 GHz

Note: when the frequency of the signal measured is less than 10MHz, you need to switch the signal analyzer to DC coupling mode to ensure the measurement accuracy.

4. Modify the frequency of the power meter accordingly each time the output frequency of the DSG3000 is modified. Read the amplitude measurement value **A1** and record it to the test record form.
5. Disconnect the DSG3000 and the power meter. Connect the **[10MHz OUT]** terminal of the DSG3000 with the **[EXT REF IN]** terminal at the rear panel of the signal analyzer using dual-BNC cable to synchronize the two instruments.
6. Connect the output terminal of the DSG3000 with the input terminal of the signal analyzer using dual-N cable as shown in Figure 2-3(b).
7. Configure the signal analyzer:
 - a) Select the external frequency reference input.
 - b) Set the span to 100 Hz.
 - c) Set the reference level to -20 dBm.
 - d) Set the input attenuation to 10 dB.
 - e) Set the resolution bandwidth to 1 Hz.
 - f) Set the self-calibration to normal and perform all of the calibration items.

8. Set the output frequency of the DSG3000 and the center frequency of the signal analyzer according to Table 2-2 (the center frequency of the signal analyzer corresponds to output frequency of the DSG3000).
9. Each time the center frequency is changed, press **Single**, wait for the instrument to finish a sweep and press **Peak Search** to find the maximum peak. Then record the result **A2** to the test record form.
10. **System Error** (the input attenuation of the signal analyzer is 10 dB) = **A2 - A1** and record the measurement result.
11. Keep the connection shown in Figure 2-3 (b) unchanged, press **Mode Preset** to restore the signal analyzer to its factory setting and set the output amplitude of the DSG3000 according to Table 2-3.

Table 2-3 Output Amplitude of the DSG3000

Output Amplitude		
-10 dBm	-50 dBm	-90 dBm

Note: the output amplitude of the DSG3000 is set to the **Reference Value**. And different output amplitudes correspond to different reference values.

12. Each time the output amplitude of the DSG3000 is changed, set the output frequency of the DSG3000 and the center frequency of the signal analyzer according to Table 2-2 (the center frequency of the signal analyzer corresponds to output frequency of the DSG3000).
13. Each time the center frequency is changed, press **Single** and wait for the instrument to finish a sweep; then, press **Peak Search** to find the maximum peak and record the measurement result **A3** to the test record form.

Note: when the output amplitude of the DSG3000 is -10 dBm, the measurement result **A3**, namely, the measurement value **A2** of the signal analyzer in step 9.

14. Calculate the **Global Error = A3 - Reference Value** and record the result.
15. Calculate the amplitude accuracy using the formula **Amplitude Accuracy = | Global Error - System Error |** and compare the calculation result with the specification.

Test Record Form

DSG3000 Output Frequency	Power Meter Measurement Value A1	Signal Analyzer Measurement Value A2	System Error ^[1]
103 kHz			
1.03 MHz			
50.03 MHz			
503 MHz			
1.903 GHz			
2.493 GHz			
2.903 GHz			
3.493 GHz			
3.903 GHz			
4.493 GHz			
4.903 GHz			
5.493 GHz			
5.903 GHz			

Reference Value	-10 dBm				
DSG3000 Output Frequency	Signal Analyzer Measurement Value A3 (A2)	Global Error ^[2]	Amplitude Accuracy ^[3]	Limit	Pass/ Fail
103 kHz				≤0.7 dB	
1.03 MHz					
50.03 MHz					
503 MHz					
1.903 GHz					
2.493 GHz					
2.903 GHz				≤0.9 dB	
3.493 GHz					
3.903 GHz					
4.493 GHz					
4.903 GHz					
5.493 GHz					
5.903 GHz					

Reference Value	-50 dBm				
DSG3000 Output Frequency	Signal Analyzer Measurement Value A3	Global Error ^[2]	Amplitude Accuracy ^[3]	Limit	Pass/Fail
103 kHz				≤0.7 dB	
1.03 MHz					
50.03 MHz					
503 MHz					
1.903 GHz					
2.493 GHz					
2.903 GHz					
3.493 GHz				≤0.9 dB	
3.903 GHz					
4.493 GHz					
4.903 GHz					
5.493 GHz					
5.903 GHz					

Reference Value	-90 dBm				
DSG3000 Output Frequency	Signal Analyzer Measurement Value A3	Global Error ^[2]	Amplitude Accuracy ^[3]	Limit	Pass/Fail
103 kHz				≤0.9 dB	
1.03 MHz					
50.03 MHz					
503 MHz					
1.903 GHz					
2.493 GHz					
2.903 GHz					
3.493 GHz				≤1.1 dB	
3.903 GHz					
4.493 GHz					
4.903 GHz					
5.493 GHz					
5.903 GHz					

Note:

[1] System Error = A2 - A1

[2] Global Error = A3 - Reference Value

[3] Amplitude Accuracy = |Global Error - System Error|

Second Harmonic Distortion Test

Specification

Second Harmonic Distortion	
Model	DSG3030/DSG3060
Specification	<-30dBc

Test Devices

1. Signal Analyzer × 1
2. Dual-BNC Cable × 1
3. Dual-N Cable × 1

Test Connection Diagram

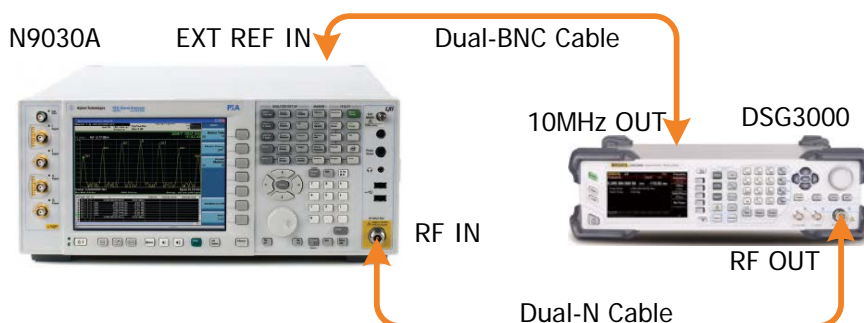

Figure 2-4 Second Harmonic Distortion Test Connection Diagram

Test Procedures

1. Synchronize the DSG3000 and signal analyzer. Connect the RF output terminal of the DSG3000 with the RF input terminal of the signal analyzer as shown in Figure 2-4.
2. Set the output frequency of the DSG3000 to **F0** according to Table 2-4 and the amplitude to +10 dBm. Enable the RF output switch **RF**.

Table 2-4 Output Frequency of the DSG3000

Output Frequency (F0)				
10 MHz	500 MHz	1 GHz	2 GHz	5 GHz (only DSG3060)

3. Configure the signal analyzer:
 - a) Set the center frequency to **F0**.
 - b) Set the span to 10 kHz.

- c) Set the reference level to 20 dBm.
- d) Set the input attenuation to 30 dB.
- e) Set the resolution bandwidth to 30 Hz.
- f) Set the video bandwidth to 10 Hz.

Note: modify the center frequency of the signal analyzer accordingly each time the output frequency of the DSG3000 is changed (the center frequency of the signal analyzer corresponds to output frequency of the DSG3000).

4. Press **Single** and wait for the instrument to finish a sweep; press **Peak Search** to find the maximum peak. Then, set the cursor type to Delta. Set the center frequency to $2 \times F_0$, press **Single** and wait for the instrument to finish a sweep; press **Peak Search** and record the delta result.
5. The delta value is the **Second Harmonic Distortion**. And compare the measurement result with the specification.

Test Record Form

DSG3000 Output Amplitude	+10 dBm		
DSG3000 Output Frequency	Delta	Limit	Pass/Fail
10 MHz		< -30 dBc	
500 MHz			
1 GHz			
2 GHz			
5 GHz (only DSG3060)			

AM Internal Modulation Test

Specification

AM		
Model	DSG3030/DSG3060	
Item	Condition	Specification
Modulation Accuracy	$f_{mod}=1\text{ kHz}$	$< \text{AM depth setting} \times 4\% + 1\%$
Distortion	$f_{mod}=1\text{ kHz}, m^{[1]} \leq 30\%, \text{ level} = 0\text{ dBm}$	$< 3\%$ (typ.)

Note: [1] m represents the AM depth.

Test Devices

1. Signal Analyzer × 1
2. Dual-BNC Cable × 1
3. Dual-N Cable × 1

Test Connection Diagram

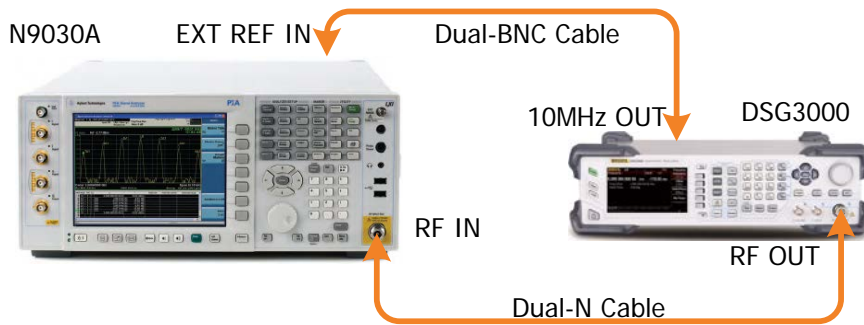

Figure 2-5 AM Internal Modulation Test Connection Diagram

Test Procedures

1. Synchronize the DSG3000 and signal analyzer. Connect the RF output terminal of the DSG3000 with the RF input terminal of the signal analyzer as shown in Figure 2-5.
2. Configure the DSG3000:
 - a) Set the frequency to 1 GHz.
 - b) Set the amplitude to -10 dBm.
 - c) Enable the RF output switch **RF**.
 - d) Enable the AM switch.
 - e) Set the modulation source to internal.

- f) Set the modulation depth to 30%.
 - g) Set the modulation frequency to 1 kHz.
 - h) Set the modulation waveform to "Sine".
 - i) Enable the modulation output switch **MOD**.
3. Configure the signal analyzer:
 - a) Set the center frequency to 1 GHz.
 - b) Set the span to 10 kHz.
 - c) Set the reference level to 0 dBm.
 - d) Set the input attenuation to 10 dB.
 - e) Set the resolution bandwidth to 100 Hz.
 - f) Set the video bandwidth to 100 Hz.
 - g) Select the AM analog demodulation.
 4. Press **Meas Setup** → **Auto Scale** and then read the results of the demodulated signal in the AM analog demodulation test interface of the signal analyzer. Record the measurement results **(Pk - Pk)/2** and **Distortion**.

Note: the value **(Pk - Pk)/2** represents the peak of the low frequency signal after AM demodulated.

5. Calculate the modulation accuracy and the distortion using the formulas: **Modulation Accuracy = |(Pk - Pk)/2 - 30%|**, **AM Distortion = Distortion** value. Then, compare the calculation results with the specifications.

Test Record Form

DSG3000 Output Frequency	Item	Measurement	Calculation Result	Limit	Pass/ Fail
1 GHz	Modulation Accuracy ^[1]			<AM depth setting × 4% + 1%	
	Distortion ^[2]			<3% (typ.)	

Note:

[1] Modulation Accuracy = |(Pk - Pk)/2 - 30%|

[2] AM distortion = Distortion value in the AM analog demodulation test interface

FM Internal Modulation Test

Specification

FM		
Model	DSG3030/DSG3060	
Item	Condition	Specification
Modulation Accuracy	$f_{\text{mod}}=1$ kHz, internal modulation source	< FM deviation setting \times 2% + 20 Hz
Distortion	$f_{\text{mod}}=1$ kHz, deviation = $N^{[1]} \times 50$ kHz	<2% (typ.)

Note: [1] please refer to the value of N in the "Frequency Bands" section of the *DSG3000 Data Sheet*.

Test Devices

1. Signal Analyzer \times 1
2. Dual-BNC Cable \times 1
3. Dual-N Cable \times 1

Test Connection Diagram

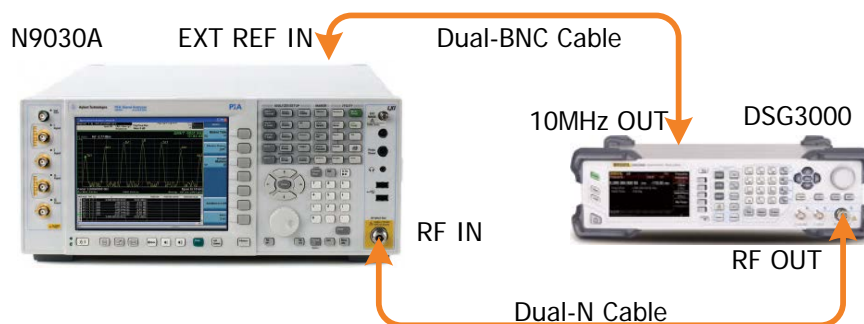

Figure 2-6 FM Internal Modulation Test Connection Diagram

Test Procedures

1. Synchronize the DSG3000 and signal analyzer. Connect the RF output terminal of the DSG3000 with the RF input terminal of the signal analyzer as shown in Figure 2-6.
2. Configure the DSG3000:
 - a) Set the frequency to 1 GHz.
 - b) Set the amplitude to -10 dBm.
 - c) Enable the RF output switch **RF**.
 - d) Select the FM modulation.
 - e) Enable the FM switch.

- f) Set the modulation source to internal.
 - g) Set the modulation deviation to 50 kHz.
 - h) Set the modulation rate to 1 kHz.
 - i) Set the modulation waveform to "Sine".
 - j) Enable the modulation output switch **MOD**.
3. Configure the signal analyzer:
 - a) Set the center frequency to 1 GHz.
 - b) Set the span to 200 kHz.
 - c) Set the reference level to 0 dBm.
 - d) Set the input attenuation to 10 dB.
 - e) Set the resolution bandwidth to 1 kHz.
 - f) Set the video bandwidth to 1 kHz.
 - g) Select the FM analog demodulation.
 4. Press **Meas Setup** → **Auto Scale** and then read the results of the demodulated signal in the FM analog demodulation test interface of the signal analyzer. Record the measurement results **(Pk - Pk)/2** and **Distortion**.

Note: the value **(Pk - Pk)/2** represents the peak of the low frequency signal after FM demodulated.
 5. Calculate the modulation accuracy and the distortion using the formulas: **Modulation Accuracy = |(Pk - Pk)/2 - 50 kHz|**, **FM Distortion = Distortion** value. Then, compare the calculation results with the specifications.

Test Record Form

DSG3000 Output Frequency	Item	Measurement	Calculation Result	Limit	Pass/Fail
1 GHz	Modulation Accuracy ^[1]			<FM deviation setting × 2% + 20 Hz	
	Distortion ^[2]			<2% (typ.)	

Note:

[1] Modulation Accuracy = |(Pk - Pk)/2 - 50 kHz|

[2] FM distortion = Distortion value in the FM analog demodulation test interface

ØM Internal Modulation Test

Specification

ØM		
Model	DSG3030/DSG3060	
Item	Condition	Specification
Modulation Accuracy	$f_{\text{mod}}=1$ kHz, internal modulation source	$< \text{ØM deviation setting} \times 1\% + 0.1$ rad
Distortion	$f_{\text{mod}}=1$ kHz, deviation = 5 rad	$< 1\%$ (typ.)

Test Devices

1. Signal Analyzer × 1
2. Dual-BNC Cable × 1
3. Dual-N Cable × 1

Test Connection Diagram

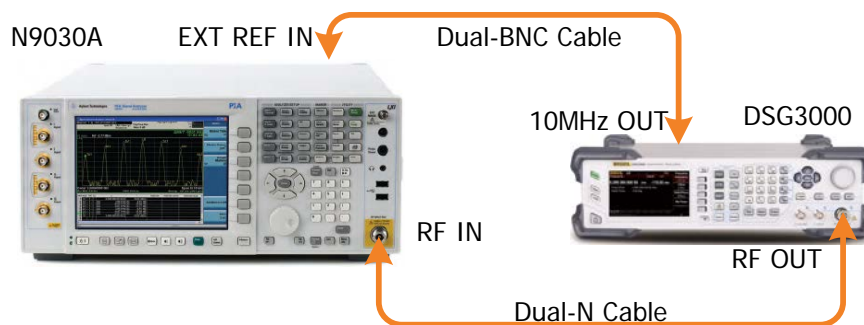

Figure 2-7 PM Internal Modulation Test Connection Diagram

Test Procedures

1. Synchronize the DSG3000 and signal analyzer. Connect the RF output terminal of the DSG3000 with the RF input terminal of the signal analyzer as shown in Figure 2-7.
2. Configure the DSG3000:
 - a) Set the frequency to 1 GHz.
 - b) Set the amplitude to -10 dBm.
 - c) Enable the RF output switch **RF**.
 - d) Select the ØM modulation.
 - e) Enable the ØM switch.
 - f) Set the modulation source to internal.

- g) Set the modulation deviation to 5 rad.
 - h) Set the modulation rate to 1 kHz.
 - i) Set the modulation waveform to "Sine".
 - j) Enable the modulation output switch **MOD**.
3. Configure the signal analyzer:
- a) Set the center frequency to 1 GHz.
 - b) Set the span to 200 kHz.
 - c) Set the reference level to 0 dBm.
 - d) Set the input attenuation to 10 dB.
 - e) Set the resolution bandwidth to 1 kHz.
 - f) Set the video bandwidth to 1 kHz.
 - g) Select the \emptyset M analog demodulation.
4. Press **Meas Setup** → **Auto Scale** and then read the results of the demodulated signal in the \emptyset M analog demodulation test interface of the signal analyzer. Record the measurement results **(Pk - Pk)/2** and **Distortion**.

Note: the value **(Pk - Pk)/2** represents the peak of the low frequency signal after \emptyset M demodulated.

5. Calculate the modulation accuracy and the distortion using the formulas: **Modulation Accuracy = |(Pk - Pk)/2 - 5 rad|**, **\emptyset M Distortion = Distortion** value. Then, compare the calculation results with the specifications.

Test Record Form

DSG3000 Output Frequency	Item	Measurement	Calculation Result	Limit	Pass/ Fail
1 GHz	Modulation Accuracy ^[1]			< \emptyset M deviation setting × 1% + 0.1 rad	
	Distortion ^[2]			<1% (typ.)	

Note:

[1] Modulation Accuracy = |(Pk - Pk)/2 - 5 rad|

[2] \emptyset M distortion = Distortion value in the \emptyset M analog demodulation test interface

AM External Modulation Test

Specification

AM		
Model	DSG3030/DSG3060	
Item	Condition	Specification
Frequency Response	$m^{[1]} \leq 80\%$, 10Hz to 50kHz	<3dB (nom.)

Note: [1] m represents the AM depth.

Test Devices

1. Signal Analyzer × 1
2. Function/Arbitrary Waveform Generator × 1
3. Dual-BNC Cable × 2
4. Dual-N Cable × 1

Test Connection Diagram

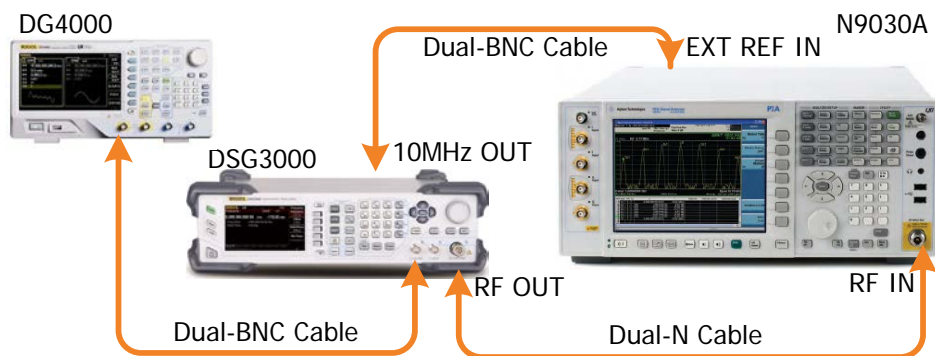

Figure 2-8 AM External Modulation Test Connection Diagram

Test Procedures

1. Synchronize the DSG3000 and signal analyzer. Connect the RF output terminal of the DSG3000 with the RF input terminal of the signal analyzer. Connect the signal output terminal (e.g. CH1 output) of the function/arbitrary waveform generator with the external modulation input terminal of the DSG3000 as shown in Figure 2-8.
2. Configure the DSG3000:
 - a) Set the frequency to 1 GHz.
 - b) Set the amplitude to -10 dBm.
 - c) Enable the RF output switch **RF**.
 - d) Enable the AM switch.

- e) Set the modulation source to external.
 - f) Set the modulation depth to 80%.
 - g) Enable the modulation output switch **MOD**.
3. Configure the signal analyzer:
 - a) Set the center frequency to 1 GHz.
 - b) Set the span to 10 kHz.
 - c) Set the reference level to 0 dBm.
 - d) Set the input attenuation to 10 dB.
 - e) Select the AM analog demodulation.
 4. Configure the function/arbitrary waveform generator:
 - a) Set the output resistance to high impedance.
 - b) Select the "Sine" waveform.
 - c) Set the frequency to 1 kHz.
 - d) Set the amplitude to 1 Vpp.
 - e) Enable the output switch.
 5. Press **Meas Setup** → **Auto Scale** and then read the results of the demodulated signal in the AM analog demodulation test interface of the signal analyzer. Record the measurement results **(Pk - Pk)/2** which is marked for **A1**.

Note: the value **(Pk - Pk)/2** represents the peak of the low frequency signal after AM demodulated.
 6. Set the frequency of the function/arbitrary waveform generator to 50 kHz.
 7. Press **Meas Setup** → **Auto Scale** and then read the results of the demodulated signal in the AM analog demodulation test interface of the signal analyzer. Record the measurement results **(Pk - Pk)/2** which is marked for **A2**.
 8. Calculate the frequency response using the formula **Frequency Response = | 20lg (A2/A1) | dB** and compare the calculation result with the specification.

Note: the frequency response is the amplitude difference of output signal 50 kHz modulation rate relative to 1 kHz rate, and expressed in dB.

Test Record Form

DSG3000 Output Frequency	Item	Measure -ment A1	Measure -ment A2	Calculation Result ^[1] (dB)	Limit	Pass/ Fail
1 GHz	Frequency Response				<3dB (nom.)	

Note: [1] Calculation Result = |20lg (A2/A1)| dB

FM External Modulation Test

Specification

FM		
Model	DSG3030/DSG3060	
Item	Condition	Specification
Frequency Response ^[1]	10Hz to 100kHz	<3dB (nom.)

Note: [1] Measured at 100 kHz deviation.

Test Devices

1. Signal Analyzer × 1
2. Function/Arbitrary Waveform Generator × 1
3. Dual-BNC Cable × 2
4. Dual-N Cable × 1

Test Connection Diagram

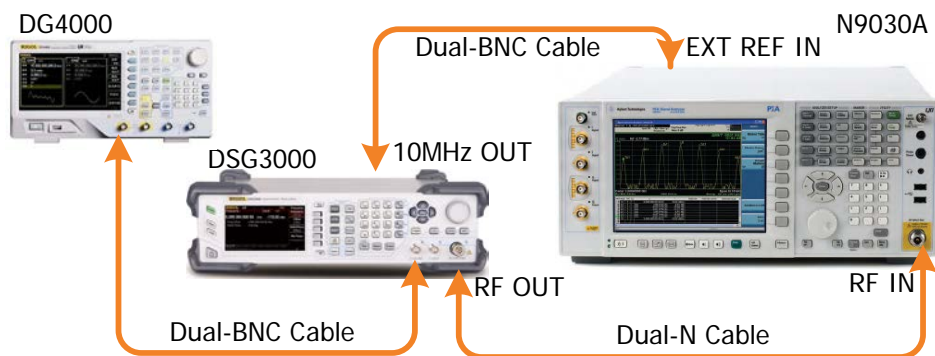

Figure 2-9 FM External Modulation Test Connection Diagram

Test Procedures

1. Synchronize the DSG3000 and signal analyzer. Connect the RF output terminal of the DSG3000 with the RF input terminal of the signal analyzer. Connect the signal output terminal (e.g. CH1 output) of the function/arbitrary waveform generator with the external modulation input terminal of the DSG3000 as shown in Figure 2-9.
2. Configure the DSG3000:
 - a) Set the frequency to 1 GHz.
 - b) Set the amplitude to -10 dBm.
 - c) Enable the RF output switch **RF**.
 - d) Select the FM modulation.

- e) Enable the FM switch.
 - f) Set the modulation source to external.
 - g) Set the modulation deviation to 100 kHz.
 - h) Enable the modulation output switch **MOD**.
3. Configure the signal analyzer:
 - a) Set the center frequency to 1 GHz.
 - b) Set the span to 10 kHz.
 - c) Set the reference level to 0 dBm.
 - d) Set the input attenuation to 10 dB.
 - e) Select the FM analog demodulation.
 4. Configure the function/arbitrary waveform generator:
 - a) Set the output resistance to high impedance.
 - b) Select the "Sine" waveform.
 - c) Set the frequency to 1 kHz.
 - d) Set the amplitude to 1 Vpp.
 - e) Enable the output switch.
 5. Press **Meas Setup** → **Auto Scale** and then read the results of the demodulated signal in the FM analog demodulation test interface of the signal analyzer. Record the measurement results **(Pk - Pk)/2** which is marked for **A1**.

Note: the value **(Pk - Pk)/2** represents the peak of the low frequency signal after FM demodulated.

6. Set the frequency of the function/arbitrary waveform generator to 100 kHz.
7. Press **Meas Setup** → **Auto Scale** and then read the results of the demodulated signal in the FM analog demodulation test interface of the signal analyzer. Record the measurement results **(Pk - Pk)/2** which is marked for **A2**.
8. Calculate the frequency response using the formula **Frequency Response = |20lg (A2/A1)| dB** and compare the calculation result with the specification.

Note: the frequency response is the amplitude difference of output signal 100 kHz modulation rate relative to 1 kHz rate, and expressed in dB.

Test Record Form

DSG3000 Output Frequency	Item	Measure-ment A1	Measure-ment A2	Calculation Result ^[1] (dB)	Limit	Pass/Fail
1 GHz	Frequency Response				<3dB (nom.)	

Note: [1] Calculation Result = |20lg (A2/A1)| dB

ØM External Modulation Test

Specification

ØM		
Model	DSG3030/DSG3060	
Item	Condition	Specification
Frequency Response ^[1]	10Hz to 100kHz	<3dB (nom.)

Note: [1] measured at 5 rad deviation.

Test Devices

- 1. Signal Analyzer × 1
- 2. Function/Arbitrary Waveform Generator × 1
- 3. Dual-BNC Cable × 2
- 4. Dual-N Cable × 1

Test Connection Diagram

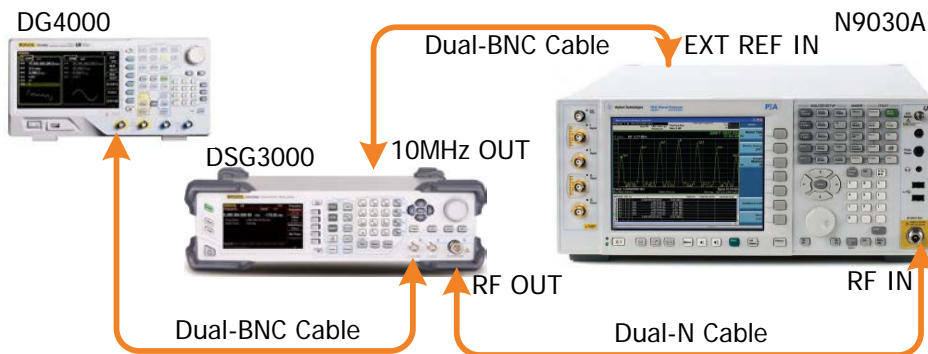

Figure 2-10 ØM External Modulation Test Connection Diagram

Test Procedures

- 1. Synchronize the DSG3000 and signal analyzer. Connect the RF output terminal of the DSG3000 with the RF input terminal of the signal analyzer. Connect the signal output terminal (e.g. CH1 output) of the function/arbitrary waveform generator with the external modulation input terminal of the DSG3000 as shown in Figure 2-10.
- 2. Configure the DSG3000:
 - a) Set the frequency to 1 GHz.
 - b) Set the amplitude to -10 dBm.
 - c) Enable the RF output switch **RF**.
 - d) Select the ØM modulation.

- e) Enable the ØM switch.
 - f) Set the modulation source to external.
 - g) Set the modulation deviation to 5 rad.
 - h) Enable the modulation output switch **MOD**.
3. Configure the signal analyzer:
 - a) Set the center frequency to 1 GHz.
 - b) Set the span to 10 kHz.
 - c) Set the reference level to 0 dBm.
 - d) Set the input attenuation to 10 dB.
 - e) Select the ØM analog demodulation.
 4. Configure the function/arbitrary waveform generator:
 - a) Set the output resistance to high impedance.
 - b) Select the "Sine" waveform.
 - c) Set the frequency to 1 kHz.
 - d) Set the amplitude to 1 Vpp.
 - e) Enable the output switch.
 5. Press **Meas Setup** → **Auto Scale** and then read the results of the demodulated signal in the ØM analog demodulation test interface of the signal analyzer. Record the measurement results **(Pk - Pk)/2** which is marked for **A1**.
- Note:** the value **(Pk - Pk)/2** represents the peak of the low frequency signal after ØM demodulated.
6. Set the frequency of the function/arbitrary waveform generator to 100 kHz.
 7. Press **Meas Setup** → **Auto Scale** and then read the results of the demodulated signal in the ØM analog demodulation test interface of the signal analyzer. Record the measurement results **(Pk - Pk)/2** which is marked for **A2**.
 8. Calculate the frequency response using the formula **Frequency Response = |20lg (A2/A1)| dB** and compare the calculation result with the specification.

Note: the frequency response is the amplitude difference of output signal 100 kHz modulation rate relative to 1 kHz rate, and expressed in dB.

Test Record Form

DSG3000 Output Frequency	Item	Measure-ment A1	Measure-ment A2	Calculation Result ^[1] (dB)	Limit	Pass/Fail
1 GHz	Frequency Response				<3dB (nom.)	

Note: [1] Calculation Result = |20lg (A2/A1)| dB

Pulse Modulation Test

Specification

Pulse Modulation		
Model	DSG3030/DSG3060	
Item	Condition	Specification
On/Off Ratio	25 MHz to 3 GHz	> 80dB
	3 GHz to 6 GHz	> 70dB

Test Devices

1. Signal Analyzer × 1
2. Dual-BNC Cable × 1
3. Dual-N Cable × 1

Test Connection Diagram

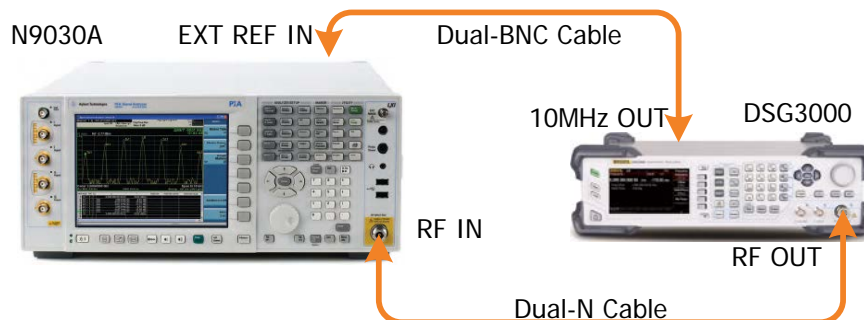

Figure 2-11 Pulse Modulation Test Connection Diagram

Test Procedures

1. Synchronize the DSG3000 and signal analyzer. Connect the RF output terminal of the DSG3000 with the RF input terminal of the signal analyzer as shown in Figure 2-11.
2. Configure the DSG3000:
 - a) Set the frequency to 1 GHz.
 - b) Set the amplitude to -10 dBm.
 - c) Enable the RF output switch **RF**.
 - d) Enable the pulse modulation switch.
 - e) Set the modulation source to internal.
 - f) Set the pulse mode to "Single".
 - g) Set the pulse period to 1 s.

- h) Set the pulse width to 0.5 s.
 - i) Set the trigger mode to "Auto".
 - j) Enable the modulation output switch **MOD**.
3. Configure the signal analyzer:
- a) Set the center frequency to 1 GHz.
 - b) Set the span to 0 Hz.
 - c) Set the reference level to 0 dBm.
 - d) Set the input attenuation to 10 dB.
 - e) Set the resolution bandwidth to 100 Hz.
 - f) Set the video bandwidth to 100 kHz.
 - g) Set the sweep time to 1 s.
 - h) Set the trigger mode to video trigger.
4. Press **Single** and wait for the instrument to finish a sweep; press **Peak Search** to find the maximum peak.
5. Press **Marker** → **Delta** → input 0.5s; press **Single** and wait for the instrument to finish a sweep. Read the current measurement result; calculate the **On/Off Ratio = - Delta**, and compare the calculation result with the specification.
6. If the model of the measured DSG3000 is DSG3060, press **Mode Preset** to reset the signal analyzer to the factory setting. Set the output frequency of the DSG3000 to 4 GHz (other parameters are not changed), and then, repeat steps 2 to 5. Record the measurement result and compare the calculation result with the specification.

Test Record Form

DSG3000 Output Frequency	Item	Measurement	Calculation Result ^[1]	Limit	Pass/Fail	
1 GHz	On/Off Ratio			>80 dB		
4 GHz (only DSG3060)	On/Off Ratio			>70 dB		

Note: [1] Calculation Result = - Delta.

I/Q Modulation Test

Specification

I/Q Modulation		
Model	DSG3030/DSG3060	
Item	Condition	Specification
EVM	50 MHz to 3 GHz (level ≤4 dBm)	≤0.7 %rms (typ.)
	3 GHz to 6 GHz (level ≤0 dBm)	≤1.2 %rms (typ.)

Test Devices

1. Signal Analyzer × 1
2. Dual-BNC Cable × 1
3. Dual-N Cable × 1
4. USB Cable × 1

Test Connection Diagram

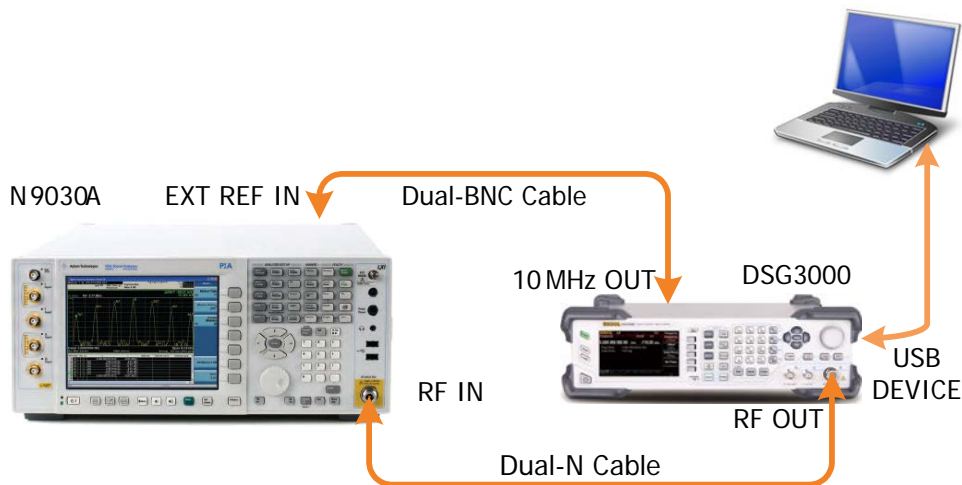
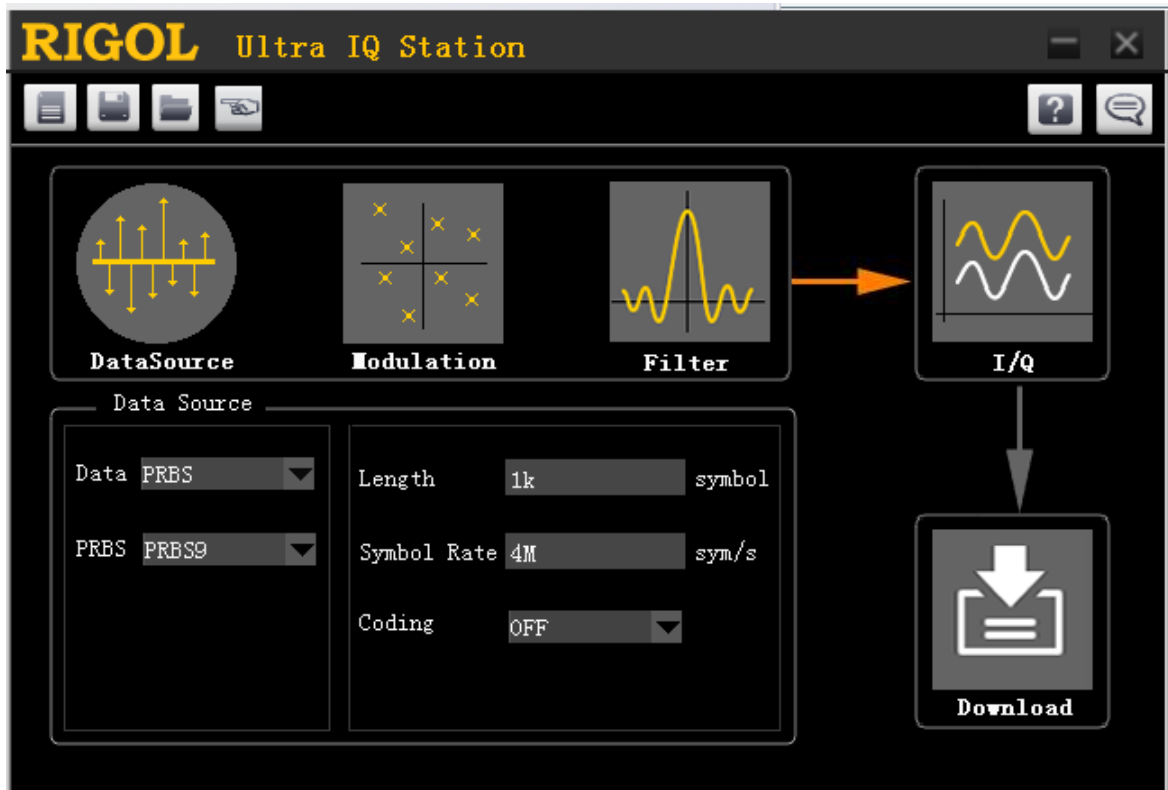

Figure 2-12 I/Q Modulation Test Connection Diagram

Test Procedures

1. Synchronize the DSG3000 and signal analyzer. Connect the RF output terminal of the DSG3000 with the RF input terminal of the signal analyzer. Connect the **[USB DEVICE]** connector of the DSG3000 with the USB interface of the PC as shown in Figure 2-12.
2. Install the Ultra IQ Station software to the PC. For more information about how to install the software, please refer to *Ultra IQ Station PC Software Installation and Operation*.

3. Configure the IQ modulation wave table using the Ultra IQ Station software:
 - a) Configure the wave table data.



- b) Configure the modulation type of the wave table.

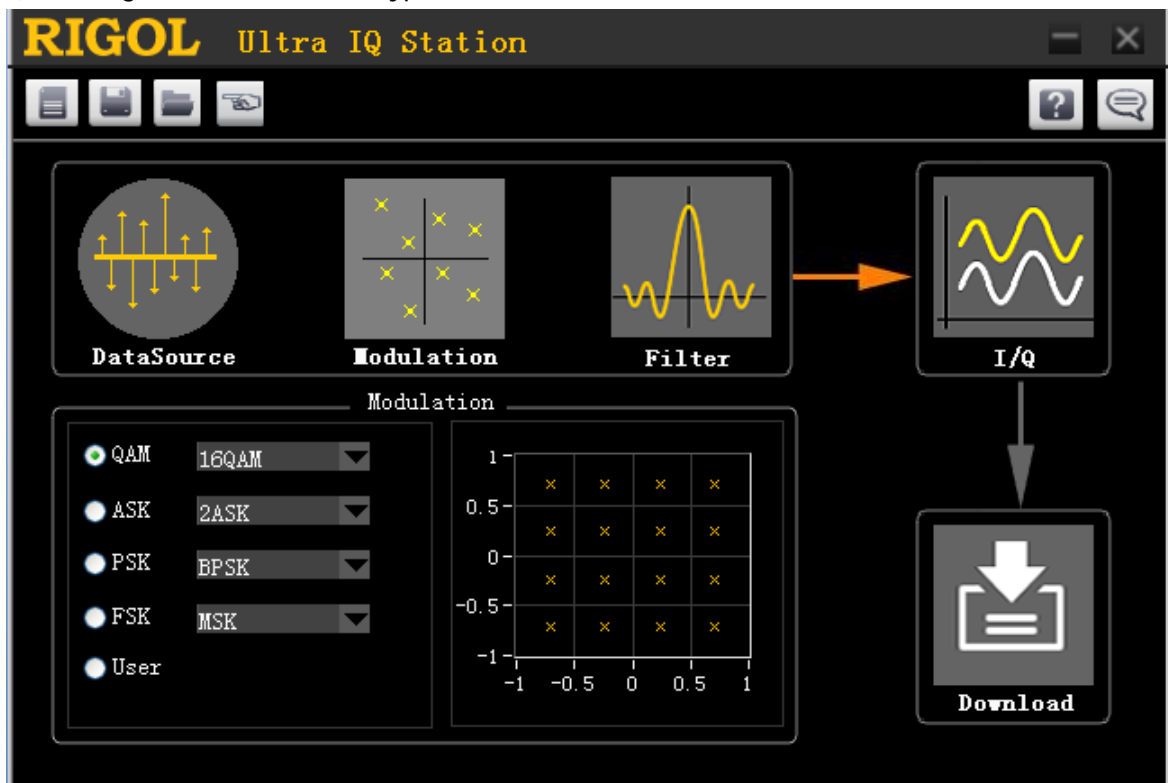

- c) Configure the filter parameter of the wave table.

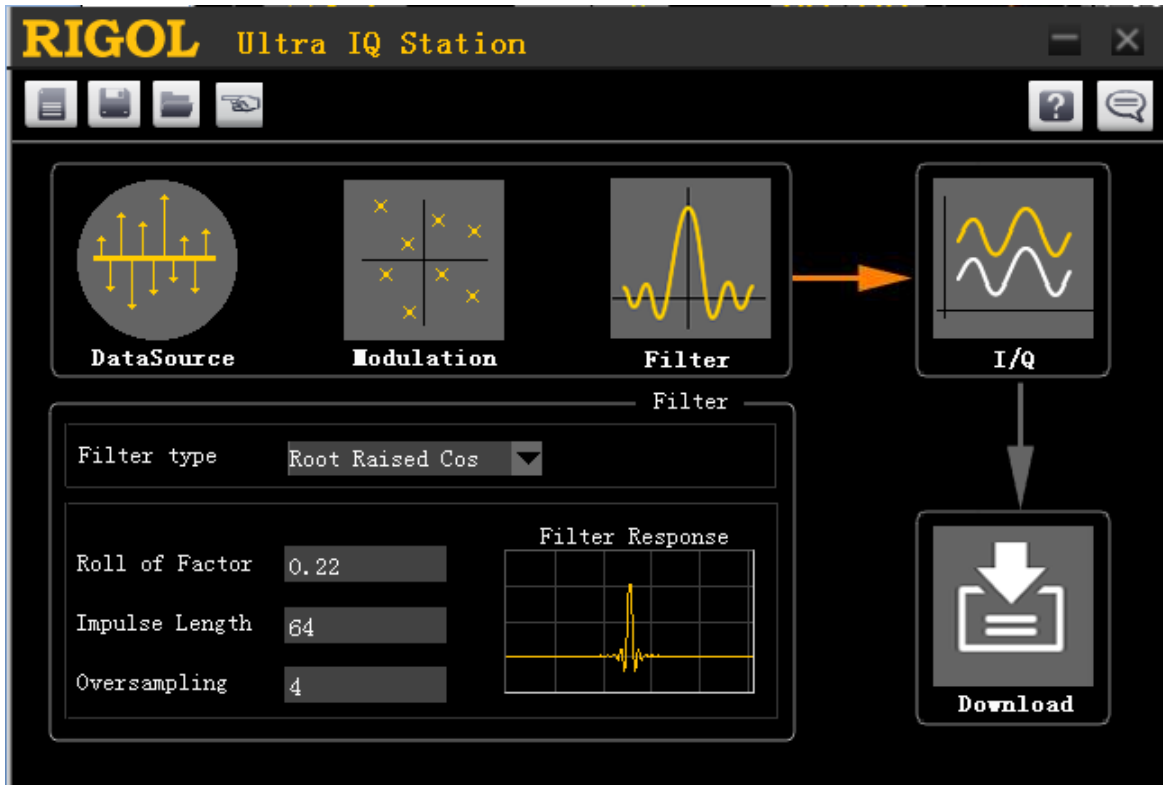

- d) Download the currently generated wave table to the DSG3000. For more information about how to download a wave table, please refer to *Ultra IQ Station Help Document*.

4. Configure the DSG3000:
 - a) Set the frequency to 800 MHz.
 - b) Set the amplitude to 3 dBm.
 - c) Press **I/Q** to enter the IQ modulation settings interface.
 - d) Enable the IQ modulation switch.
 - e) Set the modulation source to internal.
 - f) Enable the modulation output switch **MOD**.
 - g) Enable the RF output switch **RF**.

5. Configure the signal analyzer:
 - a) Set the center frequency to 800 MHz.
 - b) Press **Mode** → **Vector Signal Analyzer (VXA)** to enter the vector signal analysis interface.
 - c) Press **Meas** → **Digital Demod** to select the digital demodulation mode.
 - d) Press **Meas Setup** → **Demod Setup** → **Modulation** to enter the custom demodulation interface.
 - e) Press **QAM Formats** to select QAM16.
 - f) Set **Symbol Rate** to 4 MHz.
 - g) Select the filter type to **Root Raised Cosine**.
 - h) Select the reference filter to **Raised Cosine**.
 - i) Set the roll of factor (α) to 0.22.

6. Read the EVM value. And adjust the reference level of the signal analyzer until the EVM value has reached the minimum.
7. Record the current EVM value and compare the result with the specification.
8. Press **Mode Preset** to reset the signal analyzer to the factory setting. Set the output frequency of the DSG3000 according to Table 2-5.

Table 2-5 Output Frequency of the DSG3000

Output Frequency	
2.4 GHz	5.8 GHz (only DSG3060)

9. Modify the center frequency of the signal analyzer accordingly each time the output frequency of the DSG3000 is changed (the center frequency of the signal analyzer corresponds to output frequency of the DSG3000).
10. Keep other parameters unchanged and repeat steps 5 to 7. Record measurement result and compare it with the specification.

Test Record Form

DSG3000 Output Frequency	Item	Measurement	Limit	Pass/Fail	
800 MHz	EVM ^[1]		≤0.7 %rms (typ.)		
2.4 GHz			≤0.7 %rms (typ.)		
5.8 GHz (only DSG3060)			≤1.2 %rms (typ.)		

Note: [1] The parameter is measured at 16QAM, root cosine filter ($\alpha = 0.22$), sample rate 4MSps.

Appendix Test Record Form

RIGOL DSG3000 Series RF Signal Generator Performance Verification Test Record Form

Model: _____ Tested By: _____ Test Date: _____

10 MHz Reference Output Accuracy Test:

Frequency Counter Measurement Result	Output Accuracy ^[1]	Limit	Pass/Fail
		< 10 MHz × (1 ppm × time from the last calibration till now + 0.5 ppm)	

Note: [1] Output Accuracy = |Frequency Counter Measurement Result - 10 MHz|

Single-sideband Phase Noise Test:

DSG3000 Output Frequency	Offset	Measurement Result	Limit	Pass/Fail
100 MHz	Offset 20 KHz		< -120 dBc/Hz	
1 GHz	Offset 20 KHz		< -108 dBc/Hz	
3 GHz	Offset 20 KHz		< -102 dBc/Hz	
6 GHz (only DSG3060)	Offset 20 KHz		< -96 dBc/Hz	

Amplitude Accuracy Test:

DSG3000 Output Frequency	Power Meter Measurement Value A1	Signal Analyzer Measurement Value A2	System Error ^[1]
103 kHz			
1.03 MHz			
50.03 MHz			
503 MHz			
1.903 GHz			
2.493 GHz			
2.903 GHz			
3.493 GHz			
3.903 GHz			
4.493 GHz			
4.903 GHz			
5.493 GHz			
5.903 GHz			

Amplitude Accuracy Test (Continue):

Reference Value	-10 dBm				
DSG3000 Output Frequency	Signal Analyzer Measurement Value A3 (A2)	Global Error ^[2]	Amplitude Accuracy ^[3]	Limit	Pass/Fail
103 kHz				≤0.7 dB	
1.03 MHz					
50.03 MHz					
503 MHz					
1.903 GHz					
2.493 GHz					
2.903 GHz					
3.493 GHz				≤0.9 dB	
3.903 GHz					
4.493 GHz					
4.903 GHz					
5.493 GHz					
5.903 GHz					

Reference Value	-50 dBm				
DSG3000 Output Frequency	Signal Analyzer Measurement Value A3	Global Error ^[2]	Amplitude Accuracy ^[3]	Limit	Pass/Fail
103 kHz				≤0.7 dB	
1.03 MHz					
50.03 MHz					
503 MHz					
1.903 GHz					
2.493 GHz					
2.903 GHz					
3.493 GHz				≤0.9 dB	
3.903 GHz					
4.493 GHz					
4.903 GHz					
5.493 GHz					
5.903 GHz					

Amplitude Accuracy Test (Continue):

Reference Value	-90 dBm				
DSG3000 Output Frequency	Signal Analyzer Measurement Value A3	Global Error ^[2]	Amplitude Accuracy ^[3]	Limit	Pass/Fail
103 kHz				≤0.9 dB	
1.03 MHz					
50.03 MHz					
503 MHz					
1.903 GHz					
2.493 GHz					
2.903 GHz					
3.493 GHz				≤1.1 dB	
3.903 GHz					
4.493 GHz					
4.903 GHz					
5.493 GHz					
5.903 GHz					

Note:

[1] System Error = A2 - A1

[2] Global Error = A3 – Reference Value

[3] Amplitude Accuracy = |Global Error - System Error|

Second Harmonic Distortion Test:

DSG3000 Output Amplitude	+10 dBm			
DSG3000 Output Frequency	Delta	Limit	Pass/Fail	
10 MHz		<-30 dBc		
500 MHz				
1 GHz				
2 GHz				
5 GHz (only DSG3060)				

AM Internal Modulation Test:

DSG3000 Output Frequency	Item	Measurement	Calculation Result	Limit	Pass/Fail
1 GHz	Modulation Accuracy ^[1]			<AM depth setting × 4% + 1%	
	Distortion ^[2]			<3% (typ.)	

Note:

[1] Modulation Accuracy = $|(Pk - Pk)/2 - 30\%|$

[2] AM distortion = Distortion value in the AM analog demodulation test interface

FM Internal Modulation Test:

DSG3000 Output Frequency	Item	Measurement	Calculation Result	Limit	Pass/Fail
1 GHz	Modulation Accuracy ^[1]			<FM deviation setting × 2% + 20 Hz	
	Distortion ^[2]			<2% (typ.)	

Note:

[1] Modulation Accuracy = $|(Pk - Pk)/2 - 50 \text{ kHz}|$

[2] FM distortion = Distortion value in the FM analog demodulation test interface

ØM Internal Modulation Test:

DSG3000 Output Frequency	Item	Measurement	Calculation Result	Limit	Pass/Fail
1 GHz	Modulation Accuracy ^[1]			<ØM deviation setting × 1% + 0.1 rad	
	Distortion ^[2]			<1% (typ.)	

Note:

[1] Modulation Accuracy = $|(Pk - Pk)/2 - 5 \text{ rad}|$

[2] ØM distortion = Distortion value in the ØM analog demodulation test interface

AM External Modulation Test:

DSG3000 Output Frequency	Item	Measure-ment A1	Measure-ment A2	Calculation Result ^[1] (dB)	Limit	Pass/Fail
1 GHz	Frequency Response				<3 dB (nom.)	

Note: [1] Calculation Result = $|20\lg(A2/A1)| \text{ dB}$

FM External Modulation Test:

DSG3000 Output Frequency	Item	Measure -ment A1	Measure -ment A2	Calculation Result ^[1] (dB)	Limit	Pass/Fail
1 GHz	Frequency Response				<3dB (nom.)	

Note: [1] Calculation Result = $|20\lg(A2/A1)|$ dB

ØM External Modulation Test:

DSG3000 Output Frequency	Item	Measure -ment A1	Measure -ment A2	Calculation Result ^[1] (dB)	Limit	Pass/Fail
1 GHz	Frequency Response				<3dB (nom.)	

Note: [1] Calculation Result = $|20\lg(A2/A1)|$ Db

Pulse Modulation Test:

DSG3000 Output Frequency	Item	Measure -ment	Calculation Result ^[1]	Limit	Pass/Fail
1 GHz	On/Off Ratio			>80 dB	
4 GHz (only DSG3060)	On/Off Ratio			>70 dB	

Note: [1] Calculation Result = - Delta.

I/Q Modulation Test:

DSG3000 Output Frequency	Item	Measurement	Limit	Pass/Fail
800 MHz	EVM ^[1]		≤ 0.7 %rms (typ.)	
2.4 GHz			≤ 0.7 %rms (typ.)	
5.8 GHz (only DSG3060)			≤ 1.2 %rms (typ.)	

Note: [1] The parameter is measured at 16QAM, root cosine filter ($\alpha = 0.22$), sample rate 4MSps.