

# G3 GALAXY

## Operators Manual



*The Originator of Electronic Darts*

6212 Material Avenue  
Loves Park, Illinois 61111  
815-654-0212 or 800-435-8319

[www.arachnidinc.com](http://www.arachnidinc.com)  
P/N 43179 Rev. H



## GALAXY 3 PURCHASE AND LICENSE AGREEMENT TERMS AND CONDITIONS

**1. General Provisions.** These terms and conditions (this "Agreement") govern all orders from Arachnid Inc.'s customer ("Buyer") to Arachnid, Inc. ("Arachnid") for, and sales and the grant of related licenses by Arachnid to Buyer of, the Arachnid product referred to as the "GALAXY 3" and its software (the "Product"). With respect to the Products, the terms and conditions of this Agreement shall (i) supersede any conflicting or additional terms contained in any advertisement, quotation, purchase order, confirmation, acknowledgment or other document or communication heretofore or hereafter between Buyer and Arachnid, and (ii) apply whether or not Arachnid or Buyer or both specifically reference this Agreement in any document concerning any order for or sale of the Products, unless Arachnid and Buyer expressly otherwise agree in a writing signed and delivered by each of them to the other which specifically references this Agreement by date and describes which terms and conditions of this Agreement are excepted and superseded. Arachnid's acceptance of any order by Buyer for a Product is expressly conditioned upon the applicability of this Agreement. All orders are subject to Arachnid's approval, including approval of credit terms. EXCEPT TO THE EXTENT LICENSED IN SECTION 2 BELOW, BUYER IS NOT ACQUIRING FROM ARACHNID ANY OWNERSHIP OR OTHER RIGHTS IN AND TO ANY OF THE SOFTWARE OR OTHER INTELLECTUAL PROPERTY USED TO OPERATE, OR COMPRISING ANY PART OF, THE PRODUCTS. Unless otherwise specified by Arachnid, payment is due 30 days from the date of Arachnid's invoice. Shipments shall be F.O.B. Rockford, Illinois, and at the risk of Buyer after delivery to the carrier. Arachnid will make all reasonable efforts to meet any shipment schedule specified in Buyer's purchase orders, but shall not be liable for failure to do so. In addition, Arachnid shall not be liable for any damage to or loss of the Products or any delay in or failure to ship, deliver, service, repair or replace the Products arising from any circumstances beyond Arachnid's control. The Products are sold for installation and interconnection by Buyer or its customers and Arachnid shall have no obligation in connection therewith.

**2. License Provisions.** Subject to the terms and conditions of this Agreement, Arachnid grants Buyer a non-exclusive license (referred to in this Agreement as the "License") to use the operating game software supplied as part of the Products ("Game Software"). Arachnid is either (i) the owner of all rights in and to the Game Software, including, but not limited to, copyrights and trade secret rights, or (ii) a licensee of certain components of the Game Software and is authorized to include such components in the Products. This Agreement does not convey to Buyer ownership of any of the software in the Product and Arachnid or Arachnid's licensors retain all title and ownership in such software and any modifications, updates or enhancements thereof. The Game Software shall only be used on a single Product at one time. Buyer shall not transfer or distribute the Game Software or the License to others, except that Buyer may transfer to only the customer purchasing or using the Product a sublicense for that Product only to use the Game Software embedded in the Product on the terms and conditions set forth herein. Except to the extent provided in the next sentence, neither Buyer nor its customers nor any subsequent transferees shall have any right to copy, reproduce, distribute, transmit, remove, download, decompile, reverse engineer or modify the Game Software, nor the right to remove, obstruct or alter copyright, patent, trademark and software license notices on or accompanying the Product or its Game Software. The owner and licensee of the Product shall have the right to copy for installation into the Product and to install into the Product updated Game Software that may be distributed to such owner and licensee from time to time by Arachnid. Neither the Products nor any of its Game Software shall be exported or re-exported in violation of any export provisions of the United States or any other applicable jurisdiction. Except to the extent expressly permitted under this Section 2, any attempt to sublicense, assign or transfer any of the rights, duties or obligations hereunder is void. In the case of the United States Government or an agency thereof as licensee, the following additional terms and notices apply:

Restricted Computer Software, as defined in the Rights in Data-General clause at Federal Acquisition Regulations 52.227\_14; and as applicable,

### RESTRICTED RIGHTS LEGEND

Use, duplication, or disclosure by the Government is subject to restrictions as set forth in subparagraph (c)(1)(ii) of the Rights in Technical Data and Computer Software clause at DFARS 252.227\_7013.

Arachnid may without notice or demand terminate the right to use the Game Software (or any part thereof) and may also disable use of the Game Software (or any part thereof) if Buyer or its customer or any subsequent transferee or other user of the Product breaches any of the terms and conditions of this Agreement or any other agreement between Arachnid and any other owner/licensee of the Product in question (including without limitation any agreement governing or relating to any of the advertising programs referred to in Section 3 below). Upon termination of this License for any reason, Buyer or its customer or any subsequent transferee shall immediately delete the Game Software from the Product and return to Arachnid any form of the Game Software which is capable of being returned. All restrictions regarding use of and protecting Arachnid's rights in the software in the Product survive termination of Buyer's or any subsequent owner's or user's right to use the Game Software. Arachnid shall at all times while the Products are in use have and be granted access to the Product (whether electronically, including by modem or any other electronic data transmission and reception connector which comprises a part of each Product, or otherwise), at reasonable times and upon reasonable intervals, for the purposes of inspecting the Product, collecting usage information (including without limitation its location) and exercising and protecting Arachnid's rights in connection with the provisions set forth in this Section 2. Buyer shall not, and shall not permit any subsequent owner or user to, obscure, attach or remove any notice, informational plate or sticker affixed by Arachnid to the Product or which Arachnid creates to appear on any screen display of the Product. Buyer shall cause its customers and all subsequent transferees (if any) to be bound by the provisions of this Section 2 and Sections 3, 4 and 5 of this Agreement for the benefit of Arachnid (Arachnid shall be a third party beneficiary with the right of enforcement).

**3. Future Advertising.** Neither Buyer nor any other person or entity is as a result of Buyer's purchase of the Product acquiring any license or other rights in and to the software (if any) in the Product which enables or may enable the Product to display advertising. Arachnid may (but is not hereby obligated to do so) enter into arrangements with the owner/ licensee of a Product pursuant to which the Product may display advertisements; provided, that in the event any such arrangements are made, then (i) any such license to use the software in the Product for any purpose other than game operation shall be terminable at will by Arachnid and Sections 2, 4, 5 and 6 of this Agreement shall apply with respect to that license (and for such purpose, the phrase "Game Software" as used in this Agreement shall also refer to the software of the Product to the extent used in connection with advertising displayed by the Product), and (ii) Arachnid shall not be liable to Buyer for, and Buyer shall indemnify and hold Arachnid harmless against and shall upon request defend Arachnid against, any claims, losses, damages, costs or expenses arising out of or in connection with any such advertising, including without limitation claims for infringement of copyright, tradename, trademark or service mark, and defamation claims.

**4. Warranty.** Subject to the terms and conditions of this Section 4, for the applicable Warranty Period (as hereinafter defined), Arachnid will repair or replace at its plant in Rockford, Illinois, any of the following parts of the Product which Arachnid determines is defective in manufacture or workmanship under normal use and service: the Electronic Package; the darthead assembly (consisting of the spider, segments and matrix); and the cabinet and components of the cabinet. "Electronic Package" means only (i)

the power supply chassis and the parts mounted directly thereon, (ii) the main computer printed circuit board, (iii) to the extent installed by Arachnid, the modem (if any), and the light dimmer board. The "Warranty Period" starts on the date of delivery and means (i) 90 days with respect to the Electronic Package, (ii) 9 months for the monitor, (iii) one year with respect to the darthead assembly, and (iv) 30 days with respect to the cabinet and cabinet components. The Product will not be defective if it substantially fulfills the performance specifications. This warranty shall not apply to any of the Products or parts thereof repaired or altered by anyone but Arachnid, operated or installed contrary to instructions or contrary to this Agreement, or subjected to abuse, misuse, accident or improper environment. This warranty applies only for the benefit of the original purchaser of the Product and is not transferable. For this warranty to apply, Buyer must (i) give Arachnid written notice of any warranted defect within 10 days after discovery and, in any event, not later than the date on which this warranty expires, and (ii) deliver the Product into Arachnid's possession within 15 days following the date on which the warranty claim notice is given to Arachnid. Any Product which is the subject of a warranty claim must be shipped to Arachnid freight prepaid. Prior to repair or replacement, Arachnid shall have the right to examine the part at Arachnid's plant in Rockford, Illinois. If Arachnid determines that this warranty is inapplicable, Arachnid will notify Buyer, and labor and parts furnished at Buyer's request shall be paid for by Buyer at Arachnid's then current rates and prices. Arachnid neither assumes nor authorizes anyone to assume for it any obligation or liability in connection with the Product which is not expressly provided for under this Agreement. Arachnid's liability under this warranty shall be limited to repairing or replacing warranted Products and the expense of the lowest transportation costs for return to Buyer or, if the Product in question cannot be repaired or replaced by Arachnid, to the return of the purchase price paid for the defective or nonconforming warranted Product in question; provided, that Buyer shall first return to Arachnid, and Arachnid shall have the right to thereafter retain as its own property, those Products for which a refund of the purchase price is to be made. Notwithstanding anything to the contrary in this Section 4, Arachnid does not warrant that the operation of the Game Software will be uninterrupted or error-free. **THE WARRANTY SET OUT IN THIS SECTION 4 IS THE ONLY WARRANTY APPLICABLE TO THE ORDER OR THE PRODUCTS. ALL OTHER WARRANTIES, EXPRESS OR IMPLIED, INCLUDING BUT NOT LIMITED TO THE IMPLIED WARRANTIES OF MERCHANTABILITY AND FITNESS FOR A PARTICULAR PURPOSE, ARE DISCLAIMED.**

**5. Limitation of Liability. NEITHER ARACHNID NOR ITS DEALER OR REPRESENTATIVE, IF ANY, SHALL BE LIABLE, WHETHER IN CONTRACT, IN TORT, UNDER ANY WARRANTY, IN NEGLIGENCE, OR OTHERWISE, FOR INCIDENTAL, CONSEQUENTIAL, SPECIAL OR PURELY PECUNIARY DAMAGES OR FOR LOSS OF DATA OR FOR COSTS OF REMOVAL OR SHIPMENT. UNDER NO CIRCUMSTANCES SHALL ARACHNID'S LIABILITY OR BUYER'S REMEDY FOR DAMAGES AGAINST ARACHNID EXCEED THE AMOUNT OF THE PURCHASE PRICE OF THE PRODUCTS WITH RESPECT TO WHICH CLAIM IS MADE. IN THE EVENT THAT ARACHNID'S WARRANTY, IF ANY, OR ANY OTHER OBLIGATION OF ARACHNID APPLICABLE TO THE PRODUCTS FAILS OF ITS ESSENTIAL PURPOSE, BUYER'S EXCLUSIVE REMEDY SHALL BE LIMITED TO RETURN OF OR CREDIT FOR SO MUCH OF THE PURCHASE PRICE AS IS APPLICABLE TO THE PRODUCTS WHICH ARE NONCONFORMING OR DEFECTIVE, PROVIDED SUCH PRODUCTS ARE RETURNED TO ARACHNID F.O.B. ARACHNID'S PLANT IN ROCKFORD, ILLINOIS, U.S.A. NO ACTION ARISING OUT OF THE ORDER OR PERTAINING TO THE PRODUCTS IN QUESTION MAY BE BROUGHT BY BUYER MORE THAN ONE YEAR AFTER THE DATE OF SHIPMENT, OR, IN THE CASE OF WARRANTY CLAIMS, WITHIN ONE YEAR AFTER THE CLAIM WAS OR SHOULD HAVE BEEN DISCOVERED, BUT IN NO EVENT MORE THAN TWO YEARS AFTER SHIPMENT. BUYER'S REMEDIES PROVIDED IN THIS AGREEMENT ARE ITS SOLE AND EXCLUSIVE REMEDIES.**

**6. Other Provisions.** Upon Buyer's failure to pay or otherwise perform in accordance with this Agreement or any order governed by this Agreement, all amounts owing to Arachnid by Buyer under the order in question and any other order or obligation of Buyer to Arachnid shall, at Arachnid's option and without notice, become immediately due and payable. Any payment not received by Arachnid on its due date shall be subject to a late charge of 1.5% per month until paid, unless applicable law limits this charge, in which event, the applicable late charge shall be the maximum monthly charge permitted by applicable law. Buyer shall pay Arachnid all attorneys' and paralegal fees and all court costs and out-of-pocket disbursements incurred by Arachnid to effect collection. Arachnid's rights and Buyer's obligations under Sections 2, 3, 4, 5 and this Section 6 of this Agreement shall survive any termination of this Agreement. This Agreement is made in and it and all matters pertaining to the Products shall be governed by the internal laws (without reference to the conflicts of laws principles thereof) of the State of Illinois. The invalidity of any term contained in this Agreement shall not affect any other of the terms of this Agreement. The failure of any party to enforce or declare a default or breach with respect to any particular term or condition of this Agreement or any purchase order governed by this Agreement shall not be considered a waiver of that party's right to enforce or declare a default or breach with respect to any other term or condition or, on a subsequent occasion, with respect to that particular term or condition. Galaxy 3 v1 --12/3/01



# Table of Contents

<b>Introduction</b>	<b>1</b>
<b>Section 1: General Description</b>	<b>1</b>
<b>1.1 Dimensions</b>	<b>1</b>
<b>Section 2: Features of the Machine</b>	<b>1</b>
<b>Section 3: Galaxy 3 Basics</b>	<b>2</b>
<b>3.1 Assembly</b>	<b>2</b>
<b>3.2 Basic Terms</b>	<b>3</b>
<b>3.3 Standby Switch and Reset Button</b>	<b>3</b>
<b>3.4 Motherboard Ports</b>	<b>3</b>
<b>3.5 IOB Basics</b>	<b>3</b>
<b>3.6 Target Interface Board</b>	<b>4</b>
<b>3.7 Switching from a 15" Darthead to a 13" Darthead</b>	<b>5</b>
<b>3.8 Remote Play</b>	<b>6</b>
<b>3.9 Mainboard Color Code Diagram</b>	<b>8</b>
<b>Section 4: Operation</b>	<b>9</b>
<b>4.1 Power Up</b>	<b>9</b>
<b>4.2 Game Play</b>	<b>9</b>
<b>4.3 Service Mode</b>	<b>11</b>
<b>Section 5: Technical Description</b>	<b>16</b>
<b>5.1 Monitor</b>	<b>16</b>
<b>5.2 Power Supply</b>	<b>16</b>
<b>5.3 Hardware</b>	<b>16</b>
<b>5.4 Operating Conditions at 120VAC</b>	<b>16</b>
<b>5.5 Darthead</b>	<b>16</b>
<b>5.6 Target Interface Board</b>	<b>16</b>
<b>5.7 Missed Dart Detector</b>	<b>16</b>
<b>Section 6: Internet Communications</b>	<b>15</b>
<b>6.1 LeagueLeader Setup</b>	<b>15</b>
<b>6.2 Setting up a Wired Network</b>	<b>15</b>
<b>6.3 Setting up a Wireless Network</b>	<b>15</b>
<b>6.4 Setting up a Dialup Modem</b>	<b>16</b>
<b>Section 7: Network Communication</b>	<b>16</b>
<b>7.1 Connecting to a Galaxy II/Galaxy II.5</b>	<b>16</b>
<b>7.2 Other Methods of Connecting Multiple Galaxy 3's</b>	<b>17</b>
<b>Section 8: Maintenance</b>	<b>17</b>

**The most current version is always available on the Arachnid website at:**

**<http://www.arachnidinc.com>**

Note: This equipment has been tested and found to comply with the limits for a Class A digital device, pursuant to part 15 of the FCC Rules. These limits are designed to provide reasonable protection against harmful interference when the equipment is operated in a commercial environment. This equipment generates, uses, and can radiate radio frequency energy and, if not installed and used in accordance with the instruction manual, may cause harmful interference to radio communications. Operation of this equipment in a residential area is likely to cause harmful interference in which case the user will be required to correct the interference at his own expense.

Covered by one or more of the following U.S. and/or foreign patents.

140531, 5020806, 5197094, 5359510, 5401033, 5496039, 0477320, P69120886.7, 5114155, 5318319, D328726, 5355302, 5848398, 6397189, 6279912, D414521, D423597, D448809, D468368, 214662, 2815483, ZL01302307.1, 40103986.2, 151194, 6076021, 5743533, 5681044, 5482291, 4955967, 4881744, 6805354, 6974133,

**Caution: Never place the Galaxy 3 in high traffic areas. Although Arachnid boards use safety darts, they still do hurt when thrown at people. Take care that no accidents happen.**

# Introduction

This manual contains assembly, operation and troubleshooting information for Arachnid's Galaxy 3 dart machine.

If you encounter a problem that is not covered in this manual, or if you have any questions, contact Arachnid at 800-435-8319 from 8 a.m. to 5 p.m. CST.

## Section 1 General Description

The dart machine is a coin operated unit offering players a wide variety of game choices to challenge all skill levels.

### 1.1 Dimensions

**Weight Boxed:** 160 LBS

**Weight Unboxed:** 130 LBS

**Boxed Dimensions:** 40x30x45

**Game Height:** 83-1/2"

**Game Width:** 27"

**Game Depth:** 18-1/2"

For details on the electrical systems see Chapter 5 **Technical Description.**

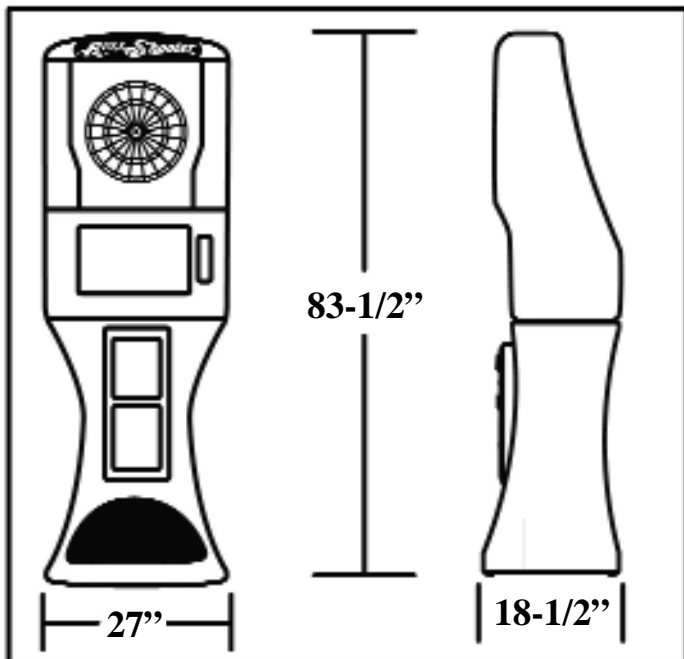

## Section 2 Features of the Machine

This section lists the features and games available on the machine.

### A. All the Familiar Features of the Galaxy 2

All the features you liked about the Galaxy II have been carried over to the Galaxy 3.

- ♦Happy Hour times and Pricing
- ♦Automatic Player Change
- ♦Casual Mode Player Stats
- ♦Adjustable Hours of Operation
- ♦Missed Dart Detector
- ♦Color Flat Screen Monitor

### B. Brand New Player Feats and Graphics

New dartboard means new Graphics! All of the feats and game screens have had a major overhaul.

### C. Adjustable Darthead

The game comes with the traditional 15" darthead and the European 13" darthead. Both of which are mounted on a rotating back board. Flip the latch and switch Dartheads. Easy!

### D. LED Target Illumination and Marquee

Along with the new target comes new ways to light the dartboard. Strips of LED lights line the side of the cabinet giving the player a clear and well lit darthead to throw at. These same LED's can be configured to display patterns of color to attract players to the game.

### E. Internet Communications

The Galaxy 3 can communicate with the Internet via Ethernet Cable or WiFi. No more phone lines!

### F. League Play!

That's right! Paperless Leagues! We are the leader of league play and intend to stay that way.

### G. Remote Play!

The Galaxy 3 is capable of playing across the internet. This means someone in your bar can play against someone in another country!

## Section 3 Galaxy 3 Basics

This section instructs you how to assemble your Galaxy 3 once it is unpacked. This section also explains some basic terms and explains the layout of several important areas of the Galaxy 3.

### 3.1 Assembly

1. Insert the four set screws provided into the top of the lower cabinet.
2. Place the upper cabinet assembly on the lower cabinet.
3. Unlock the bezel.
4. Flip down the monitor and monitor bezel.
5. Secure the upper cabinet to the lower cabinet using the four wing nuts provided.
6. Feed the wiring harness and connector through the hole in the lower cabinet to the upper cabinet and connect to the IOB.

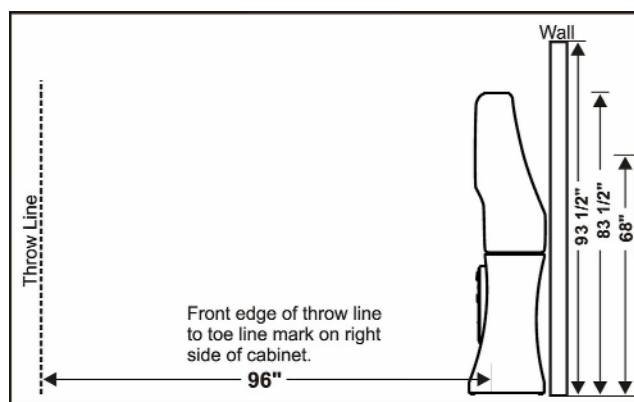

7. Insert the eye bolt into the hole provided on the back of the Galaxy 3.
8. Secure the eye bolt to the back of the machine with a washer on the inside and outside and nut provided.
9. Locate a wooden wall stud behind the Galaxy 3. We are going to use that to anchor the Galaxy 3 to the wall. The drywall can be up to 5/8" thick in front of the wall stud
10. Measure up from the floor 44" and mark the spot on the wall.
11. Drill 2-1/2" pilot hole with a 3/32" bit.
12. Slide a washer up to the eyelet of the 3/16 x 2-3/16" Eye Lag Screw.
13. Secure the Eye Lag Screw and washer to the wall stud.
14. Connect the two Eye bolts together with the chain provided.

15. Close and secure the monitor and monitor bezel.



**IMPORTANT:** The Galaxy 3 should not be operated until it is placed with its back against a wall in an area where bystanders will not get struck by a dart.

### 3.2 Basic Terms

**Marquee** - The Marquee is designed to catch the eye of the players and entice them into playing the game.

**Darthead** - The target at which players throw their darts at the Galaxy 3 has a 15" darthead and a 13" darthead.

**Catch Screen** - The part around the target that catches any missed darts.

**Target Illumination Panels** - These LED panels illuminate the target in clear white light. They are also used in attract mode to catch the players eye.

**Navigation Buttons** - Use the Up, Down and Enter buttons to navigate the menus of the Galaxy 3.

**Monitor** - A 19" widescreen HD Monitor.

**Coin Door** - This is where the Coin Mechanisms and Dollar Bill Acceptors are installed.

**Darthead Latch** - Use this to unlock the darthead and flip it to the other side.

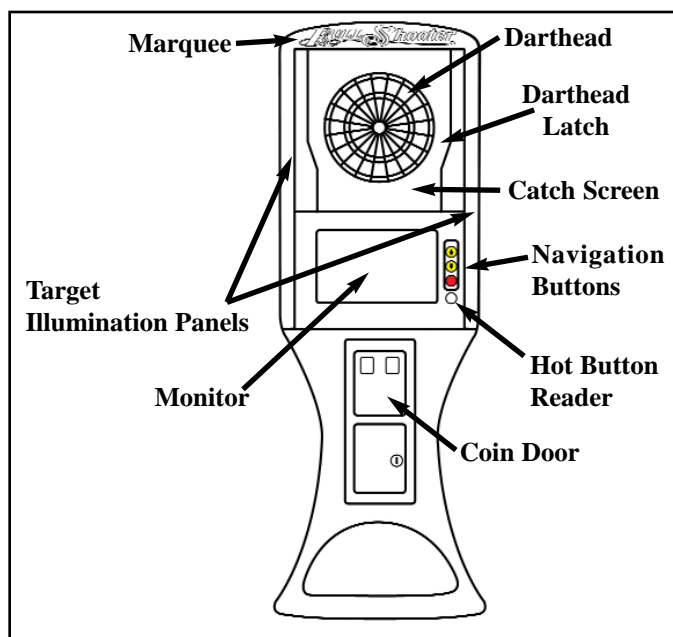



### 3.3 Standby Switch and Reset Button

This section describes the functions of the Standby switch.

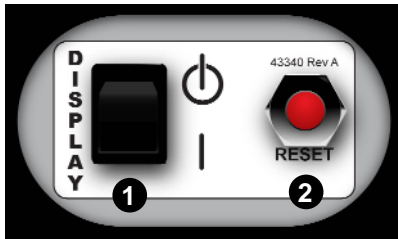

1. **Standby Switch** - This switch controls Monitor and Target Illumination Panels. Toggle this switch to put the Galaxy 3 in standby mode. This will leave the main board on but everything else will be turned off.
2. **Reset Button** - Restores power to the game if AC power is lost.

### 3.4 Power Inlet and Fuse



1. **Power Inlet** - Is where the power plugs in to the machine.
2. **Fuse** - Is a 3.5A Slo-Blo.

### 3.4 Mother Board Ports

This section describes the functions of the various ports on the back of the game as well as the function for the Standby switch.

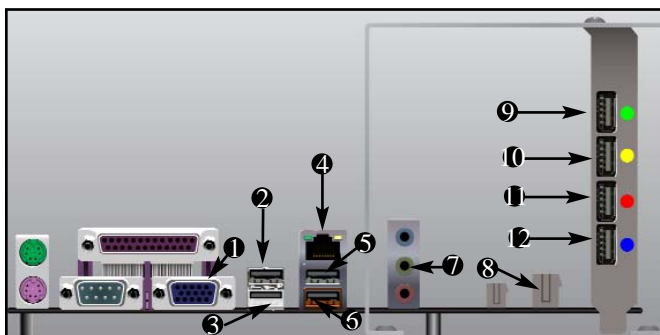

*Caution: The Target Camera, Play Camera, Left LED, Right LED and the Marquee will not function if they are not plugged into the correct ports. (See Mother Board Color Code Diagram on page 7.)*

1. This is the VGA port that your monitor is plugged into.
2. The IOB is plugged into this port and controls various functions like the navigation buttons and coin switches.

3. Controls camera pointed towards the player.
4. Used to set up a wired network with a router. It is already plugged into its counterpart on the back of the machine.
5. This port is used to update machine information, leagues, and software.
6. Controls camera pointed towards the target.
8. Use this PCI slot to plug in a modem or a WiFi card.
7. Controls the speakers.
9. Controls the Marquee on the top of the machine.
10. Controls the left Target Illumination Panel.
11. Controls the right Target Illumination Panel.
12. This port controls the Target Interface Board. All signals coming from the darthead flow into this port.

### 3.5 IOB Basics

This section describes the basic layout of the IOB. The IOB or Input/Output board controls the various external devices in the dartboard such as the Target Interface Board, the target LED's and the Marquee.

1. Plug for the Coin Door Wire Harness
2. Plug for the Main Wire Harness.

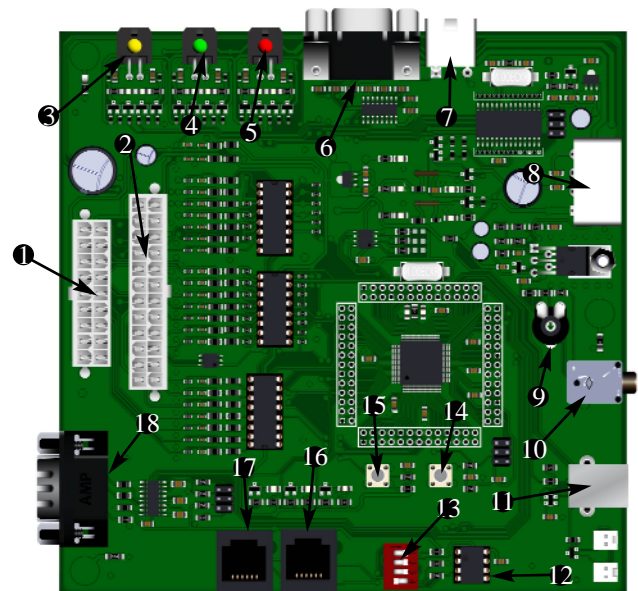

3. Plug for the Left Target Illumination Panel.
4. Plug for the Marquee on the top of the machine
5. Plug for the Right Target Illumination Panel.



6. Parallel port that connects to the motherboard. This controls the lights.
7. Connector for the “Stand By” button on the back of the machine.
8. This is the power connector for the IOB.
9. This is the manual volume control.
10. This is the audio jack for the Galaxy 3.
11. This USB B-Type port is used to connect the IOB to the motherboard (see Section 3.4).
12. Network Chip. This is for controlling the Legacy Arachnet (see Sections 7.1 and 7.2).
13. The Dip Switches are used when setting up a Legacy Arachnet (see Sections 7.1 and 7.2).
14. The Reset Button will reset the IOB.
15. The Service Button will bring you into the Service Mode (see section 4.3).
16. The Comm In port used when setting up a Legacy Arachnet (see Sections 7.1 and 7.2).
17. The Comm Out port is used when setting up a Legacy Arachnet (see Sections 7.1 and 7.2).
18. Additional Bill Acceptor communications port (not currently used).

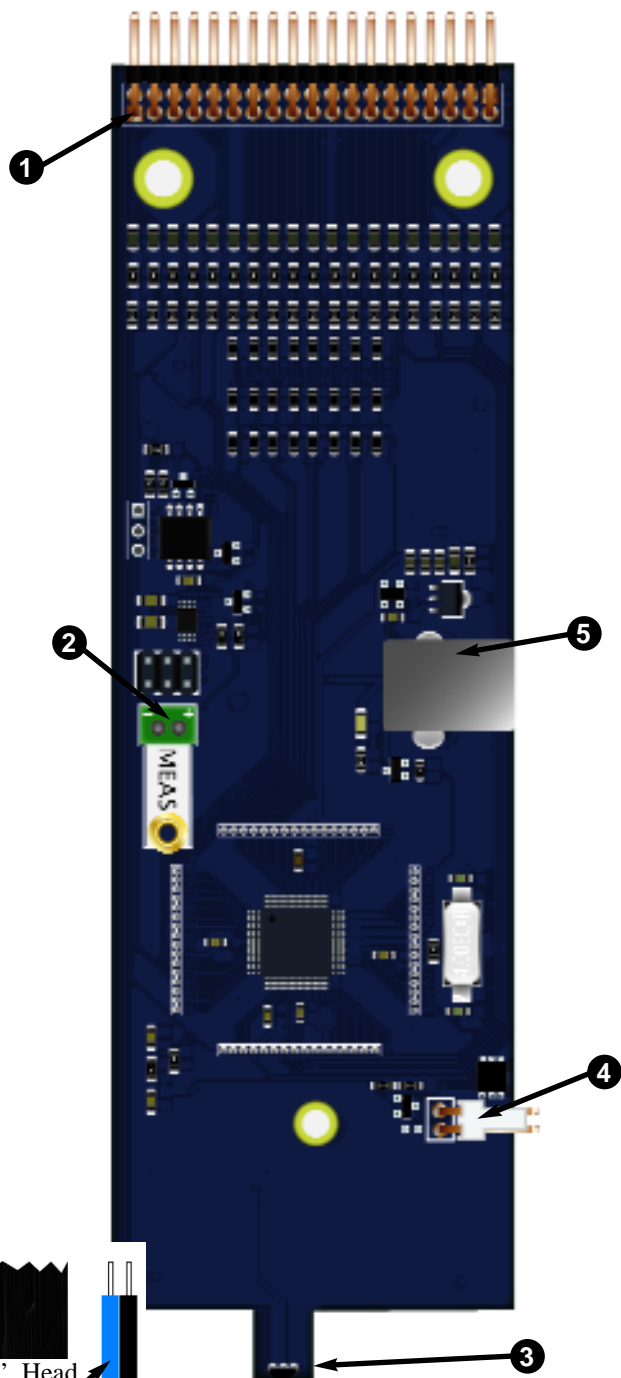

### 3.6 Target Interface Board Basics

The Target Interface Board (TI Board) controls the sensors for the darthead as well as the Missed Dart Detector (MDD). It also tells the IOB which darthead is currently being used.

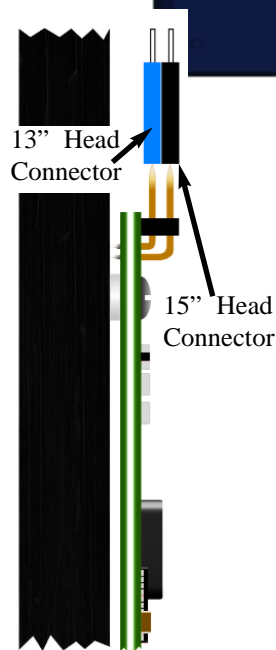
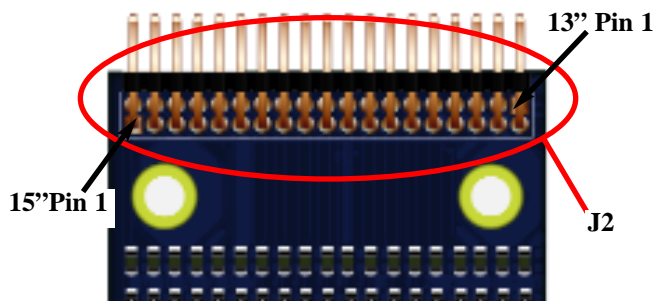

TI Board Side View

1. The connector, designated J2, is where the two Darthead Switch Matrix Membranes are plugged into the Target Interface Board.

The 13” Matrix Membrane is plugged into the bottom row while the 15” is plugged into the top row.

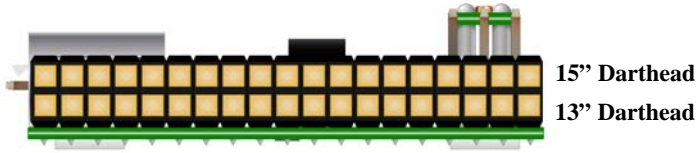

TI Board Top View

When connecting up the Switch Matrix Membranes to the TI Board, make sure the 13" darthead is plugged in to the bottom pins on the J2 connector and the 15" darthead is plugged into the top pins of the J2 connector.

2. The Missed Dart Detector senses if a dart misses the darthead.
3. The technical term is Hall Effect Sensor. Basically it senses magnetic fields. This little transducer senses when the door is flipped to the other darthead.
4. This two pin connector is used for the Door latch Sensor. With this in place, the board won't cause a missed dart to go off when changing between the 15" darthead and the 13" darthead.
5. This USB port connects to the USB card on the motherboard.

### Adjusting the Missed Dart Sensitivity

The new Target Interface board doesn't have an adjustment pot on it. The sensitivity can be adjusted in the Galaxy 3 Service Mode under Machine Setup → More Machine Setup → Target/Missed Dart Detector setup.

From there you can disable the Missed Dart Detector all together or **Adjust Missed Dart Detector Sensitivity**.

### 3.7 Switching from a 15" Darthead to a 13" Darthead and Back

The Galaxy 3 is unique in that it has both a 15" and 13" darthead on the same game. Why two dartheads? Why not? The idea was to give you one more choice in playing darts.

The 15" darthead is common in the United States but the 13" is more common in European nations. The 13" is a smaller head so it tends to make the game more challenging.

*Note: When flipping dartheads you **DO NOT** need to turn off the game.*

Push the Darthead Latch toward the darthead and push on the catch screen near the latch.

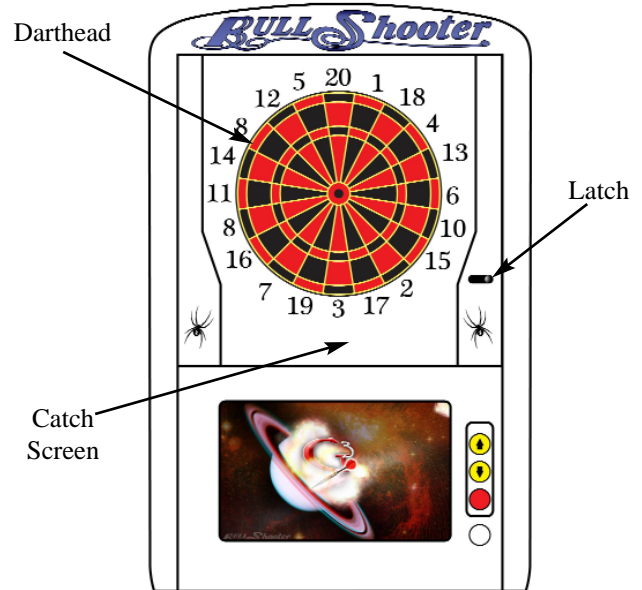

15" Darthead Face

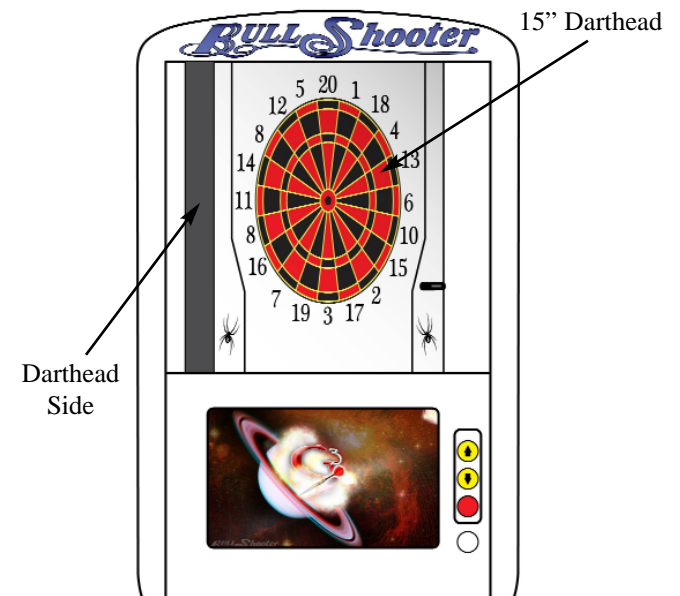

15" Darthead Pushed Forward

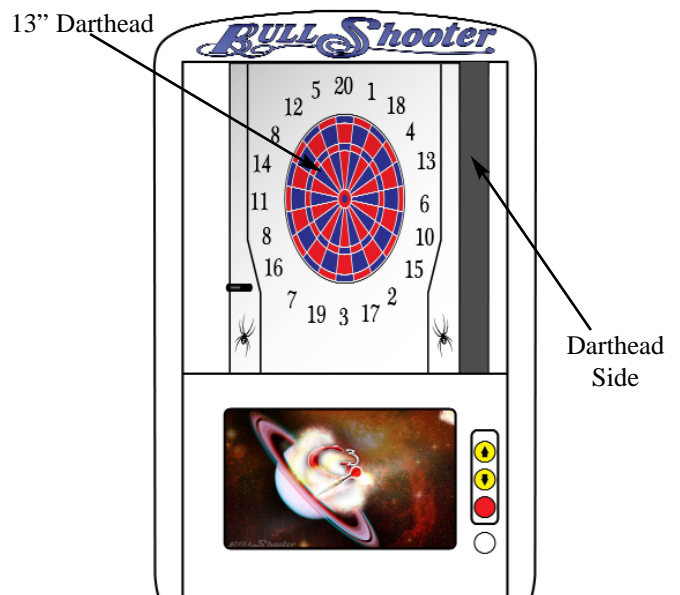

Pushing the 13" Darthead Forward  
Galaxy 3 Operating Manual

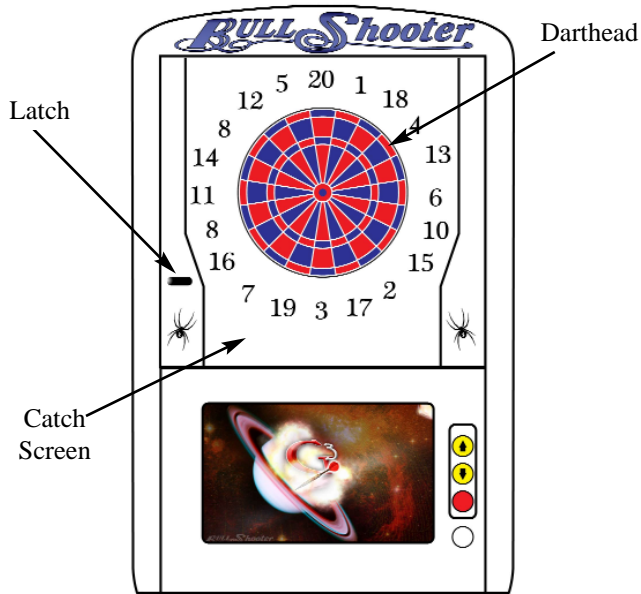

**13" Darthead Face**

By pushing the darthead back into place, the latch will automatically lock into place.

It is perfectly safe to switch dartheads while power is on. It is even possible to switch dartheads in the middle of a game. We did this as a way of adding an extra handicapping element to the game.

Example: Ken is a very bad dart player. His points per dart is around 10.0 or maybe less. Bill on the other hand is a fair shot but doesn't like the casual mode handicapping system. They decide to use the Galaxy 3's darthead as a handicapping system. Ken will throw on the 15" darthead while Bill will throw on the 13" darthead.

*Note: This feature is only available in casual mode and not Remote Play or League Play.*

### 3.8 Remote Play

Remote play allows players to play from their home bar against other players or teams over the internet. The two players can be on opposite sides of the Earth and still play against each other.

The Galaxy 3 has a camera in the upper left hand side of the top cabinet (as you are looking at it) and a camera hidden in the marquee.

The upper left hand camera is angled toward to the dart face so that the other player can see every dart hit.

The camera in the marquee is pointed toward the player.

An operator needs to have an active LeagueLeader account for this to work and the Galaxy 3 needs to be configured properly with LeagueLeader (see Section 6.1 for board side setup).

In LeagueLeader, you can decide whether to give a location an **Age Restriction**. Only locations that have **Age Restriction** activated can see each other. Use this for child friendly locations.

### A. Setting up Remote Play in LeagueLeader

As was stated above, the Remote Play option needs to be turned on in LeagueLeader. If you are unable to get Remote Play to work, try looking in LeagueLeader to make sure that the Galaxy 3 is properly configured and the Remote Play option is turned on.

1. Click on Master.
2. Under the Locations column, select Modify.
3. Choose the location that you want to have Remote Play at.
4. Click on the Galaxy 3.
  - ♦ If there are no Galaxy 3's at this location, add them in. (See the LeagueLeader Manual).
  - ♦ If this location has multiple Galaxy 3's you will need to activate the option on all of them.



5. Click on the check box next to **Remote Play**.
6. Click **OK** when finished.

### B LeagueLeader Setup On the Galaxy 3

LeagueLeader needs to communicate properly with the Galaxy 3 before you can use remote play.

*Note: You can set up the **Connections Method** from this menu or by going into their respective menus.*

1. Go into the setup mode by pressing the Service Button on the IOB.
2. Select **Communications**.
3. Select **LeagueLeader Setup**.
4. Choose the **Communications Method**. You have three choices: Ethernet, WiFi, or Modem (Internet). Each **Communications Method** will have different settings. You can set them up now by going into their respective settings menu right below Communications Method.
5. Enter in your **LeagueLeader Account Settings**. Here you will enter in your FTP Username and Password.

6. Once all settings are entered, including the Device Settings, click on **Perform Update** to test the connection.

### C. Intermediary Server vs. Full Access

Full Access used to be necessary for Remote Leagues to function properly. This is no longer the case. We have added an Intermediary Server which, when Active and Available, removes the need for Full Access.

#### Using the Intermediary Server (Recommended)

The only things required here are that your LeagueLeader account settings are in the machine and you have the IP Setting set to Auto (DHCP).

Set Port Forwarding (Remote Play) to None and change the Port Number to an unused port (e.g., 2510).

#### Enabling Full Access (No Longer Required)

Full Access requires you to add specific settings to the router the Galaxy 3 is attached to. This step requires the locations router to be manually configured by a laptop.

The setup for Full Access is just like Partial Access with a few exceptions:

1. Set the IP Setting to Manual (Static). You will have to create an IP address for the machine and fill in all of the internet settings manually.
2. You will need to set a static port under Port Forwarding (Remote Play). Each Machine at the location will need their own port (e.g., 2500 to 2500, 2501 to 2501, etc.,).
3. You will also need to go into the router for the location and set up port forwarding there as well. This means:
  - a) You will need a laptop to plug directly into the router.
  - b) You will need to set up a single port forward for each machine in the router.

If there are multiple routers, you will need to set up a Port Forward for each router in the network. We have no instructions on setting up your routers because each situation is different.

The website, <http://www.portforward.com/> is a great tool for setting up Port Forwards on a router.

### D. Using Remote Play

Players can access Remote Play directly from the main menu. From here they can access or challenge other online players.

*Note: Remember this option needs to be turned on in LeagueLeader. If not the player won't even be able to access this menu.*

1. Select **Remote Play**.

2. Choose one (1) or two (2) players. These are the players that will be playing the online game in the same bar.
3. The Galaxy 3 will then give you the option to change your name. Default names are Player 1 and Player 2.
  - ♦Select **Change Name**.
  - ♦Follow the instructions on the screen and use the darthead to enter in a name.

*Note: You can use your Player HotButton to enter your name as well.*

4. Press **Continue**. This will take the player to the **Choose A Game** menu. From here you can see:
  - ♦**Games in Progress**- This shows the number of Remote Games that are currently in progress. You can not join these games.
  - ♦**Waiting for Opponent**-This shows you the number of players that have selected that game and are waiting for people to play against.
  - ♦**Waiting to Choose a Game**-This is the number of people in the Choose A Gamer screen (the screen the player is currently in.)
5. Choose a game to play. There will be a list of Locations that have players waiting to play.
7. Select a Location and opponent. This will send a "Challenge" to that location.
  - ♦While in this screen, you may be challenged yourself. You may choose to ignore the challenge or accept it and play against that bar instead.
8. Pay the game cost and play the game.

## 3.9 Top Gun Challenge

Top Gun Challenge is a competitive dart ladder which displays the top ten (10) players in an attract screen. Players choose the match they want to play. They then enter their name into the ladder and they can challenge any one of the three players above their name.

*Note: Both players must be present to play.*

There are several ladders to choose from:

- ♦**301 Open In/Open Out**
- ♦**301 Double In/Double Out**
- ♦**Cricket/200**
- ♦**Chicago Style**
  - 301 Open In/Open Out**
  - Cricket/200**
  - 501 Open In/Open Out**

Every ladder is set to Best 2 out of 3 by default. This setting can be changed in the Galaxy 3 software under machine Setup.

Players need to continue to play Top Gun Challenge to stay on the list. By default, a player gets kicked off the list after 14 days. This is also adjustable by the operator.

### 3.10 Motherboard Color Code Diagram

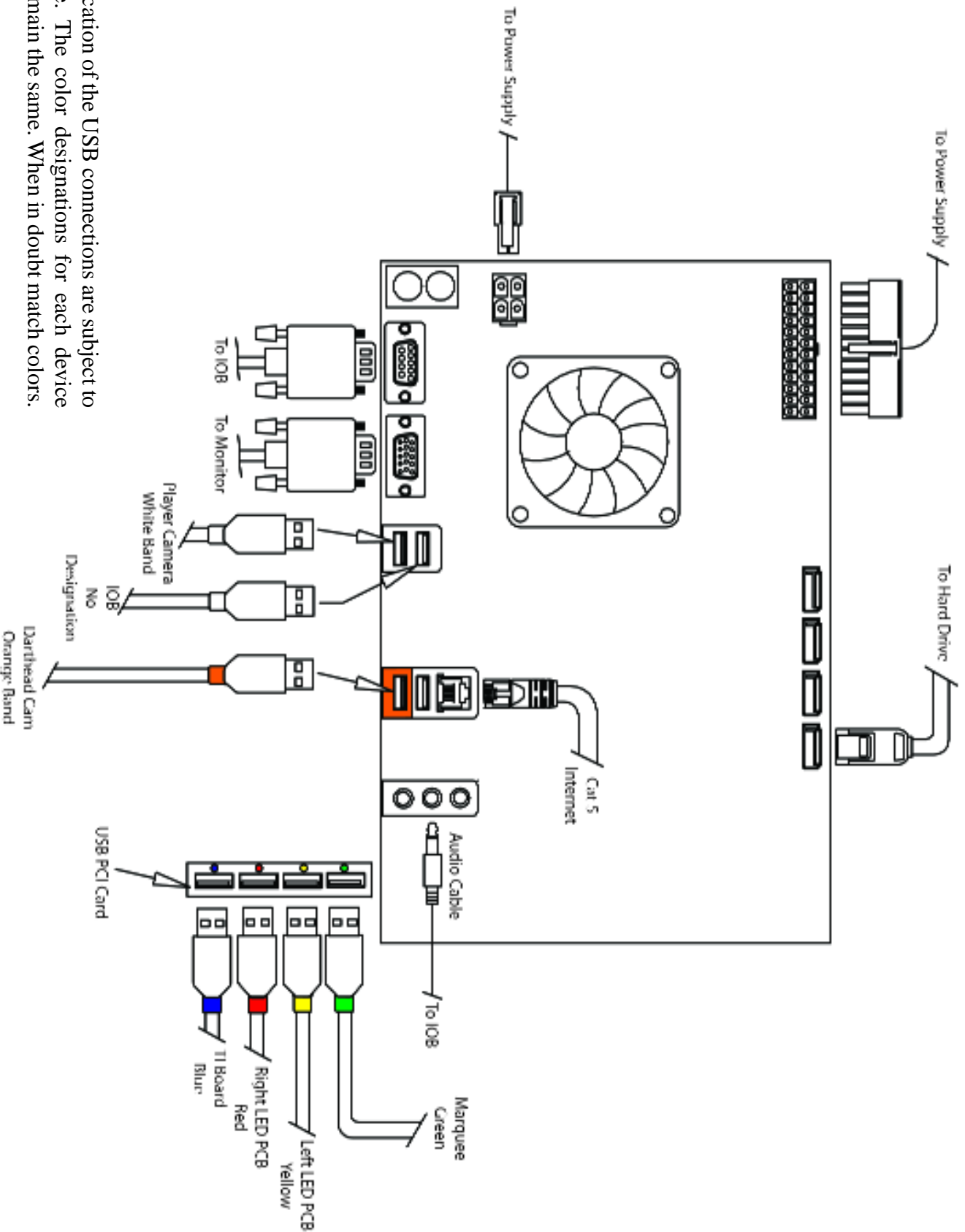

The location of the USB connections are subject to change. The color designations for each device will remain the same. When in doubt match colors.

# Section 4 Operation

## 4.1 Power Up

Once the machine is assembled and set in place, connect the power cord to a wall outlet. **Note: The outlet must have an earth ground and be wired for the correct polarity.** The monitor and target lights are controlled by the switch on the back of the machine.

## 4.2 Game Play

Upon power-up, the machine is ready for play. Players select their game and options using the on screen menus.

### A. 01 Games

The 01 family of games are count-down games for 1 to 8 players. Each player starts with 301, 501, 701, 901, 1101 or 1501 points, depending on the game chosen. The first player to reach exactly zero, or the lowest score when the round limit is reached is declared the winner.

The 01 games are available with the following opening round options:

**Open In:** A hit on any numbered segment will begin the count-down process.

**Double In:** The player must hit any double or the bullseye to begin the count-down process.

**Master In:** The player must hit any double, triple or the bullseye to begin the count-down process.

The 01 games are available with the following final round options:

**Open Out:** Any segment that will bring the players score to exactly zero can be used to “take the game out.”

**Double Out:** Any double that will bring the player to exactly zero must be used to “take the game out.”

**Master Out:** Any double, triple or the bullseye that will bring the players score to exactly zero must be used to “take the game out.”

*Note: Under the 501 menu there is 501 Open In/Open Out Quickie and 501 Open In/Master Out Quickie. These games play the same as a normal 501 game with the same round options. The only difference is they have a round limit of 10.*

### B. Cricket Games

Cricket Games are all based off the traditional steel tip game of the same name. In most cases, the games in this family use numbers 15 through 20 and the bullseye. Read the descriptions to learn how each game is played.

#### Cricket/200

1 to 8 players

Cricket is a game of skill and strategy played with the numbers 15 through 20 and the bullseye. A player must “mark” each number three times before that number is “closed.” A single counts one mark, a double two, and a triple three. Points are scored every time a player hits a number he has closed. Once all players have a number closed, no one can score points on that number. The first player to close all the numbers and the bullseye and have equal to or more points than all his opponents is declared the winner.

Maximum points scored by players may be governed by a preset spread limit in some games. Spread limits control the point spread between players in an effort to keep the better player from running up the score and over-extending the game. For example: If player “A” has 89 points, then player “B” cannot score more than 289 points under a 200 point spread limit. When a player reaches the spread limit, he is forced to try and close another number, as no further scoring is possible until the other player(s) add points to their score. Spread limits can be toggled off or on in the test/setup mode.

#### Double Down Cricket

1 to 4 players

In this game, the object is to be the first to “Double In”, close all your Cricket numbers, and then “Double Down” for the win by hitting the Double 1. There is no scoring in this game and no Bullseyes. The first one to complete the challenge, Wins!

To start, you must hit 2 randomly selected doubles ranging from 2-14. Once “Doubled In”, be the first to close all the Cricket (15-20). After you have closed your Cricket numbers, you will need to hit the Double 1 to win! Any segment other than the Double 1 results in a “Bust”.

#### Hammer Cricket

2 to 4 players

Hammer Cricket is a count-up game using a different Cricket number each round. There are two “Wild” rounds that display a random number between 12-20 or the Bull. Each round, the first dart scored is worth the segment hit, the second is worth two times the segment scored, and the third dart is worth three times the segment scored. If you miss all three darts the hammer falls and reduces your



score by a triple of the segment for that round! During the final round the second and third darts are worth 3 and 5 times the number scored! In the event of a tie game there will be a final tie breaker round. If scores are still tied, the highest MPR wins the game. Hammer Cricket can be configured Masters (Triples only), or Open (Singles, Doubles or Triples).

**Team Hammer** 4 players

Team Hammer plays like Hammer Cricket with one major difference, four players compete as two separate teams. Each player tries to get as many points as possible. Points from both team members are added together into one score. When a player misses all three darts, his score and that of his team is reduced by a triple of the segment for that round! Team Hammer can be configured as Masters (Triples only), or Open (Singles, Doubles or Triples).

**Cut-Throat Cricket** 2 to 8 players

The object is to close all the numbers and have the lowest score. Once a player closes a number, additional marks will score points for opponents who have not closed that number. There is no point spread limit for this game.

**Team Cricket** 4 players

Team Cricket has two different sets of rules that can be used to play. To turn on the New Team Cricket rules, you will need to configure that option in the Setup Mode (see page 6 of this manual).

Both sets of rules are played with four players playing as two teams. Each player marks individually; however, team partners score together as a team. Both partners must have a number closed before either can score on that number.

In the **Traditional Rules**, to win, both teammates must have all the numbers and the bullseye closed and the team must have equal to or more points than their opponents.

In the **New Rules**, to win, a team needs only one player to have all the numbers and the bullseye closed. They still must have equal to or more points than their opponents.

A 400 point spread limit is the default for both sets of rules.

**Wild Card Cricket** 1 to 8 Players

Instead of the traditional numbers, this game will start with a random selection of six numbers from 7 through 20 (the bullseye will always be present). All numbers are “Wild” and will change at the end of each player’s turn if not marked. Once a number is marked, it will remain the same throughout the rest of the game. A 200 point spread limit is the default.

**Cricket Quickie** 1 to 8 players

This game plays exactly like Cricket except this game only has a round limit of 10. Because of its short round limit it is also less expensive than regular Cricket. The final difference is that this game has no spread limit.

**C. Other Games**

Here are some other fun games to play. Each one has a different set of rules so please read their individual entries.

**Speed Games**

These two games allow a single player to compete against the clock.

**Count Down**

The clock times how long it takes to go from 901 to exactly zero. When a game is completed within the ten fastest times, an input screen appears, where the player adds their name to the Top Ten List.

**Quick Cricket**

The clock shows how long it takes to close the 15 through 20 and the bullseye. Three marks are required to close a number, as in regular Cricket. No points are scored for extra hits on closed numbers. When a game is completed within the ten fastest times, an input screen appears, where the player adds their name to the Top Ten List.

**Count Up** 1 to 8 Players

Count Up is a good game to begin learning darts, allowing the player to develop throwing technique without being distracted by strategy. Each player begins with zero points and tries to score the most points to win the game. All segments will score points and a winner is declared at the end of 8 rounds.

**Gotcha! Open/Open** 2 to 4 players

The object of the game is to be the first player to go from zero to exactly 301 points. Players may try to match their opponent(s) score at which time a bomb is detonated destroying the opponents score and setting it back to zero. If someone exceeds 301, the amount exceeded will be deducted from your original score for that turn. No matching bombs will be detonated.

There is also a “Master Out” option, requiring a double, triple, or bull to reach exactly 301 points and win the game.



## Gotcha! Open/Master

2 to 4 players

Gotcha! Open/Master plays exactly as above except that it requires a double, triple, or bull to reach exactly 301 points and win the game.

## Bermuda Triangle

1 to 8 players

Players shoot at a new number each round. The numbers used are 12, 13, 14, Double, 15, 16, 17, Triple, 18, 19, 20, Bull, and Double Bull. Hitting any segment of the current number accumulates points for the player. For example: The first number is 12. A single will score 12 points, a double 24, and a triple 36. When “Double” is the current target, any double will score. The same applies to “Triple” when it is the current target. When a player misses the current number with all three darts, their current total score is cut in half! The highest score at the end of the game wins.

## Tic Tac Darts

2 Players

This is a variation of traditional Tic Tac Toe. The same nine square grid is used. The machine places the bullseye in the center square with randomly selected numbers in the other eight squares. Player “X” or player “O” claim a square by marking the number four times. Singles score 1 mark, doubles 2, and triples 3. The bullseye scores 1 mark; double bull (if used) will score 1 for the outer and 2 for the inner. The first player to get three squares in a row is declared the winner. In the event of a “Cats” game, where it is not possible to have three squares in a row, the game ends with player with the most points being declared the winner.

## Shark Tank

2-4 Players

The survival Count-Up game! The last surfer still surfing wins the game. Players try to be the “Best Surfer” for the round. All segments are valid except Bulls. Bulls score 0 points.

Only one player can have the highest score each round. Each player below him has a bite taken out of their surf boards. The board can only be bitten 6 times before you are eaten and lose.

If the “Best Surfer”’s score is double or more than yours, the shark will take two bites from your board. If any player ties the top surfer, every player gets bitten. The game is over when all but one player is eaten.

Remember, you don’t have to be better than the shark, just better than your friends.

## 4.3 Service Mode

Service Mode is where you configure all the options that the Galaxy 3 has to offer.

To enter the Service Mode, press the Service Button on the IOB Card.

### A. Machine Setup Menu.

**Language Setup:** Used to set the display language on the machine.

**Time Settings Menu:** Used to access current date and time, Happy Hour and Hours of Operation time settings.

**Set Time/Date:** Used to set the machine’s clock and internal calendar.

**Set Happy Hour Times:** Allows the operator to offer reduced game pricing for a set period each day. To activate this feature, the time period must be set on this screen and the reduced credits (Happy Hour) set in the Price Settings screen.

**Set Hours of Operation Times:** Setting the location’s Hours of Operation will allow the machine to enter **Sleep Mode** outside normal business hours. In Sleep Mode, the target lights will dim and the monitor screen will blank out. While in Sleep Mode, inserting a coin or pressing any button will return the machine to Normal Mode.

**Coin Slot Assignment:** Used to set coins per credit and credits per coin. Adjust the number of coins that have to be inserted to register the number of credits shown or adjust the number of credits that will register for the number of coins shown. Default: 1 coin = 1 credit.

**View/Edit Machine Name:** Used to input a “human friendly” name for each machine.

**Free Play:** Used to set free play on or off.

**Coinbox Button:** Allows you to switch the Coinbox Service button from Service Menu (full access) or Collector Mode (Collection screens only).

**More Machine Setup:** Contains the following setup options.

**Reset Menu:**

**Reset All:** A one-step method of activating all the resets listed on this menu.

**Reset to Factory Defaults:** Resets all options to the original factory setting.

**Reset Popularity Counters:** Resets all the counters back to zero.

**Reset League Stats:** Clears all stored match statistics.  
**Warning: Once they have been cleared they cannot be retrieved. Make sure all stats have been collected from the machine prior to using this function!**

**Clear Machine Credits:** Clears any accumulated credits from the machine.

**Clear Top Ten Score Lists:** This menu lets you reset the top ten score screens.

**Clear Bermuda Top Ten List:** Clears information stored in this list.

**Reset Team Hammer Cricket Top Ten List:** Clears information stored in this list.

**Reset Hammer Cricket Top Ten List:** Clears information stored in this list.

**Reset Count Up Top Ten List:** Clears information stored in this list.

**Clear Casual Stats:** Clears the last game stats for NDA mode.

#### League Attract Menu:

**List League Files:** Lists the league and graphic files currently on the machine and includes memory size information.

**View Attract Files:** Displays all operator ads on the board. This is good for troubleshooting.

**Delete League/Attract Files:** Allows league and graphic files to be selectively deleted.

**Delete All League/Attract Files:** Used to delete ALL the league and graphic files from the machine.

**One Liners:** This Option turns on and off the One Liners (little jokes and quotes that scroll through the Attract Mode)

**View Stats:** Allows you view new data that has been put on the Galaxy 3.

**Adjust Volume:** Allows the operator to adjust the speaker volume.

#### HotButton Menu:

**Create HotButton:** Allows the Operator to create Player, Operator and Collector HotButtons.

**Erase HotButton:** Erases the data stored on a HotButton.

**View HotButton Configuration:** Used to view the settings that were setup in Dartman, like Minimum Credits allowed and HotButton promotions.

**Delete HotButton Configuration:** Deletes the HotButton configuration off of the board.

**Write Settings to HotButton:** Writes the machine configuration to an Operator HotButton.

**Read Settings from a HotButton:** Loads the settings to the Galaxy 3 from an Operator HotButton.

**LED Lights Setup:** This menu allows you to adjust the LED's color on each of the LED panels as well as overall brightness.

**Target/Missed Dart Detector Setup:** This menu allows you to configure various target and Missed Dart Detector settings.

**Adjust Missed Dart Detector Sensitivity:** Allows you to adjust the sensitivity of the missed dart detector or you can turn it off.

**MDD Enabled:** You can turn ON or OFF the Missed Dart Detector.

**Door Latch Sensor:** The door latch sensor detects if you are touching the door latch. With it turned on the cheater alarm will not go off or cause a "Miss" during a game.

**Setup USB Backups:** You can configure a USB Thumb drive to store backups. See section 8.2 for further details.

**Monitor Setup:** This menu allows you to configure monitor options.

**Startup Auto-Configuration:** This **Enables** or **Disables** the feature that automatically configures the screen resolution of all monitors attached to the Galaxy 3.

**Auto Configure Now:** Forces a monitor configuration.

## B. Game Setup Menu

**Price Settings:** Used to set the number of credits required by each player in normal game mode and happy hour mode, for each individual game.

**Bull Setting:** Used to set the single or double bull for each individual game.

**Round Limit Setting:** Used to set round limits for each individual game.

**Spread Limit Setting:** Used to set Spread Limits on or off for Cricket games.

**Feat Settings:** This option lets you turn on/off feats for everything or specific modes.

**Global Feats:** Turns on/off feats for everything.

**League Mode Feats:** Turns on/off feats for League Mode.

**Remote Play Feats:** Turns on/off feats for Remote Play.

**Stat Ticker:** The **Stat Ticker** keeps track of every players average for the game they are playing.

**X01 Stat:** The **Stat Ticker** for X01 games can be configured to display PPD (Points Per Dart) or PPR (Points Per Round).

**Top Gun Setup:** These are the options for the Top Gun Challenge option.

**Enabled;** Toggle this mode ON or OFF.

**Best Of Games:** Change the “Best of” setting between 2 of 3, 3 of 5, or 4 of 7.

**Player Expiration (Days):** Set the amount of days that a player can go without playing Top Gun Challenge before they are removed from the Top Gun Challenge list.

**Top Gun Fee (Per Player):** You can increase the amount of credits it takes to play the Top Gun Challenge.

**Clear Top Gun List:** This deletes everyone on the Top Gun List. This option is used usually when moving the dartboard to another location or vendor.

**More Game Setup:** Used to access the following items:

**Auto Player Change:** Used to set auto player change on or off.

**Player Change Delay:** Used to set the time, in seconds, allowed to remove darts between player turns.

**Cheater Alarm:** Used to set free dart sound on or off. When set to ON, the machine will make an alarm sound when players throw darts without inserting any credits. Used to discourage free play.

**Team Fees:** Used to have the machine automatically collect league dues from each team prior to a match. Can be turned “ON” or “OFF” The amount to collect is determined and sent by Arachnid’s League Management Software.

**Casual Freeze Rule:** Turns off and on the freeze rule for casual play.

**Freeze Rule Bust:** When this option is set to on, it will allow a player breaking the freeze rule to go bust instead of losing the game.

**Backup Dart:** Turns off and on the unthrow option in casual mode.

**Casual Mode Handicap (X01):** Turns off and on handicapping for casual mode. The percentage is used to determine the minimum starting score for the lowest player. (i.e., 40% of 301 is 121 or 60% of 301 is 181).

**Casual Mode Handicap (Cricket):** Turns off and on handicapping for casual mode. You can choose how many spot marks to give the less skilled player.

**League Round Limits:** Turns off and on the round limits for leagues. This uses the round limits set up for casual play.

**League Freeze Display:** Turns off and on the Freeze Rule display in leagues.

**League Pay Ahead:** Turns on and off the Game Fees Screen. With this option on, your players pay for the night’s games up front.

**League Cancel Button:** Turns on and off the Exit League Play feature. When turned on, you have the option to exit league play before starting the next game.

**Allow HotButton Credits in Leagues:** This allows a player to use credits that are stored on his HotButton to pay for league dues.

**New Team Cricket Rules:** Turns on and off the New rules for Team Cricket. If the New Team Cricket rules is switched on, both casual and league play will use the new rules that were detailed earlier in this manual.

**Enable Top Ten Lists:** Turns on or off the Top Ten Lists. The Top Ten Lists display the top ten players that have played that game. The current Top Ten Games are:

Bermuda  
Team Hammer Cricket  
Hammer Cricket  
Count Up

**Use Large cameras in Offline Games:** This turns on or off the larger camera feeds in casual games.

## C. Communications

**Connections Setup:** This section is where we choose the type of device we are using to communicate with the league system.

**Ethernet Setup:** This setup is for using an ethernet cable and plugging directly into a router or the highspeed internet modem.

**Enabled:** Toggle this on or off to enable or disable ethernet communications.

**Use Internet:** Toggled to YES, you are informing the Galaxy 3 that you want to use the ethernet to talk to LeagueLeader.

**IP Setting:** This option allows you to choose whether to manually enter in Internet information or let it automatically find it for you.

**IP Address:** This is the address that your Galaxy 3 uses to access the Internet. If you chose **Manual** under **Auto/Manual**, you will need to set an IP Address manually.

**Netmask:** Provided by your Internet provider.

**Gateway:** Provided by your Internet provider.

**DNS Server 1:** Provided by your Internet provider.

**DNS Server 2:** Provided by your Internet provider.

**WIFI Setup:** If you have installed a WIFI Modem, this menu allows you to change the settings of your wireless network.

**Access Point:** This is the name of the wireless access point connected to your Galaxy 3 machine.

**Security Type:** This is the security type for your wireless access point. You can choose either WEP, WPA TKIP, WPA2 AES or None.

*Note: The Galaxy 3 will only work with the listed Security types. If the router isn't set to one of the security types listed, it will not work.*

**Security Key:** This is the "password" used when connecting to a secure wireless network. Both access point and Galaxy 3 must have the same key in order to work.

**Use Internet:** Toggled to YES, you are informing the Galaxy 3 that you want to use the ethernet to talk to LeagueLeader.

**IP Setting:** This option allows you to choose whether to manually enter in Internet information or let it automatically find it for you.

**IP Address:** This is the address that your Galaxy 3 uses to access the Internet. If you chose **Manual** under **Auto/Manual**, you will need to set an IP Address manually.

**Netmask:** Provided by your Internet provider.

**Gateway:** Provided by your Internet provider.

**DNS Server 1:** Provided by your Internet provider.

**DNS Server 2:** Provided by your Internet provider.

**Modem Setup:** If you have installed an Analog Modem, this menu allows you to change the settings of your wireless network.

**ISP Dumb Mode:** Some Internet Service Providers might require this to be turned on. It's just a different mode of communication.

**Galaxy 2 Network:** Use this if you are connecting multiple Galaxy II machines to this Galaxy 3.

**Reconfigure Legacy Network:** Is used to examine the entire network of machines and configure network machine node numbers. Shows the status of each node on the network. This step is required to be done from the modem machine.

**View Network Configuration:** Shows the last known status of all machines on the network.

**Adjust Network Speed:** Used to set the network transmission speed. If Galaxy or Black Widow machines are networked with Galaxy 3 machines, the network speed must be set to 9600. If only Galaxy 3 and Galaxy II machines are networked, any speed can be used, but they all must be set to the same speed.

**Network Monitor:** Displays all network data sent by the machine in yellow and all network data received in white.

**Network Send Test:** Tests the ability of the machine to send data across the network. (Displays the alphabet in yellow as the characters are being sent.) Used in conjunction with another machine running the Network Receive Test (see below) to verify network communications. Red characters indicate a problem.

**Network Receive Test:** Tests the ability of a machine to receive data across the network. (See Network Send Test above.) When another machine is set up to send the receiving machine will display the alphabet in white letters as they are being received. Red characters indicate a problem.

**Repropagate:** Sends League Files and Machine settings to the Galaxy II's on the network.

**Network Help:** Displays frequently used information on network setup for the technician.

**Port Forwarding (Remote Play):** This is used to setup the necessary settings for Remote Play.

**UPnP (Auto):** Will automatically setup the ports necessary for **Remote Play** to work. This also needs to be turned on in your router.

**Port Forwarding:** If UPnP doesn't work, You can assign a specific port for each Galaxy 3. By default the Galaxy 3's start at 2500/2500. If you have another Galaxy 3 in the location, set their **Port Forwarding** at 2501/2501 and so on.

**LeagueLeader Setup:** This menu provides information concerning connecting with LeagueLeader.

**Connection Method:** This is the type of communication you use to communicate with LeagueLeader.

**Ethernet:** Used to communicate to LeagueLeader using a digital modem.

**Modem (Internet):** This method is used with analog modems calling a dial up network.

**Modem (LeagueComm):** This method means that your computer communicates directly with the Galaxy 3 by analog modem.

**Ethernet Device Settings:** This option will only display if Ethernet is chosen. It will open **Ethernet Setup**.

**Modem Settings:** This option will only display if **Modem (Internet)** or **Modem (LeagueComm)** is chosen. It will open **Modem Setup**.

**ISP Phone Number:** This the dial up number that the Galaxy 3 will use to call the internet. This option will only appear if **Modem (Internet)** is selected.

**ISP Username:** Input your LeagueLeader ISP user name here. This option will only appear if **Modem (Internet)** is selected.

**ISP Password:** Input your LeagueLeader ISP Password here. This option will only appear if **Modem (Internet)** is selected.

**LeagueLeader Account Settings:** This section is where you enter in your LeagueLeader FTP Username and Password.

**View Outgoing Call Window:** Used to set the number of rings within the call window and outside the call window, after which the modem will pick up an incoming call. The call window is defined by the beginning time and ending time set on this screen. This feature is contingent on the machine having the correct time set.

**View Last Update:** From this menu, you can see the last Galaxy 3's last communication.

**View Call Log:** This will display a report of what happened during the last communication to LeagueLeader.

**Clear Last Update Time:** Clears the call log.

**Perform Update:** Used to force the machine to call out immediately.

## D. Reports

**Game Popularity Counter:** Displays a history of machine usage. Shows all games on the machine, the number of times each game was played and the number of credits collected toward each game.

**Coin/Credit report:** This menu has 4 reports that are useful for collectors.

**Credits Collection Report:** Displays credits taken in (since last reset) for game play, league dues, HotButton Credits Spent and Used and Game Credits. It also displays Total Permanent Counters.

**Added Credits/Coins:** Displays the number of credits taken in by each of the coin slots individually and HotButton credits spent.

**Used Credits:** This report splits up the credits added to the board into individual categories. It shows both Permanent Credits and New Credits.

**Show Coin Slot Report:** This option allows you to turn on or off the second page of the Add Credits/Coins report (i.e., Add Credits/Coins).

## E. Diagnostics

**Abort In Progress League:** Stops any league that is currently running.

**Collect Diagnostic Data:** This is used to gather software and device data that may help troubleshoot a problem. Only use if you are instructed to by Arachnid Technical Support.

**Target Test:** Starting with the Double 20, this will ask you to tap various segments. The segment you hit will make a positive sound if it is the correct segment and a negative sound if it is wrong. This will help you find stuck segments as well as making sure all the segments score properly.

**LED Test:** Technicians can use this to test the LED's on the side panels. It will scroll through the various colors.

**Remote Play Diagnostics:** This menu will allow you to test every aspect of Remote Play.

**Debug Logging:** This is another tool that Arachnid Techsupport can use to trouble shoot a problem. Only use if you are instructed to by Arachnid Technical Support.

**Restart Software:** Used to exit the Software Update Menu and reboot the Galaxy 3 software.

## Section 5 Technical Description

Below are technical descriptions of the many parts within the Galaxy 3.

### 5.1 Monitor

19" Wide LCD Monitor

### 5.2 Power Supply

**ATX Switchable Power Supply:** 12 VDC, Switchable between 120 and 230 VAC

*Note: If the supply cord is damaged, it must be replaced by a special cord or assembly available from the manufacturer or its service agent.*

### 5.3 Hardware

**PC Board:** SATA 3GB/s DDR2 1066

**RAM:** 1024MB DDR2

**Hard Drive:** SATA 2.5" 40GB. Always make sure you have the current Build of Software.

## 5.4 Operating Conditions

The Galaxy 3 can be operated at 115~VAC or 220-240~VAC. There is a switch on the power supply to change between 115 Volts and 220-240 Volts.

### Power Draw

4.8A @ 120V~50/60 Hz

2.6A @ 220-240~50/60 Hz

**Warning: Make sure the voltage on the power supply is set correctly for the area you are in.**

## 5.5 Darthead

The Galaxy 3 is unique in that it has both a 15" and 13" darthead on the same game. The targets use the same backboard but have separate matrixes and matrix cushions.

A latch on the side of the catch ring allows you to flip the darthead. Pull the lever toward the target and push.

The darthead assembly for both sides consists of (from front to back): the spider and segments, a matrix cushion, and the switch matrix. This assembly is resting on two screws at the bottom and is secured to the door (back-board) by means of five spider retaining latches.

## 5.6 Target Interface Board

The switch matrixes are connected to the Target Interface Board via the 38 pins of J1. For troubleshooting purposes, it is important to know which pins on J1 will give a particular score. Check **Section 8 Maintenance** for more information.

## 5.7 Missed Dart Detector

Built directly onto the Target Interface Board, the Missed Dart Detector detects any "missed" dart. In more technical terms, the missed dart detector senses any dart that hits the catch screen that surrounds the darthead.

If a missed dart is detected, the machine will record a dart thrown and no score will be given.

See **Section 3.6 Target Interface Board Basics** for information on adjusting the missed dart sensitivity.

## 5.8 Coin Door and Bill Acceptor

The Mars Bill Acceptors that works with the Coin/Bill Ready Doors are 2451 and 2651

## Section 6 Internet Communications

There are three ways to communicate with the internet from the Galaxy 3. For highspeed internet, you will need a working router, Ethernet and/or WiFi Communications.

### 6.1 LeagueLeader Setup

If you intend on using the Galaxy 3 for leagues or Remote Play, you need to add the settings to the machine.

*Note: You can set up the **Connections Method** from this menu or by going into their respective menus.*

1. Go into the setup mode by pressing the Service Button on the IOB.
2. Select **Communications**.
3. Select **LeagueLeader Setup**.
4. Choose the **Communications Method**. You have three choices: Ethernet, WiFi, or Modem (Internet). Each **Communications Method** will have different settings. You can set them up now by going into their respective settings menu right below Communications Method.
5. Enter in your **LeagueLeader Account Settings**. Here you will enter in your FTP Username and Password.
6. Once all settings are entered, including the Device Settings, click on **Perform Update** to test the connection.

### 6.2 Setting up a Wired Network (Ethernet)

Setting up a wired network, or ethernet, is fairly straight forward. The Galaxy 3's mainboard has a built in network card. You will need to have a properly set up router first.

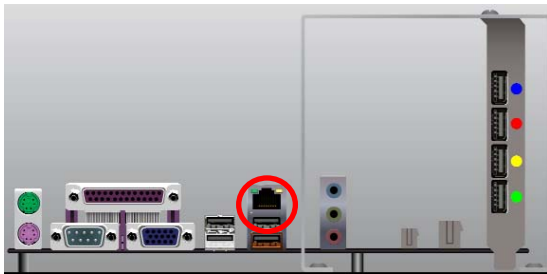

1. Run an Ethernet cable from the router to the Galaxy 3.
2. Slide the Ethernet cable between the upper and lower cabins in the back of the Galaxy 3.
3. Plug the Ethernet cable into the motherboard.
4. Go into the setup mode by pressing the Service Button on the IOB.
5. Select **Communications**.
6. Select **Connections Setup**. Choose **Ethernet**.
7. Make sure **Enabled** is toggled "YES".
8. Make sure **Internet** is toggled "YES".

9. For ease of use, make sure **IP Setting** is set to "Auto (DHCP)". This will configure all the other Internet settings for you.
10. Once setup, Return to Previous Menu.
11. Select **LeagueLeader Setup**.
12. **Connection Method** should be already selected for you, select **LeagueLeader Account Settings**.
13. Input your LeagueLeader FTP Settings.
14. Once all finished, select **Return to Previous Menu**.
15. Select **Perform Update**.

### 6.3 Setting up a Wireless Network

Setting up a wireless network is different than a wired network. You will need to have a properly set up router first.

1. Unplug the Galaxy 3.
2. Unlock and open the bezel and monitor.
3. Plug in the wireless card on to the motherboard. See A1 (page 19) for our list of recommended Wireless Cards.
4. Secure the PCI Card to the bracket with a screw.

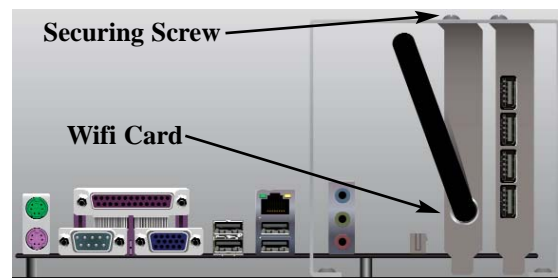

5. Plug in the Galaxy 3.
6. Go into the setup mode by pressing the Service Button on the IOB.
7. Select **Communications**.
8. Select **Connection Setup**. Choose **WiFi Setup**.
9. Make sure **Enabled** is toggled "YES".
10. Make sure **Internet** is toggled "YES".
11. Click on **Access Point**. This will scan the local area for any wireless access points.
12. Choose the access point you intend to use. Depending on the area, more than one access point may be displayed. The signal strength and the security type will be listed by each access point.
13. The **Security Type** should be automatically assigned.
14. Enter in the **Security Key** or **Pass Phrase**.
  - ♦ WEP uses an **Encryption Key**. The key is ten (10) characters long and made out of the numbers 0-9 and the letters a-h.
  - ♦ WPA and WPA2 can use an **Encryption Key** like WEP, but they also have access to a **Passphrase**. This Passphrase can be any combination of letters (upper and lowercase) and numbers.
15. Select **IP Setting**.
  - ♦ Auto (DHCP) will automatically find all the internet settings it needs.
  - ♦ Manual will require you to get the I.P. Address, Net Mask and other internet settings yourself.



16. Select **Return to Previous Menu** once finished.
17. Select **Return to Previous Menu** again.
18. Select **LeagueLeader Settings**.
19. **Connection Method** should be already selected for you, select **LeagueLeader Account Settings**.
20. Input your LeagueLeader FTP Settings.
21. Once all finished, select **Return to Previous Menu**.
22. Select **Perform Update**.

## 6.4 Setting up a Dialup Modem

The Galaxy 3's can be set up to call out using a dialup modem. The Galaxy 3 will use a normal analog phone line to send and retrieve data from LeagueLeader.

1. Unplug the Galaxy 3.
2. Unlock and open the bezel and monitor.
3. Plug in the modem on to the motherboard. See A1 (page 19) for our list of recommended Modems.
  - a. If it's a PCI modem secure the PCI Card to the bracket with a screw.
  - b. If its a USB modem, plug the USB cable into the open USB port underneath the ethernet port.

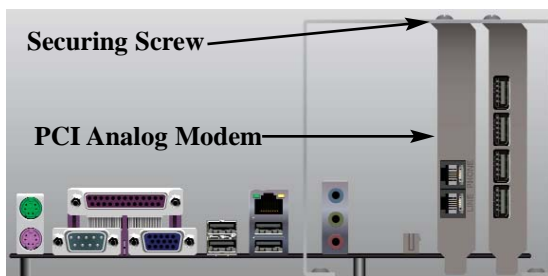

Galaxy 3 Ground Plane With a PCI Analog Modem

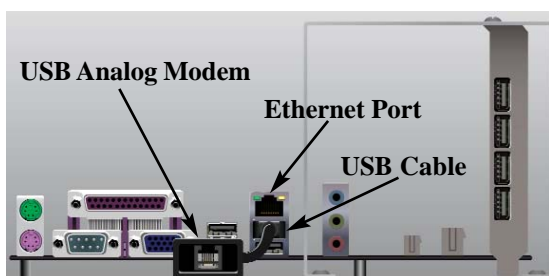

Galaxy 3 Ground Plane With a USB Analog Modem

4. Open the **Service Menu**.
5. Select **Communications**.
6. Select **LeagueLeader Setup**.
7. Select **Modem (Internet)** for the Connection Method.
8. Select **LeagueLeader Account Settings**. In this menu, enter in your FTP Username and Password.
9. Enter in your ISP Phone Number. This can be gotten from [www.dialupusa.net](http://www.dialupusa.net).
10. Enter in your ISP Username and Password. These you were given after you signed up for LeagueLeader.
11. Click **Return to Previous Menu**.
12. Click Perform Update to test the connection. This will force a call to LeagueLeader and download any files ready to be downloaded.

## Section 7 Network Communications

A network can be set up between multiple boards in a location so that you only need to use one board to communicate with LeagueLeader. There are several ways this can be done.

### 7.1 Connecting to a Galaxy II

The Galaxy 3 can be connected to a Galaxy II/Galaxy II.5 network using a crossover phone line. Galaxy 3's should always be the master of the network.

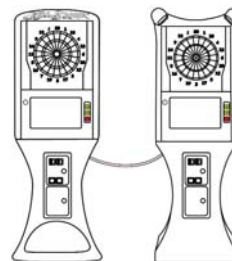

1. Set the dip switches on the Galaxy III's IOB (see 3.5) so that it is in the MASTER position.
2. Set the dip switches on the end dart machines so that 3 is on.
3. Set all of the dip switches on any middle boards to OFF.

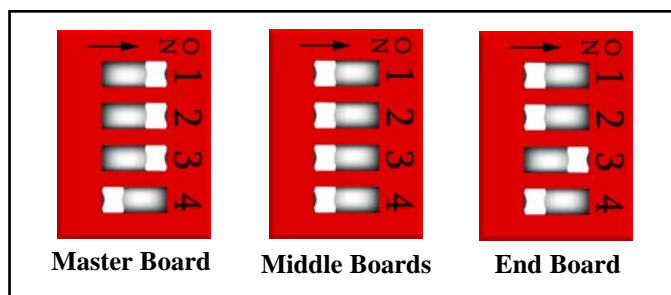

4. Use a regular flat cross over phone line as the network cable for boards less that 15' away.
  - ⇒ For dart machines that are more than 15' away use round phone line with modular jacks. Use a flat phone line to go from the modular jacks to the dart machines.
5. The "network line" must alternate between COMM IN to COMM OUT between dart machines. See Section 3.5.

*Note: If this is not done your network will not function properly.*

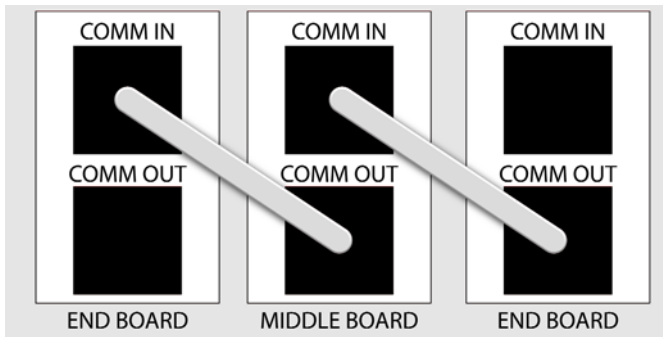

6. Make sure the network speeds are the same.
  - ⇒ The network speed on the Galaxy 3 can be found under Communications>Galaxy II Network Setup>Adjust Network Speed.
  - ⇒ The network speed on the Galaxy II/Galaxy II.5 can be found under Communications>Network>Adjust Network Speed.
7. Configure the network. This is located in the Setup Menu under Communications>Galaxy II Network Setup>Reconfigure Legacy Network.
  - ⇒ Configure the network **only** from the Galaxy 3.
  - ⇒ All Galaxy II slaves will display a message stating “Detecting Galaxy II nodes. Press any button to configure.” Once you see this message press any button to configure that node. After all slaves have been configured, press **Done** on the Galaxy 3.
8. Make sure the network is configured properly by going to the Setup Menu and selecting View Network Configuration under Communications>Galaxy II Network Setup
  - ⇒ A yellow light is displayed for the board you are currently on. A green light is used for any networked boards.
9. Perform Network Send and Receive Tests throughout the network if necessary. These tests are located in the under Communications>Galaxy II Network Setup. The Send Test should display a yellow alphabet and the Receive Test should display a white alphabet.

*Note: If any red letters appear then there is a problem with the network. If problems occur, retrace your steps.*

It is possible to have multiple Galaxy 3's controlling multiple Galaxy II networks in one location. Add the Galaxy 3's into LeagueLeader both as masters with the Galaxy II's as slaves. The Galaxy 3's should be setup as described in Section 6.

## 7.2 Other Methods of Connecting Multiple Galaxy 3's Together

While it is true you can connect multiple Galaxy 3's to a “Master” machine (like in a Galaxy 2 network), it will be much easier to just make each machine it's own master.

This means you will need to input multiple masters into LeagueLeader along with every boards screen ID. It also makes communication and collecting boards much faster.

## Section 8 Maintenance

This section is basic information on maintenance for your Galaxy 3 and how to perform some simple maintenance tasks at the machine.

### 8.1 Cleaning the Darthead

Inevitably, during the course of several months of play, a tip from a dart will get broken and lodged into the dart board. Owners of previous Arachnid Dartboards know how to fix and maintain their dartboards.

This section will explain how to remove broken dart tips, clean the matrix and segments and how to test the Target Interface Board (TI).

#### A. Removing Broken Tips

Each segment of either darthead on the Galaxy 3 has a back to it. So when a player gets a broken tip or a tech goes to service a board, all they have to do is push the tip through the hole. Because the segment is capped, the broken tip can't fall anywhere and interfere with the electronics. To do this, you will need a sturdy tool that will fit through the segment hole. A dart tip won't work.

A lot of times the tip has enough material sticking out of the hole where you can simply pull out the tip with a pair of pliers.

#### B. Disassembling the Darthead

Maintaining dartheads means that sometimes you will need to get at the inner workings of the darthead: the segments, the rubber mat and matrix.

Start by making sure the 15" darthead is in front.

1. Remove the four (4) Screws holding the catch screen in place with a 3/32" Allen Wrench.

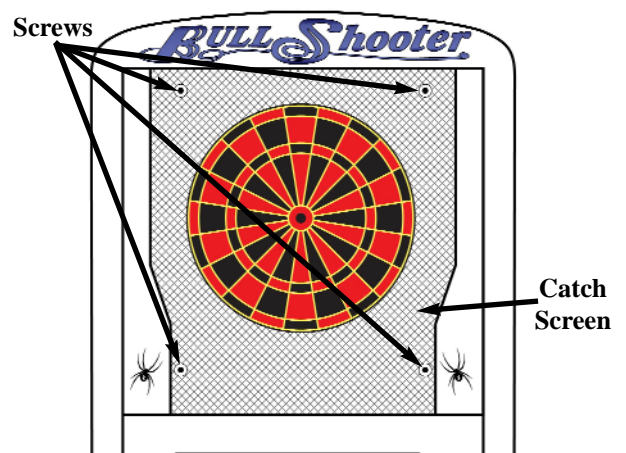

2. Remove catch screen from the darthead.

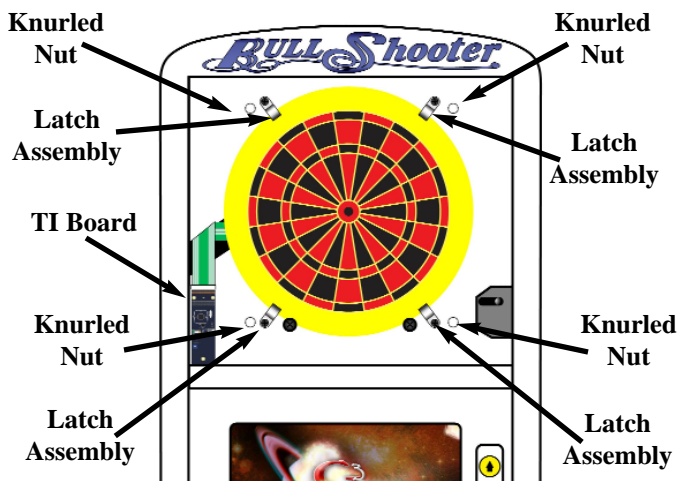

7. Use a clean damp cloth to wipe down the matrix and rubber mat.

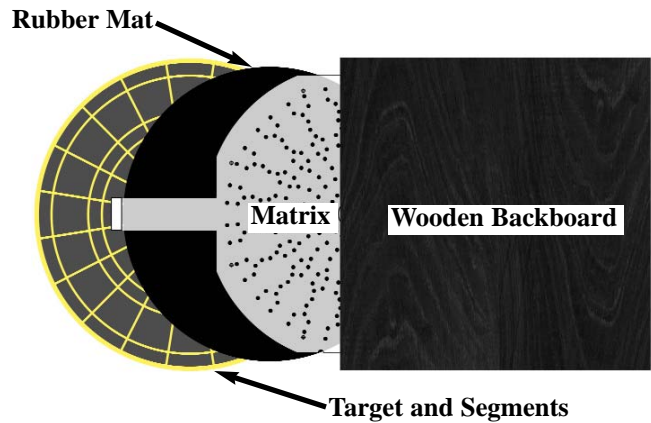

3. Unplug the Matrix ribbon cables from the Target Interface (TI) Board.

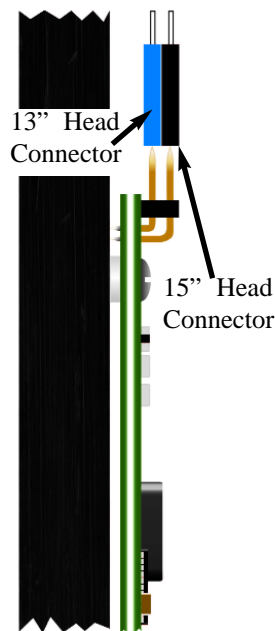

8. Remove the backs of each segment and dump its contents (if any) into the garbage.
9. Check over the segments and clean up any broken plastic.
10. Wipe down the sides of the segments. Make sure they are completely free of debris and are dry before replacing them in the web.
11. Reassemble the darthead and do the opposite side.

*Note: Make sure you get the darthead in the correct order. If the any of the pieces are misaligned or out of sequence, the players will have difficulty scoring.*

We suggest performing darthead maintenance before each season. This will reduce the amount of service calls you are likely to get. However, it really all depends on the amount of play the dartboard receives at each location.

If its a location that is heavy into dart leagues, you might want to perform maintenance more often.

4. Turn the Latch Assemblys so that they are no longer holding the darthead to the back board. Start with the upper left Latch Assembly and end with the lower left Latch Assembly

*Note: You will want to hold the darthead to the backboard while you perform step four (4). The darthead could be damaged if it were to fall.*

5. Carefully remove the darthead.
6. Lay the darthead on a flat surface. At this point you may want to mark which end is the 20.

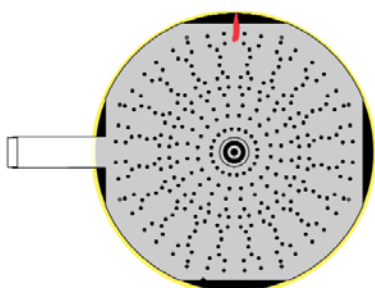

### C. Testing the Target Interface Board

Both the 15" and the 13" switch matrix are connected to the Target Interface Board (TI Board) at the 38 pin connector J2. The front nineteen (19) pins are used for the 15" darthead and the back nineteen (19) pins are for the 13" darthead.

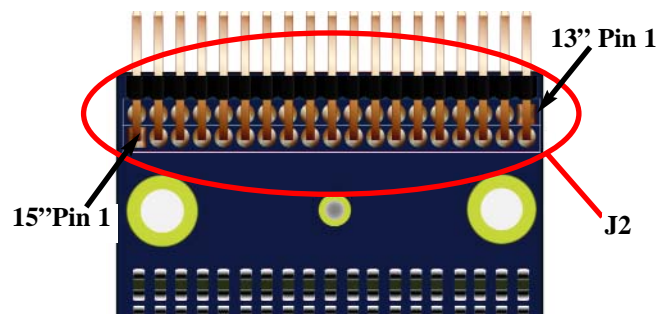

You can only access the Target Interface board from the 15" side of the darthead. The first step is to remove the web on the darthead.

1. Remove the four (4) Screws holding the web in place.

- Remove catch screen from the darthead.

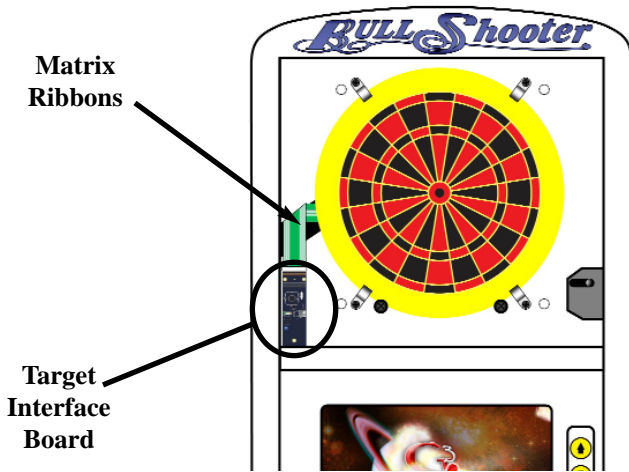
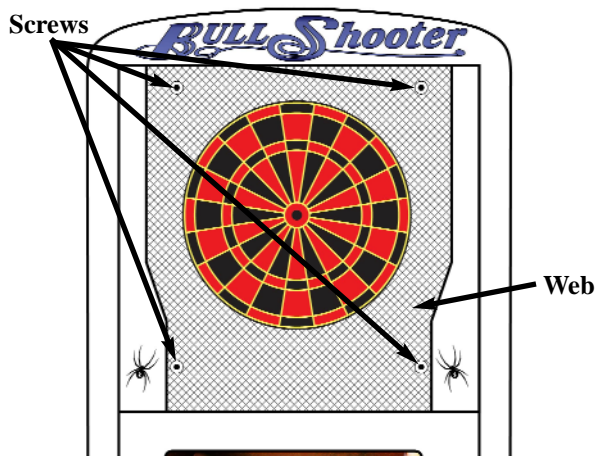

*Note: You can only do this test from the 15" side. There is no way to easily access the Target Interface Board from the 13" side. This instructional will show you how to test both sides from the 15" side.*

- Unplug the matrix ribbon cables from the Target Interface (TI) Board.

*Warning: The pins on the Target Interface board can be bent when excessive force is used to remove the matrix ribbons.*

*Don't unplug either matrix by pulling on the ribbon. Unplug them using the connectors.*

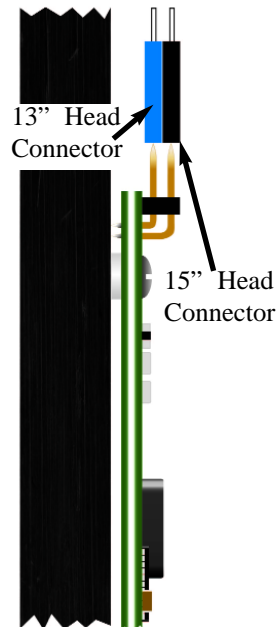

- Go into the **Service** menu on the Galaxy 3.
- Select **Diagnostics**.
- Select **Target Test**.
- Use a jumper and the chart below to test the individual pin combinations.

*Note: As stated earlier, this test can only be performed from the 15" side.*

If you follow the chart below, keeping in mind where the Pin 1 positions for each target are, you will get the results you are looking for. More information on where pin 1 is for each matrix connector is, refer to the diagram **TI Board Top View** on this page or **Section 3.6** on page 5.

Pin #	13	12	11	10	9	8	7	6
1	D20	O20	T20	I20	D19	O19	T19	I19
2	D5	O5	T5	I5	D7	O7	T7	I7
3	D12	O12	T12	I12	D16	O16	T16	I16
4	D9	O9	T9	I9	D8	O8	T8	I8
5	D14	O14	T14	I14	D11	O11	T11	I11
14			OB	IB				
15	D1	O1	T1	I1	D17	O17	T17	I17
16	D18	O18	T18	I18	D2	O2	T2	I2
17	D4	O4	T4	I4	D15	O15	T15	I15
18	D13	O13	T13	I13	D3	O3	T3	I3
19	D6	O6	T6	I6	D10	O10	T10	I10

**Galaxy 3 Matrix Pinout**

*Note: Only use the pins in the same row when testing the Target Interface Board. Nothing bad will happen. Your readings will just be inaccurate.*

**13" Darthead Pins**

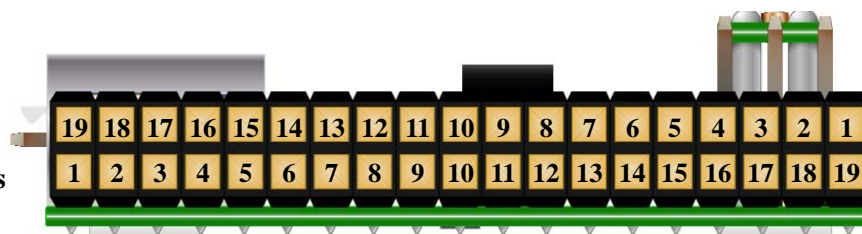

**TI Board Top View**

**15" Darthead Pins**



## 8.2 USB Backups

The Galaxy 3 Has the ability to back up league stats to a flash drive. This feature was designed as a way to ensure you get league stats even if something happens to the hard drive.

You will need an empty thumb drive. There is no size limit for these thumb drives. The files that are being backed up are relatively small.

*Note: Do not use this as your normal method of communication with the boards.*

*Warning: This is not the method you use to collect stats manually from the Galaxy 3. See the LeagueLeader manual for that information.*

1. Enter **Setup Menu**.
2. Select **Machine Setup**.
3. Select **More Machine Setup**.
4. Take a blank thumb drive and plug it into the first USB port right under the ethernet port. This should be the only one not in use and should be easy to find.
5. Select **Setup USB Backups**. You will get a message asking you if you want to format the thumb drive.
6. Press the Red button to enable the USB Backup.

Thats basically it. You can leave the Backup Drive attached to the Galaxy 3 and it will continue to make back ups.

### Loading the USB Backups into LeagueLeader

Now that we have a USB back up, you need to know how to load the data it's saved into ILeagueLeader.

1. On the Galaxy 3, enter **Setup Menu**.
2. Select **Machine Setup**.
3. Select **More Machine Setup**.
4. Select **Stop USB Backups**.
5. Remove the USB thumb drive.
6. At your computer, open LeagueComm.
7. Insert the USB backup drive into one of your computers open USB slots.
8. Click on **Upload Stats From Drive**.
9. Click on **Load Stats Into Leagues**.

## 8.3 Adjusting the Target Camera

The player camera comes pre-adjusted but you will need to adjust the target camera.

1. Power on the Galaxy 3.
2. Go into Casual Play. You will need to use the video feed on the screen to help adjust the camera.



3. Looking through the target camera opening, locate the adjustment hole in the camera. It is located just below the lens.
4. Insert the 3/32" allen wrench into the cameras adjustment hole.



5. Using the video feed, adjust the camera so that it is facing the target.

*Note: Clockwise rotation of the camera mounting block rotates the image on the screen clockwise. Counterclockwise rotation of the camera mounting block rotates the image on the screen counterclockwise.*

6. Once finished, insert the camera hole bezel in the game. It fits easier if the long side faces down and toward the target.

## Section 9 Parts Listing

The numbers listed are Arachnid part numbers. Please use the Arachnid numbers when placing an order. Some descriptions are followed by a number in parentheses. This number is the quantity used in that assembly.

**A** →  
43295 Upper Cabinet Assembly  
YRB/RWB Camera Ready

**B** →  
43102 USA Base Assembly 120VAC



# 43295 Upper Cabinet Assembly YRB/RWB Camera Ready



Part#	Ref#	Description
43017	1	Upper Cabinet G3
43316	1	Cooling Fan (Not Shown)
43116	1	Magnet (2) (Not Shown)
43146	1	Access Cover (Not Shown)(2)
43075	1	Speaker
43183	2	Marquee Assembly
43125	3	Dual Target Assembly YRB/RWB
43325	3	Dual Target Assembly INT/RWB
43185	4	Dartboard LED PCB W/Bracket (2)
43130	4	Dartboard LED Diffuser(2)
41676	5	Push Button - Up/Down (black/yellow) (2)
34811	6	Push Button Lamp GE 658 Bulb (3)
19131	6	Push Button - Player Change (black/red)
43213	7	Monitor with Bracket Assembly
43516	7	LED Monitor
43166	7	Monitor Bracket
41821	7	Monitor Power Cable (Not Shown)
43236	7	Monitor VGA Cable (Not Shown)
42115	8	Hot Button Probe
43314	9	Bezel w/Logo
43374		Ground Plane Assembly 120V (Inside Cabinet)
43375		Ground Plane Assembly 230V (Inside Cabinet)

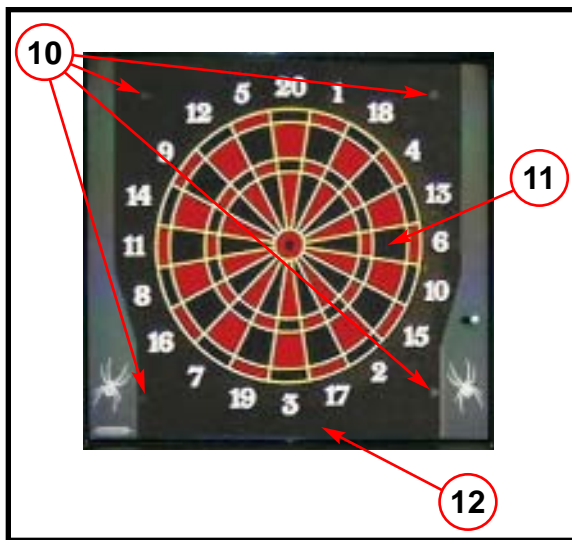

## 43125 Dual Target Assembly

Part#	Ref#	Description
43209	10	15" Web Mounting Screws (4)
37376	11	15" Yellow/Black/Red Spider and Segments Assembly
43322	11	15" International Spider (White) and Segments Assembly
28258	11	15" Rubber Damper
12575	11	15" Switch Matrix
43121	12	15" Web
43170	13	15" Darthead Retaining Bracket Assembly
43162	14	Target Back
25956	15	Knurled Nut (8)
43425	16	TI (Target Interface) Board
43446	17	TI Board USB Cable
43149	18	Upper Pivot Bracket 15" Side
43133	18	Pivot Tube (2)
43159	19	Galaxy 3 Dual Head Latch Assembly
43150	20	Lower Pivot Bracket 15" Side

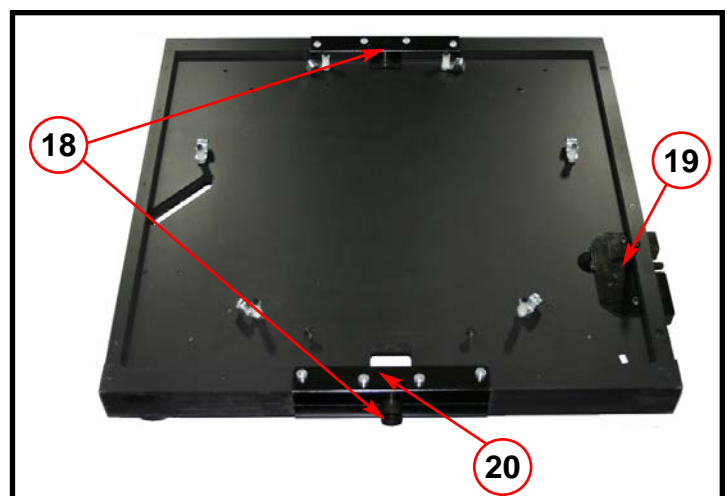
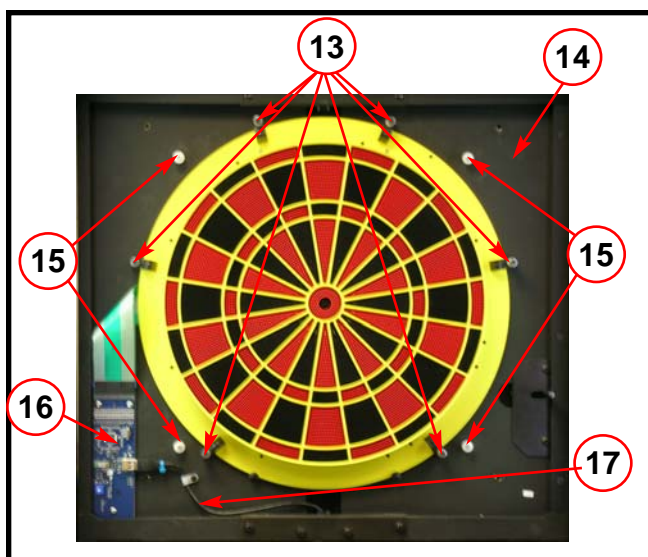





Part#	Ref#	Description
42582	21	13" Red/White/Blue Spider and Segments Assembly
35881	21	13" Rubber Damper
17015	21	13" Switch Matrix
43123	22	13" Web
43180	23	13" Darthead Retaining Bracket Assembly
43150	24	Upper Pivot Bracket 13" Side
43151	25	Lower Pivot Bracket 13" Side

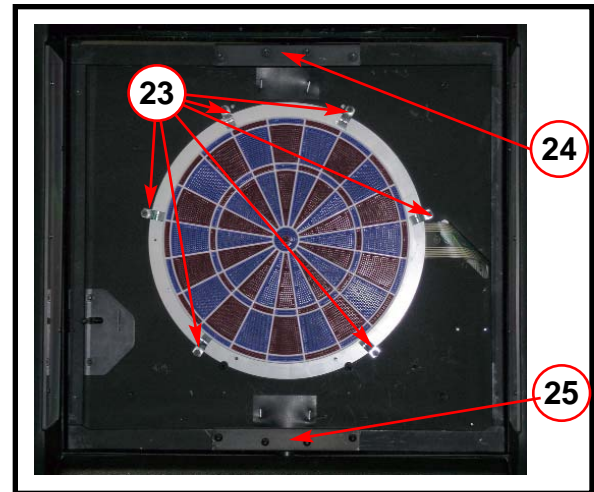
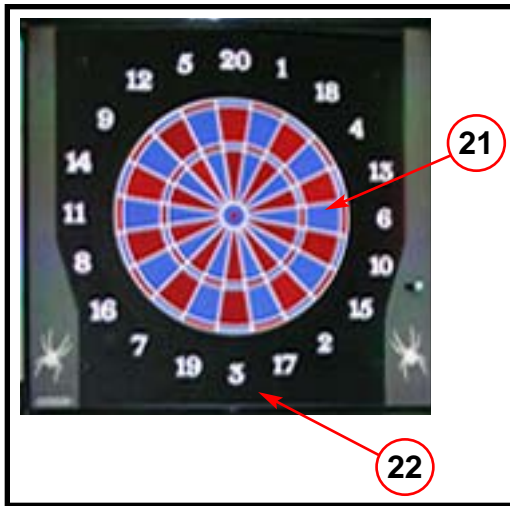

## 37376 Yellow/Black/Red (YBR) Spider and Segments Assembly

Part#	Ref#	Description
41590	26	Alignment Pin (2)
42036	26	Alignment Pin Screw (2)
29268	27	15" Spider Yellow
18069	28	15" Segment, Double Red (10)
19079	28	15" Segment, Double Black (10)
21408	29	15" Segment, Outer Single Red (10)
22518	29	15" Segment, Outer Single Black (10)
23628	30	15" Segment, Triple Red (10)
24738	30	15" Segment, Triple Black (10)
25848	31	15" Segment, Inner Single Red (10)
26958	31	15" Segment, Inner Single Black (10)
29078	32	15" Segment, Outer Bull Red
27148	33	15" Segment, Inner Bull Black
35845	34	15" Spring, Inner Bull

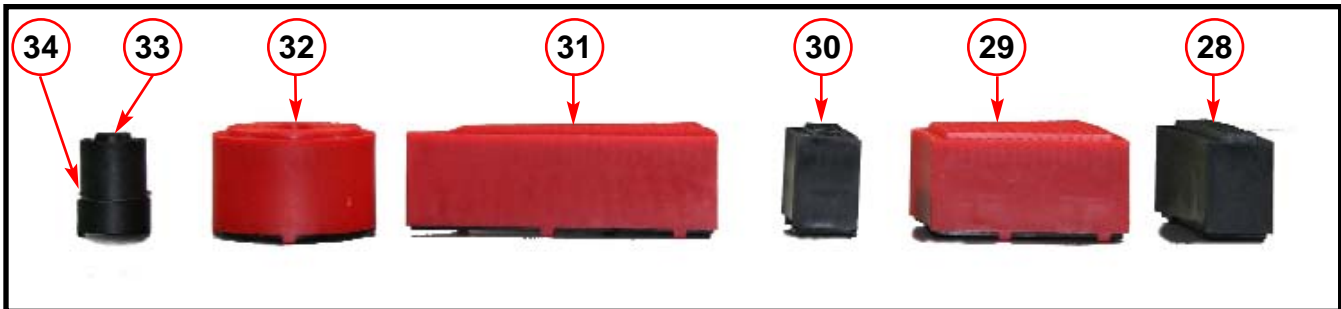
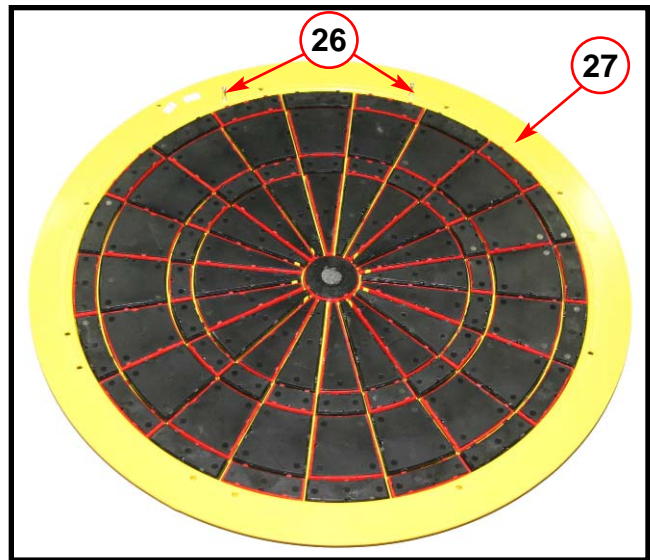

## 42582 Red/White/Blue (RWB) Spider and Segments Assembly

Part#	Ref#	Description
41590	35	Alignment Pin (2)
42036	35	Alignment Pin Screw (2)
42575	36	13" Spider
42616	37	13" Segment, Double Red (10)
42617	37	13" Segment, Double Blue (10)
42618	38	13" Segment, Outer Single Red (10)
42619	38	13" Segment, Outer Single Blue (10)
42620	39	13" Segment, Triple Red (10)
42621	39	13" Segment, Triple Blue (10)
42622	40	13" Segment, Inner Single Red (10)
42623	40	13" Segment, Inner Single Blue (10)
42580	41	13" Segment, Outer Bull Blue
42624	42	13" Segment, Inner Bull Red
36250	43	13" Spring, Inner Bull

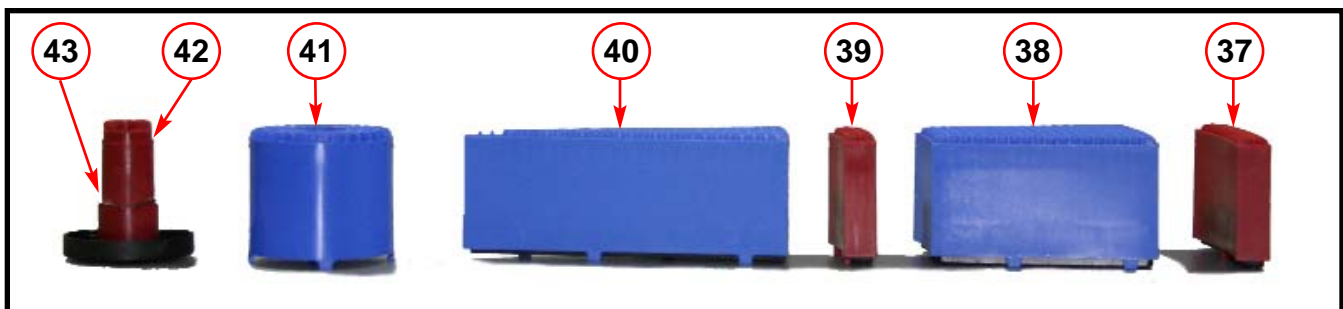
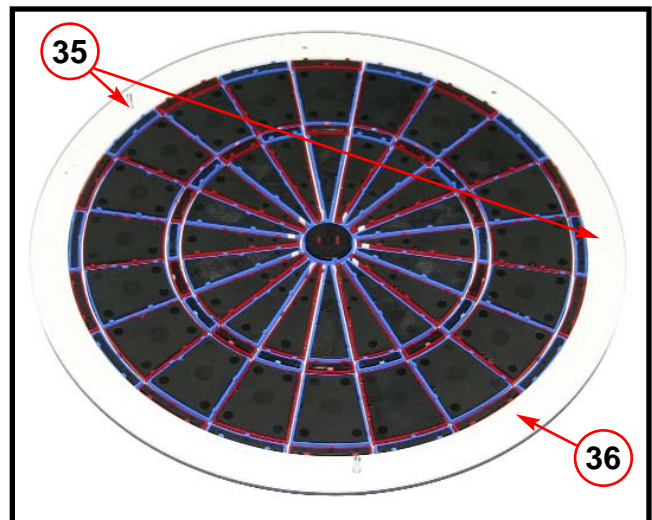

# 43374 Ground Plane Assembly [See Appendix 2]

Part#	Ref#	Description
43456	44	Power Supply
43387	45	Input/Output Board (IOB) [See Appendix 3]
43086	46	Ground Plane Bracket
43784	47	Motherboard Assembly with Ram, Processor, and Processor Fan
43148	48	PCI Card Mounting Bracket
43443	49	4 Port USB PCI Card
43797		4 Port USB Extension (Not Shown) After Serial #12129

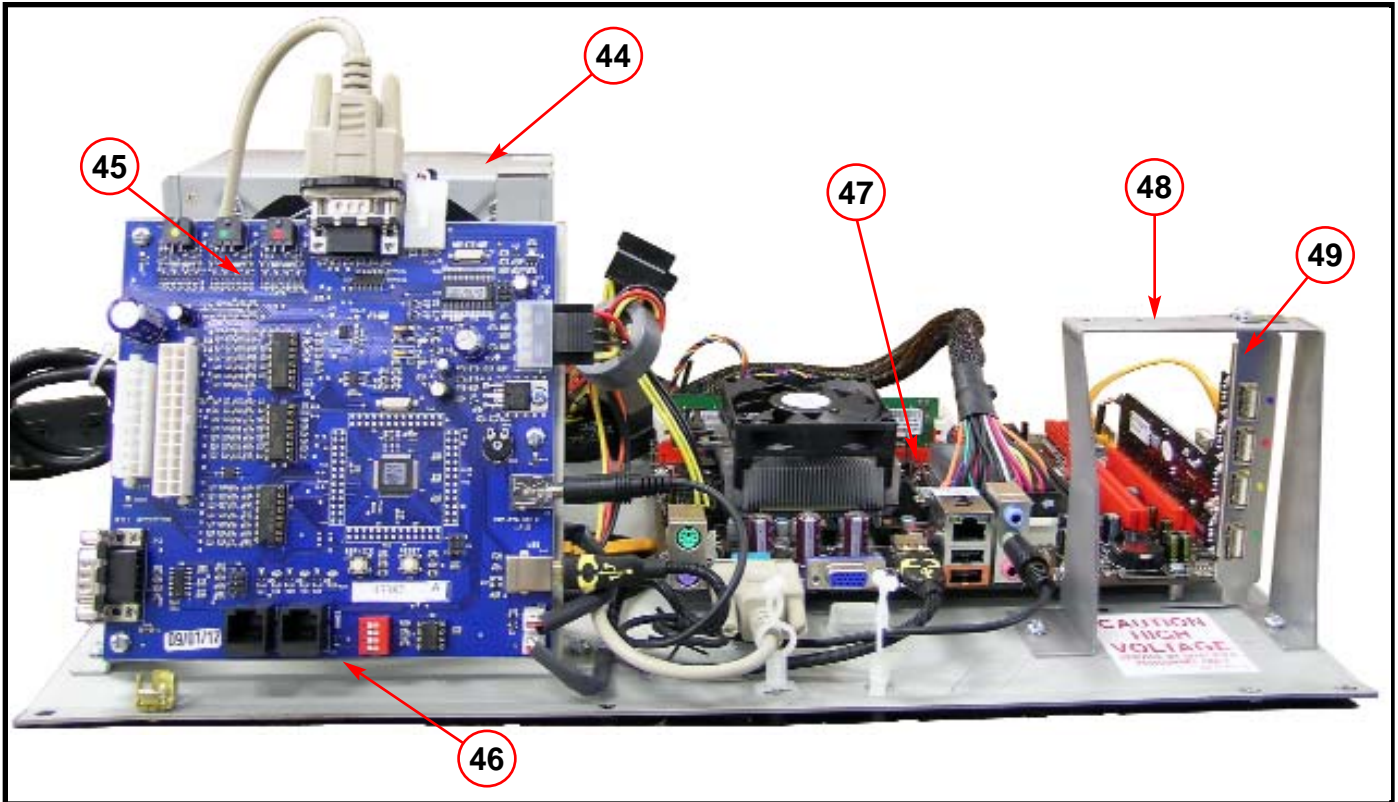

## B) 43102 USA Base Assembly 120VAC, Bill Ready

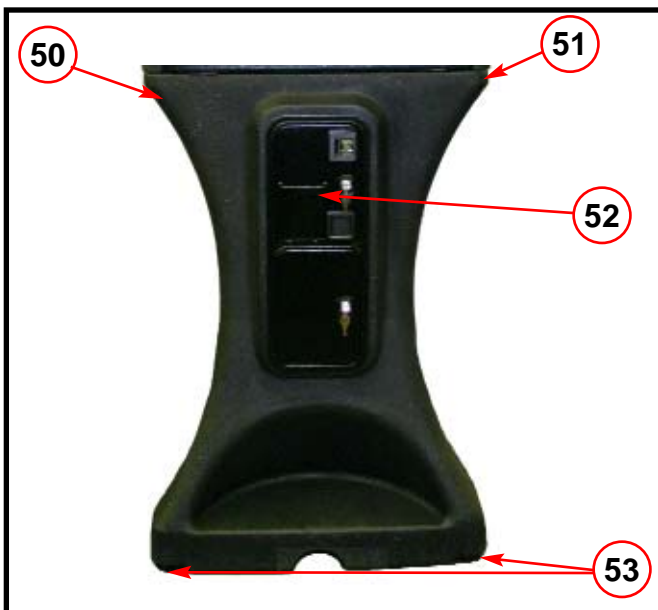

Part#	Ref#	Description
43014	50	Lower Cabinet G3
43570	51	League Chute
41883	52	Coin Door, USA, Bill Ready, Over/Under
43065	52	Coin Door Harness, USA, 120VAC, Bill Ready
42416	53	Leveler (4)



# Appendix 1

## Recommended WiFi and Dialup Modems

These are the current recommended Wifi PCI Modems for the Galaxy 3. As we test more modems this list will change.

Brand	Model	B/G/N (Communication Speed)	Note
EnGenius	EPI 360IS	G	High Powered Card
Dlink	DWA 552	N+	
Dlink	DWL G520	G	
Sabrent	PCI G802	G	
Linksys	wmp600n	N	
TP-LINK	TL-WN751ND	N	
Imicro	Int-pci	G	

Below is the list of Dialup Modems we've tested. This list may also get bigger as we test more.

*Note: Remote Play cannot be done over a Dialup Modem.*

Brand	Model	Type
Zoom	3095 USB	USB
Multitech	PCZPX MT9234ZPX-UPCI	PCI

## Appendix 2

### Ground Plane Versions and Their Galaxy 3 Serial Numbers

Part Number	Description	Galaxy 3 Serial Number
43165	120VAC IOB Has No Dip Switches	Ended at 2864
43374	120VAC IOB Has Dip Switches	Starts at 2865
43085	230VAC IOB Has No Dip Switches	Ended at 1126
43375	230VAC IOB Has Dip Switches	Starts at 1127

## Appendix 3

### IOB Versions and Their Galaxy 3 Serial Numbers

Part Number	Description	Galaxy 3 Serial Number
43299	Input/Out Board (IOB) No Dip Switches	Ended at 2864
43387	Input/Out Board (IOB) Has Dip Switches	Starts at 2865

# Appendix 4

## Troubleshooting

Here are a few troubleshooting tips and simple problems that you may run into in the field. If there is an issue you can't handle, please feel free to call Techsupport at 1-800-435-8319.

Problem	Probable Cause	Procedure
LED, Marquee and Monitor not on	<ul style="list-style-type: none"> <li>a. Is the machine plugged in?</li>   <li>b. The standby switch on the back of the machine is turned off.</li>   <li>c. Something is not connected.</li> </ul>	<ul style="list-style-type: none"> <li>a. This is a very common mistake. Make sure to check all the connections on the outside of the machine and inside. Specifically around the power supply and the outlet on the wall.</li>   <li>b. There is a toggle switch on the back of the machine near the power cord. This shuts off power to the LED's, Marquee and Monitor.</li>   <li>c. Check all connections, especially the power cables and serial cable plugged into the IOB.</li> </ul>
Game will not turn on	<ul style="list-style-type: none"> <li>a. Is the machine plugged in?</li>   <li>b. The machine itself is not getting power.</li> </ul>	<ul style="list-style-type: none"> <li>a. This is a very common mistake. Make sure to check all the connections on the outside of the machine and inside. Specifically around the power supply and the outlet on the wall.</li>   <li>b. If the solution in a doesn't work, press the red push button on the back of the machine.</li> </ul>
Remote Play Not Working	a. Various Reasons	a. See Appendix 5

# Appendix 5

## Remote Play Troubleshooting

If you are having trouble with Remote Play, run Remote Play Diagnostics by:

1. Go into the **Setup Menu**.
2. Select **Diagnostics**.
3. Select **Remote Play Diagnostics**.
4. Select **Start Test**.

This simple test will test every aspect of remote play from connection status to cameras.

Test	Possible Result	Possible Solution
Remote Play	Online or Offline	If the result is Offline this means you are unable to play remotely. One or more of the tests below has failed as well. If they are successful, it may be a server issue, give us a call.
Ranked Play	Online or Offline	If the result is Offline this means ranked play isn't working. One or more of the tests below has failed as well. If they are successful, it may be a server issue, give us a call.
Registration	Not Registered	This generally means that the machine is not listed in LeagueLeader. More specifically, the screen ID. Make sure the screen ID is in the location then Generate Files.
Server Status	FAILED	This generally means failure to connect to the internet. Could be a router or modem problem. Double check all your connections and settings. Try to Perform Update. This will give you more information on if its connecting to the internet. If possible, use a Laptop to try the internet. This should lead you in the right direction.
Connection Status	FAILED	This is another check for the internet. Follow the same trouble shooting procedure as <b>Server Status</b> .
Remote Play Enabled on LeagueLeader	FAILED	This means that the option Remote Play is not selected under the specific location in LeagueLeader. Check it then Generate files. Perform Update.
Cameras	FAILED	One or both cameras aren't working. This usually means they need to be reseated. Remove power to the machine and reseat the Orange and White USB cables on the main board. Restore power. You can also check the cameras by going into any casual mode game.
Full Access	FAILED	Not required for remote play access. Requires additional setup in the location's router. A port must be open in order to pass this test. See Full Access in manual for more help. {Required for remote leagues.}

This is, by no means, all there is to trouble shooting Remote Play. It's a good place to start. As always, if you get stuck, call our tech support line at 1-800-435-8319.

