

# NEPTUNE ELECTRONIC DARTBOARD



## Replacement Parts

Order direct at [www.gldproducts.com](http://www.gldproducts.com)  
or call our Customer Service department at  
**(800) 225-7593**  
8 am to 4:30 pm Central Standard Time

**Staple your receipt here.**

**Important:** A copy of your receipt will be needed to activate your warranty (see page 50).

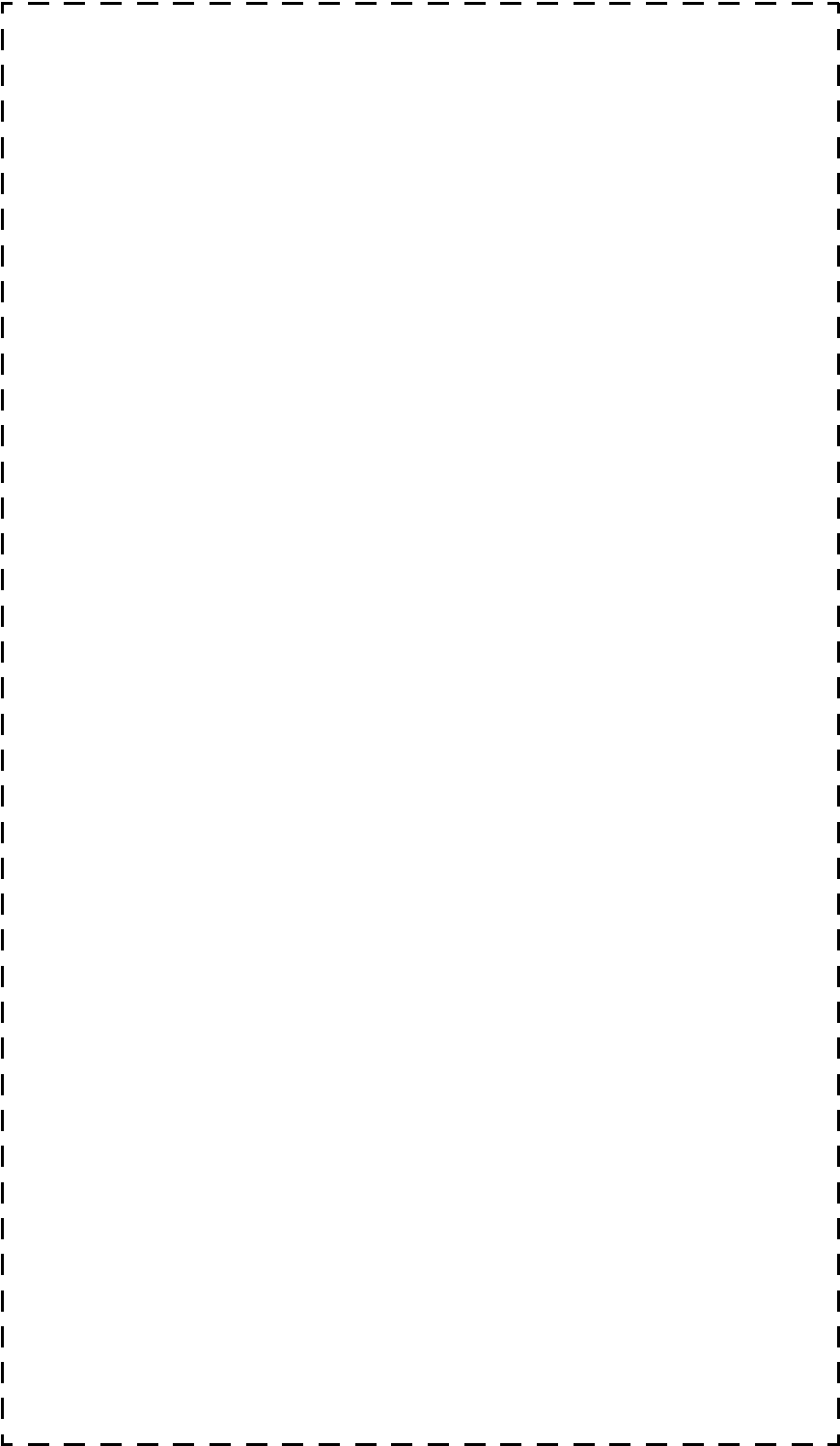



***Congratulations and THANK YOU for purchasing the Neptune Dartboard. You have chosen a product that should provide years of entertainment. To assist you with customer service and warranty claims, staple your receipt to the inside cover, then keep this manual in a safe place for future reference.***

**GLD Products**

S84 W19093 Enterprise Drive  
Muskego, WI 53150 USA  
1-800-225-7593  
Fax: 1-800-841-6944  
Email: [gld@gldmfg.com](mailto:gld@gldmfg.com)  
Web: [www.gldproducts.com](http://www.gldproducts.com)

This manual may have been updated. For the latest manual visit the GLD products website.

	<p>Place your package near the location where it will be used. Carefully unpack all components and verify you have all the correct pieces.</p> <p>If you notice missing or defective parts, please call us at: <b>1-800-225-7593</b></p>
---	--

	<p>Please read and understand all instructions before beginning assembly.</p> <p><b>This assembly will require 2 adults.</b></p>
---	--

	<p><b>Choking Hazard</b> This game has small parts that may break free and present a choking hazard. Children should be supervised by an adult when playing this game.</p>
---	--

**IF YOU HAVE A WARRANTY CLAIM, CALL US FIRST**

Please see page 50.

**GLD Products**

Available 8 am to 4:30 pm Central Standard Time

S84 W19093 Enterprise Drive

Muskego, WI 53150 USA

1-800-225-7593

Fax: 1-800-841-6944

Email: [gld@gldmfg.com](mailto:gld@gldmfg.com)

Web: [www.gldproducts.com](http://www.gldproducts.com)

For all claims, please have your receipt and item number when you call. The product item number can be found on the front cover.

**If you are instructed to return the product for service, you are responsible for shipping the unit at your expense.**

**PRODUCT REGISTRATION**

**Important: The product registration form on page 51 and a copy of your receipt must be completed and returned within 10 days of purchase to validate your warranty.**

Online registration is also available. Go to [www.gldproducts.com/index.php/registration](http://www.gldproducts.com/index.php/registration) or click on this link. Follow the online instructions.



**WARNING: Parents** - Please read instructions carefully. Not for use by children without adult supervision.

Thank you for purchasing the GLD Neptune Dartboard. The computerized scoring system makes game playing easy and enjoyable. With 57 games and 307 options to choose from, beginners and more advanced players will find challenging games to suit them.

**TOOLS REQUIRED**

- Tape measure
- Nail or marker
- Phillips screwdriver
- Level
- Mounting hardware (provided)

## UNPACKING THE GAME

After unpacking the game, it is important to save the original box, all packing material, and the receipt. These items will be needed if it ever proves necessary to return the game for service. The power adapter is located on the rear of the dartboard at the upper right hand corner.

## MOUNTING (PHYSICAL INSTALLATION)

Two methods for mounting the dartboard are available.

1. Use the two keyhole slots and mount the center of the dartboard following the illustration. The two screws are screwed into the wall until the screw head is 3/8" away from the wall. The dartboard is positioned so the two screw heads are inside the slotted keyholes. Slide the dartboard down to secure. The head of the screw that is used must be larger than 3/8" and smaller than 5/8".
2. Four equally spaced holes are accessible from the front to drive in screws. With the dartboard held in place, four screws are driven in from the front, through the existing holes. Use 1/8" diameter screws. The head of the screw must fit inside the pocket.

### Wall Anchors

A wall with studs is the most common type of wall to mount the dartboard.

1. Locate a stud and use wood screws or sheet metal type screws to secure the dartboard.
2. If a stud cannot be located or is not in the proper location, use an anchor that is suitable for the type of wall.

Some common anchors are:

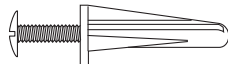

**Plastic** - Drill a snug hole in drywall and push the anchor in up to the head. When the screw is screwed into the anchor, the plastic will expand, locking the anchor in place. Do not use on thin panelling.

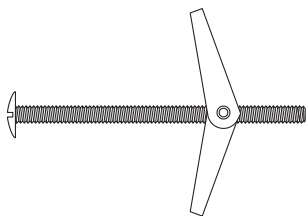

**Toggle Bolt** - Drill hole through wall. Hole must be large enough for the wings to pass through. Insert screw through the holes in the dartboard and thread the toggle wings just onto the screw. Fold the wings back and push through the hole until the wings spring open. Pull back on the screw to hold wings against the inside of the wall and tighten screw.

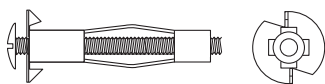

**Hollow wall anchor** - Drill a snug hole through the wall. Tap anchor into the hole until the prongs on the underside of the head are seated securely into the wall. Turn screw in and apply pressure to keep the anchor head from turning. Tighten screw until resistance is felt. Do not over tighten. Turn screw out to remove. Anchor will stay and screw can be replaced.

Other methods are available. Consult a hardware store if questions arise.

**Mounting Using the Keyhole Slots**

Refer to the illustrations on the following pages.

1. Choose a location that is near an electrical outlet and has at least 10 feet of open floor space in front of the board. Locate and use a wall stud for mounting whenever possible.
2. Determine the location for the dartboard. Place a mark on the wall 68 inches (172.7 cm) from the floor. This mark is the final position of the center of the dartboard (bullseye).
3. Locate studs and use wood screws or sheet metal screws to secure the dartboard if the mark is on the stud. The head of the screw must be larger than 3/8" and smaller than 5/8".
4. If the mark is not over a stud, use the mounting hardware that came with your dartboard.
5. Measure 8.5" (21.6 cm) directly up from the bullseye mark and place a mark on the wall. Then measure down 10.5" (26.7 cm) from the bullseye mark and place a mark on the wall. Use a level to check that all marks are vertical.
6. Drill pilot holes at the two marks. These are for the mounting screws.
7. If using wall anchors, follow the instructions under *Wall Anchors* on page 5.
8. Drive the screws in until a 1/4" (6.5 mm) gap is left between the wall and the screw head.
9. Hold the dartboard so the two screw heads fit into the lower part of the keyholes. The dartboard should slide down 1/2 inch and the screw heads will hold it on the wall.
10. Screws can be tightened or loosened to provide a secure mounting.

**Mounting Using the Four Holes From the Front**

Refer to the illustrations on the following pages.

1. Choose a location that is near an electrical outlet and has at least 10 feet of open floor space in front of the board. Locate and use a wall stud for mounting whenever possible.
2. Two people are needed for this step. Hold board on the wall. Position center of bullseye 68" from the floor. Level the board. Hold in place.
3. Locate the four mounting holes on the front of the board. Use a marker or nail to mark the position of the board through the four mounting holes onto the wall. Remove the board.
4. Drill four pilot holes on the marks created in Step 3.
5. If using plastic anchors: drill the holes so the anchors fit snugly. Push anchors into place.
6. Line up dartboard over the anchors. Screw board into place. The screws will expand the anchors.
7. After the board is mounted, the bullseye should be 68" (173 cm) above the floor.

**Create the Toe Line**

1. Place a toe line 96" from the face of the board for the throwing distance. Adhesive tape or masking tape, 2' long by 2-1/2" wide, may be used. GLD Products offers a Viper Throwing Line and a Dart Mat for this purpose. Refer to the Parts Order form (page 53) at the back of this manual.

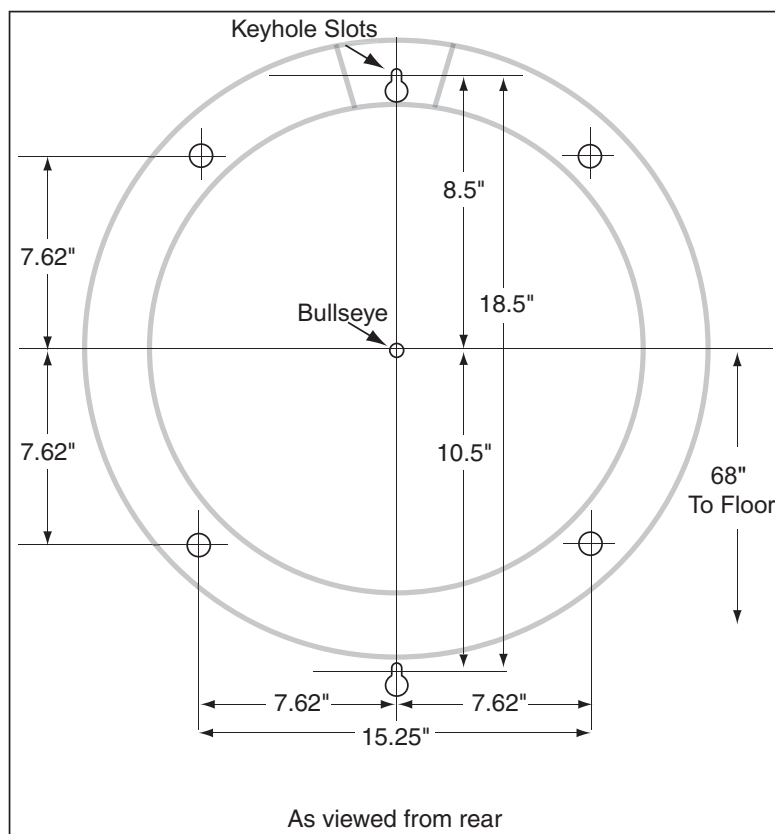
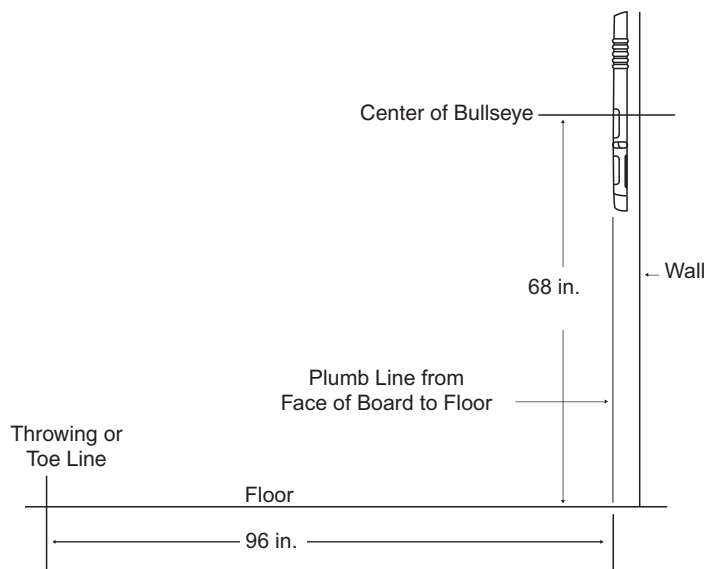

**HANDLE INSTALLATION**

This dartboard comes with handles for the doors. Use the pre-drilled holes to attach the handles. You may need to use a pointed object like a pen to push through the holes from the front of the door to open the hole all the way. Use the supplied screws to secure the handles to the front of the doors.

**POWER INSTALLATION**

The AC adapter is located on the rear of the dartboard at the upper right hand corner. The dartboard is designed to be powered by an AC to 5V DC, 500 milliamp (minimum) adapter, with the DC plug polarity configured as positive (+) outside, and negative (-) inside. To connect the adapter, plug the DC plug into the DC power jack on the dartboard and the AC plug into an electrical outlet.

1. The board is not intended for children under the age of 12 years old.
2. The board must only be used with the recommended transformer.
3. The transformer is not a toy.
4. Disconnect the dartboard from the transformer before cleaning.

**PROTECTIVE FILM**

This electronic dartboard has a clear protective film over the entire display and button area to prevent scratching during shipping. It is recommended that you remove this film for easier reading of the display. To remove, simply lift edge, peel off and discard.

**WARNING:**

Not for use by children without adult supervision. Darts are not toys and may cause injury if used improperly. Everyone must stand behind the dart thrower.



**IMPORTANT NOTES**

1. During shipping or in the course of normal play, it is possible for scoring segments of this board to become temporarily jammed, resulting in a “frozen” board. If this occurs, the built-in **Self Diagnostic Function** of the e-BOARD Computer will be activated automatically. Your dartboard will run a self-test routine to determine which segment is stuck. An error message will flash on the display together with the number for the “Frozen” segment.

**Error Code****Malfunction**

Err 40	Stuck Game Button
Err 39	Stuck Player Button
Err 38	Stuck Option Button
Err 36	Stuck Double/Auto Change Button
Err 45	Stuck Computer Button
Err 34	Stuck Bounce/301 Button
Err 35	Stuck Eliminate/Cricket Button
Err 37	Stuck Miss/Count Up Button
Err 33	Stuck Sound/Bull Button
Err 32	Stuck Play/Next Button
Err XX	A segment is stuck, the XX indicates the number of the segment, (a D at the end indicates Double, a T at the end indicates Triple).

Take the following steps immediately when the error message appears.

- a. Find the “frozen” segment according to the display.
  - b. Press firmly down on the “frozen” segment until it breaks free and the loose fit is restored. Once the “frozen” segments are loosened, the error message should be gone and the board will continue to operate normally.
2. This game is designed for use with 3/4" length soft-tip darts only! Never use metal tipped darts or longer soft-tip darts on this dartboard! Metal tipped darts will seriously damage the circuitry, the e-BOARD computer, and electronic operation of the dartboard.
  3. Electronic and mechanical reaction time is required between shots. If two shots occur too close together, pull out second dart and rethrow to properly record your score.
  4. Use only the provided AC adapter. **Using the wrong adapter may cause electrical shock and damage to the unit.**
  5. Do not use excessive force when throwing darts. Throwing a dart too hard will cause frequent tip breakage and cause excessive wear on the board.
  6. Do not spill liquids on the dartboard. Do not use spray cleaners that contain ammonia or other harsh chemicals, as they may damage the dartboard. Instead, we suggest regular dusting with a damp cloth. Make sure the game is unplugged and use a mild detergent and a damp cloth for more vigorous cleaning.
  7. This game is for indoor use only.

Helpful Tip: To prevent dart tips from loosening, twist the dart to the right (clockwise) when pulling it from the board. This motion will make dart removal easier and will prolong the life of your dart tips.

**GAME OPERATIONS**

<b>Segment</b>	<b>Scoring</b>	<b>Scoring Rules</b>
Single scoring segment		score times 1
Double scoring segment		score times 2
Triple scoring segment		score times 3
Outer bullseye		25 times 1
Center bullseye		25 times 2

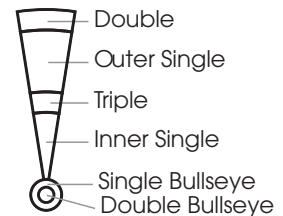
**QUICK START - IF YOU JUST WANT TO START THROWING DARTS**

1. Turn game on by pressing the ON/OFF button.
2. Press the GAME button once.

**NOTE:** The default game is G01 301 Count Down with 4 players, and double bull.

3. Press the PLAY/NEXT button.
4. Take turns throwing darts. When a players score reaches exactly 0 they are the winner.

**NEPTUNE GAME MENU**

<b>Game Number</b>	<b>Name</b>	<b>Options</b>	<b>Players</b>
G01	301	6	1-16
G01	501	6	1-16
G01	601	6	1-16
G01	701	6	1-16
G01	801	6	1-16
G01	901	6	1-16
G02	301 League	6	4
G02	501 League	6	4
G02	601 League	6	4
G02	701 League	6	4
G02	801 League	6	4
G02	901 League	6	4
G03	Quick Cricket	5	1-16
G04	American Cricket	5	1-16
G05	Cut Throat Cricket	5	1-16
G06	Scram Cricket	2	2
G07	Double Only Cricket	5	1-16
G08	Random Cricket	2	1-16
G09	Minnesota Cricket Simple	2	1-16
G10	Minnesota Cricket Standard	2	1-16
G11	Spanish Cricket	5	1-16
G12	Shanghai	14	1-16
G13	Count Up 100	2	1-16
G13	Count Up 200	2	1-16
G13	Count Up 300	2	1-16
G13	Count Up 400	2	1-16
G13	Count Up 500	2	1-16
G13	Count Up 600	2	1-16
G13	Count Up 700	2	1-16
G13	Count Up 800	2	1-16
G13	Count Up 900	2	1-16
G14	Shoot Out	12	1-16

<b>Game Number</b>	<b>Name</b>	<b>Options</b>	<b>Players</b>
G15	Best of Nine	9	1-16
G16	Call Three	10	1-16
G17	Poker Darts	4	1-16
G18	Hound and Hare	7	2
G19	Halve-It	2	1-16
G20	Gold Hunting	8	1-16
G21	Killer	13	2-16
G22	Blind Killer	12	2-16
G23	Round-The-Clock	6	1-16
G24	Round-The-Clock Double/Triple	10	1-16
G25	Round-The-Clock The Irish Way	2	1-16
G26	Nine-Dart Century	5	1-16
G27	Football	1	1-16
G28	Bowling	8	1-16
G29	Golf	12	1-16
G30	Car Racing	2	1-16
G31	Big Six	7	2-16
G32	Shove A Penny	2	1-16
G33	Hi Score	12	1-16
G34	Double Down	2	1-16
G35	Forty One	2	1-16
G36	Over	5	2-16
G37	Under	5	2-16
G38	All Fives	7	1-16
G39	Legs	5	2-16
Total		307	



8. The Neptune is equipped with a Cyber Player playing feature. Players can select a Cyber Player to play in the game by pressing the COMPUTER button. Your selection will be displayed in the Player 1 scoreboard and the Cricket display. The choices for cyber player are as follows:

Cyber player Skill Level	Player 1 Display
OFF CPU	
BEGINNER	⊗ ⊗
INTERMEDIATE	⊗ ⊗ ⊗ ⊗
ADVANCED	⊗ ⊗ ⊗ ⊗ ⊗ ⊗
EXPERT	⊗ ⊗ ⊗ ⊗ ⊗ ⊗ ⊗ ⊗
PROFESSIONAL	⊗ ⊗ ⊗ ⊗ ⊗ ⊗ ⊗ ⊗ ⊗ ⊗

When the game begins the last player to throw will be announced as “Cyber Player”. The cyber player will then post three scores.

9. Press PLAY/NEXT to start a game.
10. While in a game you can change the sound level. Press the SOUND /BULL button to change the sound. When you push the button, three levels of beeps will be heard and once in the cycle no sound will be heard.
11. If a dart thrown at the board scores, but does not stick in the board, you can eliminate that score. Press the BOUNCE/301 button until the score you wish to eliminate flashes. Then eliminate this score by pressing the ELIMINATE/CRICKET button.
12. If a dart thrown at the dartboard doesn't hit the scoring segments you can push the MISS button.
13. This dartboard is equipped with at standby and automatic shut off as a power saving feature. If the dartboard is untouched for 5 minutes it will go into a standby mode. Push any button to return to what you were doing. If untouched for long enough it will automatically shut off.
14. During a game you can push the DOUBLE/AUTO CHANGE button to activate the Automatic Player Change feature. There is no indication on the board that this is activated or not. If it is activated the game will change to the next player after a turn is over automatically after 10 seconds. If this is not activated you must push the PLAY/NEXT button after your turn has ended to switch to the next player.
15. When a player finishes the game first, the game will announce “winner” and the celebration and applause will be heard.
16. To turn the dartboard off, press and hold the ON/OFF button

**NEPTUNE GAME DESCRIPTIONS & RULES**

**G01 301 (with scoring options of 301, 501, 601, 701, 801, 901)**

**Game Options:**

- Single In/Single Out
- Double In/Single Out
- Double In/Double Out
- Single In/Double Out
- Double Bull
- Single Bull

Your scoring options are the starting score for the game, see the chart below. Press GAME OPTIONS button to select.

<b>Scoring Options</b>	301	501	601	701	801	901
<b>Starting Score</b>	301	501	601	701	801	901

Refer to the section “Read First - Operation”.

**Playing the Game**

To win: The first player who reaches exactly zero wins.

- The starting score for each player is 301 (or 501/601/701/801/901) as selected before starting the game.
- The score will be deducted for each dart that scores.
- You must go out with the exact number. If you go over zero the dartboard will announce “TOO HIGH, NEXT PLAYER”.
- For **Single In** or **Single Out** options, the game can be started or ended by throwing at any segment, regardless if single, double or triple.
- If you selected **Double In**, you must hit a double segment or bullseye to start the game. If you selected **Double Out** you must hit a double segment or bullseye to end the game.
- If **Double Out** has been selected, the Dart Out feature is automatically activated. In this mode, once a player is 170 or below, the e-BOARD Computer will suggest the 3 best possible finishing shots, or if an OUT is not possible, the best remaining alternative shots are displayed.

**G02 301 League (with scoring options 301, 501, 601, 701, 801, 901)**

**Game Options:**

- Single In/Single Out
- Double In/Single Out
- Double In/Double Out
- Single In/Double Out
- Double Bull
- Single Bull

Your scoring options are the starting score for the game, see the chart below. Press GAME OPTIONS button to select.

<b>Scoring Options</b>	301	501	601	701	801	901
<b>Starting Score</b>	301	501	601	701	801	901

Refer to the section “Read First - Operation”.

**Playing the Game**

To win: The team will win when one player’s score reaches exactly zero, and his teammates score is lower than or equal to the sum of the score of the opposing team.

- This game is played by 2 teams who compete with each other. Each team has 2 members. Team 1 is made up of player 1 and Player 3. Team 2 is made up of Player 2 and Player 4.
- The team will win when one player’s score reaches exactly zero, and his teammates score is lower than or equal to the sum of the score of the opposing team. Otherwise the score of the current player returns to the beginning of the turn. That team cannot win at that time.
- Once a players score is at 181 for **Single Out**, or at 171 or below for **Double Out** and their teammates score is lower than or equal to the the sum of the score of the opposing team, the dartboard will announce “GO FOR OUT”. This will confirm you have a chance to win in this round. If you have not met these conditions the dartboard will announce “FREEZE” even if their score comes to zero.
- The same **Single In/Out** and **Double In/Out** rules from game G01 301 apply.



**G03 Quick Cricket (with scoring options of 000, 020, 025)**

**Game Options:**

Double Bull

Single Bull

The scoring options are described in the chart below. Press GAME OPTIONS button to select.





Scoring Options	Description
000	Hit and open numbers 15-20 and bullseye in any order.
020	Hit and open the number 20 first, then in order, open numbers 19, 18, 17, 16, 15 and bullseye.
025	Hit and open bullseye first, then in order, open numbers 15, 16, 17, 18, 19 and 20.

Refer to the section “Read First - Operation”.

**Playing the Game**

To win: The first player to hit each number 3 times and open them all is the winner.

**NOTE:** A single segment counts as one hit, a double segment counts as two hits and a triple segment counts as three hits.

Cricket Status	One Time	Two Times	Open	Close
Sign				

- In Quick Cricket only the numbers 15-20 and bullseye are used. The first player to hit each number 3 times and open them all is the winner.
- If every player has opened a number, that number will then close.

**NOTE:** All valid hits will be confirmed and displayed by the Cricket Display.

**G04 American Cricket (with scoring options of C00, C20, C25)**

**Game Options:**

Double Bull

Single Bull

The scoring options are described in the chart below. Press GAME OPTIONS button to select.





Scoring Options	Description
C00	Hit and open numbers 15-20 and bullseye in any order.
C20	Hit and open the number 20 first, then in order, open numbers 19, 18, 17, 16, 15 and bullseye.
C25	Hit and open bullseye first, then in order, open numbers 15, 16, 17, 18, 19 and 20.

Refer to the section “Read First - Operation”.

**Playing the Game**

To win: A player wins the game when he first opens all the numbers and has an equal or greater score than the other players. However, if players are tied on points, or have no points, the first player to open all numbers wins.

**NOTE:** A single segment counts as one hit, a double segment counts as two hits and a triple segment counts as three hits.

Cricket Status	One Time	Two Times	Open	Close
Sign				

- In Cricket only the numbers 15-20 and bullseye are used.
- All valid hits will be confirmed and displayed by the Cricket Display.
- When a number has been hit 3 times by a player, it is then open to that player and any further hits by that player will score points.
- Once a number has been hit 3 times by all the players, that number is then closed and can no longer be scored upon by any player. At that time the indicator will change to closed for that number.
- A player who has opened a number can continue to score on that number until it becomes closed.
  - If a player has opened all numbers first, but is behind on points, scoring continues on open numbers. If that player has not accumulated the highest point total by the time another player opens all their numbers, the player with the most points will be the winner.

**G05 Cut Throat Cricket (with scoring options of 00C, 20C, 25C)**

**Game Options:**

Double Bull

Single Bull

The scoring options are described in the chart below. Press GAME OPTIONS button to select.





Scoring Options	Description
00C	Hit and open numbers 15-20 and bullseye in any order.
20C	Hit and open the number 20 first, then in order, open numbers 19, 18, 17, 16, 15 and bullseye.
25C	Hit and open bullseye first, then in order, open numbers 15, 16, 17, 18, 19 and 20.

Refer to the section “Read First - Operation”.

**Playing the Game**

To win: The player who first opens all numbers and has the lower score wins.

**NOTE:** A single segment counts as one hit, a double segment counts as two hits and a triple segment counts as three hits.

Cricket Status	One Time	Two Times	Open	Close
Sign				

- In Cricket only the numbers 15-20 and bullseye are used.
- If every player has opened a number, that number will then close.
- All valid hits will be confirmed and displayed by the Cricket Display.
- Once the scoring begins, points are added to your opponents scores who haven't opened that number.

**G06 Scram Cricket**

**Game Options:**

Double Bull



Single Bull

Refer to the section “Read First - Operation”.

**Playing the Game**

To win: During round 2, if Player 1’s score goes over Player 2’s score the game will end and Player 1 will be the winner. If Player 2 closes all the numbers and has a higher score than Player 1, Player 2 will be the winner.

**NOTE:** A single segment counts as one hit, a double segment counts as two hits and a triple segment counts as three hits.

Cricket Status	One Time	Two Times	Open	Close
Sign	\	X		

- All valid hits will be confirmed and displayed by the Cricket Display.
- This game is a variation of Cricket.
- The game consists of 2 rounds. In the first round, player 1 must close 15 through 20 and bullseye while player 2 attempts to get as high a score as he can by scoring on the open numbers. Round 1 will be finished when all numbers have been closed. For round 2, the reverse is done.
- During round 2, if Player 1’s score goes over Player 2’s score the game will end and Player 1 will be the winner. If Player 2 closes all the numbers and has a higher score than Player 1, Player 2 will be the winner.

**G07 Double Only Cricket (with scoring options of C00, C20, C25)**

**Game Options:**

Double Bull

Single Bull

The scoring options are described in the chart below. Press GAME OPTIONS button to select.



Scoring Options	Description
C00	Hit and open numbers 15-20 and bullseye in any order.
C20	Hit and open the number 20 first, then in order, open numbers 19, 18, 17, 16, 15 and bullseye.
C25	Hit and open bullseye first, then in order, open numbers 15, 16, 17, 18, 19 and 20.

Refer to the section “Read First - Operation”.

**Playing the Game**

To win: A player wins the game when he first opens all the numbers and has an equal or greater score than the other players. However, if players are tied on points, or have no points, the first player to open all numbers wins.

**NOTE:** A single segment counts as one hit, a double segment counts as two hits and a triple segment counts as three hits.

Cricket Status	One Time	Two Times	Open	Close
Sign	\	X		

- All valid hits will be confirmed and displayed by the Cricket Display.
- You have to hit a double segment for each number first, in order for hits or scoring to be possible.
- For example, to start with the number 20, you must hit the double 20 segment. Any hits before you do this will count as a miss. Once you’ve hit your double 20 you have three possibilities for that number:
  - If you hit a single 20 it will open the 20 for scoring.
  - If you hit a double 20 it will open the 20 for scoring and score you 20 points.
  - If you hit a triple 20 it will open the 20 for scoring and score you 40 points.
- Players that have opened a number may continue to score on it until it is closed.
- Once all players have opened a number that number will close and no one can score on it anymore.

**G08 Random Cricket**

**Game Options:**

Double Bull



Single Bull

Refer to the section “Read First - Operation”.

**Playing the Game**

To win: The first player to open all the selected numbers and the bullseye and have the highest score wins.

**NOTE:** A single segment counts as one hit, a double segment counts as two hits and a triple segment counts as three hits.

Cricket Status	One Time	Two Times	Open	Close
Sign	\	X		

- If every player has opened a number, that number will then close.
- All valid hits will be confirmed and displayed by the Cricket Display.
- The e-Board Computer will randomly select numbers for you to hit. The random numbers will alternate on the display. Once a player hits one of the designated random numbers it will become locked in for all players for the rest of the game.
- The seventh number in every game is the bullseye.
- Numbers can be hit in any order.
- Once a players turn is over, the numbers that have not been hit, up to this point, will change to a different random number.
- The numbers that are locked in will stay the same.
- You have to hit each designated number three times to open it. Double segments count as two hits and triple segments count as three hits.

**G09 Minnesota Cricket Simple**

**Game Options:**

Double Bull



Single Bull

Refer to the section “Read First - Operation”.

**Playing the Game**

To win: There is no scoring. The first to close all the cricket numbers is the winner.

**NOTE:** A single segment counts as one hit, a double segment counts as two hits and a triple segment counts as three hits.

Cricket Status	One Time	Two Times	Open	Close
Sign	\	X		

- If every player has opened a number, that number will then close.
- All valid hits will be confirmed and displayed by the Cricket Display.
- Players can open 15-20, bullseye, D (Double), T (Triple) and 3B (3 singles) in any order.
- D refers to hitting any three doubles, other than the bullseye, to open the target.
- T refers to hitting any three triples to open the target.
- 3B refers to hitting three single segments, in the same number, in one turn. You have to do this in 3 separate turns to open this target.

**G10 Minnesota Cricket Standard**

**Game Options:**

Double Bull



Single Bull

Refer to the section “Read First - Operation”.

**Playing the Game**

To win: The first player to open all cricket numbers is the winner.

**NOTE:** A single segment counts as one hit, a double segment counts as two hits and a triple segment counts as three hits.

Cricket Status	One Time	Two Times	Open	Close
Sign	\	X		

- Players accumulate scores to win similar to American Cricket.
- If every player has opened a number, that number will then close.
- All valid hits will be confirmed and displayed by the Cricket Display.
- Players can open 15-20, bullseye, D (Double), T (Triple) and 3B (3 singles) in any order.
- D refers to hitting any three doubles, other than the bullseye, to open the target.
- T refers to hitting any three triples to open the target.
- 3B refers to hitting three single segments, in the same number, in one turn. You have to do this in 3 separate turns to open this target.
- A standard cricket number will open first before you can use that segment for a D, T or 3B. For example if you hit a T20 and you haven't opened the standard cricket 20 it will open the standard cricket 20 instead of giving you one hit for your T target.



**G11 Spanish Cricket (with scoring options of C00, C20, C11)**

**Game Options:**

Double Bull

Single Bull

The scoring options are described in the chart below. Press GAME OPTIONS button to select.





Scoring Options	Description
C00	Hit and open numbers 11-20 in any order.
C20	Hit and open the number 20 first, then in order, open numbers 19, 18, 17, 16, 15, 14, 13, 12 and 11.
C11	Hit and open 11 first, then in order, open numbers 12, 13, 14, 15, 16, 17, 18, 19 and 20.

Refer to the section “Read First - Operation”.

**Playing the Game**

To win: The player who opens all their numbers first and has an equal or greater score than all the other players is the winner.

**NOTE:** A single segment counts as one hit, a double segment counts as two hits and a triple segment counts as three hits.

Cricket Status	One Time	Two Times	Open	Close
Sign				

- The available numbers are 11-20. No bullseye is used for this game.
- All valid hits will be confirmed and displayed by the Cricket Display.
- When a number has been hit 3 times by a player, it is then open to that player and any further hits by that player will score points.
- Once a number has been hit 3 times by all the players, that number is then closed and can no longer be scored upon by any player. At that time the indicator will change to closed for that number.
- A player who has opened a number can continue to score on that number until it becomes closed.
- If a player has opened all numbers first, but is behind on points, scoring continues on open numbers. If that player has not accumulated the highest point total by the time another player opens all their numbers, the player with the most points will be the winner.

**G12 Shanghai (with scoring options of L01, L05, L10, L15, H01, H05, H10, H15, P01, P05, P10, P15)**

**Game Options:**

- Double Bull
- Single Bull

The scoring options are described in the chart below. Press GAME OPTIONS button to select.

Scoring Option	L01	L05	L10	L15	H01	H05	H10	H15	P01	P05	P10	P15
Game starts on number	1	5	10	15	1	5	10	15	1	5	10	15
	Can hit any segment				Must hit double or triple segments				Various doubles and triples must be hit as specified by the computer			

Refer to the section “Read First - Operation”.

**Playing the Game**

To win: The player who gets the most points at the end of the game wins.

- Each player must hit all the numbers and the bullseye in order. Games have changing start numbers.
- The target number for each turn will change by one, ending with the bullseye.
- The dartboard will display the target number you are supposed to hit.
- Throw 3 darts for each number and the player who gets the most points at the end of the game wins.
- Your score is the number of the segment you are on.
- Hitting a double segment in the number you are on will double your points, likewise a triple will triple your points. For example if you are on number 4 and you hit a single in segment 4 you get 4 points. If you are on number 4 and you hit a double segment 4 you get 8 points.

**G13 Count Up (with scoring options of 100, 200, 300, 400, 500, 600, 700, 800, 900)**

**Game Options:**

- Double Bull
- Single Bull

The scoring options are the set points which are the points needed to win, see the chart below. Press GAME OPTIONS button to select.

<b>Scoring Option</b>	100	200	300	400	500	600	700	800	900
<b>Set Points</b>	100	200	300	400	500	600	700	800	900

Refer to the section “Read First - Operation”.

**Playing the Game**

To win: The first player to reach or go over the set points will be the winner.

- Your score will be accumulated for each dart.

**G14 Shoot Out (with scoring options of -11, -12, -13, -14, -15, -16, -17, -18, -19, -20)**

**Game Options:**

- Double Bull
- Single Bull

The scoring options are the number of marks you must hit, see the chart below. Press GAME OPTIONS button to select.

<b>Scoring Option</b>	-11	-12	-13	-14	-15	-16	-17	-18	-19	-20
<b>No. of Marks</b>	11	12	13	14	15	16	17	18	19	20

Refer to the section “Read First - Operation”.

**Playing the Game**

To win: The first player who hits 11, 12, 13...20 marks, depending on the option selected, is the winner.

- The e-BOARD Computer will randomly select a number for the player to hit.
- One correct hit on the displayed number subtracts one mark.
- Single, double and triple segments all count as one hit.
- If a player does not hit the selected number within 8 seconds, the dart is regarded as a miss and the e-BOARD Computer will automatically select another random number for the player to hit for the next dart.

**G15 Best of Nine (with scoring options of 009, 012, 015, 018, 021, 024, 027)****Game Options:**

Double Bull

Single Bull

The scoring options are the number of darts thrown, matched with the number of rounds for the game, see the chart below. Press GAME OPTIONS button to select.

<b>Scoring Option</b>	009	012	015	018	021	024	027
<b>No. of Darts/Rounds</b>	9/3	12/4	15/5	18/6	21/7	24/8	27/9

Refer to the section “Read First - Operation”.

**Playing the Game**

To win: The player with the highest score at the end of the game wins.

- The dartboard will announce “PLAYER 1” and display a number for you to hit.
- The target number will change fore each turn.
- Each player will take a turn throwing three darts.
- The object is to hit your assigned number.
- For every single segment hit in your number you will get one point. For every double segment hit in your number you will get two points and for every triple segment hit in your number you will get three points.
- The cricket display will count down how many rounds you have left.

**G16 Call Three (with scoring options of r03, r04, r05, r06, r07, r08, r09, r10)****Game Options:**

Double Bull

Single Bull

The scoring options are the number of rounds played for the game, see the chart below. Press GAME OPTIONS button to select.

Scoring Option	r03	r04	r05	r06	r07	r08	r09	r10
No. of Rounds	3	4	5	6	7	8	9	10

Refer to the section “Read First - Operation”.

**Playing the Game**

To win: The player with the highest score at the end of all the rounds wins.

- The e-Board Computer will select 3 random numbers. The players must hit the numbers in the order displayed.
- Hitting the number displayed in a single segment, is worth one point. If they hit the number displayed in a double segment they get two points and if they hit the number displayed in a triple segment they get three points.
- The cricket display will count down how many rounds you have left.

**G17 Poker Darts (with scoring options of A00, d00)****Game Options:**

Double Bull

Single Bull

The scoring options for this game do not change the way the game is played.

Refer to the section “Read First - Operation”.

**Playing the Game**

To win: The first player to get rid of all their “cards” or numbers wins.

- The game uses numbers 1-13 to play. These numbers represent a deck of cards. The e-Board Computer will assign 5 numbers to a player (5 cards in a hand of poker).
- The player must hit the double segment of any of their “cards” or numbers. When you do this it will eliminate that “card” or number for you and all players that have it.
- The cricket display will keep track of how many cards you have.

**NOTE:** The first three cards are displayed in the 1st, 2nd and 3rd dart display. The Temporary Score display will show 3 numbers. The first 2 digits are the fourth card and the last digit is the fifth card.

**G18 Hound and Hare (with scoring options of 005, 012, 009, 014, 011)****Game Options:**

Double Bull (not used)

Single Bull (not used)

The scoring options are the number at which the Hound starts at, see the chart below. Press GAME OPTIONS button to select.

<b>Scoring Option</b>	005	012	009	014	011
<b>Number Hound Starts At</b>	5	12	9	14	11

Refer to the section “Read First - Operation”.

**Playing the Game**

To win: If the “Hound” (Player 2) hits the same double number that the “Hare” (Player 1) is trying to hit, the “Hound” wins. If the “Hare” (Player 1) makes it back around the dartboard to the double 20, the “Hare” wins.

- The “Hare” (Player 1) tries to escape from the “Hound” (Player 2) while the “Hound” tries to catch the “Hare”.
- The “Hare” (Player 1), starts at the double 20.
- The dartboard will display what number you must hit.
- Only the double segments are used in this game.
- The “Hare” (Player 1) must hit the double 20 to move clockwise to the next number. The “Hound” (Player 2) will start at the double 5 (or 12, 9, 14, 11) segment. The “Hound” (Player 2) must hit the double 5 (or 12, 9, 14, 11) segment to move clockwise to the next number.
- The players continue to take turns throwing darts and moving around the dartboard.
- The object is for the “Hound” to catch up to the “Hare”.

**G19 Halve-It****Game Options:**

Double Bull

Single Bull

There are seven rounds of three darts each in this game. Each round has a target number you must hit to score points. The dartboard will display the number you need to hit for that round. The target numbers for each round are:

Round	1	2	3	4	5	6	7
Target Number	20	16	Double 7	14	Triple 10	17	Bullseye

Refer to the section “Read First - Operation”.

**Playing the Game**

To win: The player with the highest score after all seven rounds wins.

- Players take turns throwing darts and attempting to score points.
- If you hit the target number for that round, you will get that number in points. Double segments will double your points and triple segments will triple your points. For example, in Round 1 you have to hit the number 20. If you hit it in a single segment you will get 20 points. If you hit the double 20 you will get 40 points and the triple 20 will give you 60 points.
- For Round 3 you can only score off the double 7 segment.
- For round 5 you can only score off the triple 10 segment and for Round 7 you can only score by hitting the bullseye.
- If a player misses the designated number on all three darts in a round, their total score is cut in half.

**G20 Gold Hunting (with scoring options of 006, 009, 012, 015, 018, 021)****Game Options:**

Double Bull

Single Bull

The scoring options are the number of times you must find gold to win, see the chart below. Press GAME OPTIONS button to select.

Scoring Option	006	009	012	015	018	021
No. of Times Finding Gold	6	9	12	15	18	21

Refer to the section “Read First - Operation”.

**Playing the Game**

To win: The player who “Finds Gold” the designated amount of times first will win the game.

- The object of the game is to “Find Gold”. You will “Find Gold” whenever your score reaches exactly 50 or a multiple of 50 (100, 150, 200 etc.).
- The cricket display will keep track of how many times you find gold.
- The player who “Finds Gold” the designated amount of times first will win the game. However since gold can make you greedy, whenever you “Find Gold” you will also steal 1 gold from every player who has gold.
- To score and attempt to “Find Gold” players take turns throwing darts at the dartboard. The number on the dartboard that you hit will be your score.
- A double segment is worth double points and a triple is worth triple points.



**G21 Killer (with scoring options of -7, -8, -9, -10, -11, -12, -13, =3, =5, =7, =9)**

**Game Options:**

Double Bull

Single Bull

The scoring options are the number of lives you have and what segments to hit for a kill, see the chart below. Press GAME OPTIONS button to select.

<b>Scoring Option</b>	-7	-8	-9	-10	-11	-12	-13	=3	=5	=7	=9
<b>No. of Lives</b>	7	8	9	10	11	12	13	3	5	7	9
	Hit Single, Double or Triple to kill							Must hit Doubles only to kill			

Refer to the section “Read First - Operation”.

**Playing the Game**

To win: The last player with “Lives” will be the winner.

- To start this game, players throw a dart at the dartboard to select their number.
- The dartboard display will show SEL. Select your number by throwing a dart at the dartboard. The number selected will be used for that player throughout the game. The number you select will display in your players score display. No two players can select the same number in one game.
- To become a “Killer”, a player must hit the double segment in their selected number.
- Once you become a “Killer” your score display will show - - - during your turn. It will switch back to your selected number during other players turns.
- Once you become a “Killer” you can then kill other players by hitting the segments of the number they picked until all their “Lives” are killed. Each hit can only “Kill” one “Life” regardless if it is a double or triple.
- The number of “Lives” remaining will be displayed on the player’s cricket display.

**NOTE:** For scoring options =3, =5, =7, and =9 you can only kill if you hit a double. A single or triple count as a miss.

**G22 Blind Killer (with scoring options of L03, L04, L05, L06, L07, b03, b04, b05, b06, b07)**

**Game Options:**

- Double Bull
- Single Bull

The scoring options are the number of lives you have and what segments to hit for a kill, see the chart below. Press GAME OPTIONS button to select.

Scoring Option	L03	L04	L05	L06	L07	b03	b04	b05	b06	b07
No. of Lives	3	4	5	6	7	3	4	5	6	7
	Players are automatically a "Killer" when game starts					Player must hit Bullseye to become a "Killer"				

Refer to the section "Read First - Operation".

**Playing the Game**

To win: The last player with lives left is the winner.

- The dartboard will display SEL. You may select your number by throwing a dart at the dartboard. The number selected will be used for that player for the game. You must remember the number you selected, it will not be shown.
- This is your assigned number that other players must hit to "Kill" your lives. This number should be kept a secret from the other players. Players can try to "Kill" other players by hitting double segments of that player's number.
  - For the L03-L07 game options, you are automatically a "Killer" when the game starts.
  - For the b03-b07 options you must hit the bullseye to become a "Killer". The dartboard will display 000 until you become a "Killer" and then it will display - - -.
- The number of lives that players have left is kept secret along with the players assigned number. If a player loses all of their lives they are out.

**G23 Round-The-Clock (with scoring options of 105, 110, 115, 120)**

**Game Options:**

- Double Bull
- Single Bull

The scoring options are the last number that will be thrown, see the chart below. Press GAME OPTIONS button to select.

<b>Scoring Option</b>	105	110	115	120
<b>Last Number Thrown</b>	5	10	15	20

Refer to the section “Read First - Operation”.

**Playing the Game**

To win: The first player to hit all the designated numbers in order, wins.

- Players must hit numbers 1 through 5 (or 10, 15, 20) in order.
- The dartboard will display the number that must be hit.
- The number can be hit in any segment (single, double or triple).
- A player has to hit the designated number to move on to the next number.
- The scoreboard for each player will display the number of segments remaining.

**G24 Round-The-Clock Double/Triple (with scoring options of 205, 210, 215, 220, 305, 310, 315, 320)**

**Game Options:**

- Double Bull
- Single Bull

The scoring options are the last number that will be thrown and the segment that must be hit, see the chart below. Press GAME OPTIONS button to select.

<b>Scoring Option</b>	205	210	215	220	305	310	315	320
<b>Last Number Thrown</b>	5	10	15	20	5	10	15	20
	Must hit only Double segments				Must hit only Triple segments			

Refer to the section “Read First - Operation”.

**Playing the Game**

To win: The first player to hit all the designated numbers in order, wins.

- Only the double (205, 210, 215, 220) or triple (305, 310, 315, 320) segments are used to score for each number.
- Players must hit numbers 1 through 5 (or 10, 15, 20) in order.
- The dartboard will display the number that must be hit.
- A player has to hit the designated number to move on to the next number.
- The scoreboard for each player will display the number of segments remaining.

**G25 Round-The-Clock The Irish Way**

**Game Options:**

Double Bull (not used)

Single Bull (not used)

Refer to the section “Read First - Operation”.

**Playing the Game**

To win: Players must hit targets until they reach the bullseye. Then they must get two single bullseyes in the same turn or a double bullseye to win the game.

- Hit single segments of the number displayed to advance that number plus 1. On the first target, hit the single number 1 to move to number 2.
- Doubles and triples advance you the amount of the double or triple plus one. For example hitting double 1 will move you to number 3.
- Once you pass the number 10, the double and triple segments will count as a miss.
- If 10 is the target, then hitting a double 10 your next number will be the bullseye. Players must get two single bullseyes in the same turn or a double bullseye to win the game.

An example of a game played between 2 players is:

Nick	1st Dart	Next Target #	2nd Dart	Next Target #	3rd Dart	Next Target #
1st Turn	S1	2	T2	7	S7	8
2nd Turn	D8	17	S17	18	S5	18
3rd Turn	S18	19	S19	20	S20	Bull
4th Turn	S8	Bull	Single Bull	Bull	S1	Bull
5th Turn	Double Bull	WINNER!				
Marilyn	1st Dart	Next Target #	2nd Dart	Next Target #	3rd Dart	Next Target #
1st Turn	S1	2	S2	3	S3	4
2nd Turn	D4	9	S9	10	D10	Bull
3rd Turn	Single Bull	Bull	S17	Bull	D4	Bull
4th Turn	Single Bull	Bull	S19	Bull	D18	Bull

**G26 Nine-Dart Century (with scoring options of 100, 150, 200)****Game Options:**

Double Bull

Single Bull

The scoring options are the target score, see the chart below. Press GAME OPTIONS button to select.

<b>Scoring Option</b>	100	150	200
<b>Target Score</b>	100 Points	150 Points	200 Points

Refer to the section “Read First - Operation”.

**Playing the Game**

To win: The player that gets closest to the Target Score without going over is the winner.

- In this game each player has 9 darts (three turns) to score 100 (or 150, 200) points without going over, or get as close as possible.
- If you go over you are out of the game. The dart board will announce “TOO HIGH”.
- Darts that land outside the scoring area will reset your score back down to zero. Press the MISSED DART button.
- Darts that bounce out are not penalized and do not count for any points.
- The number on the dartboard that you hit will be your score.
- A double segment is worth double points and a triple is worth triple.

## G27 Football

### Game Options:

Double Bull

Refer to the section "Read First - Operation".

### Playing the Game

To win: The first player who finishes crossing their playing field is the winner.

- To start the game the dartboard will display SEL. The player will then throw a dart at the dartboard to determine their "number" or "playing field".
- Once a "playing field" is selected, you must hit the segments in order from the outside double segment of your number working your way in to the bullseye and to the opposite side to the outer double segment. See illustration and example below.
- A dart that hits a segment out of their playing field or out of order is a miss.

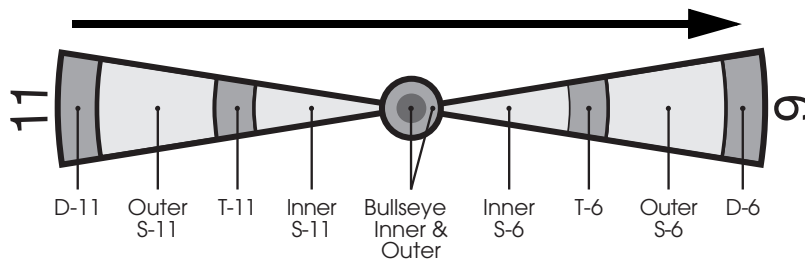

- For example, if a player selects segment 11, they have to hit D-11, outer S-11, T-11, inner S-11, outer bullseye, inner bullseye, inner S-6, T-6, outer S-6 and finally D-6.

**G28 Bowling (with scoring options of 10r, 11r, 12r, 13r, 14r, 15r)**

**Game Options:**

Double Bull (not used)

Single Bull (not used)

Before starting the game you must select the number of players and your desired scoring option. The scoring options are the number of frames, see the chart below. Press GAME OPTIONS button to select.

<b>Scoring Option</b>	10r	11r	12r	13r	14r	15r
<b>No. of Frames</b>	10	11	12	13	14	15

Refer to the section “Read First - Operation”.

**Playing the Game**

To win: The player with the highest points or “pins” at the end of the game is the winner.

- For each turn the dartboard will display SEL. For each turn your first dart will select the “Alley” and the second and third dart will score “pins” or points. Hitting the bullseye will not count as an “Alley” or give you any “pins” or points. Points are scored as follows:

<b>Segments</b>	<b>Score</b>
Double	9 Pins
Outer Single	3 Pins
Triple	10 Pins
Inner Single	7 Pins

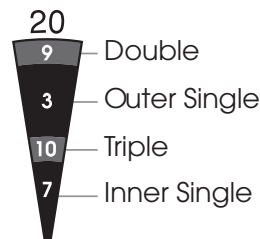

- A player cannot hit the same single segment twice in the same frame. The second hit will be counted as zero.
- You can hit the same triple or double segment twice. However hitting the double segment twice in a row will give you 10 “pins” or points. Hitting the triple segment twice will give you 20 “pins” or points.
- The cricket display will count down the number of frames left. The perfect game is 200/220/240/260/280/300 respectively for the scoring options chosen.

## G29 Golf (with scoring options of 09F, 10F, 11F, 12F, 13F, 14F, 15F, 16F, 17F, 18F)

### Game Options:

Double Bull

Single Bull

The scoring options are the number of “holes”, see the chart below. Press GAME OPTIONS button to select.

Scoring Option	09F	10F	11F	12F	13F	14F	15F	16F	17F	18F
No. of Holes	9	10	11	12	13	14	15	16	17	18

Refer to the section “Read First - Operation”.

### Playing the Game

To win: The first person to complete all their “holes” wins and the game is over.

- Numbers 1-18 are the “Holes” of the golf course and must be hit in order.
- Players must hit each number three times before they can move on to the next “hole”.
- A double will count as two hits, a triple will count as three hits.
- The e-BOARD Computer will display the best hit for the number you are on.
- Each dart thrown counts as a “stroke”, whether it hits your designated number or not, and will be displayed on the scoreboard for each player.
- The cricket display will show how many “holes” are left.
- The bullseye counts as a miss.

## G30 Car Racing

### Game Options:

Double Bull

Single Bull

Refer to the section “Read First - Operation”.

### Playing the Game

To win: The first player to finish the course is the winner.

- In this game, the dartboard becomes a race course. The course begins at the number 20 and runs clockwise around the dartboard to the number 5 triple segment and ends with the bullseye.
- You must hit the numbers in order clockwise around the dartboard. A valid hit on the course is the inner single.
- There are 4 obstacles throughout the course at the following segments: triple 13, triple 17, triple 8 and triple 5. The player must hit the triple in each of those numbers to clear the obstacle.
- The dartboard will display what segment you need to hit and each players scoreboard will display the last number hit.
- The cricket scoreboard will count down how many segments you need to finish the race.



**G31 Big Six (with scoring options of 003, 004, 005, 006, 007)****Game Options:**

Double Bull

Single Bull

The scoring options are the number of lives, see the chart below. Press GAME OPTIONS button to select.

<b>Scoring Option</b>	003	004	005	006	007
<b>No. of Lives</b>	3	4	5	6	7

Refer to the section “Read First - Operation”.

**Playing the Game**

To win: If a player loses all their lives they are out of the game. The remaining players continue the game until one player is left with lives. That player is the winner.

- This game allows a player to challenge opponents to hit the targets of the players choice. The dartboard will display the single 6 segment as the first target. Players must earn the chance to pick the next target for their opponent by making a hit on the single 6 target. If they hit the single 6, the dartboard will display SEL. They can then throw a dart to select the next target. That number and segment then becomes the target. The scoreboard will display the target. In any turn if the player does not hit the designated target they lose one life.
- If a player hits the target with the first or second dart, the next dart then determines the next target and that players turn is over.
- If a player hits the target with the third dart their turn is over and the target stays the same. A life is not lost.

## G32 Shove A Penny

### Game Options:

Double Bull



Single Bull

Refer to the section "Read First - Operation".

### Playing the Game

To win: The first player to open all their numbers is the winner.

**NOTE:** A single segment counts as one hit, a double segment counts as two hits and a triple segment counts as three hits.

Cricket Status	One Time	Two Times	Three Times
Sign			

- This game is similar to Cricket in that you must open numbers 15-20 and the bullseye in order.
- The dartboard will display which number you have to hit. You must hit each number 3 times to open it.
- Should a player score more than 3 hits in any one number, the excess hits will be given to the next player.
- The cricket display will keep track of the number of hits per number for each player.

**G33 Hi Score (with scoring options of H03, H04, H05, H06, H07, H08, H09, H10, H11, H12)****Game Options:**

Double Bull

Single Bull

The scoring options are the number of rounds, see the chart below. Press GAME OPTIONS button to select.

Scoring Option	H03	H04	H05	H06	H07	H08	H09	H10	H11	H12
No. of Rounds	3	4	5	6	7	8	9	10	11	12

Refer to the section “Read First - Operation”.

**Playing the Game**

To win: The player with the highest score at the end of all the rounds wins.

- The rules are simple. A player must rack up the most points in 3, 4, 5...or 12 rounds (each round is 3 darts) to win.
- Doubles and triples count as 2 times and 3 times that number’s score respectively.
- The cricket display will count down the remaining rounds.

**G34 Double Down****Game Options:**

Double Bull

Single Bull

Refer to the section “Read First - Operation”.

**Playing the Game**

To win: The player with the highest score after the last round is the winner.

- This game starts with a base score of 60 points for each player.
- There are 9 rounds for each player. Each round has a number or segment that you must hit in order to score.
- The dartboard will display what number you must hit for that round. The designated numbers for each round are:

Round	1	2	3	4	5	6	7	8	9
<b>Target Number</b>	15	16	Any Double	17	18	Any Triple	19	20	Bullseye

- Each dart that hits the correct number will score points based on the number and the segment. For example, if you hit number 15 single segment you will get 15 points. If you hit the number 15 double segment you would get 30 points. If you hit the number 15 triple segment you would get 45 points.
- If the player does not hit the designated number during their round their score is cut in half and they move on to the next round on their next turn.
- For the Any Double and Any Triple, the player must hit any double or triple segment. If the doubles and triples are not hit, the players score is cut in half.

## G35 Forty One

### Game Options:

Double Bull

Single Bull

Refer to the section "Read First - Operation".

### Playing the Game

To win: The player with the highest score after the last round is the winner.

- The sequence for the rounds is reversed from number 20 to the bullseye.
- There are 10 rounds for each player.
- The dartboard will display what number you must hit for that round. The designated numbers for each round are:

Round	1	2	3	4	5	6	7	8	9	10
Target Number	20	19	Any Double	18	17	Any Triple	16	15	"41" Points	Bullseye

- The additional round of 41 points is included before the bullseye, and a player must hit any 3 segments totaling 41 to score the 41 points.
- Each dart that hits the correct number will score points based on the number and the segment. For example, if you hit number 15 single segment you will get 15 points. If you hit the number 15 double segment you would get 30 points. If you hit the number 15 triple segment you would get 45 points.
- If the player does not hit the designated number during their round their score is cut in half and they move on to the next round on their next turn.
- For the Any Double and Any Triple, the player must hit any double or triple segment. If the doubles and triples are not hit, the players score is cut in half.

**G36 Over (with scoring options of O-7, O-8, O-9)****Game Options:**

Double Bull

Single Bull

The scoring options are the number of lives, see the chart below. Press GAME OPTIONS button to select.

Scoring Option	O-7	O-8	O-9
No. of Lives	7	8	9

Refer to the section “Read First - Operation”.

**Playing the Game**

To win: If a player loses all their lives they are out of the game. The remaining players continue the game until one player is left with lives. That player is the winner.

- Player 1 will throw 3 darts. Their score will become the “leader’s score” and the dartboard will announce “LEADER” and play a fanfare.
- A player’s score will become a new “leader’s score” if his score in the new turn is higher than the previous “leader’s score”. If not, he will lose one life.
- If a leader does not want to challenge and wants to keep his “leader’s score”, he can press the START GAME/NEXT PLAYER button and skip his turn. A leader can choose to challenge his own “leader’s score” but he will also lose a life if his new score is lower than the original leader’s score.
- The Cricket Display will show how many “Lives” each player has.
- The current “leader’s score” is displayed on the scoreboard.

**G37 Under (with scoring options of U-7, U-8, U-9)****Game Options:**

Double Bull

Single Bull

The scoring options are the number of lives, see the chart below. Press GAME OPTIONS button to select.

Scoring Option	U-7	U-8	U-9
No. of Lives	7	8	9

Refer to the section “Read First - Operation”.

**Playing the Game**

To win: If a player loses all their lives they are out of the game. The remaining players continue the game until one player is left with lives. That player is the winner.

- The “leader’s score” is the lowest score for each turn.
- A missed dart will be counted as 60.
- Player 1 will throw 3 darts. Their score will become the “leader’s score” and the dartboard will announce “LEADER” and play a fanfare.
- A player’s score will become a new “leader’s score” if his score in the new turn is lower than the previous “leader’s score”. If not, he will lose one life.
- If a leader does not want to challenge and wants to keep his “leader’s score”, he can press the START GAME/NEXT PLAYER button and skip his turn. A leader can choose to challenge his own “leader’s score” but he will also lose a life if his new score is higher than the original leader’s score.
- The Cricket Display will show how many “Lives” each player has.
- The current “leader’s score” is displayed on the scoreboard.

**G38 All Fives (with scoring options of 551, 561, 571, 581, 591)****Game Options:**

Double Bull

Single Bull

The scoring options are the total points you need to win, see the chart below. Press GAME OPTIONS button to select.

<b>Scoring Option</b>	551	561	571	581	591
<b>Total Points</b>	51	61	71	81	91

Refer to the section “Read First - Operation”.

**Playing the Game**

To win: The first player to score 51, 61, 71, 81, or 91 will be the winner.

- During each round the player’s total score for that round must be divisible by 5. Every divisible 5 counts as one point. For instance, 2, 8, 5 totals 15. A player will get 3 points as 15 divided by 5 equals 3. There will be no points if the round of 3 darts’ total score is not divisible by 5.
- The e-BOARD Computer will display the best possible hit for your third dart, that will give you the most points.

**G39 Legs (with scoring options of L03, L04, L05)****Game Options:**

Double Bull

Single Bull

The scoring options are the number of leg’s, see the chart below. Press GAME OPTIONS button to select.

<b>Scoring Option</b>	L03	L04	L05
<b>No. of Leg’s</b>	3	4	5

Refer to the section “Read First - Operation”.

**Playing the Game**

To win: The last player who still has a “leg” left will win

- Each player will begin with 3 (or 4, 5) “leg’s”.
- Players will take turns throwing three darts.

Each player must beat the previous players score, or they will lose a “leg”.



## ONE YEAR LIMITED WARRANTY

The Manufacturer warrants to the original retail purchaser that this product is free from defects in material and workmanship under normal use and conditions for a period of one year from the date of original purchase. The Manufacturer's liability is limited to the repair or replacement, at its option, of any defective product and shall not include any liability for indirect, incidental or consequential damages of any kind.

Should this product become defective due to material or workmanship within the warranty period, contact our Customer Service Department. This warranty is not transferable and does not cover normal wear and tear or damage caused by improper usage, negligence, misuse, abuse, transportation damage, acts of nature, or accident (including failure to follow the instructions in this manual). It does not cover expendable items such as batteries, light bulbs, fuses, accessories, cosmetic parts and other items that wear out due to normal usage. This warranty is also void if the product is disassembled and reassembled, damaged, modified from its original state, or used for other than indoor personal residential use (no commercial or rental applications).

This warranty gives you specific legal rights, and you may have other rights which vary from state to state.

### IF YOU HAVE A WARRANTY CLAIM, CALL US FIRST (8 - 4:30 CST)

Please have your receipt and item number (found on the front cover) when you call.

#### **GLD Products**

S84 W19093 Enterprise Drive

Muskego, WI 53150 USA

1-800-225-7593

Fax: 1-800-841-6944

Email: [gld@gldmfg.com](mailto:gld@gldmfg.com)

Web: [www.gldproducts.com](http://www.gldproducts.com)

**If you are instructed to return the product for service, you are responsible for shipping the unit at your expense to the above address in packaging that will protect against further damage. All warranty or repair requests require a Return Authorization Number prior to returning the item.**

### PRODUCT REGISTRATION

**Important:** The product registration form on page 51 must be completed and returned along with a copy of your receipt within 10 days of purchase to validate your warranty.

Online registration is also available. Go to [www.gldproducts.com/index.php/registration](http://www.gldproducts.com/index.php/registration) or click on this link. Follow the online instructions.

# REGISTER YOUR PRODUCT

Place postage here

Complete this form, include a copy of your receipt, fold, tape (do not staple) and return within 10 days of purchase. This protects your warranty and will help us develop new products!

Cut here.

**GLD Products**  
Warranty Department  
S84 W19093 Enterprise Drive  
Muskego, WI 53150 USA

Fold here second.



[www.gldproducts.com](http://www.gldproducts.com)

GAME TABLES	HOME CASINO
GAMES AND ACCESSORIES	BILLIARD CUES
BILLIARD ACCESSORIES	DARTBOARDS
SOFT-TIP DARTS	STEEL-TIP DARTS
FLIGHTS AND SHAFTS	DART CASES AND ACCESSORIES

Fold here first.

Name	Date of Purchase
Address	Phone-Day
City	Phone-Evening
State                      Zip	Email
Purchase Price:	Item: <b>42-1023 Neptune Dartboard</b>
Store Name:	

**Remember to attach a copy of your receipt.**

This page left intentionally blank.

**Mail To: GLD Products**  
 S84 W19093 Enterprise Drive  
 Muskego, WI 53150 USA  
 1-800-225-7593 • FAX 800-841-6944  
 Email: [gld@gldmfg.com](mailto:gld@gldmfg.com)  
 Web Site: [www.gldproducts.com](http://www.gldproducts.com)

# Neptune Dartboard

Item 42-1023

## Parts Re-Order Form

Name		Date
Address		Phone-Day
City		Phone-Evening
State	Zip	Email

Order No.	Description	Unit Price	Qty.	Total Amount
42-9988	500 mA Adapter Positive Outer	10.00		
6-44	2 Piece Bullseye, Nylon	15.00		
6-47	Pie Section, Black and Red Segments, Nylon	20.00		
6-48	Pie Section, Grey and Red Segments, Nylon	20.00		
6-15	Set of 3 Soft Tip Darts	5.00		
37-1652-01	Tips (100)	4.99		
6-38	Aluminum Shafts 3 pc	3.00		
6-11	Mounting Hardware	3.00		
6-14	Flights 3 pc	1.50		
Accessories				
37-0125	Viper Bull Throw Line	6.29		
37-0106	Viper Vinyl Dart Mat	95.99		
		Subtotal		
Shipping will be added. If paid by Check or Money Order, call for quote.		S/H		
5.1% Waukesha Wisconsin tax will apply (subject to change).		Tax		
		Total		

### Method of Payment

\_\_\_\_\_ Check or Money Order  
 \_\_\_\_\_ Credit Card

\_\_\_\_\_ Visa \_\_\_\_\_ MasterCard \_\_\_\_\_ Discover \_\_\_\_\_ American Express

Card # \_\_\_\_\_

Security Code # \_\_\_\_\_ Billing Address \_\_\_\_\_ Zip Code \_\_\_\_\_

Signature \_\_\_\_\_ Exp. Date \_\_\_\_\_

### Shipping Address

Name \_\_\_\_\_

Address \_\_\_\_\_ Phone \_\_\_\_\_

City \_\_\_\_\_ State \_\_\_\_\_ Zip \_\_\_\_\_

This page left intentionally blank.



[www.gldproducts.com](http://www.gldproducts.com)

**GAME TABLES**

**HOME CASINO**

**GAMES AND ACCESSORIES**

**BILLIARD CUES**

**BILLIARD ACCESSORIES**

**DARTBOARDS**

**SOFT-TIP DARTS**

**STEEL-TIP DARTS**

**FLIGHTS AND SHAFTS**

**DART CASES AND ACCESSORIES**



**PROUD MANUFACTURER OF**



*Yesterday's games for today's families!*  
by GLD Products

S84 W19093 Enterprise Drive • Muskego, WI 53150 USA  
262.679.8730 or 1.800.225.7593 tele  
262.679.8738 or 1.800.841.6944 fax  
Email: [gld@gldmfg.com](mailto:gld@gldmfg.com)  
[www.gldproducts.com](http://www.gldproducts.com)

**Quick Reference For Neptune Dartboard Item 42-1023**

<b>Game Number</b>	<b>Name</b>	<b>Options</b>	<b>Players</b>	<b>In/Out Single/DBL</b>	<b>Bullseye Single/DBL</b>
G01	301	6	1-16	Yes	Yes
G01	501	6	1-16	Yes	Yes
G01	601	6	1-16	Yes	Yes
G01	701	6	1-16	Yes	Yes
G01	801	6	1-16	Yes	Yes
G01	901	6	1-16	Yes	Yes
G02	301 League	6	4	Yes	Yes
G02	501 League	6	4	Yes	Yes
G02	601 League	6	4	Yes	Yes
G02	701 League	6	4	Yes	Yes
G02	801 League	6	4	Yes	Yes
G02	901 League	6	4	Yes	Yes
G03	Quick Cricket	5	1-16	N/A	Yes
G04	American Cricket	5	1-16	N/A	Yes
G05	Cut Throat Cricket	5	1-16	N/A	Yes
G06	Scram Cricket	2	2	N/A	Yes
G07	Double Only Cricket	5	1-16	N/A	Yes
G08	Random Cricket	2	1-16	N/A	Yes
G09	Minnesota Cricket Simple	2	1-16	N/A	Yes
G10	Minnesota Cricket Standard	2	1-16	N/A	Yes
G11	Spanish Cricket	5	1-16	N/A	Yes
G12	Shanghai	14	1-16	N/A	Yes
G13	Count Up 100	2	1-16	N/A	Yes
G13	Count Up 200	2	1-16	N/A	Yes
G13	Count Up 300	2	1-16	N/A	Yes
G13	Count Up 400	2	1-16	N/A	Yes
G13	Count Up 500	2	1-16	N/A	Yes
G13	Count Up 600	2	1-16	N/A	Yes
G13	Count Up 700	2	1-16	N/A	Yes
G13	Count Up 800	2	1-16	N/A	Yes
G13	Count Up 900	2	1-16	N/A	Yes
G14	Shoot Out	12	1-16	N/A	Yes
G15	Best of Nine	9	1-16	N/A	Yes
G16	Call Three	10	1-16	N/A	Yes
G17	Poker Darts	4	1-16	N/A	Yes



**Quick Reference For Neptune Dartboard Item 42-1023**

<b>Game Number</b>	<b>Name</b>	<b>Options</b>	<b>Players</b>	<b>In/Out Single/DBL</b>	<b>Bullseye Single/DBL</b>
G18	Hound and Hare	7	2	N/A	Yes
G19	Halve-It	2	1-16	N/A	Yes
G20	Gold Hunting	8	1-16	N/A	Yes
G21	Killer	13	2-16	N/A	Yes
G22	Blind Killer	12	2-16	N/A	Yes
G23	Round-The-Clock	6	1-16	N/A	Yes
G24	Round-The-Clock Double/Triple	10	1-16	N/A	Yes
G25	Round-The-Clock The Irish Way	2	1-16	N/A	Yes
G26	Nine-Dart Century	5	1-16	N/A	Yes
G27	Football	1	1-16	N/A	Yes
G28	Bowling	8	1-16	N/A	Yes
G29	Golf	12	1-16	N/A	Yes
G30	Car Racing	2	1-16	N/A	Yes
G31	Big Six	7	2-16	N/A	Yes
G32	Shove A Penny	2	1-16	N/A	Yes
G33	Hi Score	12	1-16	N/A	Yes
G34	Double Down	2	1-16	N/A	Yes
G35	Forty One	2	1-16	N/A	Yes
G36	Over	5	2-16	N/A	Yes
G37	Under	5	2-16	N/A	Yes
G38	All Fives	7	1-16	N/A	Yes
G39	Legs	5	2-16	N/A	Yes
Total		307			