

# ION LIGHT UP ELECTRONIC DARTBOARD



## Replacement Parts

Order direct at [www.gldproducts.com](http://www.gldproducts.com)  
or call our Customer Service department at  
**(800) 225-7593**  
8 am to 4:30 pm Central Standard Time

**Staple your receipt here.**

**Important:** A copy of your receipt will be needed to activate your warranty (see page 48).

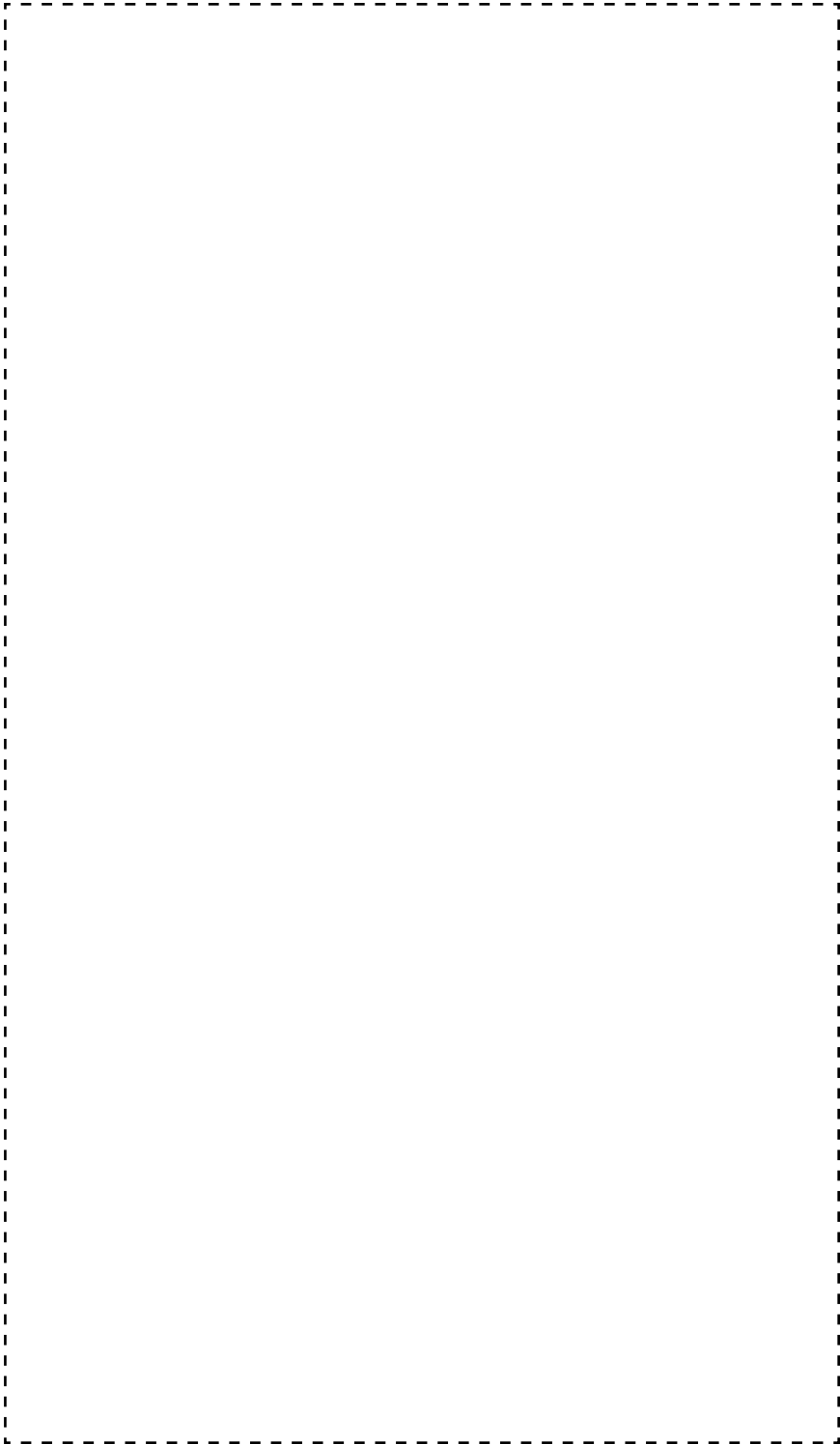



***Congratulations and THANK YOU for purchasing the Ion Light Up Dartboard. You have chosen a product that should provide years of entertainment. To assist you with customer service and warranty claims, staple your receipt to the inside cover, then keep this manual in a safe place for future reference.***

**GLD Products**

S84 W19093 Enterprise Drive  
Muskego, WI 53150 USA  
1-800-225-7593  
Fax: 1-800-841-6944  
Email: [gld@gldmfg.com](mailto:gld@gldmfg.com)  
Web: [www.gldproducts.com](http://www.gldproducts.com)

Es un Manual de Español por favor visite GLD sitio web para descargar.  
This manual may have been updated. For the latest manual or a manual in Spanish, visit the GLD products website.

	<p>Place your package near the location where it will be used. Carefully unpack all components and verify you have all the correct pieces.</p> <p>If you notice missing or defective parts, please call us at: <b>1-800-225-7593</b></p>
--	--

	<p>Please read and understand all instructions before beginning assembly.</p> <p><b>This assembly will require 2 adults.</b></p>
---	--

	<p><b>Choking Hazard</b> This game has small parts that may break free and present a choking hazard. Children should be supervised by an adult when playing this game.</p>
---	--

	<p><b>SEIZURES</b> SOME PEOPLE MAY HAVE SEIZURES TRIGGERED BY LIGHT FLASHES OR PATTERNS IN ELECTRONIC GAMES. STOP PLAYING IF YOU EXPERIENCE ALTERED VISION, MUSCLE OR EYE TWITCHING, LOSS OF AWARENESS OR DISORIENTATION.</p>
---	---

**IF YOU HAVE A WARRANTY CLAIM, CALL US FIRST:**

Please refer to page 48.

**GLD Products**

Available 8 am to 4:30 pm Central Standard Time

S84 W19093 Enterprise Drive  
Muskego, WI 53150 USA  
1-800-225-7593  
Fax: 1-800-841-6944  
Email: [gld@gldmfg.com](mailto:gld@gldmfg.com)  
Web: [www.gldproducts.com](http://www.gldproducts.com)

For all claims, please have your receipt and item number when you call. The product item number can be found on the front cover.

**If you are instructed to return the product for service, you are responsible for shipping the unit at your expense.**

**PRODUCT REGISTRATION**

**Important: The product registration form on page 49 and a copy of your receipt must be completed and returned within 10 days of purchase to validate your warranty.**

Online registration is also available. Go to <http://gldproducts.com/warranty-information> or click on this link. Follow the online instructions.



**WARNING: Parents** - Please read instructions carefully. Not for use by children without adult supervision.

Thank you for purchasing the Ion Dartboard. The computerized scoring system makes game playing easy and enjoyable. With 48 games to choose from, beginners and more advanced players will find challenging games to suit them.

**TOOLS REQUIRED**

- Tape measure
- Nail or marker
- Phillips screwdriver
- Level
- Mounting hardware (provided)

## UNPACKING THE GAME

After unpacking the game, it is important to save the original box, all packing material, and the receipt. These items will be needed if it ever proves necessary to return the game for service.

## MOUNTING (PHYSICAL INSTALLATION)

Two methods for mounting the dartboard are available.

1. Use the keyhole slots on the backside of the dartboard. Follow the illustration and mount the dartboard. The two screws are screwed into the wall until the screw head is 3/8" away from the wall. The dartboard is positioned so the two screw heads are inside the keyhole. Slide the dartboard down to secure. The head of the screw that is used must be larger than 1/4" and smaller than 3/8".
2. Four equally spaced holes are accessible from the front to drive in screws. With the dartboard held in place, four screws are driven in from the front, through the existing holes. Use 1/8" diameter screws. The head of the screw must fit inside the pocket.

### Wall Anchors

A wall with studs is the most common type of wall to mount the dartboard.

1. Locate a stud and use wood screws or sheet metal type screws to secure the dartboard.
2. If a stud cannot be located or is not in the proper location, use an anchor that is suitable for the type of wall.

Some common anchors are:

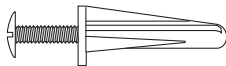

**Plastic** - Drill a snug hole in drywall and push the anchor in up to the head. When the screw is screwed into the anchor, the plastic will expand, locking the anchor in place. Do not use on thin panelling.

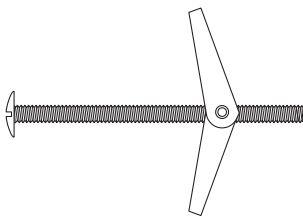

**Toggle Bolt** - Drill hole through wall. Hole must be large enough for the wings to pass through. Insert screw through the holes in the dartboard and thread the toggle wings just onto the screw. Fold the wings back and push through the hole until the wings spring open. Pull back on the screw to hold wings against the inside of the wall and tighten screw.

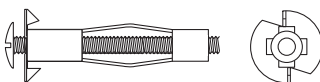

**Hollow wall anchor** - Drill a snug hole through the wall. Tap anchor into the hole until the prongs on the underside of the head are seated securely into the wall. Turn screw in and apply pressure to keep the anchor head from turning. Tighten screw until resistance is felt. Do not over tighten. Turn screw out to remove. Anchor will stay and screw can be replaced.

Other methods are available. Consult a hardware store if questions arise.

**Mounting Using the Keyhole Slots**

Refer to the illustrations on the following pages.

1. Choose a location that is near an electrical outlet and has at least 10 feet of open floor space in front of the board. Locate and use a wall stud for mounting whenever possible.
2. Locate studs and use wood screws or sheet metal screws to secure the dartboard if the mark is on the stud. The head of the screw must be smaller than 3/8" and larger than 1/4".
3. Determine the location for the dartboard. Place a mark on the wall 68 inches (172.7 cm) from the floor. This mark is the final position of the center of the dartboard (bullseye).
4. If the mark is not over a stud, use the mounting hardware that came with your dartboard.
5. Measure 8-5/8" (21.9 cm) directly up from the bullseye mark and place a mark on the wall. Then measure down 8-5/8" (21.9 cm) from the bullseye mark and place a mark on the wall. Use a level to check that all marks are vertical.
6. Drill pilot holes at the two marks. These are for the mounting screws.
7. If using wall anchors, follow the instructions under Wall Anchors on page 5.
8. Insert screws into anchors until a 1/4" (6.5 mm) gap is left between the wall and the screw head.
9. Hold the dartboard so the two screw heads fit into the lower part of the keyholes. The dartboard should slide down 1/2 inch and the screw heads will hold it on the wall.
10. Screws can be tightened or loosened to provide a secure mounting.

**Mounting Using the Four Holes From the Front**

Refer to the illustrations on the following pages.

1. Choose a location that is near an electrical outlet and has at least 10 feet of open floor space in front of the board. Locate and use a wall stud for mounting whenever possible.
2. Two people are needed for this step. Hold board on the wall. Position center of bullseye 68" from the floor. Level the board. Hold in place.
3. Locate the four mounting holes on the front of the board. Use a marker or nail to mark the position of the board through the four mounting holes onto the wall. Remove the board.
4. Drill four pilot holes on the marks created in Step 3.
5. If using plastic anchors: drill the holes so the anchors fit snugly. Push anchors into place.
6. Line up dartboard over anchors. Screw board into place. The screws will expand the anchors.

## Create the Toe Line

Place a toe line 96" from the face of the board for the throwing distance. Adhesive tape or masking tape, 2' long by 2-1/2" wide, may be used. GLD products offers a Viper Throwing Line and a Dart Mat for this purpose. Refer to the parts order form (page 51) at the back of this manual.

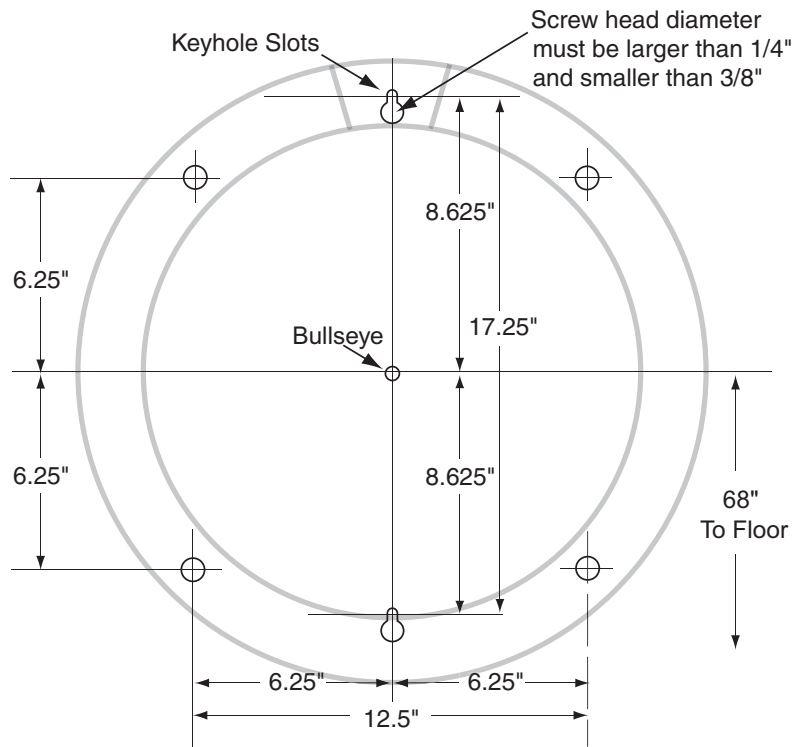
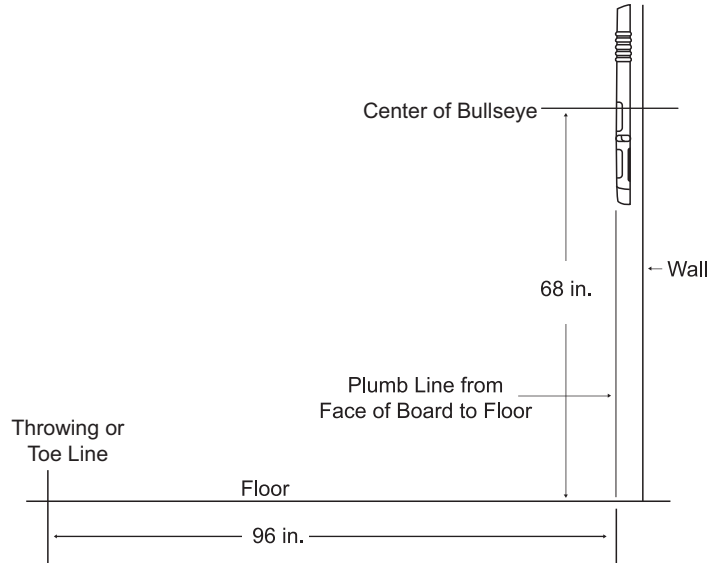

Mounting holes viewed from back

Four holes for front mounting. Use #10 screw, 5/16" max. head diameter.

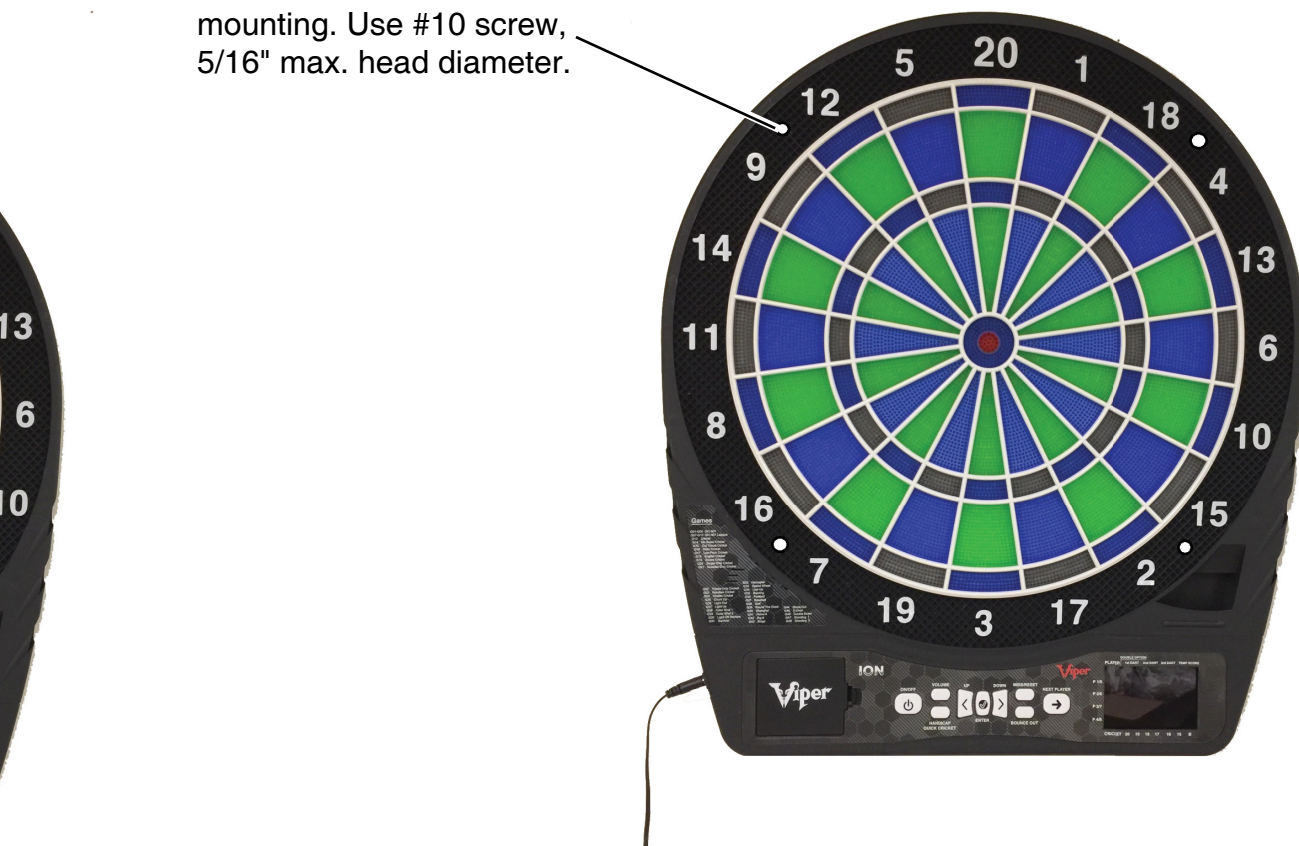

## **POWER INSTALLATION**

The dartboard is designed to be powered by 3 AA batteries (not provided) or by an AC to 5V DC, 1000 milliamp (minimum) adapter, with the DC plug polarity configured as positive (+) outside, and negative (-) center. To connect the adapter, plug the DC plug into the DC power jack on the dartboard and the AC plug into an electrical outlet.

- Always install the correct size and grade of battery suitable for the intended use.
- Replace all batteries of a set at the same time, taking care not to mix old and new ones, or batteries of different types.
- Clean the battery contacts and also those of the device prior to battery installation.
- Ensure the batteries are installed correctly with regard to polarity (+and -).
- Remove batteries from equipment which is not to be used for an extended period of time.
- Remove used batteries promptly.



If batteries are installed when the external power supply is plugged in, the dartboard turns off. To turn the dartboard back on, remove the batteries and the power cord. Plug either the power cord OR the batteries into the dartboard.



**CAUTION:** The power adapter is not a battery charging device. Do not plug in the power adapter when the dartboard is turned on.  
**Remove all the batteries before plugging in the power supply.**

1. The board is not intended for children under the age of 12 years old.
2. The board must only be used with the recommended transformer.
3. The transformer is not a toy.
4. Disconnect the dartboard from the transformer before cleaning.

## PROTECTIVE FILM

This electronic dartboard has a clear protective film over the entire display and button area to prevent scratching during shipping. It is recommended that you remove this film for easier reading of the display. To remove, simply lift edge, peel off and discard.



**WARNING: Not for use by children without adult supervision. Darts are not toys and may cause injury if used improperly. Everyone must stand behind the dart thrower.**

## IMPORTANT NOTES

1. During shipping or in the course of normal play, it is possible for scoring segments of this board to become temporarily jammed, resulting in a “frozen” board. If this occurs, the built-in **Self Diagnostic Function** of the e-BOARD Computer will be activated automatically. Your dartboard will run a self-test routine to determine which segment is stuck. An error message will flash on the display together with the number for the “Frozen” segment.
  - a. Find the “frozen” segment according to the display.
  - b. Press firmly down on the “frozen” segment until it breaks free and the loose fit is restored. Once the “frozen” segments are loosened, the error message should be gone and the board will continue to operate normally.

2. This game is designed for use with 1" maximum length soft-tip darts only! Never use metal tipped darts or longer soft-tip darts on this dartboard! Metal tipped darts will seriously damage the circuitry, the e-BOARD computer, and electronic operation of the dartboard.
3. Electronic and mechanical reaction time is required between shots. If two shots occur too close together, pull out second dart and rethrow to properly record your score.
4. If using an AC adapter, it must be 5V DC 1000 milliamp. The plug polarity is configured as positive (+) outside, and negative (-) center. **Using the wrong adapter may cause electrical shock and damage to the unit.**
5. Do not use excessive force when throwing darts. Throwing a dart too hard will cause frequent tip breakage and cause excessive wear on the board.
6. Do not spill liquids on the dartboard. Do not use spray cleaners that contain ammonia or other harsh chemicals, as they may damage the dartboard. Instead, we suggest regular dusting with a damp cloth. Make sure the game is unplugged and use a mild detergent and a damp cloth for more vigorous cleaning.
7. This game is for indoor use only.

**Helpful Tip:** To prevent dart tips from loosening, twist the dart to the right (clockwise when pulling it from the board). This motion will make dart removal easier and will prolong the life of your dart tips.

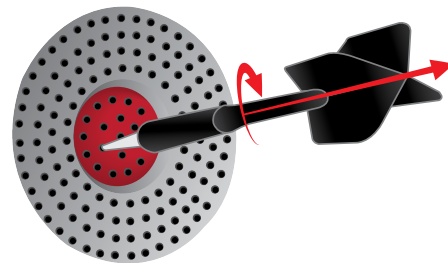

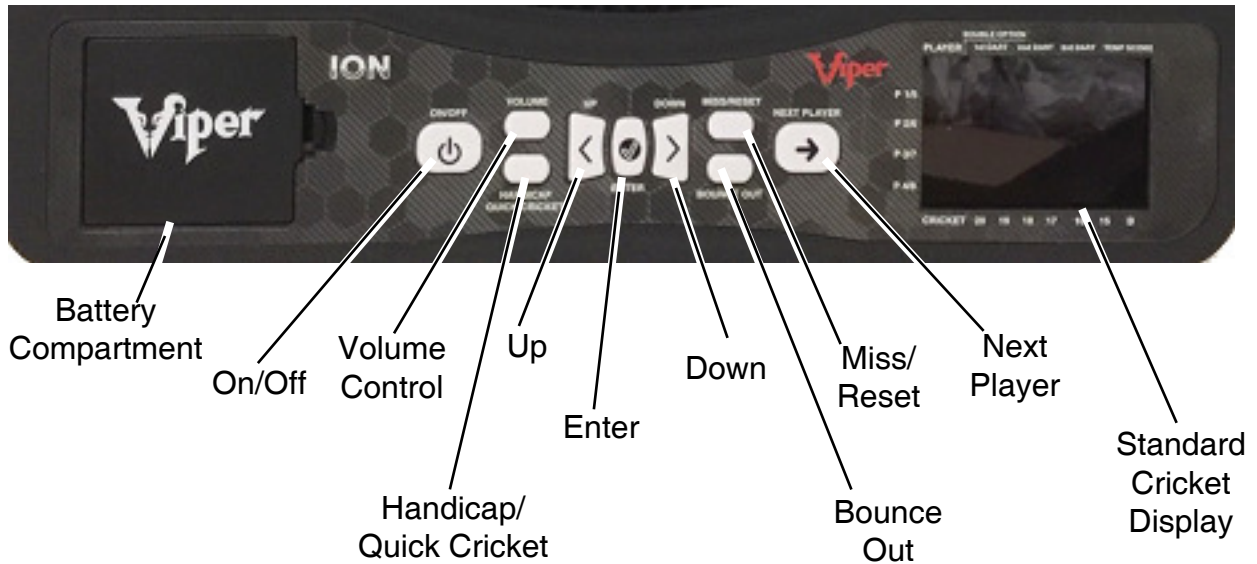

**Segment Scoring**

- Single scoring segment
- Double scoring segment
- Triple scoring segment
- Outer bullseye
- Center bullseye

**Scoring Rules**

- score times 1
- score times 2
- score times 3
- 25 times 1
- 25 times 2

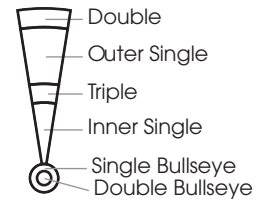

**QUICK START - IF YOU JUST WANT TO START THROWING DARTS**

1. Turn game on by pressing the ON/OFF button.
  2. Press the HANDICAP/QUICK CRICKET button.
- Note:** The default game is G13 Cricket with 1 player, and single bull.
3. Press the ENTER button. This will select G13 with option COO.
  4. Press the ENTER button again to get to number of players. 1P (single player) is displayed.
  5. Use the UP or DOWN buttons if you would like to change the number of players.
  6. Press the ENTER button and single bull will be displayed.
  7. Press the ENTER button to start the game.
  8. Take turns throwing darts. When a players score reaches exactly 0 they are the winner.

**DARTBOARD GAME MENU**

<b>Game</b>	<b>Name</b>	<b>Display</b>	<b>No. of player</b>	<b>No. of options</b>
G01	301	301	1-8	6/12
G02	501	501	1-8	6/12
G03	601	601	1-8	6/12
G04	701	701	1-8	6/12
G05	801	801	1-8	6/12
G06	901	901	1-8	6/12
G07	301 League	C31	2-8	6/12
G08	501 League	C51	2-8	6/12
G09	601 League	C61	2-8	6/12
G10	701 League	C71	2-8	6/12
G11	801 League	C81	2-8	6/12
G12	901 League	C91	2-8	6/12
G13	Cricket	Cri	1-8	3
G14	No Score Cricket	NSc	1-8	3
G15	Cut throat Cricket	CUc	1-8	3
G16	Killer Cricket	LLc	2-8	3
G17	Low Pitch Cricket	LPc	1-8	3
G18	English Cricket	Enc	2	1
G19	Scram Cricket	Scc	2	1
G20	Single Only Cricket	Sic	1-8	3
G21	Double Only Cricket	dbc	1-8	3
G22	Triple Only Cricket	tPc	1-8	3
G23	Random Cricket	rdc	1-8	1
G24	Hidden Cricket	Hdc	1-4	1
G25	Count Up	CUP	1-8	9/18
G26	Light Out	Lto	1-8	3
G27	Light Up	LtU	1-8	3
G28	Color Shot 1	CS1	2	10
G29	Color Shot 2	CS2	2	10
G30	Light Off Warfare	Lof	2	1
G31	Survivor	SUr	2	7
G32	Helicopter	HLC	1-8	3
G33	Speed Wheel	L-2	1-8	3
G34	Line Up	LnU	1-8	1
G35	Bowling	boL	1-8	6

G36	Football	Ftb	1-8	1
G37	Baseball	bSb	1-8	3
G38	Golf	GoL	1-8	10
G39	Round the Clock	rCL	1-8	12
G40	Shanghai	SHi	1-8	4
G41	Halve-it	HAL	1-8	1/2
G42	Big-6	biG	2-8	19
G43	Bingo	bin	1-8	4
G44	Shoot Out	S-0	1-8	10
G45	9 Lives	9Li	2-8	7
G46	Double Down	ddn	1-8	1/2
G47	Shooting I	S-1	1-8	1/2
G48	Shooting II	S-2	1-8	1/2

**READ FIRST - OPERATION**

The dartboard can be powered by batteries or an external power supply. The battery compartment is opened from the front. Insert 3 AA batteries. An external 5 VDC, 1000 milliamp power supply is included with the dartboard. To use, remove the batteries and plug the power supply into the jack on the side of the dartboard.

1. Press the ON/OFF button to turn on the game. When the power is turned ON, the displays will light up with a welcoming melody. When the sound stops, press ENTER. Score display will show “G01” and “301” respectively.
2. Press the UP or DOWN buttons to scroll through the games. The selection is shown on the player score displays. Then press ENTER to confirm the game selection. The choices are printed on the dartboard. The number of the game is shown at the Dart Score display.
3. If you are playing a game that has the LO1 through LO6 options, press the UP or DOWN buttons to select an option and press ENTER to confirm the selection.

IF SELECTING OPTION		THEN
L01	No icons are lit up	Single In/Single Out
L02	D. IN icon lit up	Double In/Single Out
L03	D.OUT icon lit up	Single In/Double Out
L04	D. IN and D.OUT icons lit up	Double In/Double Out
L05	M. OUT icon lit up	Single In/Master Out (double or triple)
L06	D. IN and M. OUT icons lit up	Double In/Master Out (double or triple)

4. Press the UP or DOWN buttons to select number of players. There are 9 selections of players from 1 player mode to 8 players mode plus a computer player mode. Review Step 6 for handicap option. Press ENTER to confirm the selection and start the game.

For more than 4 players, some players will share the player score display.

5. If the option you selected and confirmed is the computer player mode, you will play against the computer. Three scores are shown as if darts were thrown and the score is updated. Press UP or DOWN to select the levels of the computer player and press ENTER to start the game. The five levels of computer player are as follows:





C1:	Beginner
C2:	Intermediate
C3:	Advanced
C4:	Expert
C5:	Professional

6. For some games, handicap mode can be selected after the number of players has been selected. Press the HANDICAP/QUICK CRICKET button to enter handicap selection mode. Then press UP or DOWN to select the handicap option. Press the HANDICAP/QUICK CRICKET button to jump to the next player. Press ENTER at any time to start the game. The games that use handicap mode are listed below.

<b>Game Number</b>	<b>Name</b>	<b>Handicap options</b>
G01	301	-20, -40, -60, -80 Score
G02	501	-20, -40, -60, -80 Score
G03	601	-20, -40, -60, -80 Score
G04	701	-20, -40, -60, -80 Score
G05	801	-20, -40, -60, -80 Score
G06	901	-20, -40, -60, -80 Score
G07	301 League	-20, -40, -60, -80 Score
G08	501 League	-20, -40, -60, -80 Score
G09	601 League	-20, -40, -60, -80 Score
G10	701 League	-20, -40, -60, -80 Score
G11	801 League	-20, -40, -60, -80 Score
G12	901 League	-20, -40, -60, -80 Score
G13	Cricket	L1 L2 L3 L4
G14	No Score Cricket	L1 L2 L3 L4
G15	Cut Throat Cricket	L1 L2 L3 L4
G17	Low Pitch Cricket	L1 L2 L3 L4
G20	Single Only Cricket	L1 L2 L3 L4
G21	Double Only Cricket	L1 L2 L3 L4
G22	Triple Only Cricket	L1 L2 L3 L4
G25	Count Up	+20, +40, +60, +80 Score
G26	Light Out	-1, -2, -3, -4 Light

Game Number	Name	Handicap options
G27	Light Up	-1, -2, -3, -4 Light
G29	Color Shot 2	-1, -2, -3, -4 Mark
G30	Light Off Warfare	-1, -2, -3, -4 Light
G40	Shanghai	+20, +40, +60, +80 Score
G41	Halve-It	+20, +40, +60, +80 Score
G42	Big-6	-1, -2, -3, -4 Lives
G44	Shoot Out	+1, +2, +3, +4 Marks
G45	9 Lives	-1, -2, -3, -4 Lives
G46	Double Down	+20, +40, +60, +80 Score

Handicap options L1, L2, L3 and L4 are used in the cricket games to give that player a headstart. The options give marks to a player as if they have already hit the number. The chart below shows the marks a player starts with for the selected handicap.

Handicap Options	Starting Display
L1	 20 19 18 17 16 15 B
L2	 20 19 18 17 16 15 B
L3	 20 19 18 17 16 15 B
L4	 20 19 18 17 16 15 B



7. If the game has the 25/50 Bull and Double 50/50 Bull options, you can press the UP or DOWN buttons to select and press ENTER to confirm the selection.
8. During the game, when the computer announces “next player”, any pressure on the segments will not activate the dartboard. The player is required to remove all the darts and press NEXT PLAYER for the next player’s round. The dartboard will automatically switch to the next player if the board has not been played for roughly 10 seconds after the “next player” announcement.
9. Press the MISS/RESET button to score 0 and count the dart when a dart misses the scoring segments or the board completely.
10. If you throw a dart and it doesn’t stay in the segment and you don’t want to register the score, press the BOUNCE OUT button.
11. If you want to reset the game, push the MISS/RESET button and hold for 2 seconds.
12. During the course of playing, you can press ENTER to check the scores of other players.
13. This board is equipped with a unique feature of lights behind each number which can help to identify the tracking of the targets you have hit or you need to hit. This will greatly help the players to play in most of the games and make it more enjoyable.
14. You can control the sound level by pressing the VOLUME button.
15. Several games, for example Football, will designate a segment as single, double or triple. An example for segment 5 is as follows.

Triple	Double	Single
≡ 05	▬ 05	— 05

16. Press and hold the ON/OFF button for 3 seconds to turn off the game. For energy saving purposes, the board is equipped with an auto power off feature. If the game has not been played for 15 minutes, the game will turn off automatically.
17. When the first player finishes a game, there are 2 options:
  - Continue the same game. This allows remaining players to finish and complete their information. Press the NEXT button to continue.
  - OR
  - Re-Start a new round on the same game using the same option settings. Press the ENTER button to re-start.

**GAME DESCRIPTIONS & RULES****G01 - G06 301, 501, 601, 701, 801, 901****Game Options:**

Single In/Single Out  
Double In/Single Out  
Double In/Double Out  
Single In/Double Out  
Single In/Master Out  
Double In/Master Out  
Double Bull  
Single Bull

Refer to the section "Read First - Operation".

**Playing the Game**

To win: The first player who reaches exactly zero wins.

- The starting score for each player is 301 or the score option selected.
- The score will be deducted for each dart that scores.
- You must go out with the exact number. If you go over zero the dartboard will announce "TOO HIGH, NEXT PLAYER".
- For **Single In** or **Single Out** options, the game can be started or ended by throwing at any segment, regardless if single, double or triple.
- If you selected **Double In**, you must hit a double segment or the double bullseye to start the game. If you selected **Double Out** you must hit a double segment or the double bullseye to end the game.
- For **Master Out**, the game is ended by hitting a double or triple or the double bullseye.
- If **Double Out** or **Master Out** has been selected, the Dart Out feature is automatically activated. In this mode, for a **Double Out** game, once a player is 170 or below, the computer will suggest the 3 best possible finishing shots, or if an OUT is not possible, the best remaining alternative shots are displayed. If the **Master Out** option has been selected, the suggested 3 best shots will display when a player is at 180 points or below.

**Segment Lights:**

- The segment that is hit will light up. Lights will turn off with each player change.
- The double segments will light up for the first throw in the double in games.
- Master out games will light up the preferred dart out segment.

## G07 - G12 301 League, 501, 601, 701, 801, 901

### Game Options:

Single In/Single Out  
Double In/Single Out  
Double In/Double Out  
Single In/Double Out  
Single In/Master Out  
Double In/Master Out  
Double Bull  
Single Bull

Refer to the section “Read First - Operation”.

### Playing the Game

To win: A team will win when a player on the team reaches exactly zero and his teammates score is lower than or equal to the sum of the opposing teams score.

- This game is played by 2 teams who compete with each other. It allows selection of the following 4 different team members.

Option	Description
2C	2 players in each team
3C	3 players in each team
4C	4 players in each team
Cyb	1 player VS computer player

Each team for option 2C (default) has 2 members. Team 1 is made up of player 1 and Player 3. Team 2 is made up of Player 2 and Player 4. If more players are added using options 3C and 4C, Team 1 is made up of players 1, 3, 5 and 7. Team 2 is made up of players 2, 4, 6 and 8.

- The starting score for each team is 301 or the score option selected.
- If the score of the current player goes below zero it will return to the score from the beginning of the turn. That team cannot win at that time.
- For **Single In** or **Single Out** options, the game can be started or ended by throwing at any segment, regardless if single, double or triple.
- If you selected **Double In**, you must hit a double segment or the double bullseye to start the game. If you selected **Double Out** you must hit a double segment or the double bullseye to end the game.
- For **Master Out**, the game is ended by hitting a double or triple or the double bullseye.
- If **Double Out** or **Master Out** has been selected, the Dart Out feature is automatically activated. In this mode, for a **Double Out** game, once a player is 170 or below, the computer will suggest the 3 best possible finishing shots, or if an OUT is not possible, the best remaining alternative shots are displayed. If the **Master Out** option has been selected, the suggested 3 best shots will display when a player is at 180 points or below.

- The team will win when one players score reaches exactly zero and his teammates score is lower than or equal to the sum of the opposing teams score. Otherwise the score of the current player returns to the score at the beginning of the turn. That team cannot win at that time.
- Once a players score is below 181 for **Single Out** or **Master Out**, or below 181 for **Double Out** and their teammates score is lower than or equal to the sum of the score of the opposing team, the dartboard will announce "Go For Out". This will confirm you have a chance to win in this round. If you have not met these conditions the dartboard will announce "Freeze" even if their score comes to zero.

### Segment Lights:

- The segment that is hit will light up. Lights will turn off with each player change.
- The double segments will light up for the first throw in the double in games.
- Master out games will light up the preferred dart out segment.

### G13 Cricket (with scoring options of C00, C20, C25)

#### Game Options:

Double Bull

Single Bull

The scoring options are described in the chart below.





Scoring Options	Description
C00	Hit and open numbers 15-20 and bullseye in any order.
C20	Hit and open the number 20 first, then in order, open numbers 19, 18, 17, 16, 15 and bullseye.
C25	Hit and open bullseye first, then in order, open numbers 15, 16, 17, 18, 19 and 20.

Refer to the section "Read First - Operation".

#### Playing the Game

To win: A player wins the game when he first opens all the numbers and has an equal or greater score than the other players. However, if players are tied on points, or have no points, the first player to open all numbers wins.

**Note:** A single segment counts as one hit, a double segment counts as two hits and a triple segment counts as three hits.

Cricket Status	One Time	Two Times	Open	Close
Sign				

- In Cricket only the numbers 15-20 and bullseye are used.
- All valid hits will be confirmed and displayed by the Cricket Display.
- When a number has been hit 3 times by a player, it is then open to that player and any further hits by that player will score points.
- Once a number has been hit 3 times by all the players, that number is then closed and can no longer be scored upon by any player. At that time the indicator will change to closed for that number.
- A player who has opened a number can continue to score on that number until it becomes closed.
- If a player has opened all numbers first, but is behind on points, scoring continues on open numbers. If that player has not accumulated the highest point total by the time another player opens all their numbers, the player with the most points will be the winner.

### Segment Lights:

- Segments that are in play will light up.
- Segments that are included as targets for the game will indicate how many times they have been hit.

Hits	Result
1	Double segment is off
2	The single outer segment is off
3	Opened - The triple segment is off
Closed	The single inner segment is off

### G14 No Score Cricket (with scoring options of 000, 020, 025)

#### Game Options:

Double Bull

Single Bull

The scoring options are described in the chart below.





Scoring Options	Description
000	Hit and open numbers 15-20 and bullseye in any order.
020	Hit and open the number 20 first, then in order, open numbers 19, 18, 17, 16, 15 and bullseye.
025	Hit and open bullseye first, then in order, open numbers 15, 16, 17, 18, 19 and 20.

Refer to the section “Read First - Operation”.

**Playing the Game**

To win: The first player to hit each number 3 times and open them all is the winner.

**Note:** A single segment counts as one hit, a double segment counts as two hits and a triple segment counts as three hits.

Cricket Status	One Time	Two Times	Open	Close
Sign				

- In No Score Cricket only the numbers 15-20 and bullseye are used. The first player to hit each number 3 times and open them all is the winner.
- If every player has opened a number, that number will then close.
- All valid hits will be confirmed and displayed by the Cricket Display.

**Segment Lights:**

- Segments that are in play will light up.
- Segments that are included as targets for the game will indicate how many times they have been hit.

Hits	Result
1	Double segment is off
2	The single outer segment is off
3	Opened - The triple segment is off
Closed	The single inner segment is off

**G15 Cut Throat Cricket (with scoring options of 00C, 20C, 25C)**

**Game Options:**

Double Bull

Single Bull

The scoring options are described in the chart below.





Scoring Options	Description
00C	Hit and open numbers 15-20 and bullseye in any order.
20C	Hit and open the number 20 first, then in order, open numbers 19, 18, 17, 16, 15 and bullseye.
25C	Hit and open bullseye first, then in order, open numbers 15, 16, 17, 18, 19 and 20.

Refer to the section “Read First - Operation”.

**Playing the Game**

To win: The player who first opens all numbers and has the lower score wins.

**Note:** A single segment counts as one hit, a double segment counts as two hits and a triple segment counts as three hits.

Cricket Status	One Time	Two Times	Open	Close
Sign				

- In Cut Throat Cricket only the numbers 15-20 and bullseye are used.
- If every player has opened a number, that number will then close.
- All valid hits will be confirmed and displayed by the Cricket Display.
- Once the scoring begins, points are added to your opponents scores who haven't opened that number.

**Segment Lights:**

- Segments that are in play will light up.
- Segments that are included as targets for the game will indicate how many times they have been hit.

Hits	Result
1	Double segment is off
2	The single outer segment is off
3	Opened - The triple segment is off
Closed	The single inner segment is off

**G16 Killer Cricket (with scoring options of H00, H20, H25)**

**Game Options:**

Double Bull

Single Bull

The scoring options are described in the chart below.





Scoring Options	Description
H00	Hit and open numbers 15-20 and bullseye in any order.
H20	Hit and open the number 20 first, then in order, open numbers 19, 18, 17, 16, 15 and bullseye.
H25	Hit and open bullseye first, then in order, open numbers 15, 16, 17, 18, 19 and 20.

Refer to the section "Read First - Operation".

**Playing the Game**

To win: The first player to hit each number 3 times and open them all is the winner.

**Note:** A single segment counts as one hit, a double segment counts as two hits and a triple segment counts as three hits.

Cricket Status	One Time	Two Times	Open	Close
Sign				

- In Killer Cricket only the numbers 15-20 and bullseye are used. The first player to hit each number 3 times and open them all is the winner.
- If every player has opened a number, that number will then close.
- All valid hits will be confirmed and displayed by the Cricket Display.
- When you open a point, and your opponents have not, you can eliminate your opponent's marks by hitting the same number again.

**Segment Lights:**

- Segments that are in play will light up.
- Segments that are included as targets for the game will indicate how many times they have been hit.

Hits	Result
1	Double segment is off
2	The single outer segment is off
3	Opened - The triple segment is off
Closed	The single inner segment is off

**G17 Low Pitch Cricket (with scoring options of E00, E20, E25)**

**Game Options:**

Double Bull

Single Bull

The scoring options are described in the chart below.

Scoring Options	Description
E00	Hit and open numbers 1-6 and bullseye in any order.
E20	Hit and open the number 6 first, then in order, open numbers 5, 4, 3, 2, 1 and bullseye.
E25	Hit and open bullseye first, then in order, open numbers 1, 2, 3, 4, 5 and 6.





Refer to the section "Read First - Operation".



**Playing the Game**

To win: A player wins the game when he first opens all the numbers and has an equal or greater score than the other players. However, if players are tied on points, or have no points, the first player to open all numbers wins.

**Note:** A single segment counts as one hit, a double segment counts as two hits and a triple segment counts as three hits.

Cricket Status	One Time	Two Times	Open	Close
Sign				

- In Low Pitch Cricket only the numbers 1-6 and bullseye are used.
- All valid hits will be confirmed and displayed by the Cricket Display.
- When a number has been hit 3 times by a player, it is then open to that player and any further hits by that player will score points.
- Once a number has been hit 3 times by all the players, that number is then closed and can no longer be scored upon by any player. At that time the indicator will change to closed for that number.
- A player who has opened a number can continue to score on that number until it becomes closed.
- If a player has opened all numbers first, but is behind on points, scoring continues on open numbers. If that player has not accumulated the highest point total by the time another player opens all their numbers, the player with the most points will be the winner.

**Segment Lights:**

- Segments that are in play will light up.
- Segments that are included as targets for the game will indicate how many times they have been hit.

Hits	Result
1	Double segment is off
2	The single outer segment is off
3	Opened - The triple segment is off
Closed	The single inner segment is off

**G18 English Cricket****Game Options:**

Double Bull

Single Bull

Refer to the section "Read First - Operation".

**Playing the Game**

To win: The player with the most points is the winner.

- This game is for 2 players only.
- The game consists of two rounds. In round one, the target of player one is the bullseye, each hit of the outer bull counts as one mark, inner bull counts as two marks, and the other numbers are counted as 0 marks.
- The object of Player 2 is to get the highest possible score before Player 1 accumulates 9 marks.
- Player 2's score is counted only when the total score of three darts is over 40 otherwise it counts as 0 points.
- Player 2 can throw at any number. However, if player 2 achieves a score of 42, it counts as 2 points, if player 2 achieves a score of 59 , it counts as 19 points.
- The first round is finished when Player 1 accumulates 9 marks. In round two, the players change their roles. Player 2 throws for the bullseye and Player 1 goes for points.
- The game is over when Player 2 accumulates 9 marks.

**Segment Lights:**

- Segments that are in play will light up.
- Segments that are included as targets for the game will indicate how many times they have been hit.

Hits	Result
1	Double segment is off
2	The single outer segment is off
3	Opened - The triple segment is off
Closed	The single inner segment is off

**G19 Scram Cricket**

**Game Options:**





Double Bull  
Single Bull

Refer to the section “Read First - Operation”.

**Playing the Game**

To win: During round 2, if Player 1’s score goes over Player 2’s score the game will end and Player 1 will be the winner. If Player 2 closes all the numbers and has a higher score than Player 1, Player 2 will be the winner.

**Note:** A single segment counts as one hit, a double segment counts as two hits and a triple segment counts as three hits.

Cricket Status	One Time	Two Times	Open	Close
Sign				

- All valid hits will be confirmed and displayed by the Cricket Display.
- The game consists of 2 rounds. In the first round, player 1 must close 15 through 20 and bullseye while player 2 attempts to get as high a score as he can by scoring on the open numbers. Round 1 will be finished when all numbers have been closed. For round 2, the reverse is done. Player 2 attempts to close 15 through 20 and the bullseye. Player 1 attempts to get a high score.
- During round 2, if Player 1’s score goes over Player 2’s score the game will end and Player 1 will be the winner. If Player 2 closes all the numbers and has a higher score than Player 1, Player 2 will be the winner.

**Segment Lights:**

- Segments that are in play will light up.
- Segments that are included as targets for the game will indicate how many times they have been hit.

Hits	Result
1	Double segment is off
2	The single outer segment is off
3	Opened - The triple segment is off
Closed	The single inner segment is off

**G20 Single Only Cricket without Double and Triple (with scoring options of S00, S20, S25)**

**Game Options:**

Double Bull

Single Bull

The scoring options are described in the chart below.





Scoring Options	Description
S00	Hit and open numbers 15-20 and bullseye in any order.
S20	Hit and open the number 20 first, then in order, open numbers 19, 18, 17, 16, 15 and bullseye.
S25	Hit and open bullseye first, then in order, open numbers 15, 16, 17, 18, 19 and 20.

Refer to the section “Read First - Operation”.

**Playing the Game**

To win: A player wins the game when he first opens all the numbers and has an equal or greater score than the other players. However, if players are tied on points, or have no points, the first player to open all numbers wins.

**Note:** A single, double, and triple segment counts as one hit. A single bull and a double bull counts as one hit.

Cricket Status	One Time	Two Times	Open	Close
Sign				

- In Single Only Cricket only the numbers 15-20 and bullseye are used.
- All valid hits will be confirmed and displayed by the Cricket Display.
- When a number has been hit 3 times by a player, it is then open to that player and any further hits by that player will score points.
- Once a number has been hit 3 times by all the players, that number is then closed and can no longer be scored upon by any player. At that time the indicator will change to closed for that number.
- A player who has opened a number can continue to score on that number until it becomes closed.
- If a player has opened all numbers first, but is behind on points, scoring continues on open numbers. If that player has not accumulated the highest point total by the time another player opens all their numbers, the player with the most points will be the winner.

**Segment Lights:**

- Segments that are in play will light up.
- Segments that are included as targets for the game will indicate how many times they have been hit.

Hits	Result
1	Double segment is off
2	The single outer segment is off
3	Opened - The triple segment is off
Closed	The single inner segment is off

**G21 Doubles Only Cricket (with scoring options of d00, d20, d25)**

**Game Options:**

Double Bull

Single Bull

The scoring options are described in the chart below.





Scoring Options	Description
d00	Hit and open numbers 15-20 and bullseye in any order.
d20	Hit and open the number 20 first, then in order, open numbers 19, 18, 17, 16, 15 and bullseye.
d25	Hit and open bullseye first, then in order, open numbers 15, 16, 17, 18, 19 and 20.

Refer to the section “Read First - Operation”.

**Playing the Game**

To win: A player wins the game when he first opens all the numbers and has an equal or greater score than the other players. However, if players are tied on points, or have no points, the first player to open all numbers wins.

**Note:** Single and triple segments are not used in this game. Only double segments and the double bull count. A double segment or double bull only counts as 1 hit.

Cricket Status	One Time	Two Times	Open	Close
Sign				

- In Doubles Only Cricket only the numbers 15-20 and bullseye are used.
- All valid hits will be confirmed and displayed by the Cricket Display.
- When a number has been hit 3 times by a player, it is then open to that player and any further hits by that player will score points.

- Once a number has been hit 3 times by all the players, that number is then closed and can no longer be scored upon by any player. At that time the indicator will change to closed for that number.
- A player who has opened a number can continue to score on that number until it becomes closed.
- If a player has opened all numbers first, but is behind on points, scoring continues on open numbers. If that player has not accumulated the highest point total by the time another player opens all their numbers, the player with the most points will be the winner.

**Segment Lights:**

- Segments that are in play will light up.
- Segments that are included as targets for the game will indicate how many times they have been hit.

Hits	Result
1	Double segment is off
2	The single outer segment is off
3	Opened - The triple segment is off
Closed	The single inner segment is off

**G22 Triples Only Cricket (with scoring options of T00, T20, T25)****Game Options:**

Double Bull

Single Bull

The scoring options are described in the chart below.





Scoring Options	Description
T00	Hit and open numbers 15-20 and bullseye in any order.
T20	Hit and open the number 20 first, then in order, open numbers 19, 18, 17, 16, 15 and bullseye.
T25	Hit and open bullseye first, then in order, open numbers 15, 16, 17, 18, 19 and 20.

Refer to the section “Read First - Operation”.

**Playing the Game**

To win: A player wins the game when he first opens all the numbers and has an equal or greater score than the other players. However, if players are tied on points, or have no points, the first player to open all numbers wins.

**Note:** Single and double segments are not used in this game. Only triple segments and the double bull count. A triple segment or double bull only counts as 1 hit.

Cricket Status	One Time	Two Times	Open	Close
Sign				

- In Triples Only Cricket only the numbers 15-20 and bullseye are used.
- All valid hits will be confirmed and displayed by the Cricket Display.
- When a number has been hit 3 times by a player, it is then open to that player and any further hits by that player will score points.
- Once a number has been hit 3 times by all the players, that number is then closed and can no longer be scored upon by any player. At that time the indicator will change to closed for that number.
- A player who has opened a number can continue to score on that number until it becomes closed.
- If a player has opened all numbers first, but is behind on points, scoring continues on open numbers. If that player has not accumulated the highest point total by the time another player opens all their numbers, the player with the most points will be the winner.

**Segment Lights:**

- Segments that are in play will light up.
- Segments that are included as targets for the game will indicate how many times they have been hit.

Hits	Result
1	Double segment is off
2	The single outer segment is off
3	Opened - The triple segment is off
Closed	The single inner segment is off

**G23 Random Cricket**

Refer to the section “Read First - Operation”.

**Playing the Game**

To win: The first player to open all the numbers wins.

- This game is the same as American Cricket EXCEPT that the e-Board Computer will randomly select numbers for you to hit. The first two digits on the display will show the player number (this will be a solid number, not flashing). The random numbers will flash on the display and the board will light up the segment.
- Once a player hits one of the designated random numbers it will stop flashing and become solid. This number is now locked in for all players for the rest of the game. Numbers can be hit in any order.
- Once a players turn is over, the flashing numbers will change to a different set of random numbers. The numbers that are locked in (solid numbers) will stay the same.
- You have to hit each designated number three times to open it. Double segments count as two hits and triple segments count as three hits.

**Segment Lights:**

- Segments that are in play will light up.
- Segments that are included as targets for the game will indicate how many times they have been hit.

Hits	Result
1	Double segment is off
2	The single outer segment is off
3	Opened - The triple segment is off
Closed	The single inner segment is off





**G24 Hidden Cricket**

Refer to the section “Read First - Operation”.

**Playing the Game**

To win: The first player to hit each number 3 times and open them all is the winner.

**Note:** A single segment counts as one hit, a double segment counts as two hits and a triple segment counts as three hits.

Cricket Status	One Time	Two Times	Open	Close
Sign				



- The segments will be random targets that are not lit.
- When the target is hit, the segment will light up.
- In No Score Cricket the first player to hit each number 3 times and open them all is the winner.
- If every player has opened a number, that number will then close.
- All valid hits will be confirmed and displayed by the Cricket Display.

### Segment Lights:

- Segments that are in play will light up.
- Segments that are included as targets for the game will indicate how many times they have been hit.

Hits	Result
1	Double segment is off
2	The single outer segment is off
3	Opened - The triple segment is off
Closed	The single inner segment is off

### G25 Count Up (with scoring options of 100, 200, 300, 400, 500, 600, 700, 800, 900)

#### Game Options:

Double Bull

Single Bull

The scoring options are the set points which are the points needed to win, see the chart below.

Scoring Option	100	200	300	400	500	600	700	800	900
Set Points	100	200	300	400	500	600	700	800	900

Refer to the section "Read First - Operation".

#### Playing the Game

To win: The first player to reach or go over the set points will be the winner.

- Your score will be accumulated for each dart.

**G26 Light Out (with scoring options of LO1, LO2, LO3)**

The scoring options are described in the chart below.

<b>Scoring Option</b>	<b>LO1</b>	<b>LO2</b>	<b>LO3</b>
	Hit any of the numbers segments to turn off the light.	Hit the single and the double segments to turn off the light.	Hit the single, double and triple segments to turn off the light.

Refer to the section “Read First - Operation”.

**Playing the Game**

To win: The first player to turn all the lights off is the winner.

**Segment Lights:**

- All segments are lit at the start of the game.

**G27 Light Up (with scoring options of LO1, LO2, LO3)**

The scoring options are described in the chart below.

<b>Scoring Option</b>	<b>LO1</b>	<b>LO2</b>	<b>LO3</b>
	Hit any of the numbers segments to turn on the light.	Hit the single and the double segments to turn on the light.	Hit the single, double and triple segments to turn on the light.

Refer to the section “Read First - Operation”.

**Playing the Game**

To win: The first player to turn all the lights on is the winner.

**Segment Lights:**

- All segments are off at the start of the game.

**G28 Color Shot 1 (with options of 003, 004, 005, 006, 007, 008, 009, 010, 011, 012)**

The scoring options are the number of rounds each player has available to hit the most segments of their color.

<b>Scoring Option</b>	<b>003</b>	<b>004</b>	<b>005</b>	<b>006</b>	<b>007</b>	<b>008</b>	<b>009</b>	<b>010</b>	<b>011</b>	<b>012</b>
<b>Number of Rounds</b>	3	4	5	6	7	8	9	10	11	12

Refer to the section “Read First - Operation”.

**Playing the Game**

To win: The first player that hits their color and earns the most marks is the winner.

- This is a two player game.
- Each player has their own color.
- Each hit on the correct color segment will score marks:  
Single segment scores 1 mark  
Double segment scores 2 marks  
Triple segment scores 3 marks

**Segment Lights:**

- Segments light up and display one of two colors.

**G29 Color Shot 2 (with options of 006, 007, 008, 009, 010, 011, 012, 013, 014, 015)**

The scoring options are the number of rounds each player has available to hit the most segments of their color.

<b>Scoring Option</b>	<b>006</b>	<b>007</b>	<b>008</b>	<b>009</b>	<b>010</b>	<b>011</b>	<b>012</b>	<b>013</b>	<b>014</b>	<b>015</b>
<b>Number of Rounds</b>	3	4	5	6	7	8	9	10	11	12

Refer to the section “Read First - Operation”.

**Playing the Game**

To win: The first player that hits their color and reduces their marks to zero is the winner.

- This is a two player game.
- Each player has their own color.
- Each hit on the correct color segment will eliminate marks:  
Single segment eliminates 1 mark  
Double segment eliminates 2 marks  
Triple segment eliminates 3 marks

**Segment Lights:**

- Segments light up and display one of two colors.

**G30 Light Off Warfare**

Refer to the section “Read First - Operation”.

**Playing the Game**

To win: Hit segments on the opponent's side of the battlefield. The first player to turn off all the opponent's lights is the winner.

- Player 1 battlefield is segments 14 to 13
- Player 2 battlefield is segments 10 to 8
- Segments 11 and 6 do not count
- Throw at the opponent's segments to turn the light out.

**Segment Lights:**

- Game starts with segments lit. Lights are turned off when hit.

**G31 Survivor (with options of 10r, 11r, 12r, 13r, 14r, 15r, 16r)**

The scoring options are the number of rounds played.

Scoring Option	10r	11r	12r	13r	14r	15r	16r
Number of Rounds	10	11	12	13	14	15	16

Refer to the section “Read First - Operation”.

**Playing the Game**

To win: The player that reduces the opponent to zero points or has the most points at the end of the rounds, wins.

- This is a two player game.
- Each player starts with 200 life points.
- The board will light up a four segment number to be the opponent. Hitting one of these segments will reduce the opponent's life points.
- The board will simultaneously light a single segment to provide life points. Hitting this segment will add life points to the throwing players score.
- Points added or deducted will follow the normal segment scoring. Double and triple segments will score double and triple life points.
- If a player is reduced to zero life points, they lose.
- If the game lasts through the selected number of rounds, the player with the highest point total wins.

**Segment Lights:**

- Segments light up to designate targets.

**G32 Helicopter (with options of LO1, LO2, LO3)**

The scoring options are the speed of rotation.

<b>Scoring Option</b>	<b>LO1</b>	<b>LO2</b>	<b>LO3</b>
<b>Blade Rotation Speed</b>	Slow	Moderate	Fast

Refer to the section “Read First - Operation”.

**Playing the Game**

To win: The first player to hit all 4 moving segments and turn off the lights, wins.

- Four segments will light and then rotate in a clockwise (right hand) direction.
- Hit the moving blade to turn off a light.
- The player to turn off the last light wins.

**Segment Lights:**

- Four blades will light and rotate around the board.

**G33 Speed Wheel (with options of LO1, LO2, LO3)**

The scoring options are the speed of rotation.

<b>Scoring Option</b>	<b>LO1</b>	<b>LO2</b>	<b>LO3</b>
<b>Blade Rotation Speed</b>	Slow	Moderate	Fast

Refer to the section “Read First - Operation”.

**Playing the Game**

To win: Hit the moving blade one time.

- One number will light up.
- The lights will rotate around the board in both clockwise (right hand) and counter clockwise (left hand) directions.
- The first player to hit the lit segment wins.

**Segment Lights:**

- One blade will light and rotate around the board.

**G34 Line Up**

Refer to the section “Read First - Operation”.

**Playing the Game**

To win: Create a line by hitting all the segments of two numbers that are opposite of each other. This line includes the bullseyes..

- Players can hit as many segments as they wish.
- The segments will light up.
- Each player throws until one player has created a line using all the segments (including bullseyes) that are across from each other. This will light up a line.

**Segment Lights:**

- A segment that is hit will light up.

**G35 Bowling (with scoring options of 10r, 11r, 12r, 13r, 14r, 15r)**

The scoring options are the number of rounds, see the chart below.

Scoring Option	10r	11r	12r	13r	14r	15r
No. of Rounds	10	11	12	13	14	15

Refer to the section “Read First - Operation”.

**Playing the Game**

To win: The player with the highest score wins.

- For each turn the score section will display SEL. Your first dart will select the “Alley”. The Alley will light up. The second and third dart will score “pins” or points. Hitting the bullseye will not count as an “Alley” or give you any “pins” or points. “Pins” or points are scored as follows:

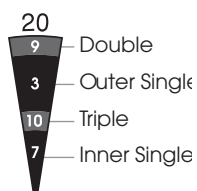
Segments	Score	
Double	9 Pins	
Outer Single	3 Pins	
Triple	10 Pins	
Inner Single	7 Pins	

- A player cannot hit the same single segment twice in the same frame. The second hit will be counted as zero.
- You can hit the same triple or double segment twice. However hitting the double segment twice in a row will only give you 10 “pins” or points. Hitting the triple segment twice will give you 20 “pins” or points.
- The perfect game is 200/220/240/260/280/300 respectively for the options chosen.

**Segment Lights:**

- The alley will light up when it is selected.

## G36 Football

Refer to the section “Read First - Operation”.

### Playing the Game

To win: The first player who finishes crossing their playing field is the winner.

- Before starting the game you must select the number of players.
- To start the game the e-BOARD Computer will display “CHOOSE A NUMBER”. The player will then throw a dart at the board to determine their “number” or “playing field”. The playing field will light up.
- Once a “playing field” is selected, you must hit the segments in order from the outside double segment of your “number” working your way in to the bullseye and to the opposite side to the outer double segment. See illustration and example below.

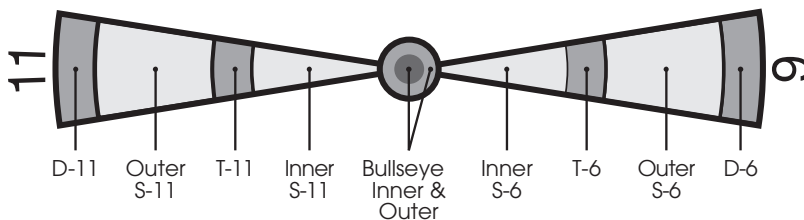

- For example, if a player selects segment 11, they have to hit in order, D-11, outer S-11, T-11, inner S-11, outer bullseye, inner bullseye, outer bullseye, inner S-6, T-6, outer S-6 and finally D-6.
- A dart that hits a segment out of their playing field or out of order is a miss.

### Segment Lights:

- Selected playing fields will light up.

**G37 Baseball (with scoring options of b07, b08, b09)**

The scoring options are the number of innings, see the chart below.

Scoring Option	b07	b08	b09
No. of Innings	7	8	9

Refer to the section “Read First - Operation”.

**Playing the Game**

To win: The player with the most runs at the end of the game is the winner.

- A baseball field is layed out as shown in diagram below. A player throws 3 darts in each inning and the runs/bases are set as follows:

Segments	Result
Single	One Base
Double	Two Bases
Triple	Three Bases
Bullseye	Home Run

- A home run can only be scored on the 3rd dart of each turn.
- The first cricket display will show what base your “runners” are on. 16 is your first “runner” or dart, 18 is your second and 20 is your third. The table below will show the symbols displayed for the base that your “runner” is on.

1st Base	2nd Base	3rd Base	Home
\	X	⊗	○

The second cricket display will show the number of innings left.

**Segment Lights:**

- The playfield is lit.

**G38 Golf (with scoring options of 09F, 10F, 11F, 12F, 13F, 14F, 15F, 16F, 17F, 18F)**

The scoring options are the number of “holes”, see the chart below.

Scoring Option	09F	10F	11F	12F	13F	14F	15F	16F	17F	18F
No. of Holes	9	10	11	12	13	14	15	16	17	18

Refer to the section “Read First - Operation”.



**Playing the Game**

To win: The first person to complete all their “holes” with the lowest strokes wins and the game is over.

- Numbers 1-18 are the “Holes” of the golf course and must be hit in order.
- Players must hit each number three times before they can move on to the next “hole”.
- A double will count as two hits, a triple will count as three hits.
- The number that must be hit will be lit.
- Each dart thrown counts as a “stroke” and will be displayed on the score section of the board.
- The cricket display will show how many “holes” are left.
- The bullseye counts as a miss.

**Segment Lights:**

- The designated target will be lit.

**G39 Round-The-Clock (with scoring options of 105, 110, 115, 120, 205, 210, 215, 220, 305, 310, 315, 320)**

The scoring options are the last number that will be thrown and the segment that must be hit, see the chart below.

<b>Scoring Option</b>	105	110	115	120				
<b>Last Number Thrown</b>	5	10	15	20				
<b>Scoring Option</b>	205	210	215	220	305	310	315	320
<b>Last Number Thrown</b>	5	10	15	20	5	10	15	20
	Must hit only Double segments				Must hit only Triple segments			

Refer to the section “Read First - Operation”.

**Playing the Game**

To win: The first player to hit all the designated numbers in order, wins.

- Players must hit numbers 1 through 5 (or 10, 15, 20) in order.
- The dartboard will display the number that must be hit during that turn.
- The number can be hit in any segment (single, double or triple).
- A player has to hit the designated number to move on to the next number.
- The scoreboard for each player will display the number of the segment that must be hit.

**Segment Lights:**

- The number that must be hit will light.

**G40 Shanghai (with scoring options of L01, L05, L10, L15)**

The scoring options are described in the chart below.

<b>Scoring Option</b>	L01	L05	L10	L15
<b>Game starts on number</b>	1	5	10	15

Refer to the section “Read First - Operation”.

**Playing the Game**

To win: The player who gets the most points at the end of the game wins.

- Each player must hit the numbers and the bullseye in order. The game will start on the number selected with the scoring option.
- The dartboard will light the target number you are supposed to hit.
- The target number will change by one after each dart and will end with the bullseye.
- A dart that misses the target segments does not score.
- Your score is the number of the target segment you are on.
- Hitting a double segment in the number you are on will double your points, likewise a triple will triple your points. For example if you are on number 4 and you hit a single in segment 4 you get 4 points. If you are on number 4 and you hit a double segment 4 you get 8 points.

**Segment Lights:**

- The designated target will be lit.

**G41 Halve-It**

**Game Options:**

Double Bull

Single Bull

There are twelve rounds of three darts each in this game. Each round has a target number you must hit to score points. The dartboard will display the number you need to hit for that round. The target numbers for each round are:

<b>Round</b>	1	2	3	4	5	6
<b>Target Number</b>	12	13	14	Any Double	15	16
<b>Round</b>	7	8	9	10	11	12
<b>Target Number</b>	17	Any Triple	18	19	20	Bullseye

Refer to the section “Read First - Operation”.

**Playing the Game**

To win: The player with the highest score after all twelve rounds wins.

- Players take turns throwing darts and attempting to score points.

- If you hit the target number for that round, you will get that number in points. Double segments will double your points and triple segments will triple your points. For example, in Round 1 you have to hit the number 12. If you hit it in a single segment you will get 12 points. If you hit the double 12 you will get 24 points and the triple 12 will give you 36 points.
- For Round 4 you can only score by hitting any double segment.
- For round 8 you can only score by hitting any triple segment and for Round 12 you can only score by hitting the bullseye.
- If a player misses the designated number on all three darts in a round, their total score is cut in half.

### Segment Lights:

- The designated target will be lit.

### G42 Big-6 (with scoring options of b03, b04, b05, b06, b07, b08, b09, b10, b11, b12, b13, b14, b15, b16, b17, b18, b19, b20, b21)

The scoring options are the number of lives, see the chart below.

<b>Scoring Option</b>	b03	b04	b05	b06	b07	b08	b09	b10	b11	b12
<b>No. of Lives</b>	3	4	5	6	7	8	9	10	11	12
<b>Scoring Option</b>	b13	b14	b15	b16	b17	b18	b19	b20	b21	
<b>No. of Lives</b>	13	14	15	16	17	18	19	20	21	

Refer to the section “Read First - Operation”.

### Playing the Game

To win: If a player loses all their lives they are out of the game. The remaining players continue the game until one player is left with lives. That player is the winner.

- This game allows a player to challenge opponents to hit the targets of the player's choice. The dartboard will display the single 6 segment as the first target. Players must earn the chance to pick the next target for their opponent by making a hit on the single 6 target. If they hit the single 6, the dartboard will display - - -. They can then throw a dart to select the next target. That number and segment then becomes the target. The scoreboard will display the target. In any turn if the player does not hit the designated target they lose one life.
- If a player hits the target with the first or second dart, the next dart then determines the next target and that player's turn is over.
- If a player hits the target with the third dart their turn is over and the computer will display a new target. A life is not lost.

### Segment Lights:

- The designated target will be lit.

**G43 Bingo (with scoring options of 132, 141, 168, 189)**

The scoring options are described in the chart below.

Scoring Options	Description
132	Hit segments 15, 4, 8, 14, 3 in order.
141	Hit segments 17, 13, 9, 7, 1 in order.
168	Hit segments 20, 16, 12, 6, 2 in order.
189	Hit segments 19, 10, 18, 5, 11 in order.

Refer to the section “Read First - Operation”.

**Playing the Game**

To win: The player that hits the specified targets three times is the winner.

- The player should hit a number segment three times to enter into the next number segment.
- Hitting the single segment counts as one time; the double segment counts as two times; the triple segment counts as three times.
- The cricket display will keep track of the correct hits.

**Segment Lights:**

- The designated target will be lit.

**G44 Shoot Out (with scoring options of -03, -04, -05, -06, -07, -08, -09, -10, -11, -12, -13, -14, -15, -16, -17, -18, -19, -20, -21)**

The scoring options are the number of marks you must hit, see the chart below.

<b>Scoring Option</b>	-03	-04	-05	-06	-07	-08	-09	-10	-11	-12
<b>Starting Score</b>	3	4	5	6	7	8	9	10	11	12
<b>Scoring Option</b>	-13	-14	-15	-16	-17	-18	-19	-20	-21	
<b>Starting Score</b>	13	14	15	16	17	18	19	20	21	

Refer to the section “Read First - Operation”.

**Playing the Game**

To win: The first player who hits the number of correct segments, depending on the option selected, is the winner.

- The Computer will randomly select and light up a number for the player to hit.
- One correct hit on a segment of the displayed number subtracts one from the score.
- Single, double and triple segments all count as one hit.
- If a player does not hit the selected number within 10 seconds, the dart is regarded as a miss and the Computer will automatically select another random number for the player to hit for the next dart.

**Segment Lights:**

- The designated target will be lit.

## G45 9 Lives (with scoring options of 003, 004, 005, 006, 007, 008, 009)

The scoring options are the number of marks you must hit, see the chart below.

Scoring Option	003	004	005	006	007	008	009
No. of Lives	3	4	5	6	7	8	9

Refer to the section “Read First - Operation”.

### Playing the Game

To win: The last player remaining alive is the winner.

- This game plays numbers 1 through 20 and bullseye in a sequence loop. Players take turns throwing at 1 in the first round, 2 in the second round, and so on, until “25” in the 21st round, 1 in the 22nd round and so on.
- Each player must hit the target number with one dart in each round.
- The cricket display will keep track of lives remaining.
- A player will lose a life if all 3 darts miss.

### Segment Lights:

- The designated target will be lit.

## G46 Double Down

### Game Options:

Double Bull

Single Bull

Refer to the section “Read First - Operation”.

### Playing the Game

To win: The player with the highest score after the last round is the winner.

- This game starts with a base score of 60 points for each player.
- There are 9 rounds for each player. Each round has a number or segment that you must hit in order to score.
- The dartboard will light up the number you must hit for that round. The designated numbers for each round are:

Round	1	2	3	4	5	6	7	8	9
Target Number	15	16	Any Double	17	18	Any Triple	19	20	Bullseye

- Each dart that hits the correct number will score points based on the number and the segment. For example, if you hit number 15 single segment you will get 15 points. If you hit the number 15 double segment you would get 30 points. If you hit the number 15 triple segment you would get 45 points.
- If the player does not hit the designated number during their round their score is cut in half and they move on to the next round on their next turn.
- For the Any Double and Any Triple, the player must hit any double or triple segment. If the doubles and triples are not hit, the player's score is cut in half.

## **Segment Lights:**

- The designated target will be lit.

## **G47 Shooting I**

### **Game Options:**

Double Bull

Single Bull

Refer to the section "Read First - Operation".

### **Playing the Game**

To win: Winner is the first one to win 7 rounds.

- In this game, each player throws three darts. The player with the highest 3 dart total wins that round.
- Double segments count as double the points and triple segments count as triple the points.

## **G48 Shooting II**

### **Game Options:**

Double Bull

Single Bull

Refer to the section "Read First - Operation".

### **Playing the Game**

To win: Winner is the first one to win 7 rounds.

- In this game, each player throws three darts. The player with the highest 3 dart total wins that round.
- Only darts that land in the single, double or triple areas of the following Target Area numbers will count towards the score: 15, 16, 17, 18, 19, 20 and bullseye.
- The cricket display will keep track of the rounds the player has won.
- Double segments count as double the points and triple segments count as triple the points.

This page is left intentionally blank.

## ONE YEAR LIMITED WARRANTY

The Manufacturer warrants to the original retail purchaser that this product is free from defects in material and workmanship under normal use and conditions for a period of one year from the date of original purchase. The Manufacturer's liability is limited to the repair or replacement, at its option, of any defective product and shall not include any liability for indirect, incidental or consequential damages of any kind.

Should this product become defective due to material or workmanship within the warranty period, contact our Customer Service Department. This warranty is not transferable and does not cover normal wear and tear or damage caused by improper usage, negligence, misuse, abuse, transportation damage, acts of nature, or accident (including failure to follow the instructions in this manual). It does not cover expendable items such as batteries, light bulbs, fuses, accessories, cosmetic parts and other items that wear out due to normal usage, including felt covered areas of the playing surface. This warranty is also void if the product is disassembled and reassembled, damaged, modified from its original state, or used for other than indoor personal residential use (no commercial or rental applications). This warranty gives you specific legal rights, and you may have other rights which vary from state to state.

### **IF YOU HAVE A WARRANTY CLAIM, CALL US FIRST (8 - 4:30 CST):**

**Please have your receipt and item number (found on the front cover) when you call.**

#### ***GLD Products***

S84 W19093 Enterprise Drive  
Muskego, WI 53150 USA

1-800-225-7593

Fax: 1-800-841-6944

Email: [gld@gldmfg.com](mailto:gld@gldmfg.com)

Web: [www.gldproducts.com](http://www.gldproducts.com)

**If you are instructed to return the product for service, you are responsible for shipping the unit at your expense to the above address in packaging that will protect against further damage. All warranty or repair requests require a Return Authorization Number prior to returning the item.**

### **PRODUCT REGISTRATION**

**Important:** The product registration form on page 49 must be completed and returned along with a copy of your receipt within 10 days of purchase to validate your warranty.

On-line registration is also available.

Go to <http://gldproducts.com/warranty-information> or click on this link. Follow the on-line instructions.



# REGISTER YOUR PRODUCT

Place postage here

Complete this form, include a copy of your receipt, fold, tape (do not staple) and return within 10 days of purchase. This protects your warranty and will help us develop new products!

Cut here.

**GLD Products**  
Warranty Department  
S84 W19093 Enterprise Drive  
Muskego, WI 53150 USA

Fold here second.



[www.gldproducts.com](http://www.gldproducts.com)

- |                       |                            |
|-----------------------|----------------------------|
| GAME TABLES           | HOME CASINO                |
| GAMES AND ACCESSORIES | BILLIARD CUES              |
| BILLIARD ACCESSORIES  | DARTBOARDS                 |
| SOFT-TIP DARTS        | STEEL-TIP DARTS            |
| FLIGHTS AND SHAFTS    | DART CASES AND ACCESSORIES |

Fold here first.

Name	Date of Purchase
Address	Phone-Day
City	Phone-Evening
State                      Zip	Email
Purchase Price:	Item: <b>42-0003 Ion Electronic Dartboard</b>
Store Name:	

**Remember to attach a copy of your receipt.**

This page is left intentionally blank.

**Mail To: GLD Products**  
S84 W19093 Enterprise Drive  
Muskego, WI 53150 USA  
1-800-225-7593 • FAX 800-841-6944  
Email: [gld@gldmfg.com](mailto:gld@gldmfg.com)  
Web Site: [www.gldproducts.com](http://www.gldproducts.com)

## ***Ion Dartboard***

Item 42-0003

Please call or consult the GLD website, [GLDProducts.com](http://GLDProducts.com) to order the following parts:

<b>Order No.</b>	<b>Description</b>
42-9987	1000 mA Adapter Positive Outer
6-44	2 Piece Bullseye, Nylon
6-49	Pie Section, Blue Segments, Nylon
6-50	Pie Section, Green Segments, Nylon
6-51	Pie Section, Grey Segments, Nylon
6-15	Set of 3 Soft Tip Darts
37-1652-01	Tips, 100 pcs
6-38	Aluminum Shafts 3 pc
6-11	Mounting Hardware
6-14	Flights 3 pc, designs vary
Accessories	
37-0125	Viper Bull Throw Line
37-0106	Viper Vinyl Dart Mat

**NOTE:** After a product has been discontinued for a period of one year, GLD will not guarantee that replacements parts are available.

This page is left intentionally blank.



[www.gldproducts.com](http://www.gldproducts.com)

**GAME TABLES**

**HOME CASINO**

**GAMES AND ACCESSORIES**

**BILLIARD CUES**

**BILLIARD ACCESSORIES**

**DARTBOARDS**

**SOFT-TIP DARTS**

**STEEL-TIP DARTS**

**FLIGHTS AND SHAFTS**

**DART CASES AND ACCESSORIES**



**PROUD MANUFACTURER OF**



S84 W19093 Enterprise Drive • Muskego, WI 53150 USA  
262.679.8730 or 1.800.225.7593 tele  
262.679.8738 or 1.800.841.6944 fax  
Email: [gld@gldmfg.com](mailto:gld@gldmfg.com)  
[www.gldproducts.com](http://www.gldproducts.com)

Game	Name	Number of Players	Number of Options	In/Out Single/DBL/Master	Bullseye Single/DBL
G01	301	1-8	6/12	Yes	Yes
G02	501	1-8	6/12	Yes	Yes
G03	601	1-8	6/12	Yes	Yes
G04	701	1-8	6/12	Yes	Yes
G05	801	1-8	6/12	Yes	Yes
G06	901	1-8	6/12	Yes	Yes
G07	301 League	2-8	6/12	Yes	Yes
G08	501 League	2-8	6/12	Yes	Yes
G09	601 League	2-8	6/12	Yes	Yes
G10	701 League	2-8	6/12	Yes	Yes
G11	801 League	2-8	6/12	Yes	Yes
G12	901 League	2-8	6/12	Yes	Yes
G13	Cricket	1-8	3	N/A	N/A
G14	No Score Cricket	1-8	3	N/A	N/A
G15	Cut throat Cricket	1-8	3	N/A	N/A
G16	Killer Cricket	2-8	3	N/A	N/A
G17	Low Pitch Cricket	1-8	3	N/A	N/A
G18	English Cricket	2	1	N/A	N/A
G19	Scram Cricket	2	1	N/A	N/A
G20	Single Only Cricket	1-8	3	N/A	N/A
G21	Double Only Cricket	1-8	3	N/A	N/A
G22	Triple Only Cricket	1-8	3	N/A	N/A
G23	Random Cricket	1-8	1	N/A	N/A
G24	Hidden Cricket	1-4	1	N/A	N/A
G25	Count Up	1-8	9/18	Yes	Yes
G26	Light Out	1-8	3	N/A	N/A
G27	Light Up	1-8	3	N/A	N/A
G28	Color Shot 1	2	10	N/A	N/A
G29	Color Shot 2	2	10	N/A	N/A
G30	Light Off Warfare	2	1	N/A	N/A
G31	Survivor	2	7	N/A	N/A
G32	Helicopter	1-8	3	N/A	N/A
G33	Speed Wheel	1-8	3	N/A	N/A
G34	Line Up	1-8	1	N/A	N/A
G35	Bowling	1-8	6	N/A	N/A
G36	Football	1-8	1	N/A	N/A
G37	Baseball	1-8	3	N/A	N/A
G38	Golf	1-8	10	N/A	N/A
G39	Round the Clock	1-8	12	N/A	N/A
G40	Shanghai	1-8	4	N/A	N/A
G41	Halve-it	1-8	1/2	N/A	N/A
G42*	Big-6	2-8	19	N/A	N/A
G43	Bingo	1-8	4	N/A	N/A
G44	Shoot Out	1-8	10	N/A	N/A
G45	9 Lives	2-8	7	N/A	N/A

**Quick Reference For Ion Dartboard Item 42-0003**

Game	Name	Number of Players	Number of Options	In/Out Single/DBL/Master	Bullseye Single/DBL
G46	Double Down	1-8	1/2	N/A	Yes
G47	Shooting I	1-8	1/2	N/A	Yes
G48	Shooting II	1-8	1/2	N/A	Yes

\*The minimum lives selection must be -3 for these games.

Game Number	Name	Handicap options
G01	301	-20, -40, -60, -80 Score
G02	501	-20, -40, -60, -80 Score
G03	601	-20, -40, -60, -80 Score
G04	701	-20, -40, -60, -80 Score
G05	801	-20, -40, -60, -80 Score
G06	901	-20, -40, -60, -80 Score
G07	301 League	-20, -40, -60, -80 Score
G08	501 League	-20, -40, -60, -80 Score
G09	601 League	-20, -40, -60, -80 Score
G10	701 League	-20, -40, -60, -80 Score
G11	801 League	-20, -40, -60, -80 Score
G12	901 League	-20, -40, -60, -80 Score
G13	Cricket	L1 L2 L3 L4
G14	No Score Cricket	L1 L2 L3 L4
G15	Cut Throat Cricket	L1 L2 L3 L4
G17	Low Pitch Cricket	L1 L2 L3 L4
G20	Single Only Cricket	L1 L2 L3 L4
G21	Double Only Cricket	L1 L2 L3 L4
G22	Triple Only Cricket	L1 L2 L3 L4
G25	Count Up	+20, +40, +60, +80 Score
G26	Light Out	-1, -2, -3, -4 Light
G27	Light Up	-1, -2, -3, -4 Light
G29	Color Shot 2	-1, -2, -3, -4 Mark
G30	Light Off Warfare	-1, -2, -3, -4 Light
G40	Shanghai	+20, +40, +60, +80 Score
G41	Halve-It	+20, +40, +60, +80 Score
G42	Big-6	-1, -2, -3, -4 Lives
G44	Shoot Out	+1, +2, +3, +4 Marks
G45	9 Lives	-1, -2, -3, -4 Lives
G46	Double Down	+20, +40, +60, +80 Score

In/Out Single/Double/Master Options		
If Selecting Option		Then
L01	No icons are lit up	Single In/Single Out
L02	D. IN icon lit up	Double In/Single Out
L03	D.OUT icon lit up	Single In/Double Out
L04	D. IN and D.OUT icons lit up	Double In/Double Out
L05	M. OUT icon lit up	Single In/Master Out (double or triple)
L06	D. IN and M. OUT icons lit up	Double In/Master Out (double or triple)