

NYA-EVO®



GO FURTHER



RCI

(Removable Camera Inserts)

USER GUIDE

- get the most out of your gear -

How Does it Function?

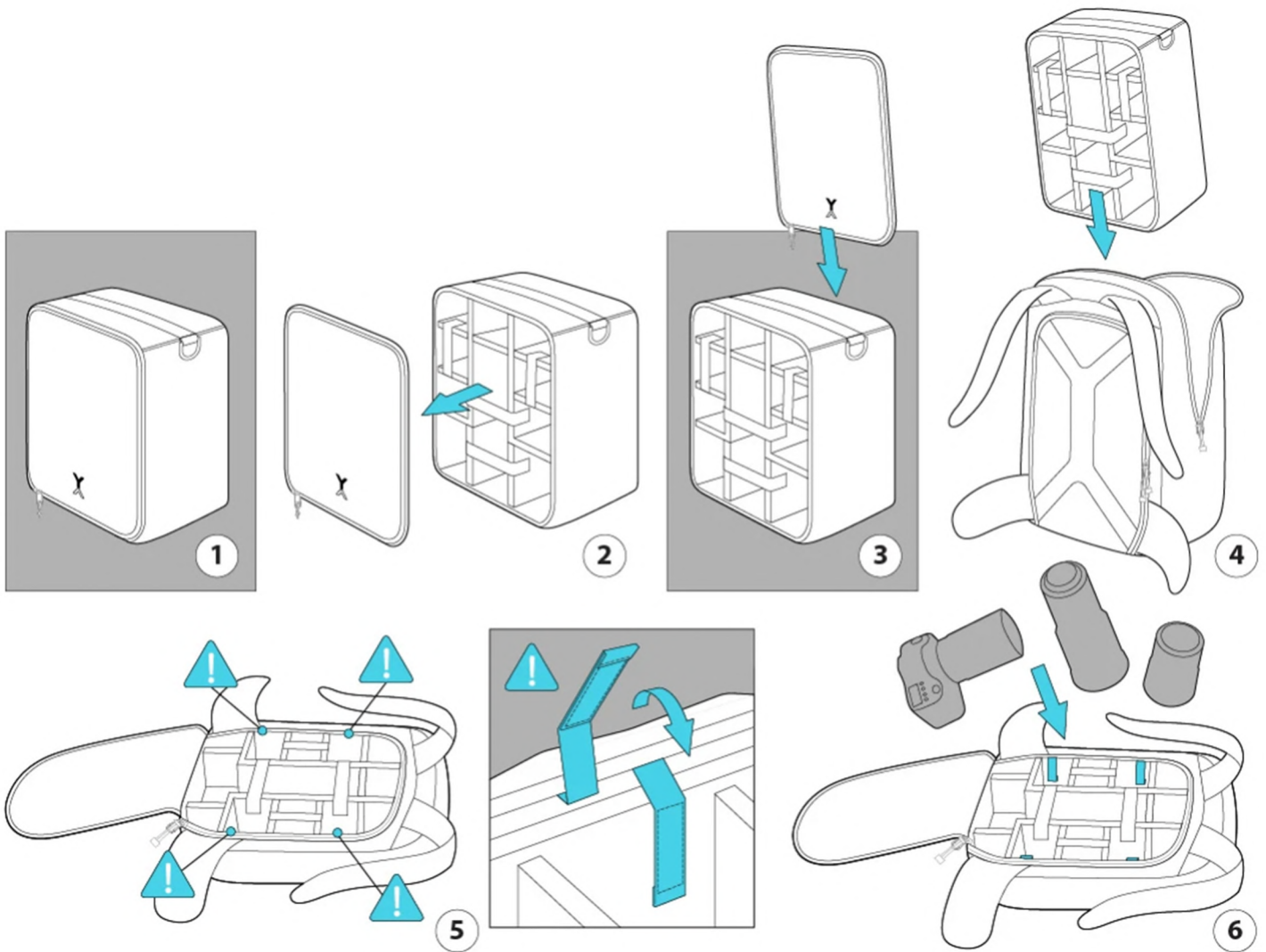

RCI - REMOVABLE CAMERA INSERT

1. It is advised to insert the RCI empty into the backpack.
2. Zip off the front lid of the RCI and detach it completely.
3. Open the top zipper of the backpack. It is important to insert the RCI into the pack from the top zipper and NOT the rear zipper.
4. You can either store the lid between the back of the RCI and backpack to create a new sleeve or leave the zip off lid behind.
5. Retrieve the Velcro® tabs located on the inside of the backpack sewn into the rear panel seams and fix the Velcro® tabs to the inside walls of the RCI. This will secure the RCI to the aluminum frame and prevent it from moving around.
6. Ready to start packing!

How Does it Function?

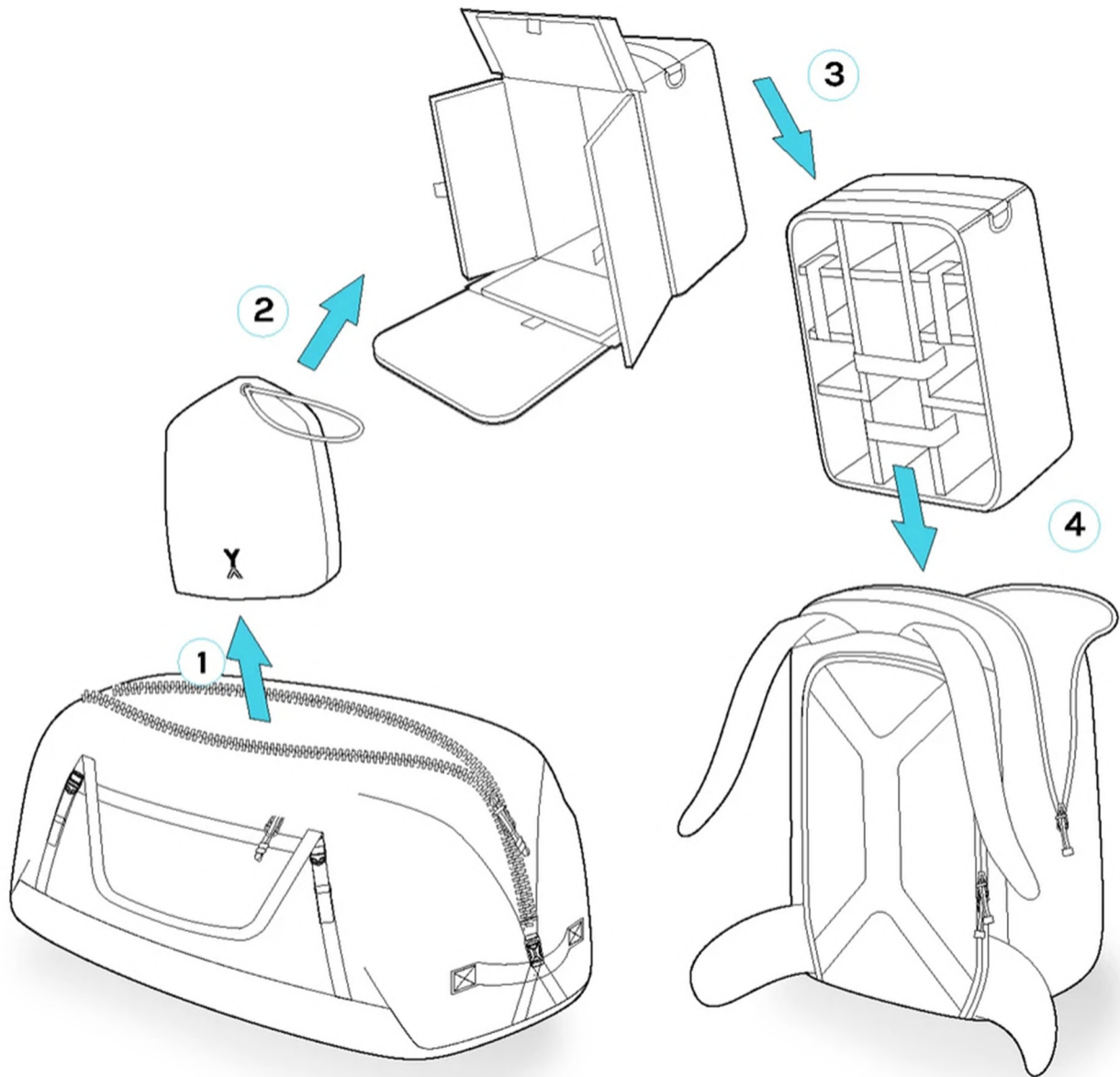

RCI - REMOVABLE CAMERA INSERT

1. Take empty collapsed RCI out of your check-in luggage.
2. Take the RCI out of dust bag.
3. Fold the RCI walls into a box.
4. Slide the RCI inside the backpack and ready to start packing!

What Can Fit?

INTERNAL DIMENSIONS

RCI-S

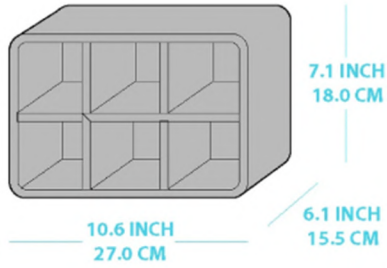

INTERNAL DIMENSIONS

RCI-M

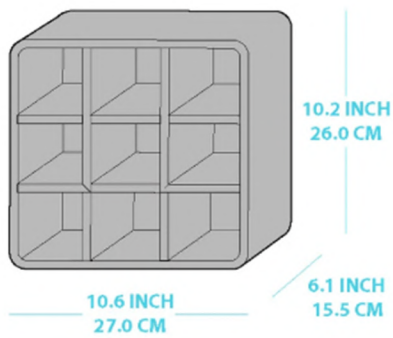

INTERNAL DIMENSIONS

RCI-L

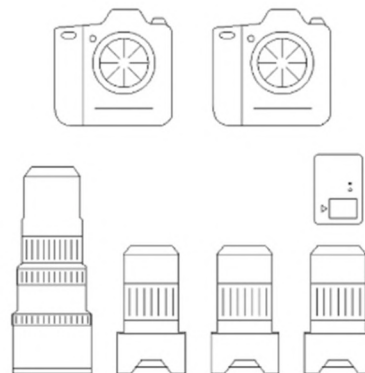
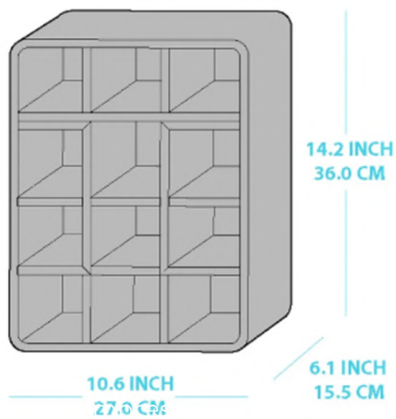

What Can Fit?

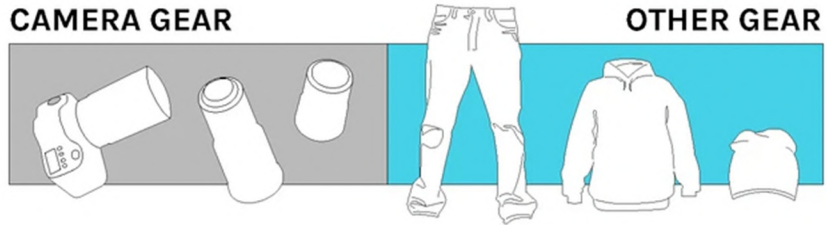

PACK



RCI-S

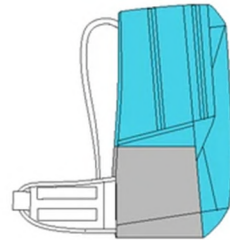
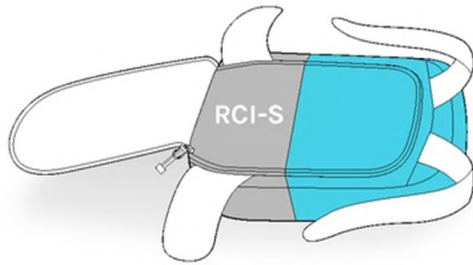

PACK

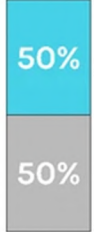

RCI-M

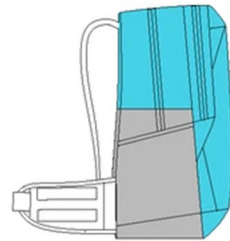
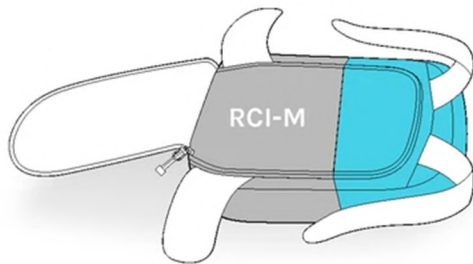

PACK



RCI-L

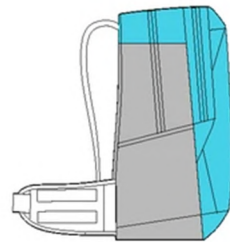
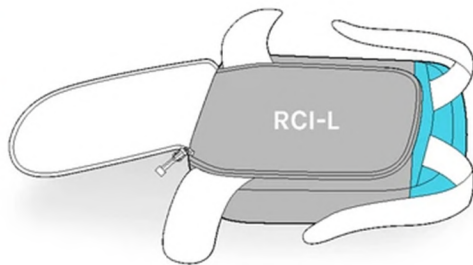

FJORD 36

What Can Fit?

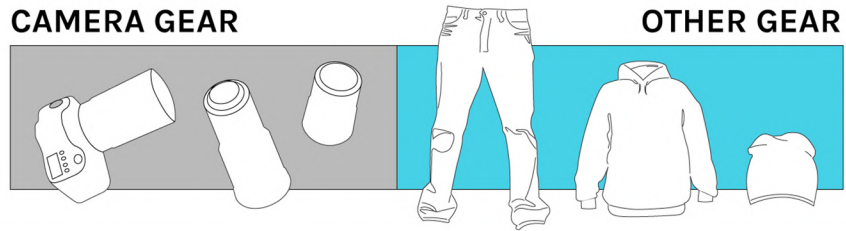

RCI inside Fjord 60-C
(backpack shown not expanded)

FREE
80%
with
bag not
expanded
20%
RCI-S

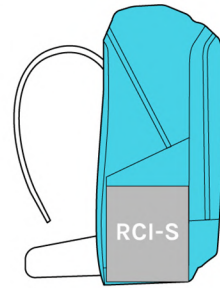
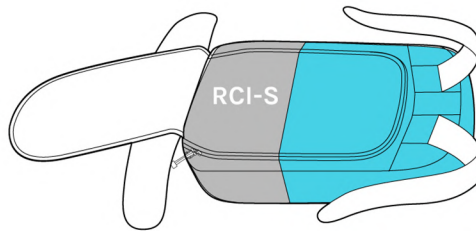

FREE
60%
with
bag not
expanded
40%
RCI-M

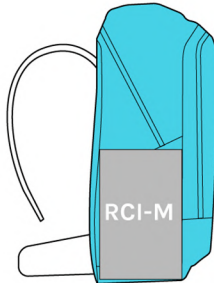
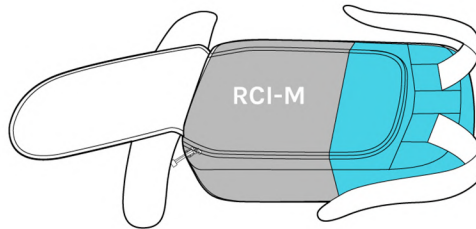

FREE
40%
with
bag not
expanded
60%
RCI-L

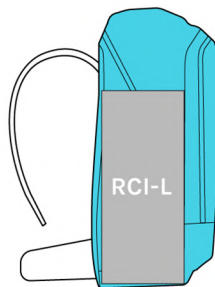
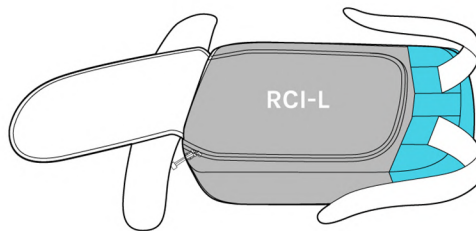

FJORD 60-C