

HALF DICE & FULL DICE

SPIKA MODULAR SERIES MS 500 - MS 1000 ICE CUBE MAKERS



SPIKA MS 500

Daily Production
494 Lbs. / 224 Kg.













SPIKA MS 1000

Daily Production
970 Lbs. / 440 Kg.

All SPIKA models available Half (H) or Full (F) dice. Air (A) or Water (W) cooled

SPIKA MODULAR SERIES MS 500 - MS 1000

Standard Features

- 
NEW WATER DISTRIBUTOR: Increases resistance against scale build up. Easily removable and cleanable.
- 
30" WIDE: Standard width for modular ice makers; fits any 30" wide ice storage bin or dispenser.
- 
LARGER DAILY ICE PRODUCTION: From 494 Lbs./ 224 Kg. to 970 Lbs./ 440 Kg. a day. Both units are "stackable" with staking kit (available separately) to allow increased daily ice production.
- 
DUAL SWITCH: A rear switch allows to turn the machine on/off easily. Removing the front cover we have the ice/wash switch.
- 
EASY CLEANING: Smart plastic design for food zone.
- 
INLET WATER CONNECTION THROUGH EVAPORATOR: Helps to harvest; precools water; assists energy recovery.
- 
EASY ACCESS FOR SERVICE AND INSTALLATION: Designed to have better access to all components making installation and servicing operations easier. One person can disassemble the entire machine with a basic screwdriver.
- 
OPERATING LIMITS: Tropicalized machines (Class T); Suitable for low temperature environments of 41° (5°C) Air and Water and high temperature environments of 109°F (43°C) (Air), 95°F (35°C) (Water) Water pressure: Min. 10 psi. (0.7 bar.)/ Max. 85 psi. (6 bar.). NOTE: Install a pressure reducer if water inlet pressure is more than 85 psi. (6 bar.).
- 
ELECTRICAL SPECIFICATIONS: **MS 500/440:** 115V/60Hz/1. Also available *208-230V/60Hz/1. Plug 5-15P / **MS 1000/880:** 208-230V/60Hz/1. Also available *three phase. Plug 6-15P. (*Special order only. Restrictions may apply. Contact dealer for details.)
- 
MORE ENERGY EFFICIENT: SPIKA Series are Energy Star® qualified machines, reducing water and electricity consumption.
- 
WARRANTY: 36 months parts and labor + 24 additional months parts on compressor and evaporator. Valid in the U.S. and Canada. Contact ITV for warranty in other countries.

SPIKA MODULAR SERIES MS 500 - MS 1000 ICE CUBE MAKERS

Dimensions (Inch./Cm.)

SPIKA	W	D	H
MS 500	30" / 76 cm.	24 3/8" / 62 cm.	19 3/4" / 50 cm.
MS 1000			29 7/8" / 76 cm.

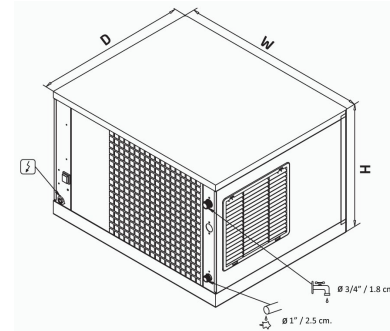

General Specifications

Item #	Model #	Production				Cycle	Water Usage		Kwh/ 100 lbs.	Power W	Amps.	R404A oz.	Net	Filtration Kit (Not included)
		70°F Air/50°F Water		90°F Air/70°F Water			Cubes	gal./hr. / l./ hr.					Weight	
		Lbs./ 24 h.	Kg./ 24 h.	Lbs./ 24 h.	Kg./ 24 h.									
17204	MS 500 A 1 H	494	224	410	186	400	2.80/10.70	6.73	1200	11	19.42	187/85	CS-102 K	
17205	MS 500 W 1 H*	461	209	410	186	400		4.91	1200	11	21.18	187/85		
18204	MS 500 A 1 F	494	224	400	182	200	2.80/10.70	6.48	1200	11	19.42	187/85		
18205	MS 500 W 1 F*	461	209	400	182	200		4.73	1200	11	21.18	187/85		
17202	MS 500 A 2 H	494	224	410	186	400	2.80/10.70	6.7	1200	11	-	187/85		
17203	MS 500 W 2 H*	461	209	410	186	400		4.9	1200	11	-	187/85		
18202	MS 500 A 2 F	494	224	400	182	200	2.80/10.70	6.5	1200	11	-	187/85		
18203	MS 500 W 2 F*	461	209	400	182	200		4.7	1200	11	-	187/85		
17402	MS 1000 A 2 H	970	440	730	331	800	5.40/20.60	5.34	1970	8	33.54	232/105	CS-112 K	
17403	MS 1000 W 2 H*	974	442	915	415	800		3.9	1970	8	-	232/105		
18402	MS 1000 A 2 F	970	440	730	331	400	5.40/20.60	5.4	1970	8	33.54	232/105		
18403	MS 1000 W 2 F*	974	442	915	415	400		3.94	1970	8	-	232/105		
17404	MS 1000 A 3 H	970	440	730	331	800	5.40/20.60	5.3	1970	8	-	232/105		
17405	MS 1000 W 3 H*	974	442	915	415	800		3.9	1970	8	-	232/105		
18404	MS 1000 A 3 F	970	440	730	331	400	5.40/20.60	5.4	1970	8	-	232/105		
18405	MS 1000 W 3 F*	974	442	915	415	400		3.9	1970	8	-	232/105		

A: Air-Cooled / W: Water-Cooled / H: Half Dice / F: Full Dice / 1: 115V/60Hz/1 / 2: 208-230V/60Hz/1 / 3: 208-230V/60Hz/3

*Water cooled units available special order only, restrictions may apply. Please contact your dealer for details.

Shipping Weight: MS 500: 209 Lbs. (95 Kg.) / MS 1000: 278 Lbs. (126 Kg.)

Due to our continuous efforts for improving and developing our range of products, ITV Ice Makers, Inc. reserves the right of changing features with no previous notice.

Ice Shape

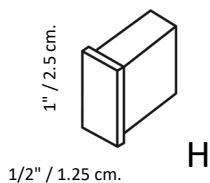

H

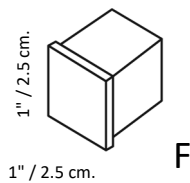

F



HALF DICE & FULL DICE