

# WAVE15-APS, PF

18.7" x 17.2" x 9.7"  
(47.5cm x 43.7cm x 24.6cm)



- BrewMETER® allows automatic programming of pulse routine
- Adjustable legs to accommodate up to 3.0L lever action and 2.5L push button BUNN airpots and thermal servers
- Brew into 1.9L thermal carafe using the slide-out booster tray
- Four-digit LED read-out for simple programming
- Utilize the same LED read-out for brewer status (Ready, Heating, Brewing)
- SmartWAVE technology increases turbulence in the brew funnel
- Standard Version
- Energy-saver mode reduces tank temperature during idle periods
- Ensures coffee brew quality with cold brew lock out capability
- SplashGard® funnel deflects hot liquids away from the hand

Agency:

## Specifications

**Product #:** 39900.6005

**Water Access:** Plumbed

**Finish:** Stainless

**Funnel:** Black Plastic

**Faucet:** Lower

## Additional Features

Standard Series

BrewMETER

## Electrical & Capacity

Volts	Amps	Watts	Cord Attached	Plug Type	8oz cups/hr 236ml cups/hr	Input H <sup>2</sup> O Temp.	Phase	# Wires plus Ground	Hertz
-	-	-	-	-	62	60°F (15.5°C)	-	-	-

## Plumbing Requirements

PSI	kPa	Fitting Supplied	Water Flow Required (GPM)
20-90	138-621	1/4" Male Flare Fitting	-

## CAD Drawings

2D	Revit	KLC
●		



BUNN® reserves the right to change specifications and product design without notice. Such revisions do not entitle the buyer to corresponding changes, improvements, additions or replacements for previously purchased equipment. For most current specifications and other info visit [bunn.com](http://bunn.com).

Created on:  
05/09/2018

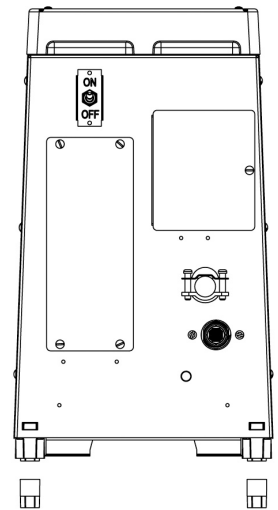
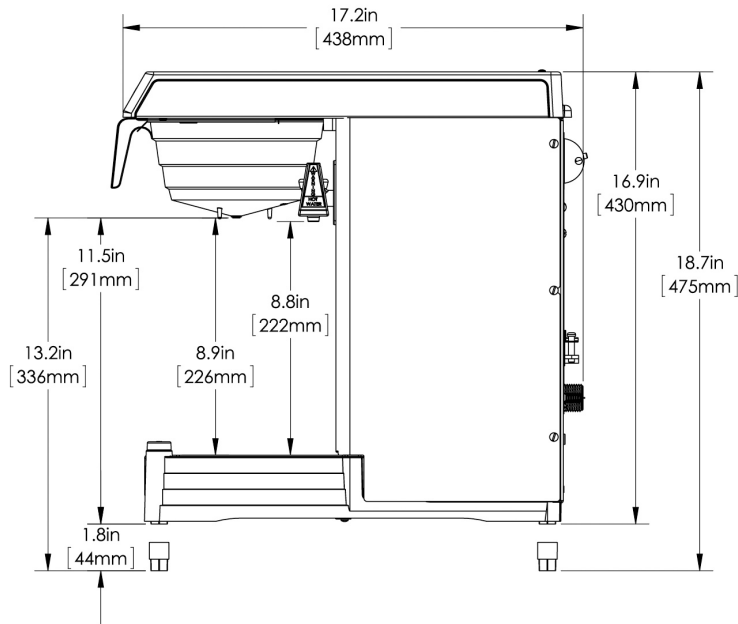
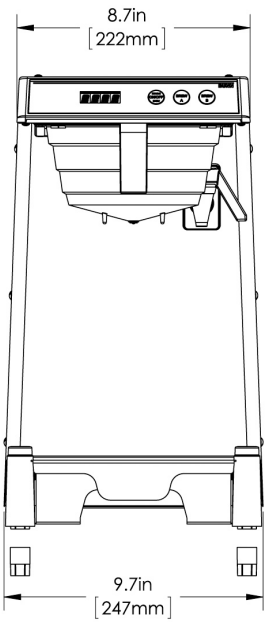
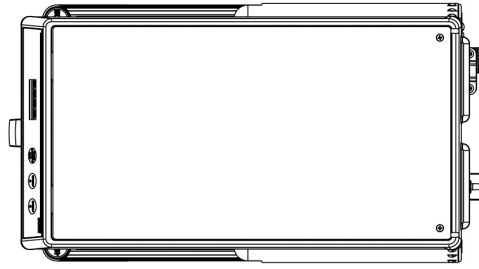

	Unit			Shipping				
	Width	Height	Depth	Width	Height	Depth	Weight	Volume
English	9.7 in.	18.7 in.	17.2 in.	- in.	- in.	- in.	-	-
Metric	24.6 cm	47.5 cm	43.7 cm	- cm	- cm	- cm	-	-



BUNN® reserves the right to change specifications and product design without notice. Such revisions do not entitle the buyer to corresponding changes, improvements, additions or replacements for previously purchased equipment. For most current specifications and other info visit [bunn.com](http://bunn.com).

Created on:  
05/09/2018

Related Products & Accessories:WAVE15-APS, PF(39900.6005)



FILTERS,REG/1M

Product #: 20115.6000



FUNNEL W/DECALS,  
BLACK PLASTIC

Product #: 20583.0003



WATER FILTER  
SYSTEM,EQ-17-TL

Product #: 30200.1000



WATER FILTER,IN LINE  
ED-17-TL



















Product #: 30201.1001



BUNN® reserves the right to change specifications and product design without notice. Such revisions do not entitle the buyer to corresponding changes, improvements, additions or replacements for previously purchased equipment. For most current specifications and other info visit [bunn.com](http://bunn.com).

Created on:  
05/09/2018

# Serving & Holding Options: WAVE15-APS, PF(39900.6005)

 <p>AIRPOT, 2.5L GL PB SINGLE PK</p> <p>Product #:13041.0001</p>	 <p>AIRPOT, 2.5L GL PB 6/ CASE</p> <p>Product #:13041.0101</p>	 <p>ACC,2.5 LITRE AIRPOT BLACK</p> <p>Product #:13041.6000</p>	 <p>TSR-1, THERMAL SRVR RACK-1 POSN</p> <p>Product #:18008.6001</p>	 <p>ACC, 1.9L THERMAL CARAFE SST</p> <p>Product #:18022.6002</p>
 <p>AIRPOT, 2.2L GL PB SINGLE PK</p> <p>Product #:28696.0002</p>	<p>NO IMAGE AVAILABLE</p> <p>AIRPOT, 2.2L GL PB 6/ CASE</p> <p>Product #:28696.0006</p>	 <p>ACC, AIRPOT 2.2 LITRE SINGLE PACK</p> <p>Product #:28696.6000</p>	 <p>AIRPOT, 2.5L SST LA SINGLE PK</p> <p>Product #:32125.0000</p>	 <p>AIRPOT, 2.5L SST LA 6/ CASE</p> <p>Product #:32125.0100</p>
 <p>AIRPOT, 3.0L SST LA SINGLE PK</p> <p>Product #:32130.0000</p>	 <p>AIRPOT, 3.0L SST LA 6/ CASE</p> <p>Product #:32130.0100</p>	 <p>THERMAL CARAFE, BLK 1.9L 1PK</p> <p>Product #:36029.0001</p>	 <p>THERMAL CARAFE, ORN 1.9L 12PK</p> <p>Product #:36252.0000</p>	 <p>THERMAL CARAFE, ORN 1.9L 1PK</p> <p>Product #:36252.0001</p>
 <p>PITCHER, SST 1.9L TALL- SNGL PK</p> <p>Product #:39430.0000</p>	 <p>PITCHER, SST 1.9L TALL- 6/CASE</p> <p>Product #:39430.0100</p>	 <p>CARAFE, SST 1.9L SHRT BLK 1/</p> <p>Product #:40163.0000</p>	 <p>CARAFE, SST 1.9L SHRT ORN 1/</p> <p>Product #:40163.0001</p>	 <p>CARAFE, SST 1.9L SHRT BLK 12/</p> <p>Product #:40163.0100</p>



BUNN® reserves the right to change specifications and product design without notice. Such revisions do not entitle the buyer to corresponding changes, improvements, additions or replacements for previously purchased equipment. For most current specifications and other info visit [bunn.com](http://bunn.com).

Created on:  
05/09/2018



# Serving & Holding Options: WAVE15-APS, PF(39900.6005)



CARAFE, SST 1.9L SHRT  
ORN 12/

Product #:40163.0101

NO IMAGE  
AVAILABLE

THERMAL SRVR, 2.5L 6/  
CS NO BASE GL LINR

Product #:45882.0001



THERMAL SRVR, 2.5L  
NO BASE GL LINER

Product #:45882.0003



BUNN® reserves the right to change specifications and product design without notice. Such revisions do not entitle the buyer to corresponding changes, improvements, additions or replacements for previously purchased equipment. For most current specifications and other info visit [bunn.com](http://bunn.com).

Created on:  
05/09/2018

# WAVE15-S-APS, PF

18.7" x 17.2" x 9.7"  
(47.5cm x 43.7cm x 24.6cm)



- BrewMETER® allows automatic programming of pulse routine
- Adjustable legs to accommodate up to 3.0L lever action and 2.5L push button BUNN airpots and thermal servers
- Analog switches accompanied by red/green LED for programming
- Brew into 1.9L thermal carafe using the slide-out booster tray
- Choice of three pulse brew routines to adjust your flavor profile
- Red/green LED provide brewer status (ready, heating, brewing)
- SmartWAVE technology increases turbulence in the brew funnel
- Silver Version
- Energy-saver mode reduces tank temperature during idle periods
- Ensures coffee brew quality with cold brew lock out capability
- SplashGard® funnel deflects hot liquids away from the hand

Agency:

## Specifications

**Product #:** 39900.6006

**Water Access:** Plumbed

**Finish:** Stainless

**Funnel:** Black Plastic

**Faucet:** Lower

## Additional Features

Silver Series

## Electrical & Capacity

Volts	Amps	Watts	Cord Attached	Plug Type	8oz cups/hr 236ml cups/hr	Input H <sub>2</sub> O Temp.	Phase	# Wires plus Ground	Hertz
-	-	-	-	-	62	60°F (15.5°C)	-	-	-

## Plumbing Requirements

PSI	kPa	Fitting Supplied	Water Flow Required (GPM)
20-90	138-621	1/4" Male Flare Fitting	-

## CAD Drawings

2D	Revit	KLC
●		



BUNN® reserves the right to change specifications and product design without notice. Such revisions do not entitle the buyer to corresponding changes, improvements, additions or replacements for previously purchased equipment. For most current specifications and other info visit [bunn.com](http://bunn.com).

Created on:  
05/09/2018

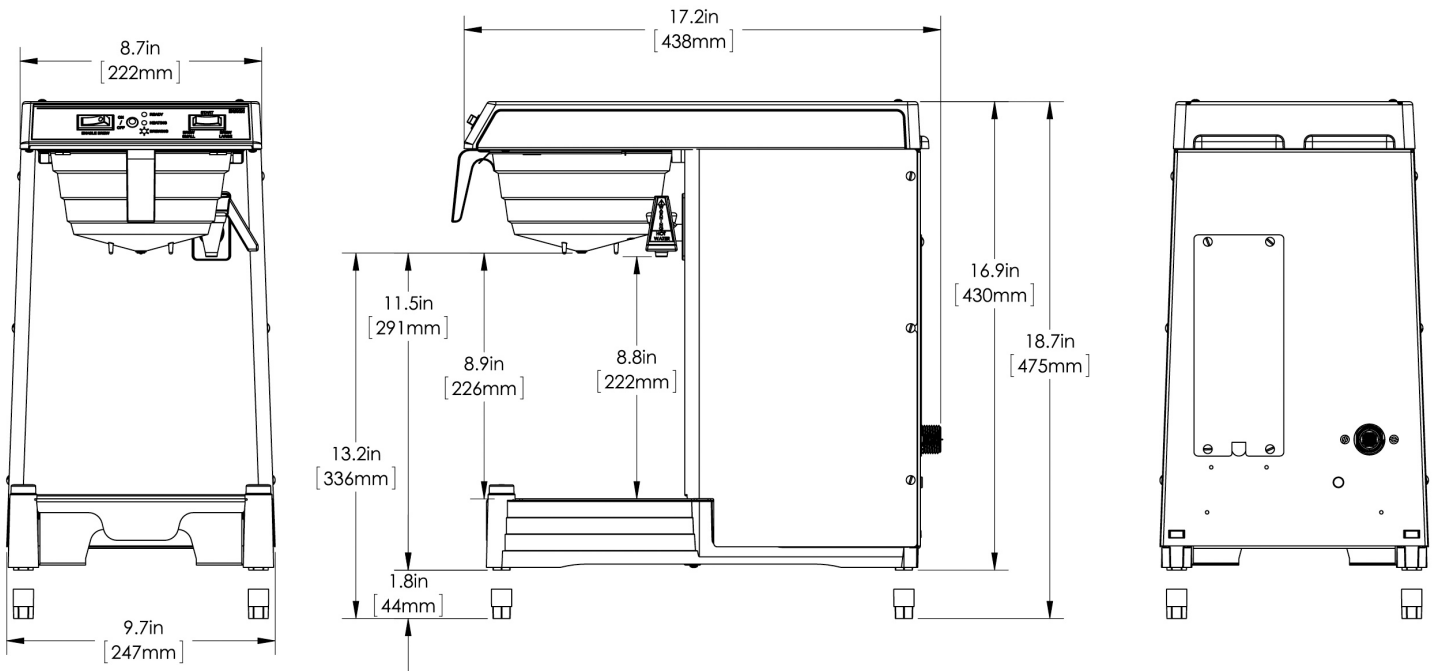
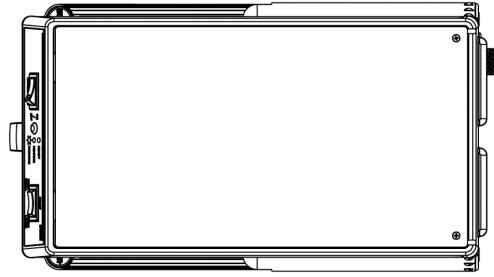

	Unit			Shipping				
	Width	Height	Depth	Width	Height	Depth	Weight	Volume
English	9.7 in.	18.7 in.	17.2 in.	- in.	- in.	- in.	-	-
Metric	24.6 cm	47.5 cm	43.7 cm	- cm	- cm	- cm	-	-



BUNN® reserves the right to change specifications and product design without notice. Such revisions do not entitle the buyer to corresponding changes, improvements, additions or replacements for previously purchased equipment. For most current specifications and other info visit [bunn.com](http://bunn.com).

Created on:  
05/09/2018

Related Products & Accessories:WAVE15-S-APS, PF(39900.6006)



FILTERS,REG/1M

Product #: 20115.6000



FUNNEL W/DECALS,  
BLACK PLASTIC

Product #: 20583.0003



WATER FILTER  
SYSTEM,EQ-17-TL

Product #: 30200.1000



WATER FILTER,IN LINE  
ED-17-TL

Product #: 30201.1001



BUNN® reserves the right to change specifications and product design without notice. Such revisions do not entitle the buyer to corresponding changes, improvements, additions or replacements for previously purchased equipment. For most current specifications and other info visit [bunn.com](http://bunn.com).

Created on:  
05/09/2018

# Serving & Holding Options: WAVE15-S-APS, PF(39900.6006)



AIRPOT, 2.5L GL PB  
SINGLE PK

Product #:13041.0001



AIRPOT, 2.5L GL PB 6/  
CASE

Product #:13041.0101



ACC,2.5 LITRE AIRPOT  
BLACK

Product #:13041.6000



TSR-1, THERMAL SRVR  
RACK-1 POSN

Product #:18008.6001



ACC, 1.9L THERMAL  
CARAFE SST

Product #:18022.6002



AIRPOT, 2.2L GL PB  
SINGLE PK

Product #:28696.0002

NO IMAGE  
AVAILABLE

AIRPOT, 2.2L GL PB 6/  
CASE

Product #:28696.0006



ACC, AIRPOT 2.2 LITRE  
SINGLE PACK

Product #:28696.6000



AIRPOT, 2.5L SST LA  
SINGLE PK

Product #:32125.0000



AIRPOT, 2.5L SST LA 6/  
CASE

Product #:32125.0100



AIRPOT, 3.0L SST LA  
SINGLE PK

Product #:32130.0000



AIRPOT, 3.0L SST LA 6/  
CASE

Product #:32130.0100



THERMAL CARAFE, BLK  
1.9L 1PK

Product #:36029.0001



THERMAL CARAFE, ORN  
1.9L 12PK

Product #:36252.0000



THERMAL CARAFE, ORN  
1.9L 1PK

Product #:36252.0001



PITCHER, SST 1.9L TALL-  
SNGL PK

Product #:39430.0000



PITCHER, SST 1.9L  
TALL-6/CASE

Product #:39430.0100



CARAFE, SST 1.9L SHRT  
BLK 1/

Product #:40163.0000



CARAFE, SST 1.9L SHRT  
ORN 1/

Product #:40163.0001



CARAFE, SST 1.9L SHRT  
BLK 12/

Product #:40163.0100



BUNN® reserves the right to change specifications and product design without notice. Such revisions do not entitle the buyer to corresponding changes, improvements, additions or replacements for previously purchased equipment. For most current specifications and other info visit [bunn.com](http://bunn.com).

Created on:  
05/09/2018

# Serving & Holding Options: WAVE15-S-APS, PF(39900.6006)



CARAFE, SST 1.9L SHRT  
ORN 12/

Product #:40163.0101

NO IMAGE  
AVAILABLE

THERMAL SRVR, 2.5L 6/  
CS NO BASE GL LINR

Product #:45882.0001



THERMAL SRVR, 2.5L  
NO BASE GL LINER

Product #:45882.0003



BUNN® reserves the right to change specifications and product design without notice. Such revisions do not entitle the buyer to corresponding changes, improvements, additions or replacements for previously purchased equipment. For most current specifications and other info visit [bunn.com](http://bunn.com).

Created on:  
05/09/2018

# WAVE-APS, PF

18.7" x 17.2" x 9.7"  
(47.5cm x 43.7cm x 24.6cm)



- BrewMETER® allows automatic programming of pulse routine
- Adjustable legs to accommodate up to 3.0L lever action and 2.5L push button BUNN airpots and thermal servers
- Brew into 1.9L thermal carafe using the slide-out booster tray
- Four-digit LED read-out for simple programming
- Utilize the same LED read-out for brewer status (Ready, Heating, Brewing)
- SmartWAVE technology increases turbulence in the brew funnel
- Standard Version
- Energy-saver mode reduces tank temperature during idle periods
- Ensures coffee brew quality with cold brew lock out capability
- SplashGard® funnel deflects hot liquids away from the hand

Agency:

## Specifications

**Product #:** 39900.6008

**Water Access:** Plumbed

**Finish:** Stainless

**Funnel:** Black Plastic

**Faucet:** Lower

## Additional Features

Standard Series

BrewMETER

## Electrical & Capacity

Volts	Amps	Watts	Cord Attached	Plug Type	8oz cups/hr 236ml cups/hr	Input H <sup>2</sup> O Temp.	Phase	# Wires plus Ground	Hertz
-	-	-	-	-	102	60°F (15.5°C)	-	-	-

## Plumbing Requirements

PSI	kPa	Fitting Supplied	Water Flow Required (GPM)
20-90	138-621	1/4" Male Flare Fitting	-

## CAD Drawings

2D	Revit	KLC
●		



BUNN® reserves the right to change specifications and product design without notice. Such revisions do not entitle the buyer to corresponding changes, improvements, additions or replacements for previously purchased equipment. For most current specifications and other info visit [bunn.com](http://bunn.com).

Created on:  
05/09/2018

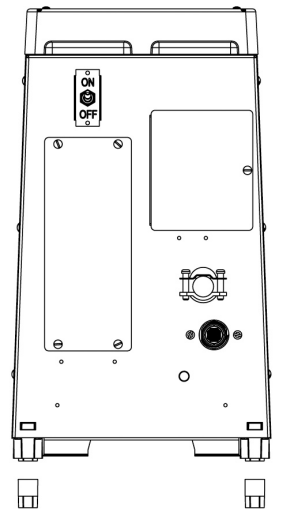
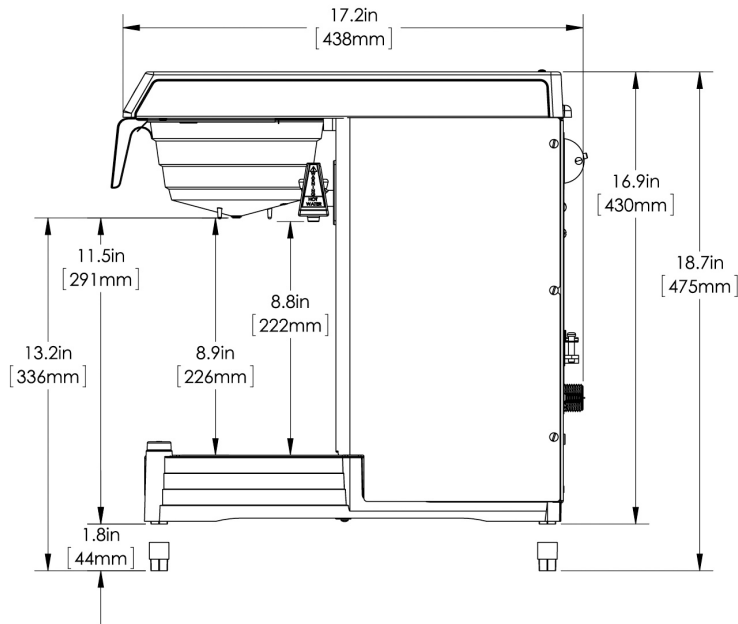
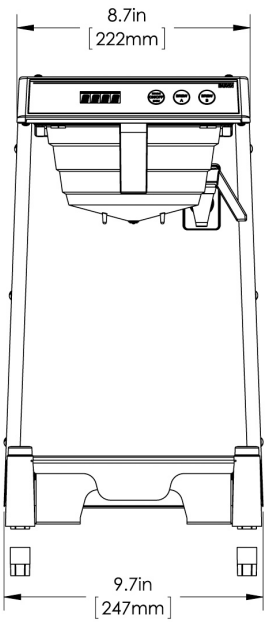
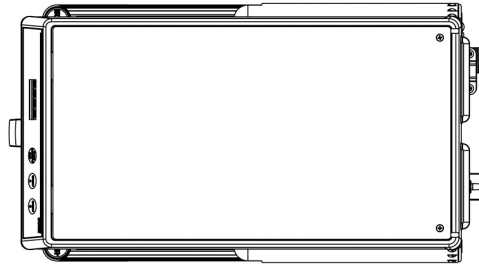

	Unit			Shipping				
	Width	Height	Depth	Width	Height	Depth	Weight	Volume
English	9.7 in.	18.7 in.	17.2 in.	- in.	- in.	- in.	-	-
Metric	24.6 cm	47.5 cm	43.7 cm	- cm	- cm	- cm	-	-



BUNN® reserves the right to change specifications and product design without notice. Such revisions do not entitle the buyer to corresponding changes, improvements, additions or replacements for previously purchased equipment. For most current specifications and other info visit [bunn.com](http://bunn.com).

Created on:  
05/09/2018



Related Products & Accessories:WAVE-APS, PF(39900.6008)



FILTERS,REG/1M

Product #: 20115.6000



FUNNEL W/DECALS,  
BLACK PLASTIC

Product #: 20583.0003



WATER FILTER  
SYSTEM,EQ-17-TL

Product #: 30200.1000



WATER FILTER,IN LINE  
ED-17-TL

Product #: 30201.1001



BUNN® reserves the right to change specifications and product design without notice. Such revisions do not entitle the buyer to corresponding changes, improvements, additions or replacements for previously purchased equipment. For most current specifications and other info visit [bunn.com](http://bunn.com).

Created on:  
05/09/2018

# Serving & Holding Options: WAVE-APS, PF(39900.6008)



AIRPOT, 2.5L GL PB  
SINGLE PK

Product #:13041.0001



AIRPOT, 2.5L GL PB 6/  
CASE

Product #:13041.0101



ACC,2.5 LITRE AIRPOT  
BLACK

Product #:13041.6000



TSR-1, THERMAL SRVR  
RACK-1 POSN

Product #:18008.6001



ACC, 1.9L THERMAL  
CARAFE SST

Product #:18022.6002



AIRPOT, 2.2L GL PB  
SINGLE PK

Product #:28696.0002

NO IMAGE  
AVAILABLE

AIRPOT, 2.2L GL PB 6/  
CASE

Product #:28696.0006



ACC, AIRPOT 2.2 LITRE  
SINGLE PACK

Product #:28696.6000



AIRPOT, 2.5L SST LA  
SINGLE PK

Product #:32125.0000



AIRPOT, 2.5L SST LA 6/  
CASE

Product #:32125.0100



AIRPOT, 3.0L SST LA  
SINGLE PK

Product #:32130.0000



AIRPOT, 3.0L SST LA 6/  
CASE

Product #:32130.0100



THERMAL CARAFE, BLK  
1.9L 1PK

Product #:36029.0001



THERMAL CARAFE, ORN  
1.9L 12PK

Product #:36252.0000



THERMAL CARAFE, ORN  
1.9L 1PK

Product #:36252.0001



PITCHER, SST 1.9L TALL-  
SNGL PK

Product #:39430.0000



PITCHER, SST 1.9L  
TALL-6/CASE

Product #:39430.0100



CARAFE, SST 1.9L SHRT  
BLK 1/

Product #:40163.0000



CARAFE, SST 1.9L SHRT  
ORN 1/

Product #:40163.0001



CARAFE, SST 1.9L SHRT  
BLK 12/

Product #:40163.0100



BUNN® reserves the right to change specifications and product design without notice. Such revisions do not entitle the buyer to corresponding changes, improvements, additions or replacements for previously purchased equipment. For most current specifications and other info visit [bunn.com](http://bunn.com).

Created on:  
05/09/2018

# Serving & Holding Options: WAVE-APS, PF(39900.6008)



CARAFE, SST 1.9L SHRT  
ORN 12/

Product #:40163.0101

NO IMAGE  
AVAILABLE

THERMAL SRVR, 2.5L 6/  
CS NO BASE GL LINR

Product #:45882.0001



THERMAL SRVR, 2.5L  
NO BASE GL LINER

Product #:45882.0003



BUNN® reserves the right to change specifications and product design without notice. Such revisions do not entitle the buyer to corresponding changes, improvements, additions or replacements for previously purchased equipment. For most current specifications and other info visit [bunn.com](http://bunn.com).

Created on:  
05/09/2018

# WAVE-S-APS, PF

18.7" x 17.2" x 9.7"  
(47.5cm x 43.7cm x 24.6cm)



- BrewMETER® allows automatic programming of pulse routine
- Adjustable legs to accommodate up to 3.0L lever action and 2.5L push button BUNN airpots and thermal servers
- Analog switches accompanied by red/green LED for programming
- Brew into 1.9L thermal carafe using the slide-out booster tray
- Choice of three pulse brew routines to adjust your flavor profile
- Red/green LED provide brewer status (ready, heating, brewing)
- SmartWAVE technology increases turbulence in the brew funnel
- Silver Version
- Energy-saver mode reduces tank temperature during idle periods
- Ensures coffee brew quality with cold brew lock out capability
- SplashGard® funnel deflects hot liquids away from the hand

Agency:

## Specifications

**Product #:** 39900.6009

**Water Access:** Plumbed

**Finish:** Stainless

**Funnel:** Black Plastic

**Faucet:** Lower

## Additional Features

Silver Series

## Electrical & Capacity

Volts	Amps	Watts	Cord Attached	Plug Type	8oz cups/hr 236ml cups/hr	Input H <sub>2</sub> O Temp.	Phase	# Wires plus Ground	Hertz
-	-	-	-	-	102	60°F (15.5°C)	-	-	-

## Plumbing Requirements

PSI	kPa	Fitting Supplied	Water Flow Required (GPM)
20-90	138-621	1/4" Male Flare Fitting	-

## CAD Drawings

2D	Revit	KLC
●		



BUNN® reserves the right to change specifications and product design without notice. Such revisions do not entitle the buyer to corresponding changes, improvements, additions or replacements for previously purchased equipment. For most current specifications and other info visit [bunn.com](http://bunn.com).

Created on:  
05/09/2018

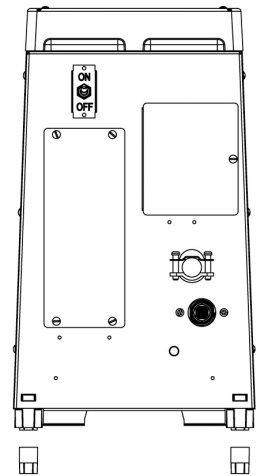
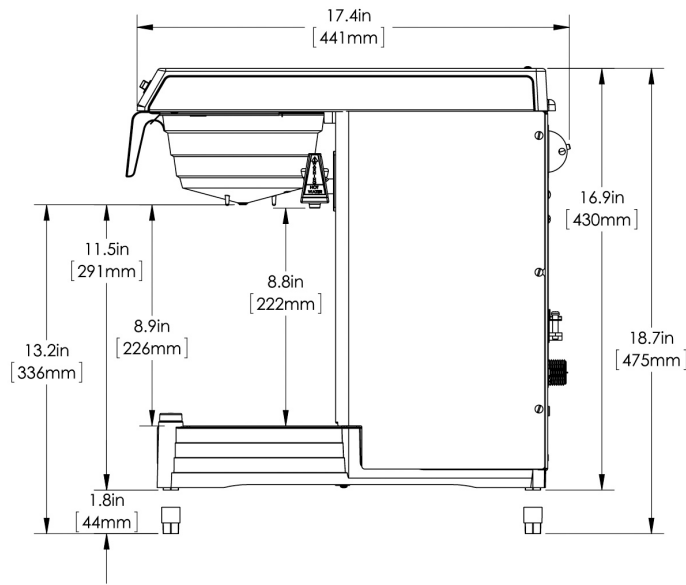
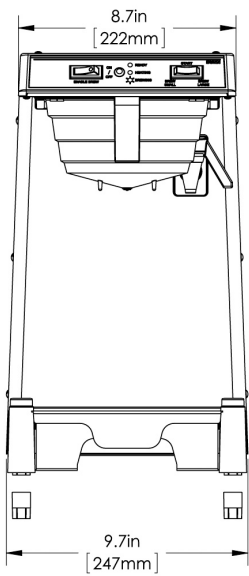
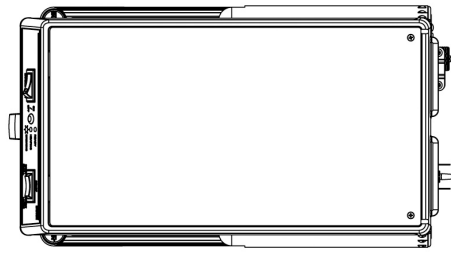

Unit			Shipping					
	Width	Height	Depth	Width	Height	Depth	Weight	Volume
English	9.7 in.	18.7 in.	17.2 in.	- in.	- in.	- in.	-	-
Metric	24.6 cm	47.5 cm	43.7 cm	- cm	- cm	- cm	-	-



BUNN® reserves the right to change specifications and product design without notice. Such revisions do not entitle the buyer to corresponding changes, improvements, additions or replacements for previously purchased equipment. For most current specifications and other info visit [bunn.com](http://bunn.com).

Created on:  
05/09/2018

Related Products & Accessories:WAVE-S-APS, PF(39900.6009)



FILTERS,REG/1M

Product #: 20115.6000



FUNNEL W/DECALS,  
BLACK PLASTIC

Product #: 20583.0003



WATER FILTER  
SYSTEM,EQ-17-TL

Product #: 30200.1000



WATER FILTER,IN LINE  
ED-17-TL

Product #: 30201.1001



BUNN® reserves the right to change specifications and product design without notice. Such revisions do not entitle the buyer to corresponding changes, improvements, additions or replacements for previously purchased equipment. For most current specifications and other info visit [bunn.com](http://bunn.com).

Created on:  
05/09/2018

# Serving & Holding Options: WAVE-S-APS, PF(39900.6009)



AIRPOT, 2.5L GL PB  
SINGLE PK

Product #:13041.0001



AIRPOT, 2.5L GL PB 6/  
CASE

Product #:13041.0101



ACC,2.5 LITRE AIRPOT  
BLACK

Product #:13041.6000



TSR-1, THERMAL SRVR  
RACK-1 POSN

Product #:18008.6001



ACC, 1.9L THERMAL  
CARAFE SST

Product #:18022.6002



AIRPOT, 2.2L GL PB  
SINGLE PK

Product #:28696.0002

NO IMAGE  
AVAILABLE

AIRPOT, 2.2L GL PB 6/  
CASE

Product #:28696.0006



ACC, AIRPOT 2.2 LITRE  
SINGLE PACK

Product #:28696.6000



AIRPOT, 2.5L SST LA  
SINGLE PK

Product #:32125.0000



AIRPOT, 2.5L SST LA 6/  
CASE

Product #:32125.0100



AIRPOT, 3.0L SST LA  
SINGLE PK

Product #:32130.0000



AIRPOT, 3.0L SST LA 6/  
CASE

Product #:32130.0100



THERMAL CARAFE, BLK  
1.9L 1PK

Product #:36029.0001



THERMAL CARAFE, ORN  
1.9L 12PK

Product #:36252.0000



THERMAL CARAFE, ORN  
1.9L 1PK

Product #:36252.0001



PITCHER, SST 1.9L TALL-  
SNGL PK

Product #:39430.0000



PITCHER, SST 1.9L  
TALL-6/CASE

Product #:39430.0100



CARAFE, SST 1.9L SHRT  
BLK 1/

Product #:40163.0000



CARAFE, SST 1.9L SHRT  
ORN 1/

Product #:40163.0001



CARAFE, SST 1.9L SHRT  
BLK 12/

Product #:40163.0100



BUNN® reserves the right to change specifications and product design without notice. Such revisions do not entitle the buyer to corresponding changes, improvements, additions or replacements for previously purchased equipment. For most current specifications and other info visit [bunn.com](http://bunn.com).

Created on:  
05/09/2018

## Serving & Holding Options: WAVE-S-APS, PF(39900.6009)



CARAFE, SST 1.9L SHRT  
ORN 12/

Product #:40163.0101

NO IMAGE  
AVAILABLE

THERMAL SRVR, 2.5L 6/  
CS NO BASE GL LINR

Product #:45882.0001



THERMAL SRVR, 2.5L  
NO BASE GL LINER

Product #:45882.0003



BUNN® reserves the right to change specifications and product design without notice. Such revisions do not entitle the buyer to corresponding changes, improvements, additions or replacements for previously purchased equipment. For most current specifications and other info visit [bunn.com](http://bunn.com).

Created on:  
05/09/2018