

NE-SCV2NAPR COMMERCIAL HIGH-SPEED OVEN

**FOOD SERVICE
EQUIPMENT**www.panasonic.com/CMO

PATENTED TECHNOLOGY FOR RAPID COOKING

A variety of heating patterns offer quick, tasty, fresh results — utilizing Panasonic patented technology to create 6 different heating patterns using 3 functions (Convection, Broil and Microwave).

COMPACT AND STACKABLE*

*requires Joint Plates

This powerful oven is designed for kitchens where space is at a premium. Dimensions: W 18.66 in. x D 22.24 in. x H 16.22 in.

INTERIOR

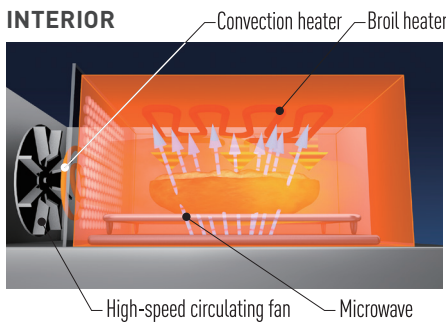

- 3-step continuous heat setting is possible
- Combining Convection, Broil and Microwave functions for speedy heating of frozen, refrigerated, or room temperature dishes
- Fan speed adjustable from 30 to 100%

TYPICAL APPLICATIONS

Category	Product	Start Temp.	Quantity / Size	Time
Sandwich	Breakfast sandwich	Refrigerated	1 pc	1m 10s
Pastry	Croissant	Room temp.	1 pc	23s
Pastry	Muffin	Room temp.	1 pc	25s
Pizza	Pizza	Frozen	9 in	3m
Appetizers	Chicken Fingers	Frozen	4 pcs	1m 30s
Appetizers	Mozzarella Sticks	Frozen	4 pcs	40s
Appetizers	Quiche	Frozen	1 pc	2m 15s

FEATURES

STRUCTURE

DURABILITY

- 400,000 times door open/close testing
- Durable Stainless Steel body

MAIN

- Lightweight door
- Stackable (requires Joint plate #A11343G80BP)

SAFETY

- Auto Heater OFF function

EASE OF USE

- 3-Stage Cooking with Microwave, Convection & Broil functions
- Easy to see, easy to operate with color LCD touch panel
- 1000 recipe memory
- Easy to edit your own menu from either product or PC

SERVICE & MAINTENANCE

SERVICE

- Warranty: 1 year parts and labor
- Easy maintenance w/accessible parts

MAINTENANCE

- Removable air filtration
- Removable rack and ceramic plate, etc.
- Easy-clean enamel door

EFFICIENCY

SET UP

- Ventless cooking by catalytic converter to eliminate odors and emissions
- Automatic voltage detection (208/240V), 20A, Single Phase, NEMA 6-20

ECONOMICAL

- Auto Power OFF Function

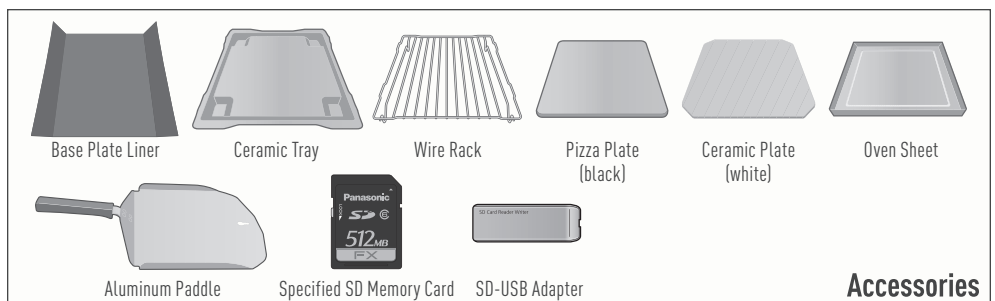
**Accessories**

NE-SCV2NAPR COMMERCIAL HIGH-SPEED OVEN

Combine Convection, Broil and Microwave functions into 6 versatile heating patterns for frozen, refrigerated and room-temperature dishes.

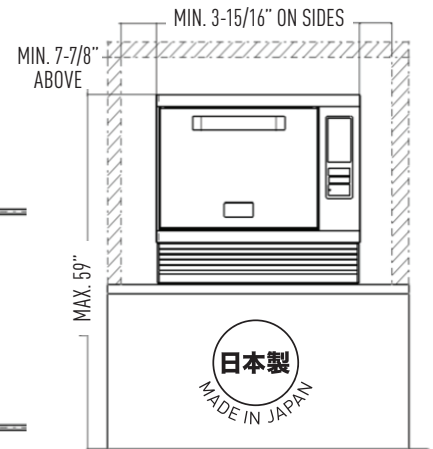
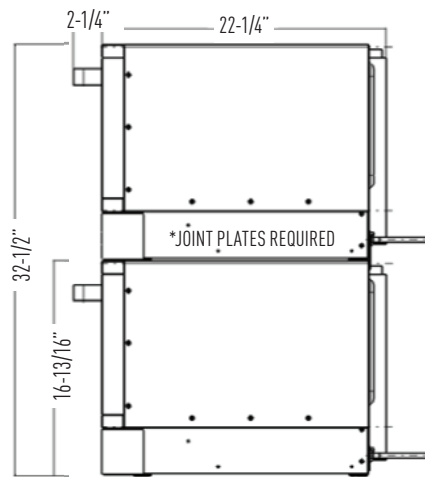
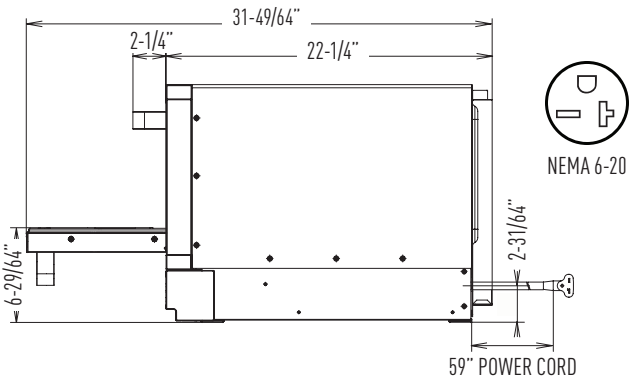
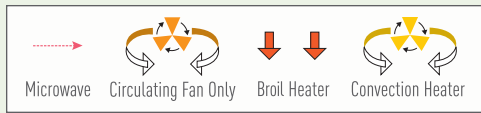
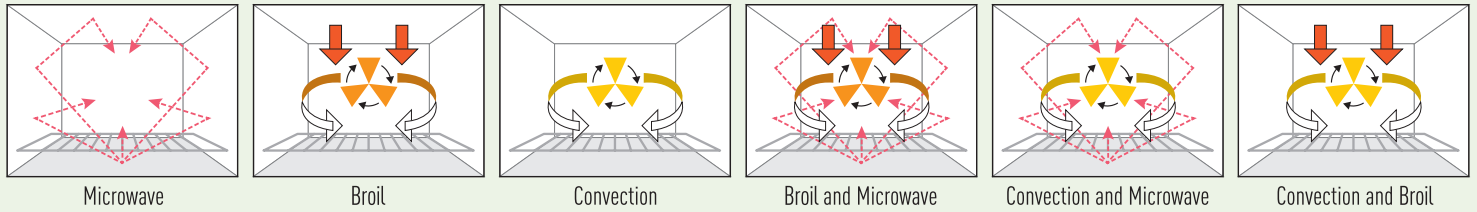

Specifications

Model	NE-SCV2N
Power Source	208/240 V, 60 Hz, Single phase
Plug, Outlet	NEMA 6-20, 20A
Power Requirement	3750W 19A(208V) 17A(240V)
Power Supply	Inverter power supply
Cord Length	5 ft.
Outer Dimensions (WxDxH)	18-11/16 x 22-1/4 x 16-3/16 inch
Oven Dimensions (WxDxH)	10-5/8 x 13 x 4-5/16 inch
Oven Capacity	0.4 cu.ft (10 liters)
Oven Stackable	Up to 2 units with exclusive joint plates
Catalytic Converter	Yes
Magnetrons	2 (bottom power supply)
Air Filter	Yes removable
Fan Speed	30-100% (adjust by 10%)
Display	Color LCD touch panel
Number of recipes	Up to 1000
Cooking Stages	3
Power Efficiency Control	Yes
Net Weight	83.8 lbs.
Shipping weight	100lbs
Warranty	1 year parts and labor

Output Power

Microwave	1200W (1200 to 0W, 9-Step Switchable)
Broiler	1800 W (Hi) and 1150W (Lo)
Convection	1150W

Preheating

Temperature Range	350–525°F
-------------------	-----------

Convection

Temperature Range	350–525°F
Convection Fan Speed	30-100% (adjust by 10%)

Broil

Power Level	High (Hi) 1.8 kW Low (Lo) 1.15 kW
-------------	-----------------------------------

Max. Combination Power

Convection+Microwave	Convection+Microwave 1200W
Broil+Microwave	Broil/Hi + Microwave 900W
	Broil/Lo + Microwave 1200W
Convection+Broil	Convection + Broil/Hi

Accessories

1 each: Base plate liner, ceramic tray, wire rack, pizza plate, ceramic plate, oven sheet, aluminum paddle, SD memory card, SD-USB adapter

Installation Clearance

From back wall: 1.2"
Between units side by side: 4"
From Top: 8" (do not place in cabinet)



This product conforms to the ventilation recommendations set forth by NFPA96 using EPA202 test method.