



Equipment for the Foodservice Industry

value + quality + service

Salad/Sandwich Prep Tables

CSDR3-72VC



CSDR3-72VC

Features

Features

- Front breathing, side mount compressor
- Exterior & interior stainless steel construction
- Environmentally friendly R290 refrigerant
- Heavy duty Embraco compressor
- Self-closing and stay open door
- Efficient refrigeration system
- Recessed door handle
- Standard safety door lock
- Magnetic door gaskets
- Casters for easy movement
- Pre-installed shelves

Warranty

- One year parts and labour; Five years on compressor
- Specifications subject to change without notice



WARRANTY
INFORMATION
One year parts and
labour. Five years on
compressor



CSDR3-72VC

Specifications

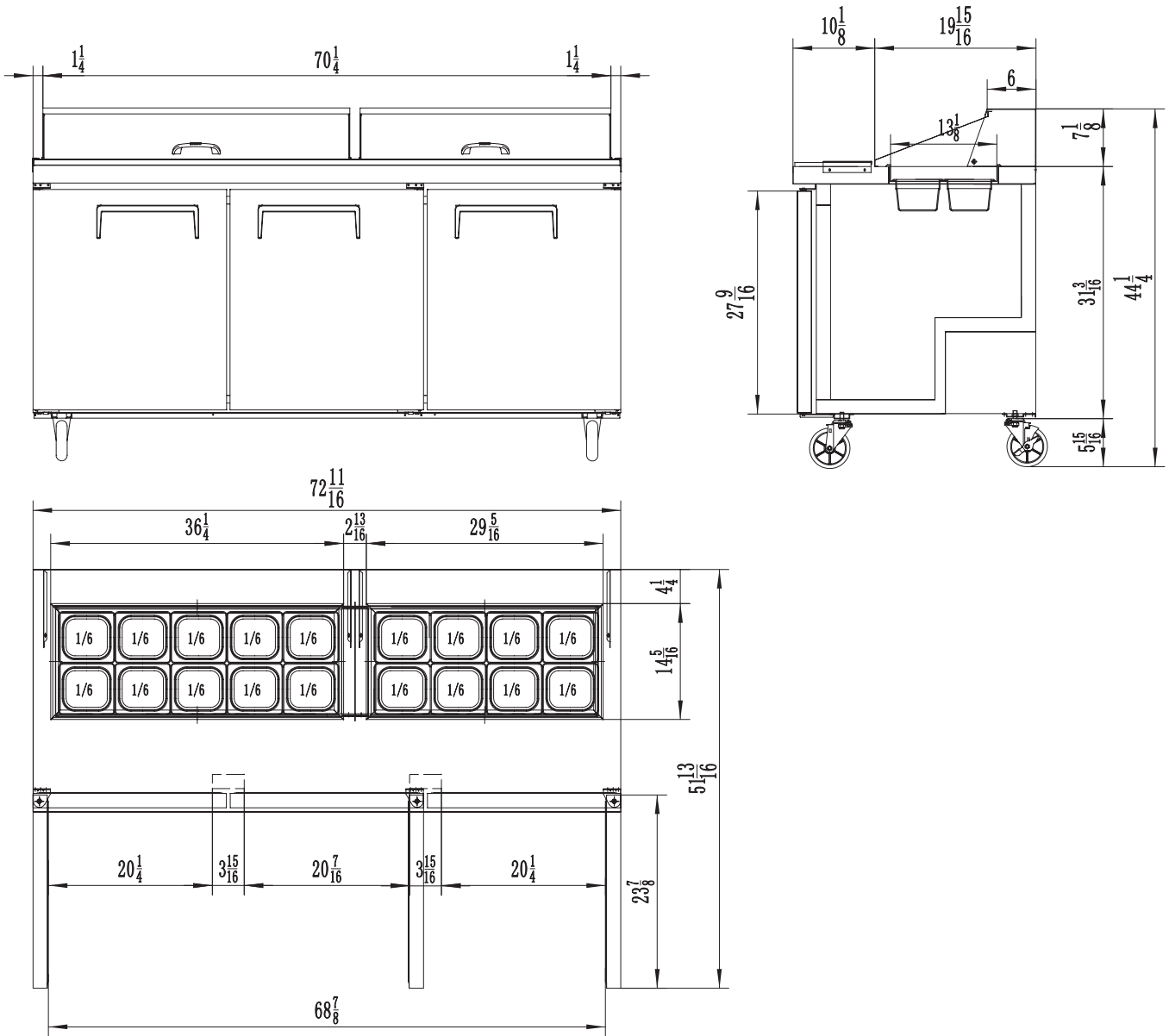

Model	Refrigerant	Doors	Shelves	Dimension (mm) (inch)			HP	Voltage	Amps	Capacity (L) (Cu Ft.)	Net Weight (KG) (LBS)	Temperature Range	NEMA Config.
				L	D	H							
CSDR3-72VC	R290	3	3	1846	762	1109	1/5	115/60	2.8	598	144	1 ~ 8°C	5-15P ⓘ
				72.7	30.0	43.7				21.1	317	33 ~ 45°F	