



SERVING THE FOOD INDUSTRY SINCE 1951

COUNTERTOP CONVECTION OVENS

Item: 43217
Model: CE-CN-0021

Item: 43218
Model: CE-CN-0047

Item: 45599
Model: CE-CN-0066

Item: 44307
Model: CE-CN-0004-C

These models are designed perfectly for coffee shops, small bakeries and restaurants. Feature adjustable timers and temperature controls that to ensure your baked goods cook evenly to perfection.



Item 45599



Item 43218



Item 44307



Item 43217



WARRANTY
PARTS AND LABOR



Authorized Dealer

COOKING EQUIPMENT

COUNTERTOP CONVECTION OVEN - QUARTER SIZE



Features:

- 21L convection oven for small restaurants, bars, coffee shops, ideal for fast cheese melting & toasting
- Functions of baking, defrosting, warming, reheating
- To bake cookies, muffins, steak, biscuits, cake, bread, hamburgers, sandwiches, pizza rapidly
- Air forced heat circulation for even cooking
- Heavy duty stainless steel housing and exterior
- Double pane glass door to view inside
- Temperature adjustable from 65-250°C/ 150-500°F
- Elegant cool touch aluminum handle
- 120 minutes timer with bell
- Shelf size: 13.7" x 11" / 348 x 280mm
- Power on and ready indication light
- Accessories: 3 chrome wire racks included

TECHNICAL SPECIFICATION

ITEM NUMBER	43217
MODEL	CE-CN-0021
POWER	1440 watts
NUMBER OF RACKS	3
PANS SIZE*	1/4 (13" x 9" x 1" / 330 x 230 x 25mm)
TEMPERATURE RANGE	65 - 250°C / 150 - 500°F
CAPACITY	21L / 0.74 cu.ft
ELECTRICAL	120V/60Hz/1
ADJUSTABLE TIMER	0 - 120 mins
NET WEIGHT	32.4 lbs. / 14.7 kgs.
GROSS WEIGHT	37 lbs. / 16.8 kgs
NET DIMENSIONS	18.7" x 20" x 15" / 475 x 503 x 380 mm
GROSS DIMENSIONS	22" x 22" x 18" / 565 x 565 x 455 mm

*Pans not included

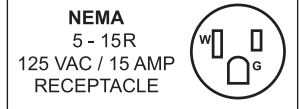

(Front view)

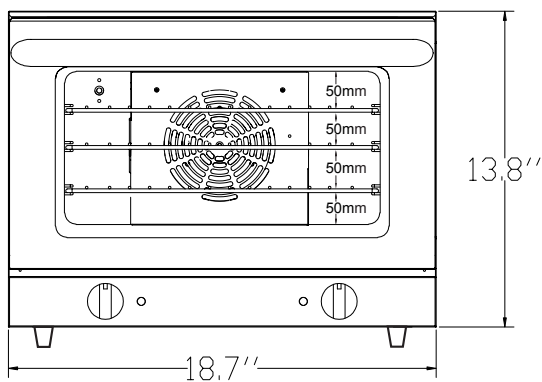

(Top view)

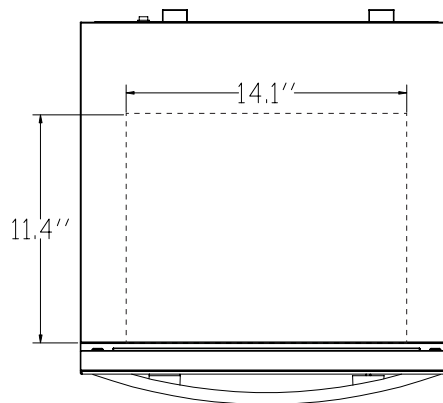

(Side view)

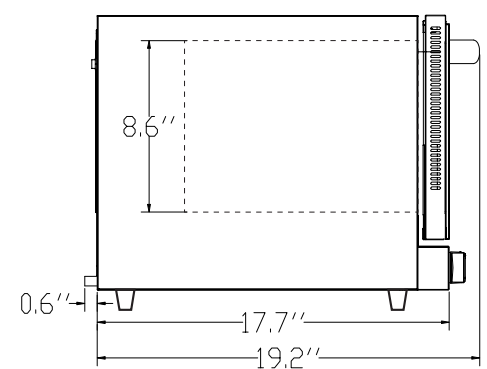

OMCAN INC.

Telephone: 1-800-465-0234
 Fax: (905) 607-0234
 Email: sales@omcan.com
 Website: www.omcan.com



Follow us to keep up to date with the latest news and offers



COOKING EQUIPMENT

COUNTERTOP CONVECTION OVEN - HALF SIZE



Features:

- 47L convection oven for small restaurants, bars, coffee shops, ideal for fast cheese melting & toasting
- Functions of baking, defrosting, warming, reheating
- To bake cookies, muffins, steak, biscuits, cake, bread, hamburgers, sandwiches, pizza rapidly
- Air forced heat circulation for even cooking
- Heavy duty stainless steel housing and exterior
- Double pane glass door to view inside
- Temperature adjustable from 65-250°C/ 150-500°F
- Elegant cool touch aluminum handle
- 120 minutes timer with bell
- Shelf size: 18" x 13"/ 460 x 330mm
- Power on and ready indication light
- Accessories: 4 chrome wire racks

TECHNICAL SPECIFICATION

ITEM NUMBER	43218
MODEL	CE-CN-0047
POWER	1600 watts
NUMBER OF RACKS	4
PANS SIZE*	1/2 (18" x 13" x 1" / 460 x 330 x 25mm)
TEMPERATURE RANGE	65 - 250°C / 150 - 500°F
CAPACITY	47L / 1.66 cu.ft
ELECTRICAL	120V/60Hz/1
ADJUSTABLE TIMER	0 - 120 mins
NET WEIGHT	43.4 lbs. / 19.7 kgs.
GROSS WEIGHT	49 lbs. / 22.3 kgs
NET DIMENSIONS	22.8" x 22.4" x 16" / 580 x 570 x 406 mm
GROSS DIMENSIONS	26" x 26" x 18" / 650 x 650 x 465 mm

*Pans not included



NEMA
5-20R
125 VAC / 20 AMP
RECEPTACLE



(Front view)

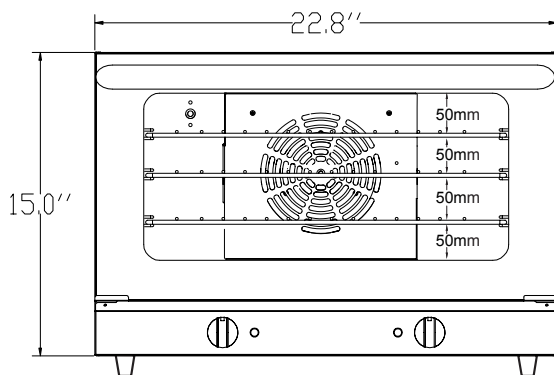

(Top view)

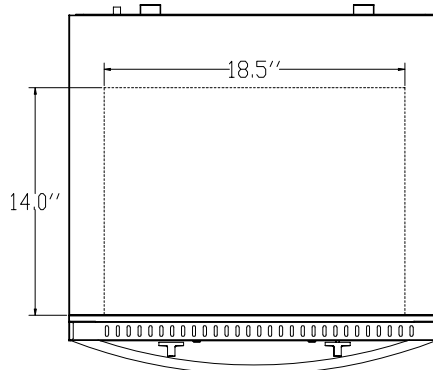

(Side view)

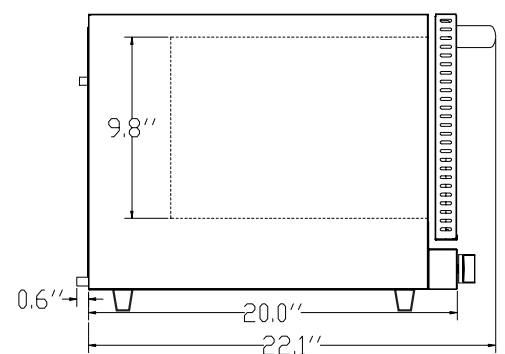

OMCAN INC.

Telephone: 1-800-465-0234
 Fax: (905) 607-0234
 Email: sales@omcan.com
 Website: www.omcan.com



Follow us to keep up to date with the latest news and offers



COOKING EQUIPMENT

COUNTERTOP CONVECTION OVEN - HALF SIZE



Features:

- 66L convection oven for small restaurants, bars, coffee shops, ideal for fast cheese melting & toasting
- Functions of baking, defrosting, warming, reheating
- To bake cookies, muffins, steak, biscuits, cake, bread, hamburgers, sandwiches, pizza rapidly
- Air forced heat circulation for even cooking
- Heavy duty stainless steel housing and exterior
- Double pane glass door to view inside
- Temperature adjustable from 65-250°C/ 150-500°F
- Elegant cool touch aluminum handle
- 120 minutes timer with bell
- Shelf size: 18" x 13"/ 460 x 330mm
- Power on and ready indication light
- Accessories: 4 chrome wire racks included

TECHNICAL SPECIFICATION

ITEM NUMBER	45599
MODEL	CE-CN-0066
POWER	2800 watts
NUMBER OF RACKS	4
PANS SIZE*	1/2 (18" x 13"/ 460 x 330mm)
TEMPERATURE RANGE	65 - 250°C/ 150 - 500°F
CAPACITY	66L/ 2.3 cu.ft
ELECTRICAL	220V/60Hz/1
ADJUSTABLE TIMER	0 - 120 mins
NET WEIGHT	23.6 Kg
GROSS WEIGHT	27 Kg
NET DIMENSIONS	22.8" x 22" x 20" 580 x 570 x 510 mm
GROSS DIMENSIONS	23.6" x 25.6" x 22.8"/ 600 x 650 x 580 mm

*Pans not included

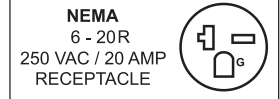

(Front view)

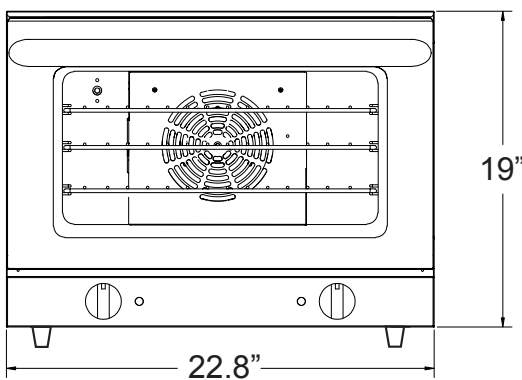

(Top view)

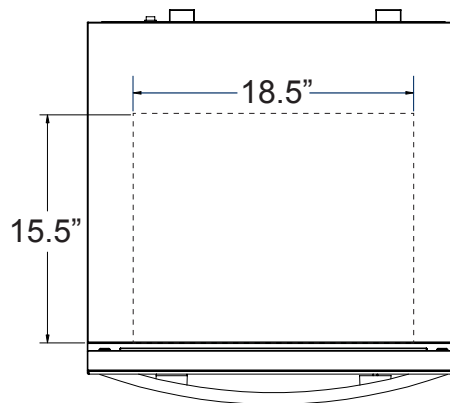

(Side view)

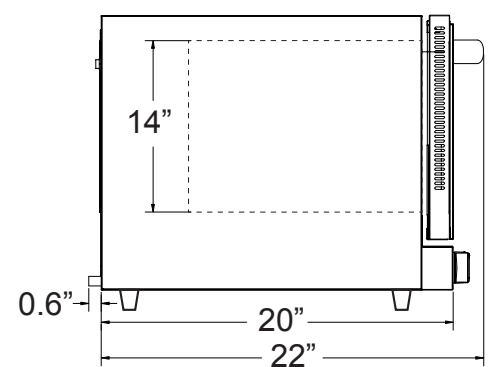

OMCAN INC.

Telephone: 1-800-465-0234
 Fax: (905) 607-0234
 Email: sales@omcan.com
 Website: www.omcan.com



Follow us to keep up to date with the latest news and offers



COOKING EQUIPMENT

COUNTERTOP CONVECTION OVEN - FULL SIZE



Features:

- 100L convection oven for different kinds of bakeries
- Functions of baking, defrosting, warming, reheating
- For bread, cake, toast, sandwiches, pizza, muffins, potato
- Dual fan air convection for even cooking
- Heavy duty stainless steel housing and exterior
- Double pane glass door to view inside
- Temperature adjustable from 65 - 300°C/ 150 - 500°F
- Push bottom humidity control
- With over heating protection
- 120 minutes timer
- Shelf size: 26" x 17.9" / 660 x 455 mm
- Power on and ready indication light
- Accessories: 4 chrome wire racks

TECHNICAL SPECIFICATION

ITEM NUMBER	44307
MODEL	CE-CN-0004-C
POWER	4500 Watts
NUMBER OF RACKS	4
PANS SIZE*	Full size (26" x 18.1" x 1" / 660 x 460 x 25 mm)
TEMPERATURE RANGE	65 - 300°C/ 150 - 500°F
CAPACITY	100 L
ELECTRICAL	220V / 60Hz / 1Ph
ADJUSTABLE TIMER	0 - 120 mins
NET WEIGHT	100.5 lbs. / 45.6 kg.
GROSS WEIGHT	126 lbs. / 57.2 kg.
NET DIMENSIONS	31.8" x 28.8" x 22.75" / 807 x 732 x 578 mm
GROSS DIMENSIONS	37" x 32.48" x 26.18" / 940 x 825 x 665 mm

*Pans not included

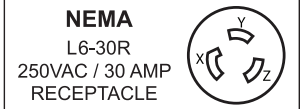

(Front view)

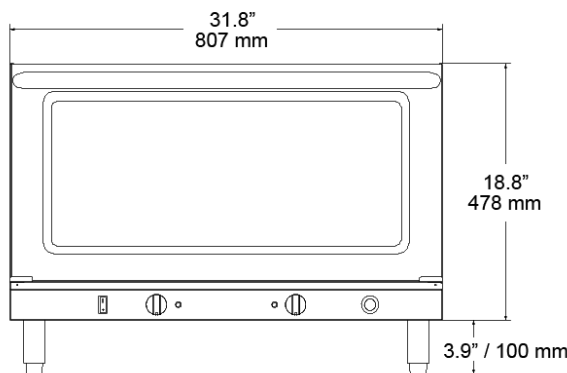

(Side view)

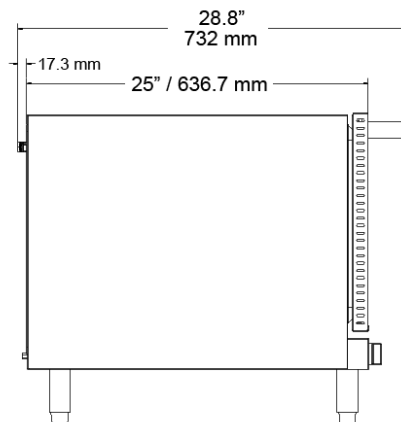

OMCAN INC.

Telephone: 1-800-465-0234
 Fax: (905) 607-0234
 Email: sales@omcan.com
 Website: www.omcan.com



Follow us to keep up to date with the latest news and offers

