



REFRIGERATION

SERVING IN THE FOOD INDUSTRY SINCE 1951

40-INCH OPEN REFRIGERATED DISPLAY CASE WITH 13.42 CU.FT.

Item #: 40004

Model: RS-CN-0380



*High Performance
and Quality
Open Refrigerated
Floor Display Case*

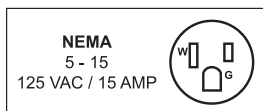

Authorized Dealer

REFRIGERATION

OPEN REFRIGERATED FLOOR DISPLAY CASE



Great for displaying dairy products, vegetables, fruits and drinks.

Features:

- ① Pull down curtain.
- ② LED lighting.
- ③ Adjustable shelf position.
- ④ Digital temperature controls.
- ⑤ Casters.

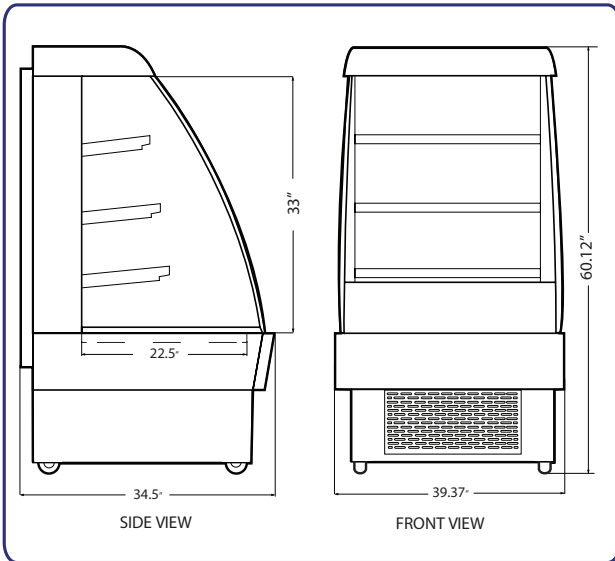

PRODUCT SPECIFICATIONS

ITEM NUMBER	40004	TYPE OF CLIMATE	6
MODEL	RS-CN-0380	RATED CURRENT (A)	9.7
RATED INPUT POWER	970 W	SHELF SIZE (DxW)	10" / 12" / 14" x 35.25"
ELECTRICAL HEATING ELEMENT	450 W	INNER DIMENSIONS (WDH)	37" x 22.5" x 33"
CAPACITY (L / CU. FT.)	380 L / 13.42 cu.ft.	FOAMING AGENT	XPS
ELECTRICAL	110 V / 60 Hz / 1	WEIGHT	112 kg. / 246.4 lbs
LAMP POWER (W)	2.8 Watts x 2 (LED)	PACKAGING WEIGHT	122 kg. / 268.4 lbs.
TEMPERATURE	2 - 10°C / 35.6 - 50°F	DIMENSIONS (WDH)	39.37" x 34.50" x 60.12"
AMBIENT TEMPERATURE /RH	<27°C (80.6°F) / 70%	PACKAGING DIMENSIONS	42" x 38" x 63"
REFRIGERANT & INJECTION	R134a and 540		

OMCAN INC.

Telephone: 1-800-465-0234
 Fax: (905) 607-0234
 E-mail: sales@omcan.com
 Website: www.omcan.com



Follow us to keep up to date with the latest news and offers

