

Making it all about the food - and your profits

Multi Deck Display 36 - 4 shelves

Self-serve, for packaged hot food



With full focus on the food, the best hot holding conditions in the industry and up to 50% less energy consumption than competitor units, Fri-Jado's Multi Deck Display (MDD) is the ideal solution to boost your profit from packaged grab-and-go products.

The combination of its transparent design and ultra-thin shelves with LED lighting really puts your food in the spotlights, stimulating impulse buying. Combined with conduction heat, patented hot airflow recirculation per shelf keeps your products warm and safe for longer (less waste!), while minimizing energy consumption. This results in substantial cost savings and a lower impact on the environment.

The Multi Temp function allows you to set temperatures individually for each shelf, in order to fine-tune the holding conditions for hot products from different food groups.

More MDD benefits on frijado.com



Ultimate product visibility - transparent design, thin shelves, no distraction.



Keeps food hot from all sides - Fri-Jado's patented Hot Blanket technology.

Features MDD 36 - 4 Self-serve heated merchandiser

Top features

- Maximum transparency & ultra-thin shelves - full focus on the food, presentation without distraction
- LED lighting above each shelf - puts your food in the spotlights
- Patented Hot Blanket technology, cocooning your products - keeps your food safe & delicious for up to 4 hours
- Minimal energy consumption: up to 50% less than competitor models. Low TCO and better for the environment.
- More space between shelves: safe & easy access into the unit
- Simple operation by means of a single on/off switch (within reach) for both heating and shelf lighting
- Multi Temp function offering easy to change settings **per shelf** - temperature between 104° and 158° F, heating off, lights off
- Easy store integration thanks to transparent and square design
- Endless possibilities, for hot food from all food groups

Standard characteristics

- Self-serve heated display for packaged hot food
- 36 in. wide - 4 shelves
- Total shelf display area of 17.01 ft²
- Footprint of 7.32 ft²
- Solid back or pass-through (backloading model)
- Adjustable shelf angle to further improve product visibility
- Double pane glass on both sides, back insulation
- Front bumper to protect against damage from shopping carts
- Castors - for easy moving
- Including price rail set

Options & Accessories

- Front door set
- Merchandising racks
- Levelling legs
- Condiment holder
- Shelf insert trays
- Temperature indicator
- Shelf dividers



Food (literally) in the spotlights - LED lighting above each shelf.

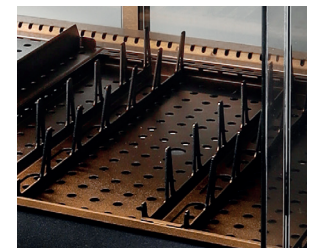

Wide range of accessories available.

MDD 36 - 4

1 Power cable, 8 ft 2.4 in.

Dimensions

Width	35 7/16"
Depth	29 1/2"
Height	67 13/16"

Technical data

Net weight	485 lbs
Voltage	3~ 208 V
Frequency	50/60 Hz
Power	4.1 kW

Models

Solid back Multi Temp	MDD 36-4 SB MT
Pass through Multi Temp	MDD 36-4 PT MT

Patent number: EP2309897

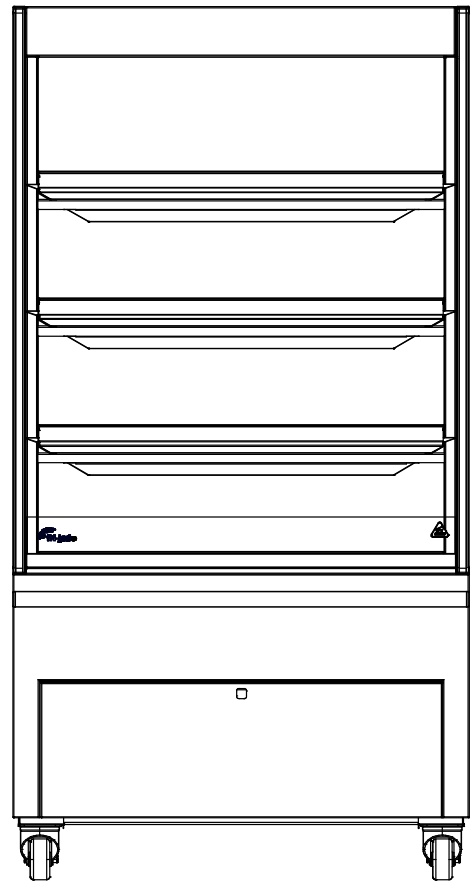
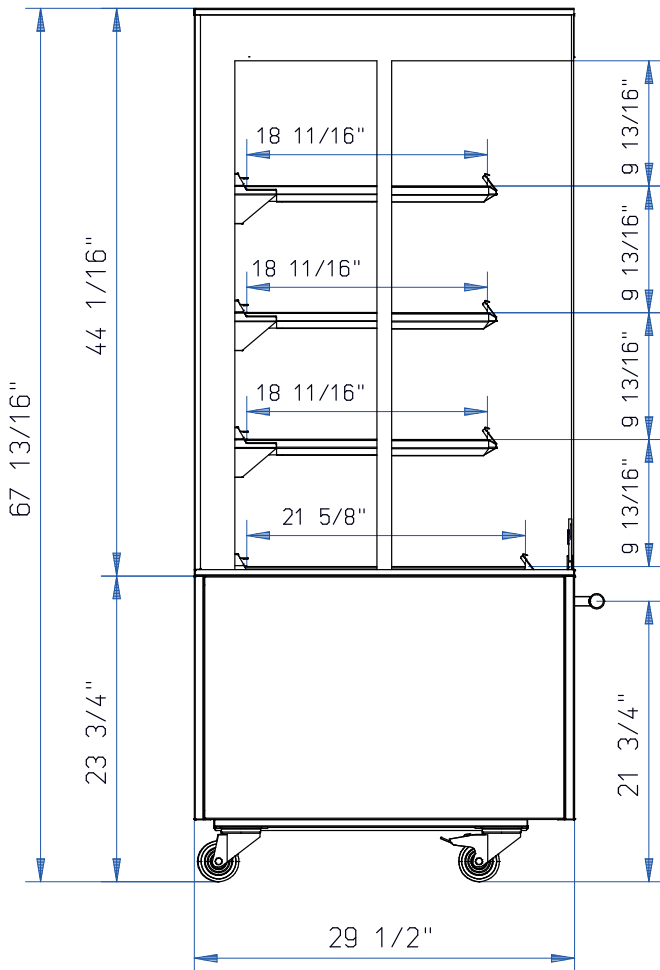
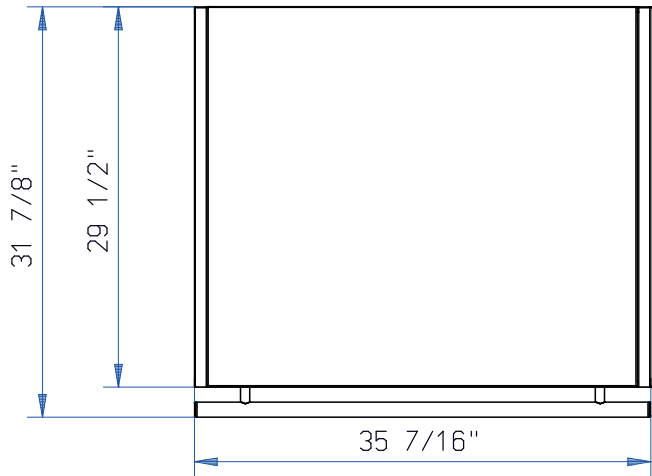

Specifications and technical data are subject to amendment without notice.

These are basic drawings. For more detailed technical information, please refer to the installation manual at www.frijado.com.



The MDD Hot is ETL listed (meets UL standard 197, NSF standard 4 and CSA standard C22.2 No. 109).



Fri-Jado Inc.
1401 Davey Road
Suite 100
Woodridge IL 60517
Toll free 877-374-5236
e-mail us.info@frijado.com
www.frijado.com

MDD36-4-USA-01042022