

BOCCHI®

Installation Manual



**2002 0001, 2003 0001, 2004 0001, 2005 0001, 2006 0001,
2007 0001, 2008 0001, 2009 0001, 2010 0001, 2011 0001**

PULL-OUT SPRAY KITCHEN FAUCET

1. Installation Attention

1. Open the product packing; check for all the accessories according to the accessories list. If you lack any accessories, please contact your local supplier.
2. The cartridge is the main body it has been tested and adjusted in the factory, do not remove it or take it apart.
3. Before installing your new mixer, flush through the supply pipes to ensure the removal of debris to avoid and prevent clogs.
4. After installing, check the supply pipes to avoid any leakage.
5. Inlet water pressure: $0.05\text{Mpa} < \text{inlet water pressure} < 0.75\text{Mpa}$ (including cold water pressure).

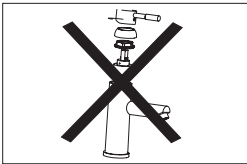

Do not take the faucet apart

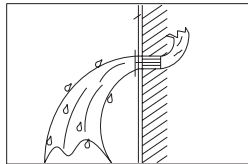

Keep the supply pipes unblocked

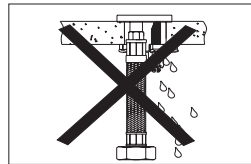

No leakage in the connection

Note: We have been enhancing our products quality by constantly improving the design and performance. We reserve the right to change specifications, product descriptions, product quality, pricing and application at any time without prior written or oral notice.

2. Accessories list

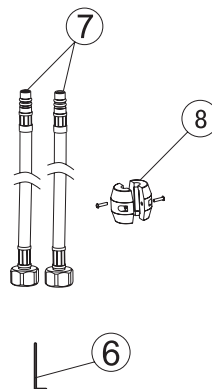
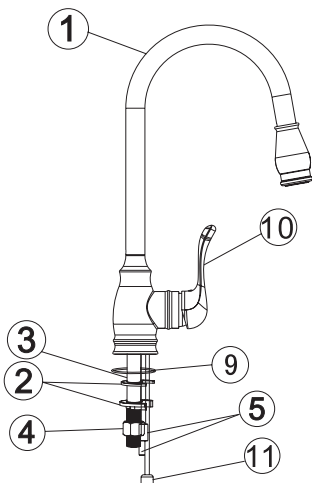

11	Outlet pipe
10	Handle
9	O-ring
8	Weight balance
7	Hose
6	Allen key
5	Inlet Pipe
4	Locking nut
3	Thread tube
2	Gasket
1	Body
ITEM	DESCRIPTION

3. Dimension drawing

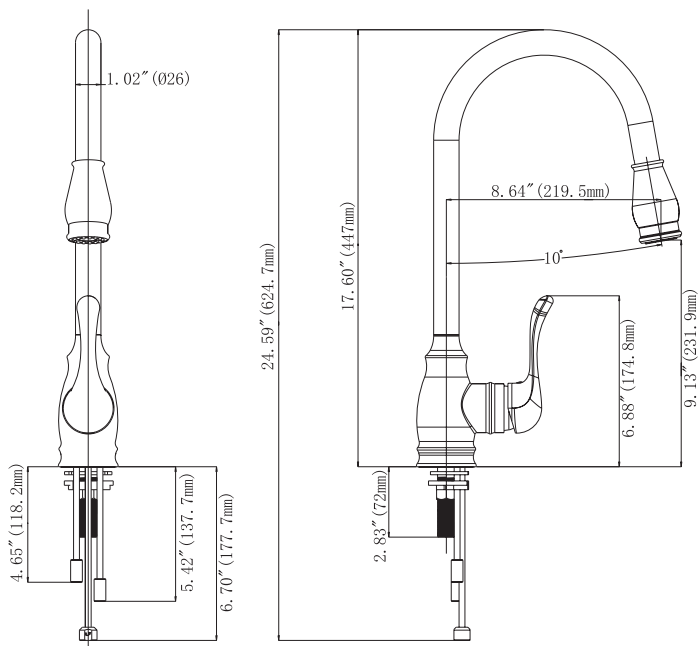

4. Instruction

1. Move the handle left to control the hot water, move the handle right to control the cold water.
2. Move the handle right to turn on the mixer, move it vertically to close.

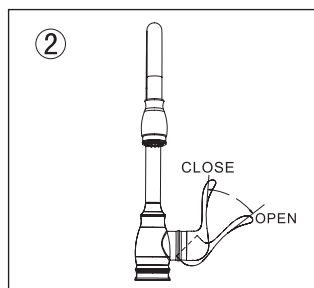
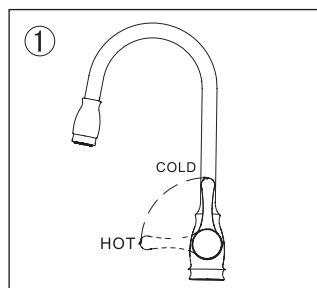

Installation steps

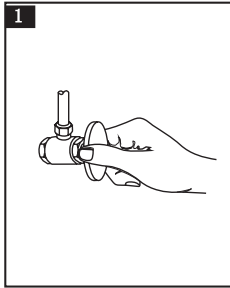

You should clean all the dirt from valve outlets. Turn off the water supply valves. This is usually found near the water meter. If you are replacing an existing faucet, remove the faucet from the sink and clean the sink surface thoroughly

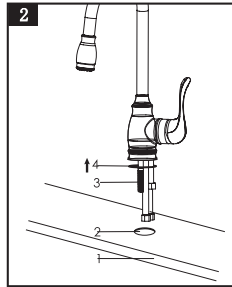

Drill a $\varnothing 1-3/8''$ to $\varnothing 1-1/2$ hole (2) in sink (1). Install the thread tube (3) and screw them firmly. Put O-ring (4) into base groove and then insert them through the hole (2).

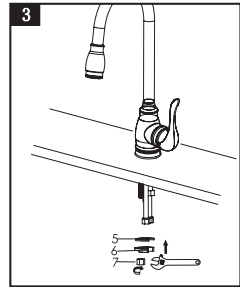

Put all hose through the C Rubber washer (5) then through the C metal Washer (6), finally screw the nut fitting (7).

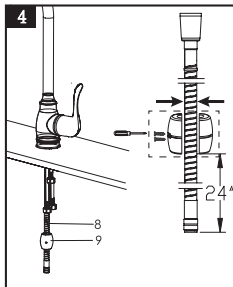

Fix the weight balance (9) on the suitable position of the sprayer flexible hose (8) to keep the pulling smoothly.

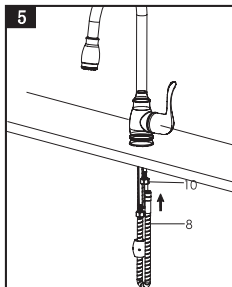

Connect the hose (8) with outlet pipe (10).

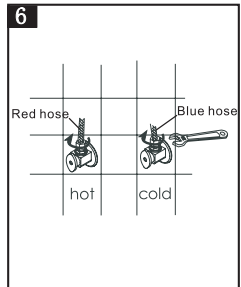

Check the flexible hoses to make it clean and connect them to the water-supplying valve (left to hot water and right to cold)

Warranty: This warranty cover faucets only for a one year period. Proof of purchase must accompany all warranty claims. Warranty will provide the parts necessary to put the faucet back in good working condition only, **excluding labor charges.**

BOCCHI USA

11350 Old Roswell Rd. STE 600 T. 877-565-2221
Alpharetta, GA 30009