

# **Digital Video Recorder**

## **Quick Operation Guide**

# TABLE OF CONTENTS

<b>DVR Pre-Installation .....</b>	<b>5</b>
<b>DVR Installation .....</b>	<b>5</b>
<b>Hard Disk Installation .....</b>	<b>5</b>
<b>Front Panels.....</b>	<b>7</b>
<b>Rear Panels.....</b>	<b>9</b>
<b>Peripheral Connections .....</b>	<b>11</b>
<b>Wiring of Alarm Input.....</b>	<b>11</b>
<b>Wiring of Alarm Output.....</b>	<b>11</b>
Alarm Connection .....	11
RS-485 and Controller Connection .....	12
Termination Switch Operation .....	13
<b>Specifications.....</b>	<b>14</b>
Table 1 Specification.....	14
Table 2 Specification.....	15
<b>HDD Storage Calculation Chart.....</b>	<b>16</b>
<b>Accessing by Web Browser.....</b>	<b>17</b>
Logging In.....	17
Live View.....	17
Recording.....	18
Playback.....	19
Log.....	20
<b>Menu Operation.....</b>	<b>21</b>
Menu Structure.....	21
Startup and Shutdown .....	21
Live View.....	22
Adding IP Cameras .....	22
Record.....	24
Instant Recording .....	24
All-day Recording.....	24
Playback.....	25
Backup.....	26

## Regulatory information

### FCC information

**FCC compliance:** This equipment has been tested and found to comply with the limits for a digital device, pursuant to part 15 of the FCC Rules. These limits are designed to provide reasonable protection against harmful interference when the equipment is operated in a commercial environment. This equipment generates, uses, and can radiate radio frequency energy and, if not installed and used in accordance with the instruction manual, may cause harmful interference to radio communications. Operation of this equipment in a residential area is likely to cause harmful interference in which case the user will be required to correct the interference at his own expense.

### FCC conditions

This device complies with part 15 of the FCC Rules. Operation is subject to the following two conditions:

1. This device may not cause harmful interference.
2. This device must accept any interference received, including interference that may cause undesired operation.

### EU Conformity Statement



This product and - if applicable - the supplied accessories too are marked with "CE" and comply therefore with the applicable harmonized European standards listed under the Low Voltage Directive 2006/95/EC, the EMC Directive 2004/108/EC, the RoHS Directive 2011/65/EU.



2012/19/EU (WEEE directive): Products marked with this symbol cannot be disposed of as unsorted municipal waste in the European Union. For proper recycling, return this product to your local supplier upon the purchase of equivalent new equipment, or dispose of it at designated collection points. For more information see:

[www.recyclethis.info](http://www.recyclethis.info).



2006/66/EC (battery directive): This product contains a battery that cannot be disposed of as unsorted municipal waste in the European Union. See the product documentation for specific battery information. The battery is marked with this symbol, which may include lettering to indicate cadmium (Cd), lead (Pb), or mercury (Hg). For proper recycling, return the battery to your supplier or to a designated collection point. For more information see:

[www.recyclethis.info](http://www.recyclethis.info).

## Trademarks and Registered Trademarks

- Windows and Windows mark are trademarks or registered trademarks of Microsoft Corporation in the United States and/or other countries.
- HDMI, HDMI mark and High-Definition Multimedia Interface are trademarks or registered trademarks of HDMI Licensing LLC.
- The products contained in this manual are authorized by HDMI Licensing LLC with the use right of the HDMI technology.



- VGA is the trademark of IBM.
- UPnP™ is a certification mark of the UPnP™ Implementers Corporation.
- Other names of companies and product contained in this manual may be trademarks or registered trademarks of their respective owners.

Thank you for purchasing our product. If there is any question or request, please do not hesitate to contact dealer.  
This manual is applicable to 4/8/16ch HD-TVI DVR.

## DVR Pre-Installation

The HD-TVI series DVR is highly advanced surveillance equipment that should be installed carefully. Please take into consideration the following precautionary steps before installation of the DVR.

1. Keep all liquids away from the DVR.
2. Install the DVR in a well-ventilated and dust-free area.
3. Ensure environmental conditions meet factory specifications.
4. Install a manufacturer recommended HDD.

## DVR Installation

During the installation of the DVR:

1. Use brackets for rack mounting.
2. Ensure there is ample room for audio and video cables.
3. When installing cables, ensure that the bend radius of the cables are no less than five times than its diameter.
4. Connect both the alarm and RS-485 cable.
5. Allow at least 2cm ( $\approx 0.75$ -inch) of space between racks mounted devices.
6. Ensure the DVR is grounded.
7. Environmental temperature should be within the range of  $-10\text{ }^{\circ}\text{C} \sim 55\text{ }^{\circ}\text{C}$ ,  $14\text{ }^{\circ}\text{F} \sim 131\text{ }^{\circ}\text{F}$ .
8. Environmental humidity should be within the range of  $10\% \sim 90\%$ .

## Hard Disk Installation

### *Before you start:*

Before installing a hard disk drive (HDD), please make sure the power is disconnected from the DVR. A factory recommended HDD should be used for this installation.

Up to 4 SATA hard disks can be installed on your DVR.

**Tools Required:** Screwdriver.



As the installation steps of HDD are similar among different models, here we take one model as an example.

### *Steps:*

1. Remove the cover from the DVR by unfastening the screws on the back and side.



2. Connect one end of the data cable to the motherboard of DVR and the other end to the HDD.

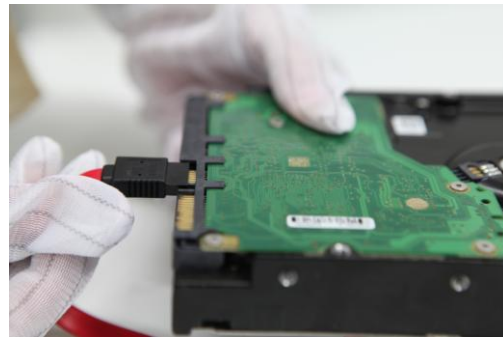
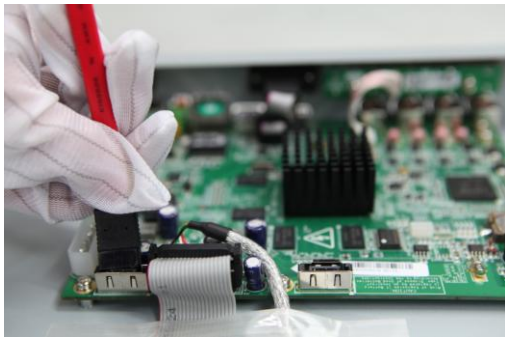

3. Connect the power cable to the HDD.

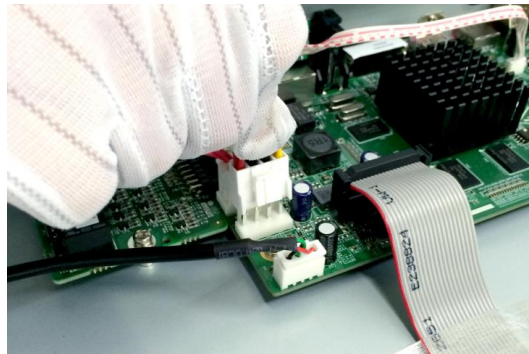

4. Place the HDD on the bottom of the device and then fasten the screws on the bottom to fix the HDD.

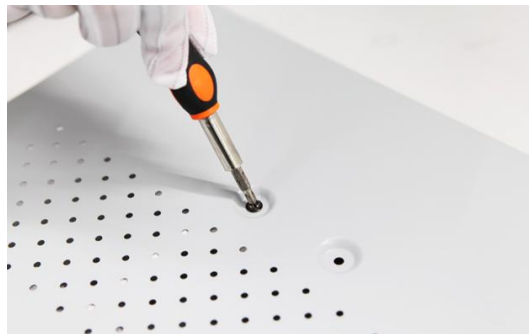

5. Re-install the cover of the DVR and fasten screws.

## Front Panels



Front Panel of 4ch/8ch



Front Panel of 16ch series

### Description of Front Panel

No.	Name	Function Description	
1	Status Indicators	POWER: the POWER indicator turns green when NVR is powered up.	
		READY: The indicator light is green when the device is running normally.	
		STATUS: 1.The light is green when the IR remote control is enabled; 2.The light is red when the function of the composite keys (SHIFT) are used; 3. The light is out when none of the above condition is met/	
		ALARM: the light is red when there is an alarm occurring.	
		HDD: the indicator flickers red when HDD is reading/writing.	
		Tx/Rx: TX/RX indicator flickers green when network connection is functioning normally.	
2	USB Interfaces	Universal Serial Bus (USB) ports for additional devices such as USB mouse and USB Hard Disk Drive (HDD).	
3	Composite Keys	1/MENU:	Enter numeral "1";
			Access the main menu interface.
		2/ABC/F1:	Enter numeral "2";
			Enter letters "ABC";
			The F1 button when used in a list field will select all items in the list.
		3/DEF/F2:	In PTZ Control mode, it will turn on/off PTZ light and when the image is zoomed in, the key is used to zoom out.
			Enter numeral "3";
			Enter letters "DEF";
			The F2 button is used to change the tab pages.
		4/GHI/ESC:	In PTZ control mode, it zooms in the image.
			Enter numeral "4";
			Enter letters "GHI";
		Exit and back to the previous menu.	



No.	Name	Function Description	
		<b>5/JKL/EDIT:</b>	Enter numeral "5";
			Enter letters "JKL";
			Delete characters before cursor;
			Check the checkbox and select the ON/OFF switch;
			Start/stop record clipping in playback.
		<b>6/MNO/PLAY:</b>	Enter numeral "6";
			Enter letters "MNO";
			Playback, for direct access to playback interface.
		<b>7/PQRS/REC:</b>	Enter numeral "7";
			Enter letters "PQRS";
			Open the manual record interface.
		<b>8/TUV/PTZ:</b>	Enter numeral "8";
			Enter letters "TUV";
			Access PTZ control interface.
		<b>9/WXYZ/PREV:</b>	Enter numeral "9";
			Enter letters "WXYZ";
			Multi-channel display in live view.
		<b>0/A:</b>	Enter numeral "0";
Shift the input methods in the editing text field. (Upper and lowercase, alphabet, symbols or numeric input).			
Double press the button to switch the main and auxiliary output.			
<b>4</b>	<b>SHIFT</b>	Switch between the numeric or letter input and functions of the composite keys. (Input letter or numbers when the light is out; Realize functions when the light is red.)	
<b>5</b>	<b>Control Buttons</b>	<p>Directional buttons:</p> <p>In menu mode, the direction buttons are used to navigate between different fields and items and select setting parameters. In playback mode, the Up and Down buttons are used to speed up and slow down record playing, and the Left and Right buttons are used to move the recording 30s forwards or backwards.</p> <p>In the image setting interface, the up and down button can adjust the level bar of the image parameters.</p> <p>In live view mode, these buttons can be used to switch channels.</p> <p>Enter:</p> <p>The Enter button is used to confirm selection in menu mode; or used to check checkbox fields and ON/OFF switch.</p> <p>In playback mode, it can be used to play or pause the video.</p> <p>In single-frame play mode, pressing the Enter button will play the video by a single frame.</p> <p>And in auto sequence view mode, the buttons can be used to pause or resume auto sequence.</p>	
<b>6</b>	<b>IR Receiver</b>	Receiver for IR remote.	

## Rear Panels



The rear panel varies according to different models.

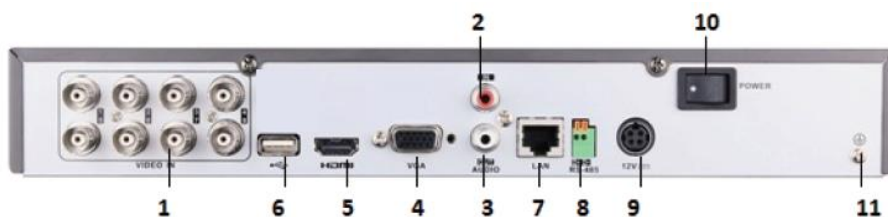

4/8Ch Series without alarm

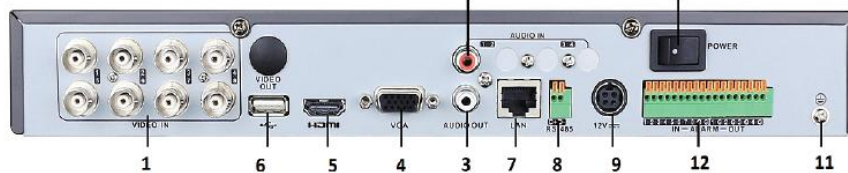

4/8Ch Series with alarm

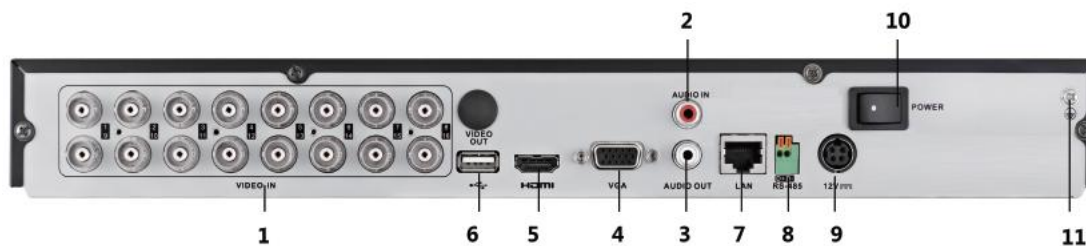

16CH Series without alarm



16CH Series with alarm

No.	Item	Description
1	<b>VIDEO IN</b>	BNC interface for TVI and analog video input.
2	<b>AUDIO IN</b>	RCA connector
3	<b>AUDIO OUT</b>	RCA connector
4	<b>VGA</b>	DB15 connector for VGA output. Display local video output and menu.
5	<b>HDMI</b>	HDMI video output connector.
6	<b>USB Port</b>	Universal Serial Bus (USB) port for additional devices.
7	<b>Network Interface</b>	Connector for network
8	<b>RS-485 Interface</b>	Connector for RS-485 devices.
9	<b>Power Supply</b>	DC 12V power supply.
10	<b>Power Switch</b>	Switch for turning on/off the device.
11	<b>GND</b>	Ground
12	<b>Alarm</b>	Alarm in/out

## Peripheral Connections

### Wiring of Alarm Input

The alarm input is an open/closed relay. To connect the alarm input to the device, use the following diagram.



If the alarm input is not an open/close relay, please connect an external relay between the alarm input and the device.

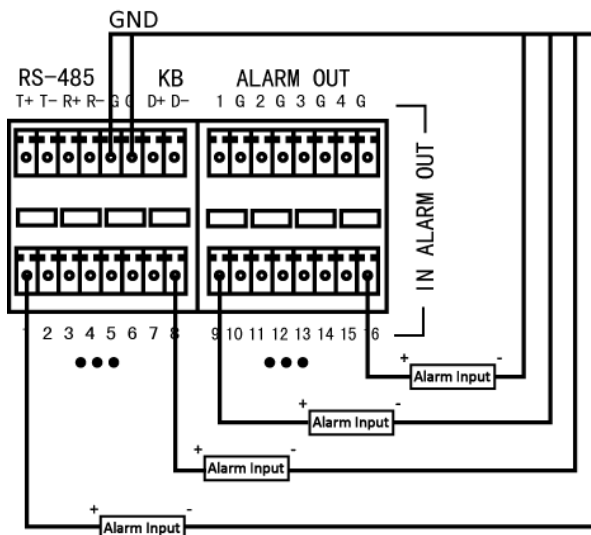

### Wiring of Alarm Output

To connect to an alarm output (AC or DC load), use the following diagram:

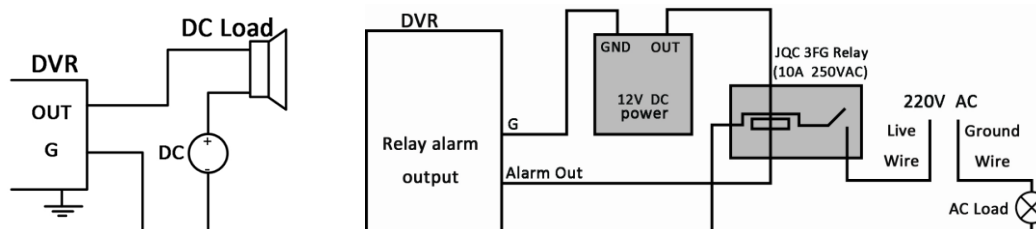

DC Load Connection Diagram

AC Load Connection Diagram

For DC load, the jumpers can be used within the limit of 12V/1A safely.

To connect an AC load, jumpers should be left open (you must remove the jumper on the motherboard in the DVR). Use an external relay for safety (as shown in the figure above).

There are 4 jumpers (JP1, JP2, JP3, and JP4) on the motherboard, each corresponding with one alarm output. By default, jumpers are connected. To connect an AC load, jumpers should be removed.

#### Example:

If you connect an AC load to the alarm output 3 of the DVR, then you must remove the JP 3.

### Alarm Connection

To connect alarm devices to the DVR:

1. Disconnect *pluggable block* from the ALARM IN /ALARM OUT terminal block.
2. Press and hold the orange part of the *pluggable block*; insert signal cables into slots and release the orange part.

Ensure signal cables are in tight.

3. Connect *pluggable block* back into terminal block.

## RS-485 and Controller Connection

### Series 1

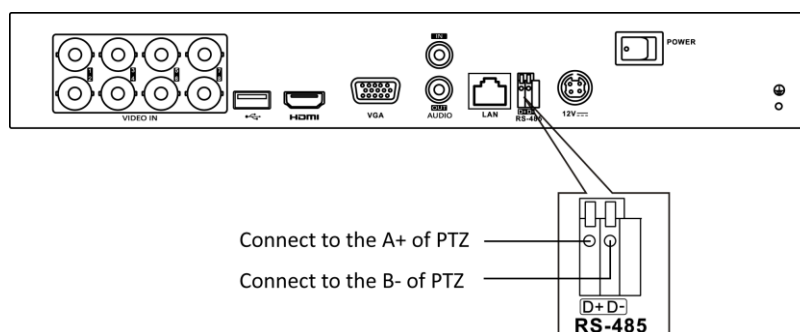

#### To connect PTZ to the DVR:

1. Disconnect *pluggable block* from the RS-485 terminal block.
2. Press and hold the orange part of the *pluggable block*; insert signal cables into slots and release the orange part. Ensure signal cables are in tight.
3. Connect A+ on PTZ to D+ on terminal block and B- on controller to D- on terminal block. Fasten stop screws.
4. Connect *pluggable block* back into terminal block.

### Series 2

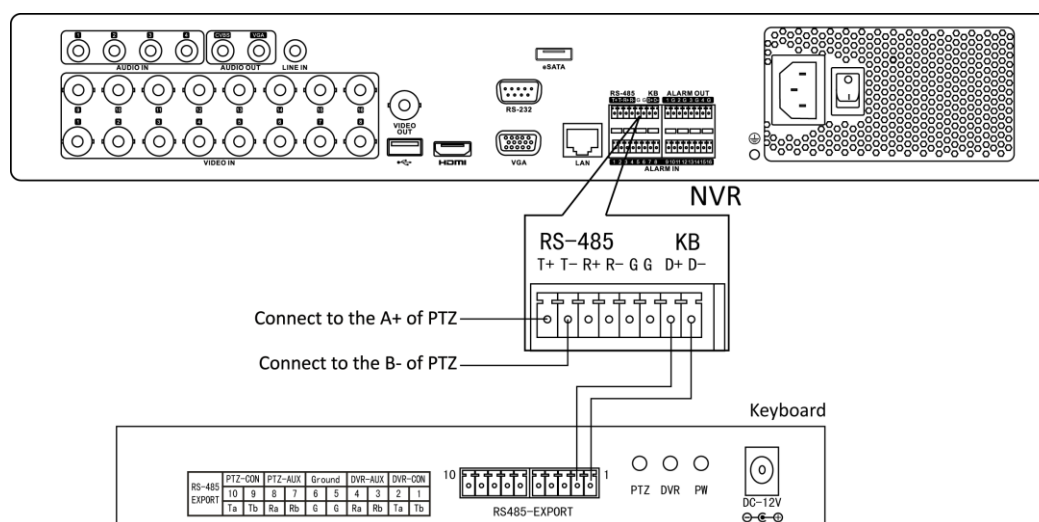

#### To connect PTZ to the DVR:

1. Disconnect *pluggable block* from the RS-485 terminal block.
2. Press and hold the orange part of the *pluggable block*; insert signal cables into slots and release the orange part. Ensure signal cables are in tight.
3. Connect A+ on PTZ to T+ on terminal block and B- on controller to T- on terminal block. Fasten stop screws.
4. Connect *pluggable block* back into terminal block.

#### To connect a controller to the DVR:

1. Disconnect *pluggable block* from the KB terminal block.
2. Press and hold the orange part of the *pluggable block*; insert signal cables into slots and release the orange

part. Ensure signal cables are in tight.

3. Connect Ta on controller to D+ on terminal block and Tb on controller to D- on terminal block. Fasten stop screws.
4. Connect *pluggable block* back into terminal block.



Make sure both the controller and DVR are grounded.

## Termination Switch Operation



- This function is applicable to certain models only.
- The termination switch is placed on the mainboard instead of the rear panel. Open the upper cover and turn on/off the SW switch if needed.

### **Purpose:**

To connect the DVR with several speed domes, the bus topology can be adopted, which means the speed domes are connected with each other via the R+ and R- of RS-485 serial interface. But due to the impedance of 485 wire, the longer the wire is, the greater the impedance gets.

To avoid the signal reduction caused by the great impedance of long distance transmission, please connect two 120Ω resistors in the circuit: one resistor between the DVR and the nearest speed dome, and the other one after the furthest speed dome.

### **Steps:**

1. Turn on the SW switches on the DVR and the furthest speed dome.
2. Keep other SW switches off.

The connection diagram and status of each SW switch are shown in the following figure.

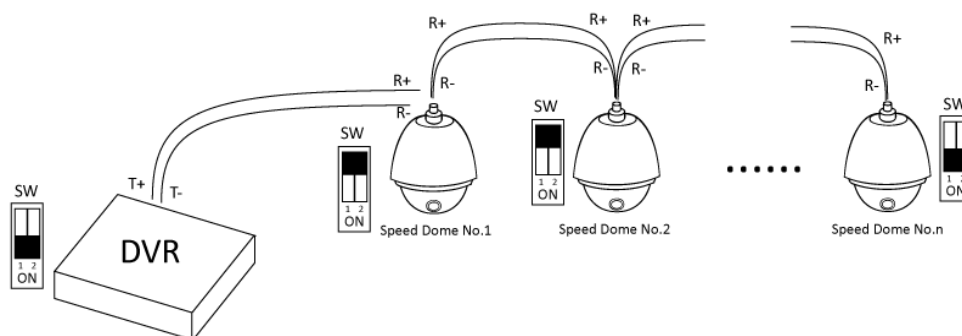

# Specifications

## Table 1 Specification

Model		TVR-448+1IP	TVR-896+2IP	TVR-16192+2IP
Video/Audio input	Video compression	H.264		
	Analog and HD-TVI video input	4-ch	8-ch	16-ch
	Supported camera types	BNC interface (1.0Vp-p, 75 Ω)		
	IP video input	720P/25, 720P/30, 720P/50, 720P/60, 1080P/25, 1080P/30, CVBS		
	IP video input	1-ch	2-ch	2-ch
	Audio compression	Up to 2.0MP resolution		
	Audio input / Two-way audio in	G.711u		
Video/Audio output	HDMI / VGA output	1-ch, RCA (2.0 Vp-p, 1 KΩ)		
	Encoding resolution	1920 × 1080 / 60 Hz, 1280 × 1024 / 60 Hz, 1280 × 720 / 60 Hz, 1024 × 768 / 60 Hz		
		Main stream: 1080P(non-real-time) / 720P / VGA / WD1 / 4CIF / CIF Sub-stream: WD1(non-real-time) / 4CIF(non-real-time) / CIF / QCIF / QVGA		
	Frame rate	Main stream: 1/16 fps ~ Real time frame rate		
		Sub-stream: 1/16 fps ~ Real time frame rate		
	Video bitrate	32 Kbps-6 Mbps		
	Audio output	1-ch, RCA (Linear, 1KΩ)		
	Audio bitrate	64 Kbps		
	Dual-stream	Support		
	Stream type	Video, Video & Audio		
Synchronous playback	4-ch	8-ch	16-ch	
Playback resolution	1080P / 720P / VGA / WD1 / 4CIF / CIF / QVGA / QCIF			
Network management	Remote connections	128		
	Network protocols	TCP/IP, PPPoE, DHCP, DNS, DDNS, NTP, SADP, SMTP, SNMP, NFS, iSCSI, UPnP™, HTTPS		
Hard disk	SATA	1 SATA interface		2 SATA interfaces
	Capacity	Up to 4 TB capacity for each disk		
External interface	Network interface	1; 10M / 100M self-adaptive Ethernet interface		1; 10M / 100M / 1000M self-adaptive Ethernet interface
	Serial interface	1; standard RS-485 serial interface, half-duplex		
	USB port	2 × USB2.0		
General	Power supply	12V DC		
	Consumption (without hard disks)	≤ 15W	≤ 20W	≤ 30W
	Working temperature	-10 °C ~ +55 °C (14 °F ~ 131 °F)		
	Working humidity	10% ~ 90%		
	Chassis	1U chassis		380mm 1U chassis
	Dimensions (W × D × H)	315 × 242 × 45mm (12.4 × 9.5 × 1.8 inch)		380 × 290 × 48mm (15.0 × 11.4 × 1.9 inch)
	Weight (without hard disks)	≤ 1.5Kg (3.3lb)		≤ 2Kg (4.4lb)

**Table 2 Specification**

Model		TVR-448+1IP	TVR-896+2IP	TVR-16192+2IP
Video/Audio input	Video compression	H.264		
	Analog and HD-TVI video input	4-ch	8-ch	16-ch
	Supported camera types	720P/25, 720P/30, 720P/50, 720P/60, 1080P/25, 1080P/30, CVBS		
	IP video input	1-ch	2-ch	2-ch
	Audio compression	G.711u		
	Audio input / Two-way audio in	1-ch, RCA (2.0 Vp-p, 1 K $\Omega$ )		
	Video/Audio output	HDMI / VGA output	1920 $\times$ 1080 / 60 Hz, 1280 $\times$ 1024 / 60 Hz, 1280 $\times$ 720 / 60 Hz, 1024 $\times$ 768 / 60 Hz	
Encoding resolution		Main stream: 1080P(non-real-time) / 720P / VGA / WD1 / 4CIF / CIF		
		Sub-stream: WD1(non-real-time) / 4CIF(non-real-time) / CIF / QCIF / QVGA		
Frame rate		Main stream: 1/16 fps ~ Real time frame rate		
		Sub-stream: 1/16 fps ~ Real time frame rate		
Video bitrate		32 Kbps-6 Mbps		
Audio output		1-ch, RCA (Linear, 1K $\Omega$ )		
Audio bitrate		64 Kbps		
Dual-stream		Support		
Stream type		Video, Video & Audio		
Synchronous playback		4-ch	8-ch	16-ch
Playback resolution	1080P / 720P / VGA / WD1 / 4CIF / CIF / QVGA / QCIF			
Network management	Remote connections	128		
	Network protocols	TCP/IP, PPPoE, DHCP, DNS, DDNS, NTP, SADP, SMTP, SNMP, NFS, iSCSI, UPnP™, HTTPS		
Hard disk	SATA	1 SATA interface		2 SATA interfaces
	Capacity	Up to 4 TB capacity for each disk		
External interface	Network interface	1; 10M / 100M self-adaptive Ethernet interface		1; 10M / 100M / 1000M self-adaptive Ethernet interface
	Serial interface	1; standard RS-485 serial interface, half-duplex		
	USB port	2 $\times$ USB2.0		
	Alarm in/out	4/1	8/4	16/4
General	Power supply	12V DC		
	Consumption (without hard disks)	$\leq$ 15W	$\leq$ 20W	$\leq$ 30W
	Working temperature	-10 $^{\circ}$ C ~ +55 $^{\circ}$ C (14 $^{\circ}$ F ~ 131 $^{\circ}$ F)		
	Working humidity	10% ~ 90%		
	Chassis	1U chassis		380mm 1U chassis
	Dimensions (W $\times$ D $\times$ H)	315 $\times$ 242 $\times$ 45mm (12.4 $\times$ 9.5 $\times$ 1.8 inch)		380 $\times$ 290 $\times$ 48mm (15.0 $\times$ 11.4 $\times$ 1.9 inch)
	Weight (without hard disks)	$\leq$ 1.5Kg (3.3lb)		$\leq$ 2Kg (4.4lb)



## HDD Storage Calculation Chart

The following chart shows an estimation of storage space used based on recording at one channel for an hour at a fixed bit rate.

Bit Rate	Storage Used
96K	42M
128K	56M
160K	70M
192K	84M
224K	98M
256K	112M
320K	140M
384K	168M
448K	196M
512K	225M
640K	281M
768K	337M
896K	393M
1024K	450M
1280K	562M
1536K	675M
1792K	787M
2048K	900M
4096K	1800M
8192K	3600M
16384K	7200M



Please note that supplied values for storage space used are just for reference. Storage space used is estimated by formulas and may have some deviation from actual value.

## Accessing by Web Browser

### Logging In

You can get access to the device via web browser. Open web browser, input the IP address of the device and then press Enter. The login interface appears.

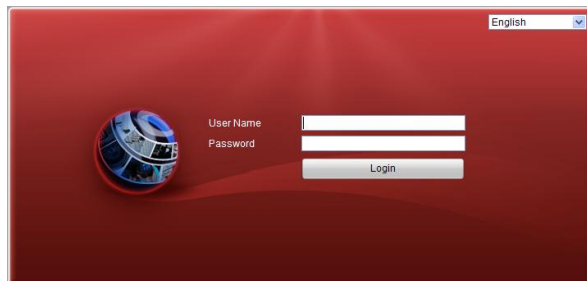

Input the user name and password, and click the **Login** button.



- You may use one of the following listed web browsers: Internet Explorer 6.0, Internet Explorer 7.0, Internet Explorer 8.0, Internet Explorer 9.0, Internet Explorer 10.0, Apple Safari, Mozilla Firefox, and Google Chrome.
- The supported resolutions include 1024\*768 and above.
- The default IP address is 192.0.0.64.
- The default user name is admin, and password is 12345.
- You are highly recommended to change the default password right after the first login to avoid safety problem.

When you log in for the first time, the system will remind you to install the Plug-in control. After the installation, you can configure and manage the device remotely.

### Live View

The live view interface appears by default when you log in the device.

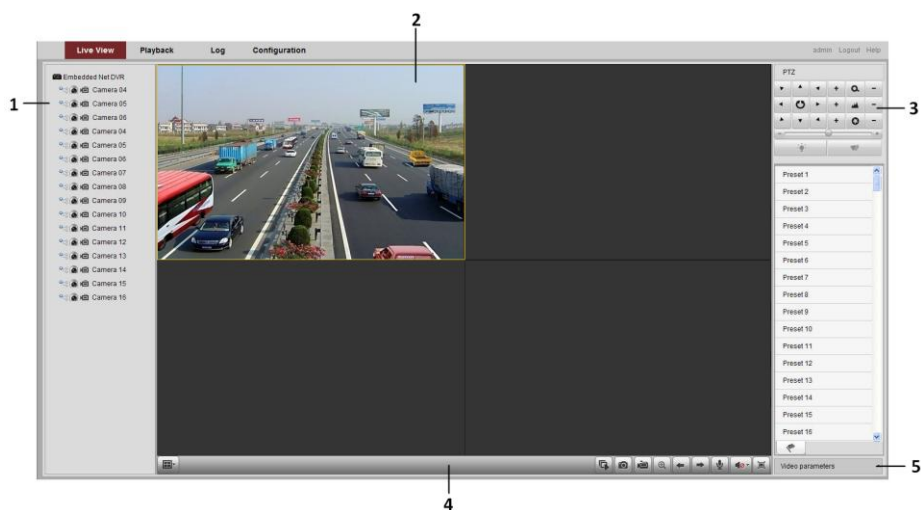

### Interface Introduction

No.	Name	Description
1	Channel List	Displays the list of channels and the playing and recording status of each











No.	Name	Description
		channel.
2	Live View Window	Displays the image of channel, and multi-window division is supported.
3	Play Control Bar	Play control operations are supported.
4	PTZ Control	Pan, tilt, zoom operations are supported, as well as preset editing and calling.  PTZ function can only be realized if the connected camera supports PTZ control.
5	Video Parameters Configuration	Brightness, contrast, saturation and hue of the image can be edited.

### Start Live View

#### Steps:

1. In the live view window, select a playing window by clicking the mouse.
2. Double click a camera from the device list to start the live view.
3. You can click the  button on the toolbar to start the live view of all cameras on the device list.

Refer to the following table for the description of buttons on the live view window:

Icon	Description	Icon	Description
	Select the window-division mode		Previous page
	Start/Stop all live view		Next page
	Capture pictures in the live view mode		Open/Close audio
	Start/Stop all recording		Start/Stop two-way Audio
	Enable/Disable digital zoom		Adjust volume

## Recording

#### Before you start

Make sure the device is connected with HDD or network disk, and the HDD or network disk has been initialized for the first time to use.

Two recording types can be configured: Manual and Scheduled. The following section introduces the configuration of scheduled recording.

#### Steps:

1. Click **Remote Configuration**> **Camera Settings**> **Record Schedule** to enter Record Schedule settings interface.
2. Select the camera to configure the record schedule.
3. Check the checkbox of **Enable Record Schedule** to enable recording schedule.
4. Click **Edit** to edit record schedule.
5. Choose the day in a week to configure scheduled recording.

1) Configure All Day or Customize Record:

- If you want to configure the all-day recording, please check the **All Day** checkbox.
- If you want to record in different time sections, check the **Customize** checkbox. Set the Start Time and End Time.



The time of each segment cannot be overlapped. Up to 8 segments can be configured.

- 2) Select a **Record Type**. The record type can be Continuous, Motion, Alarm, Motion & Alarm, and Motion | Alarm.
  - 3) Check the checkbox of **Select All** and click **Copy** to copy settings of this day to the whole week. You can also check any of the checkboxes before the date and click **Copy**.
  - 4) Click **OK** to save the settings and exit the Edit Schedule interface.
6. Click **Advanced** to configure advanced record parameters.
7. Click **Save** to validate the above settings.

## Playback















### Interface Introduction



No.	Name	Description
1	Channel List	Displays the list of channels and the playing status of each channel.
2	Playback Window	Displays the image of channel.
3	Play Control Bar:	Play control operations are supported.
4	Time Line	Displays the time bar and the records marked with different colors.
5	Playback Status	Displays the playback status, including channel number and playback speed.
6	Calendar	You can select the date to play.

### Start Playback

*Steps:*

1. Click **Playback** on the menu bar to enter playback interface.
2. Click the camera from the device list for playback.
3. Select the date from the calendar and click **Search**.
4. Click the **Play** button to play the video file searched on the current date.
5. Use the buttons on the toolbar to operate in playback mode.

Button	Description	Button	Description
	Play/Pause		Stop
	Slow down		Speed up
	Play by single frame		Capture
	Stop all playback		Download
	Video clip		Open/Close audio
	Full Screen		Reverse play

6. You can drag the progress bar with the mouse to locate the exact playback point. You can also input the time in the textbox  :  :   and click  button to locate the playback point.

The color of the video on the progress bar stands for the different video types.



## Log

You can view and export the log files at any time, including operation, alarm, exception and information of device.

### *Before you start*

The Log function can be realized only when the device is connected with HDD or network disk. And make sure the HDD or network disk has been initialized for the first time to use.

### *Steps:*

1. Click **Log** on the menu bar to enter the Log interface.
2. Set the log search conditions to refine your search, including the Major Type, Minor Type, Start Time and End Time.
3. Click the **Search** button to start searching log files.
4. The matched log files will be displayed on the list shown below.



Up to 100 log files can be displayed on each page.

You can click the  button to save the searched log files to local directory.

# Menu Operation

## Menu Structure

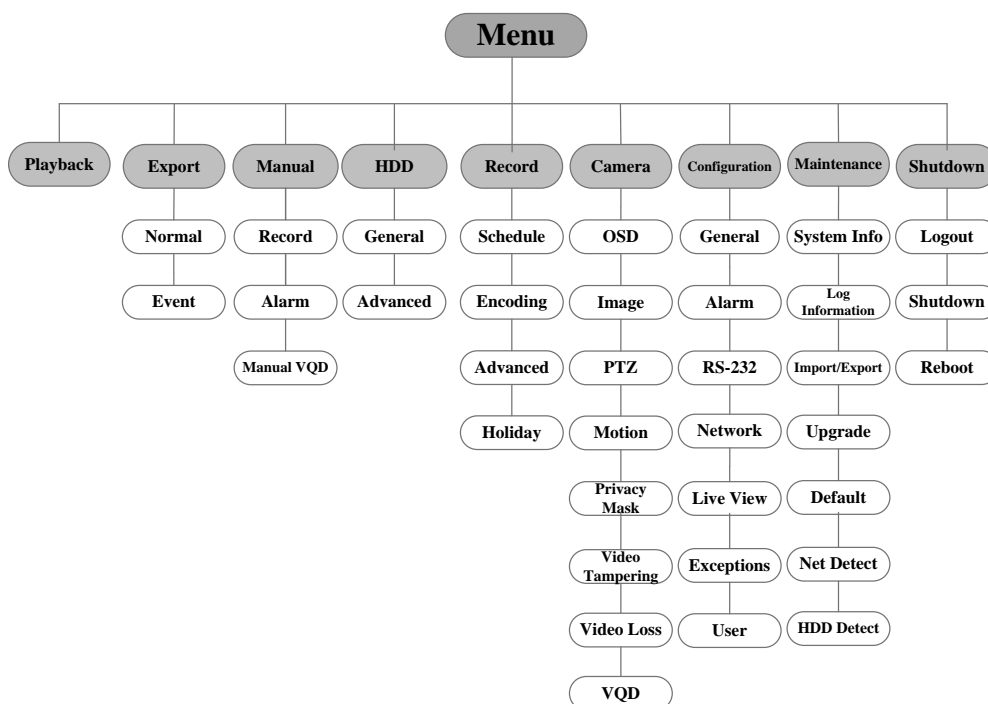

## Startup and Shutdown

Proper startup and shutdown procedures are crucial to expand the service time of the DVR.

### To start the DVR:

Check the power supply is plugged into an electrical outlet. It is **HIGHLY** recommended that an Uninterruptible Power Supply (UPS) be used in conjunction with the device. Turn on the power switch on the rear panel; the Power indicator LED on the front panel should be yellow.

### To shut down the DVR:

*Steps:*

1. Enter the Shutdown menu.  
Menu > Shutdown

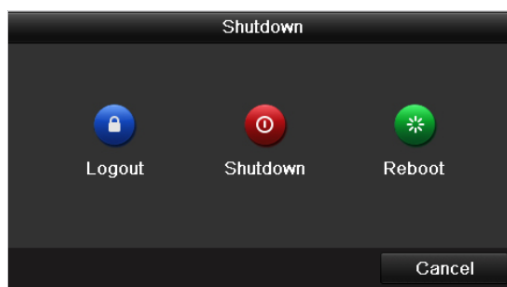

2. Select the **Shutdown** button.
3. Click the **Yes** button.
4. Turn off the power switch on the rear panel when the note appears.

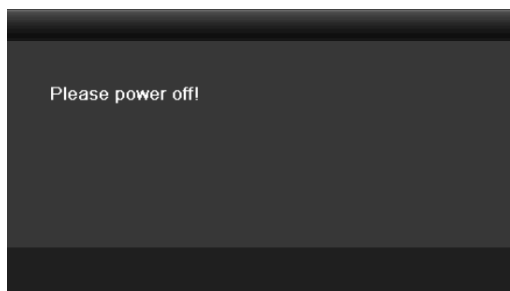

After the device starting up, the wizard will guide you through the basic settings, including editing password, date and time settings, network settings, HDD initializing, and recording.

## Live View

Some icons are provided on screen in Live View mode to indicate different camera status. These icons include:

### Live View Icons

In the live view mode, there are icons at the right top of the screen for each channel, showing the status of the record and alarm in the channel, so that you can find problems as soon as possible.



Indicating that there is an alarm or are alarms. Alarm includes video loss, tampering, motion detection or sensor alarm, etc.



Recording (manual record, continuous record, motion detection or alarm triggered record)

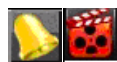

Alarm & Recording



Event/Exception (event and exception information, appears at the lower-left corner of the screen.)

## Adding IP Cameras



The connection of IP cameras is supported by the HDVR only.

For the 1080p Turbo HD DVR, 2 network cameras can be added.

### Steps:

1. Right-click the mouse in the live view mode to show the right-click menu.

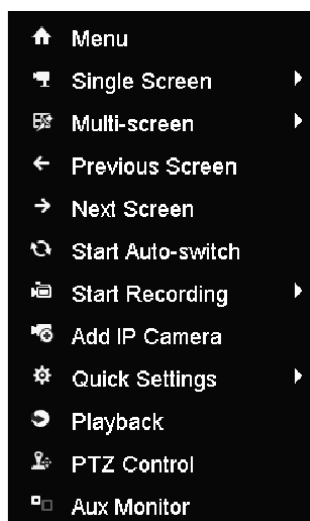

2. Select **Add IP Camera** in the pop-up menu to enter the IP Camera Management interface.

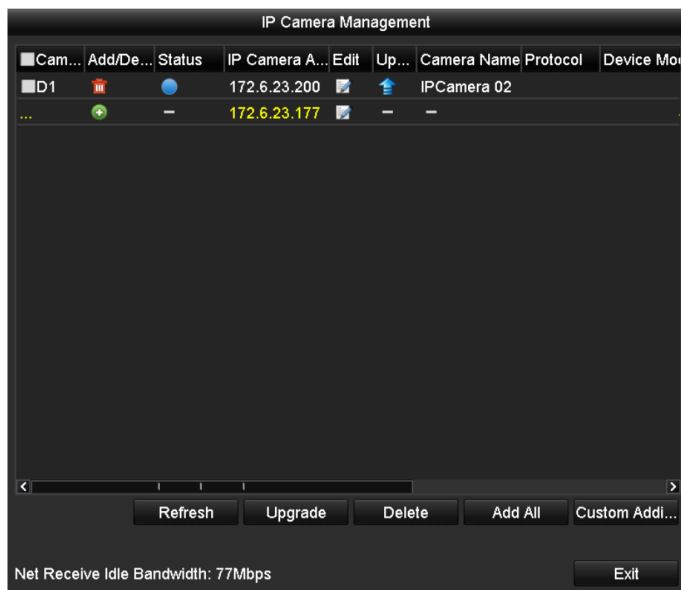







3. The online cameras with same network segment will be displayed in the camera list. Click the  button to add the camera.



The added camera is marked in white while the camera not added is marked in yellow.

Explanation of the icons

Icon	Explanation	Icon	Explanation
	Edit basic parameters of the camera		Add the detected IP camera.
	The camera is connected.		The camera is disconnected; you can click the icon to get the exception information of camera.
	Delete the IP camera.		Advanced settings of the camera.

4. To add other IP cameras:

- 1) Click the **Custom Adding** button to pop up the Add IP Camera (Custom) interface.





- 2) You can edit the IP address, protocol, management port, and other information of the IP camera to be added.
- 3) Click **Add** to add the camera.
- 4) (For the encoders with multiple channels only) check the checkbox of Channel No. in the pop-up window, as shown in the following figure, and click **OK** to finish adding.

## Record

### *Before you start:*

Make sure that the HDD has already been installed. If not, please install a HDD and initialize it. You may refer to the user manual for detailed information.

### *Purpose:*

Two kinds of record types are introduced in the following section, including Instant Record and All-day Record. And for other record types, you may refer to the user manual for detailed information.







After rebooting all the manual records enabled are canceled.

### Instant Recording

On the live view window of each channel, there is a quick setting toolbar which shows on the bottom of the window when you click on it.



Click the  icon to enable the record, and the icon turns to . And click  icon to disable the record, then the icon turns to .

### All-day Recording

Perform the following steps to set the all-day recording.

On the live view window, right click the window and move the cursor to the Start Recording option, and select Continuous Record or Motion Detection Record on your demand.

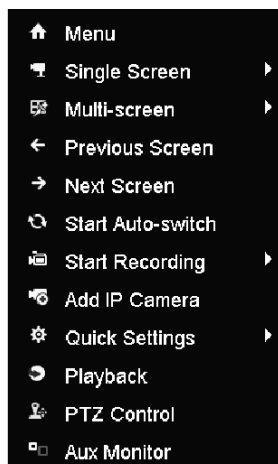

And click the **Yes** button in the popup Attention message box to confirm the settings. Then all the channels will start to record in the selected mode.

## Playback

Play back the record files of a specific channel in the live view menu.

- **OPTION 1:**

Choose a channel under live view using the mouse and click the  button in the shortcut operation menu.



Only record files recorded during the last five minutes on this channel will be played back.



- **OPTION 2:**

1. Enter the Playback menu.

Right click a channel in live view mode and select **Playback** from the menu.



Pressing numerical buttons on the front panel will switch playback to related channels during playback process.

2. Playback management.

The toolbar in the bottom part of Playback interface can be used to control playing process.



Just check the channel or channels if you want to switch playback to another channel or execute simultaneous playback of multiple channels.

## Backup

Recorded files can be backed up to various devices, such as USB flash drives, USB HDDs or USB DVD writers. To export recorded files:

1. Enter Video Export interface.

Choose the channel(s) you want to back up and click the **Quick Export** button.

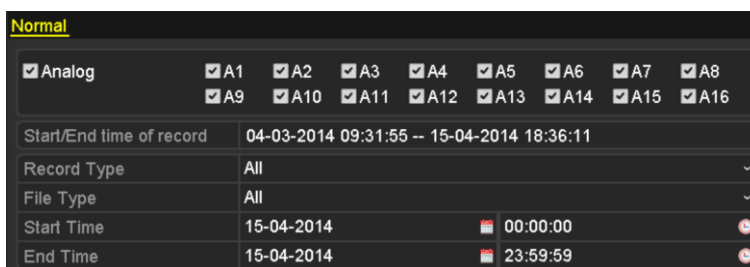

2. Enter Export interface, choose backup device and click the **Export** button to start exporting.

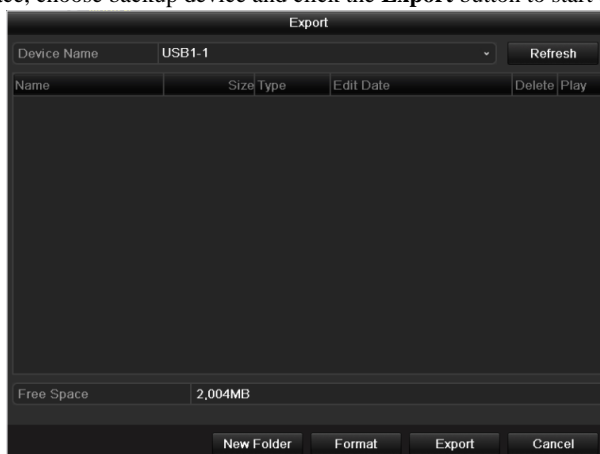

3. Check backup result.

Choose the record file in Export interface and click  button to check it.