

JTS®

Hear The Future.....Now !

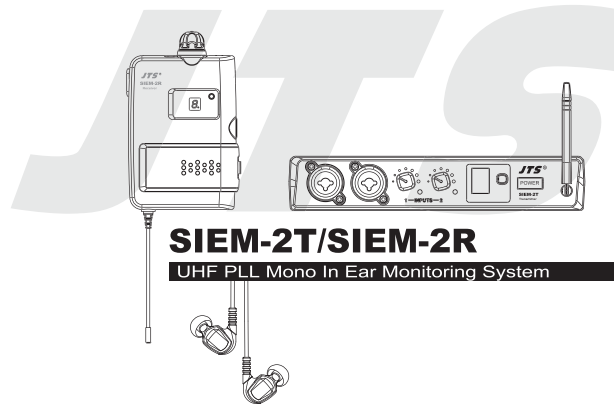

SIEM-2T/SIEM-2R

UHF PLL Mono In Ear Monitoring System

NEW! SIEM-2T/SIEM-2R can select a better earphone, **IE-5** or **IE-6**
with HI-dynamics, HI-definition, Low-noise and Accurate audio reproduction.

FC CE 1856   

59508-031



ATTENTION

Please pay high attention to the following information.

The guideline published by Occupational Safety Health Administration (OSHA) in United States indicates overload volume level for prolonged listening may harm your hearing. Here below are referenced data on maximum time exposure to sound level before hearing injury occurs.

<u>Sound Level (dB)</u>	<u>Duration per day (hrs)</u>
90	8
92	6
95	4
97	3
100	2
102	1.5
105	1
110	0.5
115	0.25
140	Avoid or injury may occur

T ABLE OF CONTENTS

1. Important Cautions	1	5. Preparing Procedures	8
2. Features	1	5-1 SIEM-2T	
3. Specification	3	5-2 SIEM-2R	
3-1 SIEM-2T / SIEM-2R		5-3 Optional Accessory	
3-2 IE-1		6. Basic Operation	13
4. Parts Identification	4	6-1 SIEM-2T	
4-1 SIEM-2T		6-2 SIEM-2R	
4-2 SIEM-2R		7. Installation	17
4-3 Optional Accessory		7-1 Loop Out Application	
		8. Recommendations	19
		9. Important Notice	20

Thank you for choosing the JTS in ear monitoring system. In order to obtain the best efficiency from the system, you are recommended to take a few minutes to read this instruction manual carefully.

1. Important Cautions

- Make all connections before plugging the unit into an AC power outlet.
- Do not leave the devices in a place with high temperature or high humidity.
- Do not handle the power cord with wet hands.
- Keep the devices away from fire and heat sources.
- Avoid prolonged listening at overhigh volume. It may cause injury to your ears.

2. Features

- Developed with JTS advanced wireless technology.
- Wired and wireless design for ambience.
- UHF PLL 16 selectable channels.
- Over 80 meters of stable operation distance.
- Outstanding signal to noise ratio.
- Light weight engineering plastic chassis.
- Built in limit to protect hearing.

3. Specification

3-1 SIEM-2T/SIEM-2R

1. Carrier Frequency Range..... 502~960 MHz
2. RF Output Power..... 10 mW/50mW(depending on local regulation)
3. Nominal Frequency Deviation \pm 40KHz (modulation).....
4. Audio Input Impedance..... 20k Ω
5. Nominal Input Level..... -20 dBV
6. Maximal Input Level.....0 dBV
7. LED Display.....AF Level, Channel
8. Audio Input Connector..... 2 x Balanced XLR
9. Loop Out Connector..... 2 x \varnothing 6.3mm Balanced Loop Out Socket
- 10.Operation Voltage..... 12-18 VDC, 300 mA

3-2 IE-1

Frequency Response	10 ~ 20,000 Hz
Transducer Type	Dynamic
Impedance	16 Ω
Sensitivity (at 1 kHz)	114 dB/mW
Distortion	Less than 0.3 %
Cord Length	58"
Net Weight	6 g (cable excluded)

4. Parts Identification

4-1 SIEM-2T

Front Panel

- ① Power Switch
- ② Channel LED Display
- ③ Mic.1 / LINE IN Volume Control
- ④ Mic.2 / LINE IN Volume Control
- ⑤ Mic.1 / LINE IN (Input Combo)
- ⑥ Mic.2 / LINE IN (Input Combo)
- ⑦ AF PEAK Display
- ⑧ Set Switch
- ⑨ Antenna

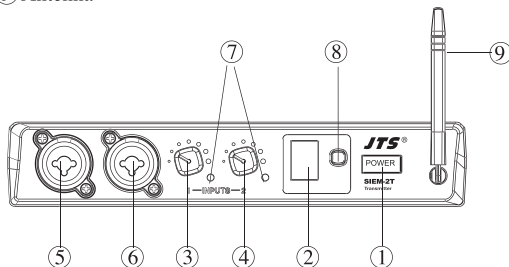

Rear Panel

- ① DC Input (12V~18V)
- ② TX Boost
- ③ Mic.1 / LINE IN LOOP OUT
- ④ Mic.2 / LINE IN LOOP OUT

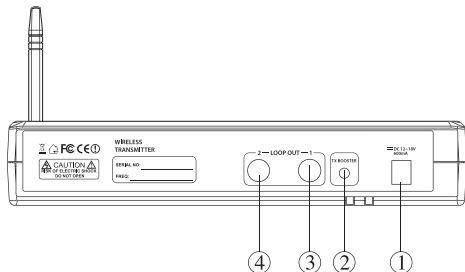

4-2 SIEM-2R

- ① Antenna
- ② Power Switch and Volume Control
- ③ Channel Selector
- ④ Channel LED Display
- ⑤ 6.3mm Mic/ Line In
- ⑥ Battery Tray
- ⑦ Volume Limiter/Gate ON/ OFF
- ⑧ Line In Gain Control
- ⑨ Belt Clip
- ⑩ Ø3.5mm Phone Jack
- ⑪ Power ON/Low Battery Indicator

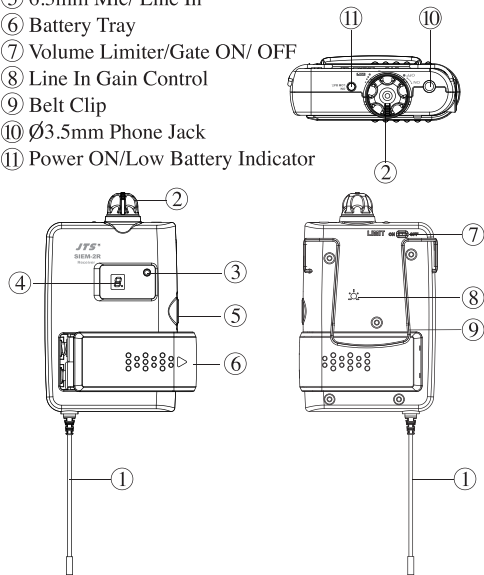

4-3 Accessory

1. IE-1

- ① Earphone
- ② Silicon Sleeve
- ③ Cord
- ④ 1/8" Stereo Phone Plug
- ⑤ Case

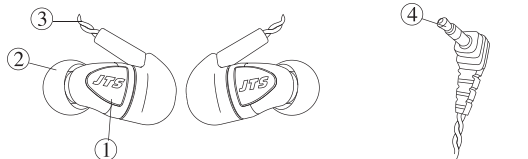

2. Power Supply

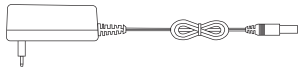

2. DR-900(Optional)

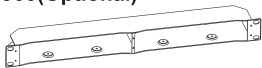

5. Preparing Procedures

5-1 SIEM-2T

1. Set the rubber pad

Four self-adhesive rubber pads are provided to ensure the stability. They are to be placed on the bottom of the transmitter.

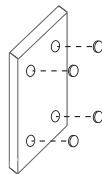

2. Connect the audio source, such as a mixer.

Connect the mixer output to the XLR / ϕ 6.3mm combo input in the Front panel of SIEM-2T with the AF input cable.

NOTE: Two balanced XLR / ϕ 6.3mm combo inputs are provided. You may use either one or both for a stereo source. Also, two balanced ϕ 6.3mm loop out connectors are provided for multiple systems application.

(Figure A / P9)

3. Power connection.

Connect one end of AC/DC adaptor cable to DC input socket in the rear panel of the receiver, and plug another end into an AC outlet. (Figure B)

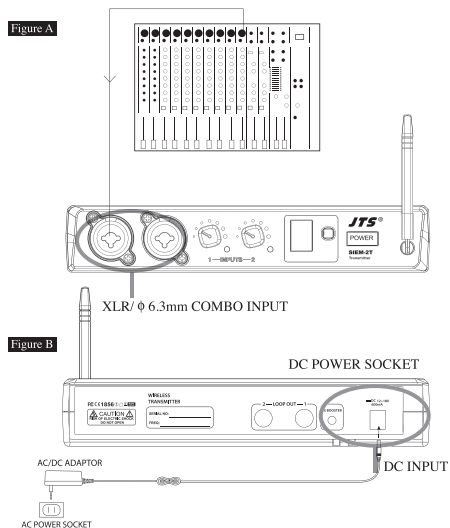

5-2 SIEM-2R

1. Insert and replace batteries

- (1) Slide the lid of battery tray. (Figure 1)
- (2) Uncover the lid and insert two pieces of 1.5V AA batteries according to the polarity indication. (Figure 2)
- (3) Cover back the lid. (Figure 3)

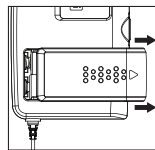

Figure 1

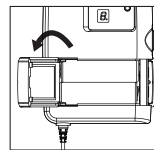

Figure 2

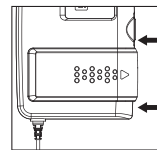

Figure 3